



Interface and Hardware Component Configuration Guide, Cisco IOS XE Fuji 16.9.x

First Published: 2018-07-25

Americas Headquarters

Cisco Systems, Inc.
170 West Tasman Drive
San Jose, CA 95134-1706
USA
<http://www.cisco.com>
Tel: 408 526-4000
800 553-NETS (6387)
Fax: 408 527-0883



CONTENTS

CHAPTER 1

Read Me First 1

CHAPTER 2

mGRE Tunnel Support over IPv6 3

Finding Feature Information 3

Information About mGRE Tunnel Support over IPv6 3

mGRE Support over IPv6 3

How to Configure mGRE Tunnel Support over IPv6 4

Configuring mGRE Tunnel Support over IPv6 4

Verifying mGRE Tunnel Support over IPv6 6

Configuration Example for mGRE Tunnel over IPv6 8

Example for mGRE Tunnel over IPv6 8

Additional References 10

Feature Information for mGRE Tunnel Support over IPv6 11

CHAPTER 3

IP over IPv6 Tunnels 13

Information About IP over IPv6 Tunnels 13

GRE IPv4 Tunnel Support for IPv6 Traffic 13

GRE Support over IPv6 Transport 14

How to Configure IP over IPv6 Tunnels 14

Configuring GRE IPv6 Tunnels 14

Configuration Examples for IP over IPv6 Tunnels 15

Example: IPv6 over IPv6 Tunnel 15

Example: IPv4 over IPv6 Tunnel 18

Additional References 20

Feature Information for IP over IPv6 Tunnels 21

CHAPTER 4	Manually Configured IPv6 over IPv4 Tunnels	23
	Finding Feature Information	23
	Information About Manually Configured IPv6 over IPv4 Tunnels	23
	Overlay Tunnels for IPv6	23
	IPv6 Manually Configured Tunnels	25
	How to Enable Manually Configured IPv6 over IPv4 Tunnels	26
	Configuring Manual IPv6 Tunnels	26
	Configuration Examples for Manually Configured IPv6 over IPv4 Tunnels	27
	Example: Configuring Manual IPv6 Tunnels	27
	Example: IPv6 over GRE IPv4 Tunnel	28
	Additional References	31
	Feature Information for Manually Configured IPv6 over IPv4 Tunnels	32

CHAPTER 5	Configuring Physical Interfaces	33
	Finding Feature Information	33
	Configuration Information	33
	Command Reference Information	34

CHAPTER 6	Configuring Virtual Interfaces	35
	Finding Feature Information	35
	Prerequisites for Configuring Virtual Interfaces	35
	Information About Configuring Virtual Interfaces	36
	Virtual Interfaces	36
	Benefits of Virtual Interfaces	36
	Loopback Interfaces	37
	Loopback Interfaces Versus Loopback Mode	38
	Null Interfaces	38
	Subinterfaces	39
	Tunnel Interfaces	39
	How to Configure Virtual Interfaces	40
	Configuring a Loopback Interface	40
	Configuring a Null Interface	42
	ICMP Unreachable Messages from Null Interfaces	42

Configuring a Subinterface	43
Configuring a Subinterface	45
Configuring Logical Layer 3 VLAN Interfaces	47
Configuration Examples for Virtual Interfaces	48
Example Configuring a Loopback Interface	48
Example Configuring a Null Interface	48
Example Configuring a Subinterface	48
Where to Go Next	49
Additional References	49

CHAPTER 7**Implementing Tunnels 51**

Finding Feature Information	51
Restrictions for Implementing Tunnels	51
Information About Implementing Tunnels	52
Tunneling Versus Encapsulation	52
Tunnel ToS	53
EoMPLS over GRE	53
Provider Edge to Provider Edge Generic Routing Encapsulation Tunnels	54
Provider to Provider Generic Routing Encapsulation Tunnels	54
Provider Edge to Provider Generic Routing Encapsulation Tunnels	54
Features Specific to Generic Routing Encapsulation	54
Features Specific to Ethernet over MPLS	55
Features Specific to Multiprotocol Label Switching Virtual Private Network	55
Path MTU Discovery	55
QoS Options for Tunnels	56
How to Implement Tunnels	56
Determining the Tunnel Type	56
Configuring an IPv4 GRE Tunnel	57
GRE Tunnel Keepalive	57
What to Do Next	60
Configuring 6to4 Tunnels	61
What to Do Next	62
Verifying Tunnel Configuration and Operation	63
Configuration Examples for Implementing Tunnels	65

Example: Configuring a GRE IPv4 Tunnel 65

Example: Configuring EoMPLS over GRE 66

Configuring QoS Options on Tunnel Interfaces Examples 68

 Policing Example 68

Additional References 69

Feature Information for Implementing Tunnels 71

CHAPTER 8

Tunnel Route Selection 73

Finding Feature Information 73

Prerequisites for Tunnel Route Selection 73

Restrictions for Tunnel Route Selection 73

Information About Tunnel Route Selection 74

 Tunnel Transport Behavior 74

How to Configure Tunnel Route Selection 75

 Configuring Tunnel Route Selection 75

 Troubleshooting Tips 76

 What to Do Next 76

Configuration Examples for Tunnel Route Selection 76

 Example Configuring Tunnel Route Selection 76

Additional References 77

Feature Information for Tunnel Route Selection 77

CHAPTER 9

MPLS VPN over mGRE 79

Finding Feature Information 79

Prerequisites for MPLS VPN over mGRE 79

Restrictions for MPLS VPN over mGRE 80

Information About MPLS VPN over mGRE 80

 MPLS VPN over mGRE 81

 Route Maps 81

 Tunnel Endpoint Discovery and Forwarding 81

 Tunnel Decapsulation 82

 Tunnel Source 82

 IPv6 VPN 82

How to Configure MPLS VPN over mGRE 82

Configuring an L3VPN Encapsulation Profile	82
Configuring BGP and Route Maps	84
Configuration Examples for MPLS VPN over mGRE	88
Example Verifying the MPLS VPN over mGRE Configuration	88
Example Configuration Sequence for MPLS VPN over mGRE	89
Additional References	90
Feature Information for MPLS VPN over mGRE	91

CHAPTER 10**IP Tunnel MIBs 93**

Finding Feature Information	93
Prerequisites for the IP Tunnel MIB	93
Restrictions for the IP Tunnel MIB	94
Information About the IP Tunnel MIB	94
Benefits of the IP Tunnel MIB	94
MIB Objects Supported by the IP Tunnel MIB	94
How to Configure SNMP and Use the IP Tunnel MIB	96
Configuring the Router to Use SNMP	96
What to Do Next	97
Additional References	97
Feature Information for the Tunnel MIB	98

CHAPTER 11**IF-MIBs 101**

Finding Feature Information	101
Prerequisites for Using the IF-MIB	102
Information About the IF-MIB	102
Benefits of the IF-MIB	102
How to Enable IETF-Compliant Link Traps for SNMP	103
Verifying IETF-Compliant Link Traps for SNMP	104
Troubleshooting Tips	104
Example to Enable IETF-Compliant Link Traps for SNMP	104
How to Configure SNMP and Use the IF-MIB	105
Configuring the Router to Use SNMP	105
What to Do Next	106
Additional References	106

Feature Information for IF-MIBs 107

CHAPTER 12

Synchronous Ethernet (SyncE) ESMC and SSM 109

Finding Feature Information 109

Prerequisites for Synchronous Ethernet (SyncE) ESMC and SSM 110

Restrictions for Synchronous Ethernet (SyncE) ESMC and SSM 110

Information About Synchronous Ethernet (SyncE) ESMC and SSM 110

Synchronous Ethernet (SyncE) ESMC and SSM 110

How to Configure Synchronous Ethernet (SyncE) ESMC and SSM 111

Configuring SyncE 111

Enabling and Disabling an SNMP Trap in the SyncE Event 115

Configuration Examples for Synchronous Ethernet (SyncE) ESMC and SSM 116

Example Synchronous Ethernet (SyncE) ESMC and SSM 116

Example Enabling and Disabling an SNMP Trap in the SyncE Event 118

Additional References 119

Feature Information for Synchronous Ethernet (SyncE) ESMC and SSM 120

CHAPTER 13

1+1 SR-APS Without Bridging 121

Finding Feature Information 121

Prerequisites for 1+1 SR-APS Without Bridging 121

Restrictions for 1+1 SR-APS Without Bridging 122

Information About 1+1 SR-APS Without Bridging 122

1+1 SR-APS Without Bridging 122

How to Configure 1+1 SR-APS Without Bridging 123

Configuring APS Working and Protect Interfaces 123

Configuring Other APS Options 124

Monitoring and Maintaining APS 125

Configuring SONET Alarm Reporting 126

Configuring LAIS as an APS Switchover Trigger 127

Configuration Examples for 1+1 SR-APS Without Bridging 129

Example Configuring 1+1 SR-APS Without Bridging 129

Additional References 131

Feature Information for 1+1 SR-APS Without Bridging 132

CHAPTER 14	IPv6 Rapid Deployment	133
	Finding Feature Information	133
	Information About IPv6 Rapid Deployment	133
	IPv6 Rapid Deployment Tunnels	133
	How to Configure IPv6 Rapid Deployment	135
	Configuring 6RD Tunnels	135
	Configuration Examples for IPv6 Rapid Deployment	137
	Example: Configuring 6RD Tunnels	137
	Additional References	137
	Feature Information for IPv6 Rapid Deployment	138

CHAPTER 15	IPv6 Automatic 6to4 Tunnels	139
	Finding Feature Information	139
	Information About IPv6 Automatic 6to4 Tunnels	139
	Automatic 6to4 Tunnels	139
	How to Configure IPv6 Automatic 6to4 Tunnels	140
	Configuring Automatic 6to4 Tunnels	140
	Configuration Examples for IPv6 Automatic 6to4 Tunnels	142
	Example: Configuring 6to4 Tunnels	142
	Additional References	142
	Feature Information for IPv6 Automatic 6to4 Tunnels	143

CHAPTER 16	IPv6 over IPv4 GRE Tunnels	145
	Finding Feature Information	145
	Information About IPv6 over IPv4 GRE Tunnels	145
	Overlay Tunnels for IPv6	145
	GRE IPv4 Tunnel Support for IPv6 Traffic	147
	How to Configure IPv6 over IPv4 GRE Tunnels	148
	Configuring GRE on IPv6 Tunnels	148
	Configuration Examples for IPv6 over IPv4 GRE Tunnels	149
	Example GRE Tunnel Running IS-IS and IPv6 Traffic	149
	Example: Tunnel Destination Address for IPv6 Tunnel	150
	Additional References	151

Feature Information for IPv6 over IPv4 GRE Tunnels 152

CHAPTER 17

GRE IPv6 Tunnels 153

Finding Feature Information 153

Restrictions for GRE IPv6 Tunnels 153

Information About GRE IPv6 Tunnels 154

 Overview of GRE IPv6 Tunnels 154

 GRE IPv6 Tunnel Protection 154

How to Configure GRE IPv6 Tunnels 154

 Configuring GRE IPv6 Tunnels 154

 Configuring GRE IPv6 Tunnel Protection 155

Configuration Examples for GRE IPv6 Tunnels 157

 Example: Configuring GRE IPv6 Tunnels 157

 Example: Configuring GRE IPv6 Tunnel Protection 157

Information About EoMPLS over IPv6 GRE Tunnel 157

 Configuring EoMPLS over IPv6 GRE Tunnel 158

 Using Legacy Commands 158

 Using Protocol-based Commands 160

 Verifying the EoMPLS over IPv6 GRE Tunnel Configuration 162

Additional References 165

Feature Information for GRE IPv6 Tunnels 165

CHAPTER 18

ISATAP Tunnel Support for IPv6 167

Finding Feature Information 167

Information About ISATAP Tunnel Support for IPv6 167

 Overlay Tunnels for IPv6 167

 ISATAP Tunnels 169

How to Configure ISATAP Tunnel Support for IPv6 170

 Configuring ISATAP Tunnels 170

Configuration Examples for ISATAP Tunnel Support for IPv6 171

 Example: Configuring ISATAP Tunnels 171

Additional References 172

Feature Information for ISATAP Tunnel Support for IPv6 172

CHAPTER 19	VRF-Aware Tunnels	175
	Finding Feature Information	175
	Prerequisites for VRF-Aware Tunnels	175
	Information About VRF-Aware Tunnels	176
	Tunnel IP Source and Destination VRF Membership	176
	VRF-Aware Tunnels	176
	VRF-Aware IPv6 over IPv6 Tunnels	176
	VRF-Aware IPv4 over IPv6 Tunnels	177
	VRF-Aware IPv6 over IPv4 Tunnels	177
	How to Configure VRF-Aware IPv6 Tunnels	177
	Configuring a VRF-Aware Tunnel	177
	Defining a VRF Instance	180
	Configuring Customer Edge Networks for Tunneling	181
	Verifying VRF-Aware Tunnels	182
	Configuration Examples for VRF-Aware Tunnels	185
	Example: Configuring a VRF-Aware Tunnel (Tunnel Endpoint in Global Routing Table)	185
	Example: Configuring a VRF-Aware Tunnel (Tunnel Endpoint in VRF)	189
	Additional References	193
	Feature Information for VRF-Aware Tunnels	194
CHAPTER 20	Ethernet over GRE Tunnels	195
	Finding Feature Information	195
	Restrictions for Ethernet over GRE Tunnels	195
	Information About Ethernet over GRE Tunnels	196
	Ethernet over GRE Tunnels Supported Functionality	199
	Virtual MAC Address	200
	VLAN on the Tunnel Interface	200
	How to Configure an Ethernet over GRE tunnel	201
	Configuring an Ethernet over GRE Tunnel	201
	Verifying Ethernet Over GRE Tunnel	202
	Configuration Examples for Ethernet over GRE Tunnels	204
	Example: Configuring Ethernet over GRE Tunnels	204
	Additional References	205

Feature Information for Ethernet over GRE Tunnels 206

CHAPTER 21

QoS on Ethernet over GRE Tunnels 207

Finding Feature Information 207

Information About QoS on Ethernet over GRE Tunnels 207

EoGRE Downstream QoS 207

Single SSID 208

Multiple SSIDs 208

How to Configure QoS on Ethernet over GRE Tunnels 209

Configuring Downstream QoS Policy on Ethernet over GRE Tunnels 209

Verifying QoS on Ethernet over GRE Tunnels 211

Configuration Examples for QoS on Ethernet over GRE Tunnels 213

Example: QoS on Ethernet over GRE Tunnels 213

Additional References for QoS on Ethernet over GRE Tunnels 215

Feature Information for QoS on Ethernet over GRE Tunnels 215

CHAPTER 22

VRF-Aware IPv6 Rapid Deployment Tunnel 217

Finding Feature Information 217

Restrictions for the VRF-Aware IPv6 Rapid Deployment Tunnel 217

Information About the VRF-Aware IPv6 Rapid Deployment Tunnel 218

How to Configure the VRF-Aware IPv6 Rapid Deployment Tunnel 218

Configuring the VRF-Aware IPv6 Rapid Deployment Tunnel 219

Additional References 226

Feature Information for the VRF-Aware IPv6 Rapid Deployment Tunnel 227

CHAPTER 23

IP Tunnel - GRE Key Entropy Support 229

Finding Feature Information 229

Prerequisites for IP Tunnel - GRE Key Entropy Support 229

Restrictions for IP Tunnel - GRE Key Entropy Support 229

Information About IP Tunnel - GRE Key Entropy Support 230

IP Tunnel - GRE Key Entropy Support Overview 230

How To Configure IP Tunnel - GRE Key Entropy Support 230

Configuring IP Tunnel - GRE Key Entropy Support 230

Configuration Examples for IP Tunnel - GRE Key Entropy Support 232

Examples: Configuring IP Tunnel - GRE Key Entropy Support	232
Additional References for IP Tunnel - GRE Key Entropy Support	233
Feature Information for IP Tunnel - GRE Key Entropy Support	234



CHAPTER 1

Read Me First

Important Information about Cisco IOS XE 16

Effective Cisco IOS XE Release 3.7.0E for Catalyst Switching and Cisco IOS XE Release 3.17S (for Access and Edge Routing) the two releases evolve (merge) into a single version of converged release—the Cisco IOS XE 16—providing one release covering the extensive range of access and edge products in the Switching and Routing portfolio.

Feature Information

Use [Cisco Feature Navigator](#) to find information about feature support, platform support, and Cisco software image support. An account on Cisco.com is not required.

Related References

- [Cisco IOS Command References, All Releases](#)

Obtaining Documentation and Submitting a Service Request

- To receive timely, relevant information from Cisco, sign up at [Cisco Profile Manager](#).
- To get the business impact you're looking for with the technologies that matter, visit [Cisco Services](#).
- To submit a service request, visit [Cisco Support](#).
- To discover and browse secure, validated enterprise-class apps, products, solutions and services, visit [Cisco Marketplace](#).
- To obtain general networking, training, and certification titles, visit [Cisco Press](#).
- To find warranty information for a specific product or product family, access [Cisco Warranty Finder](#).



CHAPTER 2

mGRE Tunnel Support over IPv6

The mGRE Tunnel Support over IPv6 feature enables service providers to deploy IPv6 in their core infrastructure.

- [Finding Feature Information, on page 3](#)
- [Information About mGRE Tunnel Support over IPv6, on page 3](#)
- [How to Configure mGRE Tunnel Support over IPv6, on page 4](#)
- [Configuration Example for mGRE Tunnel over IPv6, on page 8](#)
- [Additional References, on page 10](#)
- [Feature Information for mGRE Tunnel Support over IPv6, on page 11](#)

Finding Feature Information

Your software release may not support all the features documented in this module. For the latest caveats and feature information, see [Bug Search Tool](#) and the release notes for your platform and software release. To find information about the features documented in this module, and to see a list of the releases in which each feature is supported, see the feature information table.

Use Cisco Feature Navigator to find information about platform support and Cisco software image support. To access Cisco Feature Navigator, go to www.cisco.com/go/cfn. An account on Cisco.com is not required.

Information About mGRE Tunnel Support over IPv6

mGRE Support over IPv6

Multiple sites of a Dynamic Multipoint Virtual Private Network (DMVPN) are interconnected by IPv6. A single logical multipoint generic routing encapsulation (mGRE) tunnel interface interconnects one VPN site to another. An IPv6 subnet connects a tunnel interface with other tunnel interfaces from various VPN sites. All tunnel interfaces connecting VPN sites act as hosts on the logical IPv6 subnet. This structure is referred to as the tunnel overlay network.

To enable service providers deploy IPv6 in their core infrastructure, mGRE tunnels over IPv6 are supported. DMVPN customers may run either IPv4 or IPv6 in their local networks, so the overlay endpoints can be either IPv4 or IPv6. For an IPv6 transport endpoint, the overlay endpoint can either be an IPv4 or IPv6 private network address.

GRE has a protocol field that identifies the passenger protocol. GRE tunnels allow Intermediate System-to-Intermediate System (IS-IS) or IPv6 to be specified as a passenger protocol, which allows both IS-IS and IPv6 traffic to run over the same tunnel. If GRE did not have a protocol field, it would be impossible to distinguish whether the tunnel was carrying IS-IS or IPv6 packets.

How to Configure mGRE Tunnel Support over IPv6

Configuring mGRE Tunnel Support over IPv6

Perform this task on the hub and spoke device of the multipoint generic routing encapsulation (mGRE) tunnel.

Before you begin

Create a Next Hop Resolution Protocol (NHRP) ID to configure on a multipoint generic routing encapsulation (mGRE) tunnel.

For more information on configuring NHRP, see the “How to Configure NHRP” topic in the *IP Addressing : NHRP Configuration Guide*.

SUMMARY STEPS

1. **enable**
2. **configure terminal**
3. **ipv6 unicast-routing**
4. **interface tunnel** *tunnel-number*
5. **description** *description-string*
6. **ipv6 address** *ip-address mask*
7. **ipv6 nhrp map multicast dynamic**
8. **ipv6 nhrp network-id** *network-id*
9. **ipv6 nhrp holdtime** *seconds*
10. **ipv6 nhrp nhs** *ipv6- nhs-address*
11. **tunnel source** *ip-address | ipv6-address | interface-type | interface-number*
12. **tunnel mode gre multipoint ipv6**
13. **end**

DETAILED STEPS

	Command or Action	Purpose
Step 1	enable Example: Device> enable	Enables privileged EXEC mode. <ul style="list-style-type: none"> • Enter your password if prompted.
Step 2	configure terminal Example: Device# configure terminal	Enters global configuration mode.

	Command or Action	Purpose
Step 3	ipv6 unicast-routing Example: Device(config)# ipv6 unicast-routing	Enables forwarding of IPv6 unicast datagrams.
Step 4	interface tunnel tunnel-number Example: Device(config)# interface tunnel 1	Configures a tunnel interface and enters interface configuration mode. <ul style="list-style-type: none"> The <i>tunnel-number</i> argument specifies the number of tunnel interfaces that you can create or configure. There is no limit on the number of tunnel interfaces that you can configure.
Step 5	description description-string Example: Device(config-if)# description DMVPN HUB	Configures information specific to the interface.
Step 6	ipv6 address ip-address mask Example: Device(config-if)# ipv6 address 2001:0DB8:0C18:2::300/64	Specifies the IPv6 address and mask of the hub.
Step 7	ipv6 nhrp map multicast dynamic Example: Device(config-if)# ipv6 nhrp map multicast dynamic	Enables NHRP to initiate multipoint GRE tunnels to register their unicast NHRP mappings.
Step 8	ipv6 nhrp network-id network-id Example: Device(config-if)# ipv6 nhrp network-id 100	Configures NHRP on an interface. The IPv6 NHRP network-id is a unique 32-bit network identifier from a nonbroadcast multiaccess (NBMA) network. The range is from 1 to 4294967295.
Step 9	ipv6 nhrp holdtime seconds Example: Device(config-if)# ipv6 nhrp holdtime 100	Configures the time in seconds that NBMA addresses are advertised as valid in NHRP response.
Step 10	ipv6 nhrp nhs ipv6-nhs-address Example: Device(config-if)# ipv6 nhrp nhs 1101:1::1	Specifies IPv6 prefix of one or more NHRP servers.
Step 11	tunnel source ip-address ipv6-address interface-type interface-number Example: Device(config-if)# tunnel source ethernet 0	Configures the source address of a tunnel interface.
Step 12	tunnel mode gre multipoint ipv6 Example: Device(config-if)# tunnel mode gre multipoint ipv6	Sets the encapsulation mode of the tunnel to mGRE IPv6.

	Command or Action	Purpose
Step 13	end Example: Device(config-if)# end	Exits to global configuration mode.

What to do next

Verify the mGRE tunnel over IPv6.

Verifying mGRE Tunnel Support over IPv6

The **show** commands can be entered in any order.

Before you begin

Configure mGRE tunnel over IPv6.

SUMMARY STEPS

1. **show interface tunnel** *tunnel-interface*
2. **show tunnel endpoints tunnel** *tunnel-interface*
3. **show ipv6 traffic**

DETAILED STEPS

Step 1 **show interface tunnel** *tunnel-interface*

This command displays information about the tunnel.

Example:

```
Device# show interface tunnel 1

Tunnel1 is up, line protocol is down
Hardware is Tunnel
Description: DMVPN Spoke 1
MTU 1456 bytes, BW 100 Kbit/sec, DLY 50000 usec,
reliability 255/255, txload 1/255, rxload 1/255
Encapsulation TUNNEL, loopback not set
Keepalive not set
Tunnel linstat evaluation down - transport reg down
Tunnel source Ethernet1/0
Tunnel Subblocks:
src-track:
Tunnel1 source tracking subblock associated with Ethernet1/0
Set of tunnels with source Ethernet1/0, 1 member (includes iterators), on interface <OK>
Tunnel protocol/transport multi-GRE/IPv6
Key disabled, sequencing disabled
Checksumming of packets disabled
Tunnel TTL 255
Tunnel transport MTU 1456 bytes
Tunnel transmit bandwidth 8000 (kbps)
Tunnel receive bandwidth 8000 (kbps)
```

Last input never, output never, output hang never

Step 2 **show tunnel endpoints tunnel** *tunnel-interface*

This command displays tunnel interface endpoints and verifies if the tunnel is created correctly.

Example:

```
Device# show tunnel endpoints tunnel 1

Tunnel 1 running in multi-GRE/IPv6 mode
Endpoint transport 1101:2::1 Refcount 3 Base 0x2B83A87F83D8 Create Time 00:22:05
overlay 1101:1::1 Refcount 2 Parent 0x2B83A87F83D8 Create Time 00:22:05
Tunnel Subblocks:
tunnel-nhrp-sb:
NHRP subblock has 1 entries
```

Step 3 **show ipv6 traffic**

This command displays statistics about IPv6 traffic on a tunnel.

Example:

```
Device# show ipv6 traffic

IPv6 statistics:
  Rcvd: 46 total, 34 local destination
        0 source-routed, 0 truncated
        0 format errors, 0 hop count exceeded
        0 bad header, 0 unknown option, 0 bad source
        0 unknown protocol, 0 not a router
        0 fragments, 0 total reassembled
        0 reassembly timeouts, 0 reassembly failures
  Sent: 54 generated, 0 forwarded
        0 fragmented into 0 fragments, 0 failed
        8 encapsulation failed, 0 no route, 0 too big
        0 RPF drops, 0 RPF suppressed drops
  Mcast: 22 received, 21 sent

ICMP statistics:
  Rcvd: 37 input, 0 checksum errors, 0 too short
        0 unknown info type, 0 unknown error type
        unreachable: 0 routing, 0 admin, 0 neighbor, 0 address, 0 port
                   0 sa policy, 0 reject route
        parameter: 0 error, 0 header, 0 option
        0 hopcount expired, 0 reassembly timeout, 0 too big
        0 bad embedded ipv6
        10 echo request, 0 echo reply
        0 group query, 0 group report, 0 group reduce
        0 router solicit, 7 router advert, 0 redirects
        4 neighbor solicit, 6 neighbor advert
  Sent: 47 output, 0 rate-limited
        unreachable: 0 routing, 0 admin, 0 neighbor, 0 address, 0 port
                   0 sa policy, 0 reject route
        parameter: 0 error, 0 header, 0 option
        0 hopcount expired, 0 reassembly timeout, 0 too big
        0 echo request, 10 echo reply
        0 group query, 0 group report, 0 group reduce
        3 router solicit, 7 router advert, 0 redirects
        6 neighbor solicit, 6 neighbor advert

UDP statistics:
```

```
Rcvd: 0 input, 0 checksum errors, 0 length errors
      0 no port, 0 dropped
Sent: 0 output
```

TCP statistics:

```
Rcvd: 0 input, 0 checksum errors
Sent: 0 output, 0 retransmitted
```

Configuration Example for mGRE Tunnel over IPv6

Example for mGRE Tunnel over IPv6

mGRE Tunnel over IPv6

Configuring mGRE tunnel over IPv6 transport.

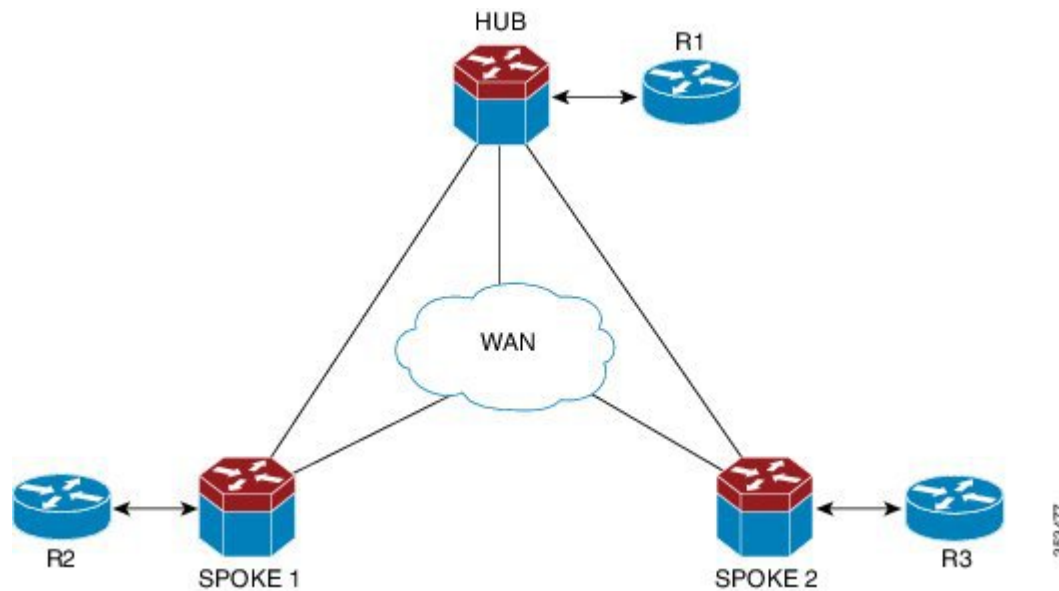

! Configure the topology

```
R1(config)# ipv6 unicast-routing
R1(config)# ipv6 cef
R1(config)# interface Ethernet0/1
R1(config-if)# ipv6 address 2001:DB8:1111:1111::1/64
R1(config-if)# no shutdown
R1(config-if)# exit
R1(config)# ipv6 route ::/0 2001:DB8:1111:1111::2
```

! Configure the tunnel interface on hub

```
Hub(config)# ipv6 unicast-routing
Hub(config)# interface tunnel 1
Hub(config-if)# description DMVPN HUB
Hub(config-if)# ipv6 address 2001:DB8:1111:4444::1/64
```

```
Hub(config-if)# ipv6 nhrp map multicast dynamic
Hub(config-if)# ipv6 nhrp network-id 100
Hub(config-if)# ipv6 nhrp holdtime 100
Hub(config-if)# tunnel source Ethernet0/1
Hub(config-if)# tunnel mode gre multipoint ipv6

! Configure the physical interface on the hub

Hub(config)# ipv6 unicast-routing
Hub(config)# interface Ethernet0/0
Hub(config-if)# ipv6 address 2001:DB8:1111:2222::1/64
Hub(config-if)# no shutdown
Hub(config-if)# exit
Hub(config)# ipv6 route ::/0 2001:DB8:1111:2222::2

! Configure the tunnel interface on spoke

Spoke1(config)# ipv6 unicast-routing
Spoke1(config)# interface tunnel 1
Spoke1(config-if)# description DMVPN Spoke 1
Spoke1(config-if)# ipv6 address 2001:DB8:1111:4444::2/64
Spoke1(config-if)# ipv6 nhrp map multicast dynamic
Spoke1(config-if)# ipv6 nhrp map 2001:DB8:1111:4444::1/64 2001:DB8:1111:3333::1
Spoke1(config-if)# ipv6 nhrp map multicast 2001:DB8:1111:3333::1
Spoke1(config-if)# ipv6 nhrp network-id 100
Spoke1(config-if)# ipv6 nhrp holdtime 100
Spoke1(config-if)# ipv6 nhrp nhs 2001:DB8:1111:4444::1
Spoke1(config-if)# tunnel source Ethernet0/0
Spoke1(config-if)# tunnel mode gre multipoint ipv6

! Configure the physical interface on the spoke

Spoke1(config)# interface Ethernet0/0
Spoke1(config-if)# ipv6 address 2001:DB8:1111:2222::2/64
Spoke1(config-if)# exit

! Configure the R2 device at the spoke

R2(config)# interface Ethernet0/1
R2(config-if)# ipv6 address 2001:DB8:1111:3333::1/64
R2(config-if)# no shutdown
R2(config-if)# exit
R2(config)# ipv6 route 2001:DB8:1111:1111::/64 2001:DB8:1111:2222::1
```

Additional References

Related Documents

Related Topic	Document Title
IPv6 addressing and connectivity	<i>IPv6 Configuration Guide</i>
Cisco IOS commands	Cisco IOS Master Command List, All Releases
IPv6 commands	Cisco IOS IPv6 Command Reference
Cisco IOS IPv6 features	Cisco IOS IPv6 Feature Mapping

Standards and RFCs

Standard/RFC	Title
RFCs for IPv6	<i>IPv6 RFCs</i>

MIBs

MIB	MIBs Link
	To locate and download MIBs for selected platforms, Cisco IOS releases, and feature sets, use Cisco MIB Locator found at the following URL: http://www.cisco.com/go/mibs

Technical Assistance

Description	Link
The Cisco Support and Documentation website provides online resources to download documentation, software, and tools. Use these resources to install and configure the software and to troubleshoot and resolve technical issues with Cisco products and technologies. Access to most tools on the Cisco Support and Documentation website requires a Cisco.com user ID and password.	http://www.cisco.com/cisco/web/support/index.html

Feature Information for mGRE Tunnel Support over IPv6

The following table provides release information about the feature or features described in this module. This table lists only the software release that introduced support for a given feature in a given software release train. Unless noted otherwise, subsequent releases of that software release train also support that feature.

Use Cisco Feature Navigator to find information about platform support and Cisco software image support. To access Cisco Feature Navigator, go to www.cisco.com/go/cfn. An account on Cisco.com is not required.

Table 1: Feature Information for mGRE Tunnel Support over IPv6

Feature Name	Releases	Feature Information
mGRE Tunnel Support over IPv6	15.2(1)T XE Release 3.8S	mGRE tunnels are configured to enable service providers deploy IPv6 in their core infrastructure.



CHAPTER 3

IP over IPv6 Tunnels

IPv6 supports IP over IPv6 tunnels, which includes the following:

- Generic routing encapsulation (GRE) IPv4 tunnel support for IPv6 traffic—IPv6 traffic can be carried over IPv4 GRE tunnels using the standard GRE tunneling technique that is designed to provide the services to implement any standard point-to-point encapsulation scheme. The primary use of GRE tunnels is for stable connections that require regular secure communication between two edge devices or between an edge device and an end system. The edge devices and the end systems must be dual-stack implementations.
- GRE support over IPv6 transport—GRE has a protocol field that identifies the passenger protocol. GRE tunnels allow Intermediate System-to-Intermediate System (IS-IS) or IPv6 to be specified as a passenger protocol, which allows both IS-IS and IPv6 traffic to run over the same tunnel.
- VRF-aware IPv4/IPv6 over IPv6 tunnels - Virtual Routing and Forwarding (VRF)-aware tunnels are used to connect customer networks separated by untrusted core networks or core networks with different infrastructures (IPv4 or IPv6).
- [Information About IP over IPv6 Tunnels, on page 13](#)
- [How to Configure IP over IPv6 Tunnels , on page 14](#)
- [Configuration Examples for IP over IPv6 Tunnels, on page 15](#)
- [Additional References, on page 20](#)
- [Feature Information for IP over IPv6 Tunnels, on page 21](#)

Information About IP over IPv6 Tunnels

GRE IPv4 Tunnel Support for IPv6 Traffic

IPv6 traffic can be carried over IPv4 GRE tunnels using the standard GRE tunneling technique that is designed to provide the services to implement any standard point-to-point encapsulation scheme. As in IPv6 manually configured tunnels, GRE tunnels are links between two points, with a separate tunnel for each link. The tunnels are not tied to a specific passenger or transport protocol but, in this case, carry IPv6 as the passenger protocol with the GRE as the carrier protocol and IPv4 or IPv6 as the transport protocol.

The primary use of GRE tunnels is for stable connections that require regular secure communication between two edge devices or between an edge device and an end system. The edge devices and the end systems must be dual-stack implementations.

GRE Support over IPv6 Transport

GRE has a protocol field that identifies the passenger protocol. GRE tunnels allow Intermediate System-to-Intermediate System (IS-IS) or IPv6 to be specified as a passenger protocol, which allows both IS-IS and IPv6 traffic to run over the same tunnel. If GRE did not have a protocol field, it would be impossible to distinguish whether the tunnel was carrying IS-IS or IPv6 packets. The GRE protocol field makes it desirable to tunnel IS-IS and IPv6 inside GRE.

How to Configure IP over IPv6 Tunnels

The following tasks describe how to configure an IPv6 tunnel. IPv6 or IPv4 packets can be forwarded on this tunnel.

Configuring GRE IPv6 Tunnels

Perform this task to configure a GRE tunnel on an IPv6 network. GRE tunnels can be configured to run over an IPv6 network layer and transport IPv6 and IPv4 packets through IPv6 tunnels.



Note You must enable IPv6 or configure IPv6 MTU size more than 1500 on a tunnel's exit interface to avoid receiving warning messages.

Before you begin

When GRE IPv6 tunnels are configured, IPv6 addresses are assigned to the tunnel source and the tunnel destination. The tunnel interface can have either IPv4 or IPv6 addresses. The host or device at each end of the configured tunnel must support both IPv4 and IPv6 protocol stacks.

Procedure

	Command or Action	Purpose
Step 1	enable Example: Device> enable	Enables privileged EXEC mode. <ul style="list-style-type: none"> • Enter your password if prompted.
Step 2	configure terminal Example: Device# configure terminal	Enters global configuration mode.
Step 3	interface tunnel <i>tunnel-number</i> Example: Device(config)# interface tunnel 0	Specifies a tunnel interface and number and enters interface configuration mode.
Step 4	tunnel source {<i>ipv6-address</i> <i>interface-type</i> <i>interface-number</i> }	Specifies the source IPv6 address or the source interface type and number for the tunnel interface.

	Command or Action	Purpose
	Example: Device(config-if)# tunnel source ethernet 0	<ul style="list-style-type: none"> If an interface type and number are specified, the interface must be configured with an IPv6 address. Note For more information on the tunnel source command, refer to the IPv6 command reference guide.
Step 5	tunnel destination <i>ipv6-address</i> Example: Device(config-if)# tunnel destination 2001:0DB8:0C18:2::300	Specifies the destination IPv6 address for the tunnel interface. Note For more information on the tunnel destination command, refer to the IPv6 command reference guide.
Step 6	tunnel mode gre ipv6 Example: Device(config-if)# tunnel mode gre ipv6	Specifies a GRE IPv6 tunnel. Note The tunnel mode gre ipv6 command specifies GRE as the encapsulation protocol for the tunnel interface. Only the syntax used in this context is displayed. For more details, see the IPv6 Command Reference .
Step 7	end Example: Device(config-if)# end	Exits interface configuration mode and returns to privileged EXEC mode.

Configuration Examples for IP over IPv6 Tunnels

Example: IPv6 over IPv6 Tunnel

Example: Configuring CE1

```

!
ipv6 unicast-routing
ipv6 cef
!
interface Ethernet0/0
 no ipv6 address
 ipv6 address 2001:DB8:2:1::1/64
 no shutdown
 exit
!

ipv6 route 2001:DB8:2:5::/64 2001:DB8:2:1::2
ipv6 route 2001:DB8:2:9::/64 2001:DB8:2:1::2
!

```

Example: Configuring PE1

```

!
ipv6 unicast-routing
ipv6 cef
!
interface Tunnel0
 no ipv6 address
 ipv6 address 2001:DB8:2:9::1/64
 tunnel source 2001:DB8:2:2::1
 tunnel mode ipv6
 tunnel destination 2001:DB8:2:4::2
 exit
!
interface Ethernet0/0
 no ipv6 address
 ipv6 address 2001:DB8:2:1::2/64
 no shutdown
 exit
!
!
interface Ethernet1/1
 no ipv6 address
 ipv6 address 2001:DB8:2:2::1/64
 no shutdown
 exit
!

ipv6 route 2001:DB8:2:3::/64 2001:DB8:2:2::2
ipv6 route 2001:DB8:2:4::/64 2001:DB8:2:2::2
ipv6 route 2001:DB8:2:5::/64 Tunnel0 2001:DB8:2:9::2

```

Example: Configuring PE2

```

!
ipv6 unicast-routing
ipv6 cef
!
interface Tunnel0
 no ipv6 address
 ipv6 address 2001:DB8:2:9::2/64
 tunnel source 2001:DB8:2:4::2
 tunnel mode ipv6
 tunnel destination 2001:DB8:2:2::1
 exit
!
interface Ethernet0/0
 no ipv6 address
 ipv6 address 2001:DB8:2:5::1/64
 no shutdown
 exit
!
interface Ethernet0/1
 no ipv6 address
 ipv6 address 2001:DB8:2:4::2/64
 no shutdown
 exit

```

```
!  
!  
ipv6 route 2001:DB8:2:2::/64 2001:DB8:2:4::1  
ipv6 route 2001:DB8:2:3::/64 2001:DB8:2:4::1  
ipv6 route 2001:DB8:2:1::/64 Tunnel0 2001:DB8:2:9::1
```

Example: Configuring CE2

```
!  
ipv6 unicast-routing  
ipv6 cef  
!  
interface Ethernet0/0  
no ipv6 address  
ipv6 address 2001:DB8:2:5::2/64  
no shutdown  
exit  
!  
ipv6 route 2001:DB8:2:1::/64 2001:DB8:2:5::1  
ipv6 route 2001:DB8:2:9::/64 2001:DB8:2:5::1  
!
```

Example: Configuring Core Device 1

```
!  
ipv6 unicast-routing  
ipv6 cef  
!  
interface Ethernet1/0  
no ipv6 address  
no shutdown  
ipv6 address 2001:DB8:2:3::1/64  
exit  
!  
interface Ethernet1/1  
no ipv6 address  
ipv6 address 2001:DB8:2:2::2/64  
no shutdown  
exit  
!  
ipv6 route 2001:DB8:2:4::/64 2001:DB8:2:3::2
```

Example: Configuring Core Device 2

```
!  
ipv6 unicast-routing  
ipv6 cef  
!  
interface Ethernet0/1  
no ip address  
ipv6 address 2001:DB8:2:4::1/64  
no shutdown
```

```

exit
!
interface Ethernet1/0
no ip address
ipv6 address 2001:DB8:2:3::2/64
no shutdown
exit
!
ipv6 route 2001:DB8:2:2::/64 2001:DB8:2:3::1

```

Example: IPv4 over IPv6 Tunnel

Example: Configuring CE1

```

!
ipv6 unicast-routing
ipv6 cef
!
interface Ethernet0/0
no ip address
ip address 192.168.1.1 255.255.255.0
no shutdown
exit
!
ip route 192.168.5.0 255.255.255.0 192.168.1.2
ip route 192.168.9.0 255.255.255.0 192.168.1.2
!

```

Example: Configuring PE1

```

!
ipv6 unicast-routing
ipv6 cef
!
interface Tunnel0
no ip address
ip address 192.168.9.1 255.255.255.0
tunnel source 2001:DB8:2:2::1
tunnel destination 2001:DB8:2:4::2
tunnel mode ipv6
exit
!
interface Ethernet0/0
no ip address
ip address 192.168.1.2 255.255.255.0
no shutdown
exit
!
!
interface Ethernet1/1
no ipv6 address
ipv6 address 2001:DB8:2:2::1/64
no shutdown
exit

```



```

!
ipv6 route 2001:DB8:2:3::/64 2001:DB8:2:2::2
ipv6 route 2001:DB8:2:4::/64 2001:DB8:2:2::2
ip route 192.168.5.0 255.255.255.0 Tunnel 0 192.168.9.2

```

Example: Configuring PE2

```

!
ipv6 unicast-routing
ipv6 cef
!
interface Tunnel0
 no ip address
 ip address 192.168.9.2 255.255.255.0
 tunnel source 2001:DB8:2:4::2
 tunnel destination 2001:DB8:2:2::1
 tunnel mode ipv6
 exit
!
interface Ethernet0/0
 no ip address
 ip address 192.168.5.1 255.255.255.0
 no shutdown
 exit
!
interface Ethernet0/1
 no ipv6 address
 ipv6 address 2001:DB8:2:4::2/64
 no shutdown
 exit
!
!
ipv6 route 2001:DB8:2:2::/64 2001:DB8:2:4::1
ipv6 route 2001:DB8:2:3::/64 2001:DB8:2:4::1
ip route 192.168.1.0 255.255.255.0 Tunnel 0 192.168.9.1

```

Example: Configuring CE2

```

!
ipv6 unicast-routing
ipv6 cef
!
interface Ethernet0/0
 no ip address
 ip address 192.168.5.2 255.255.255.0
 no shutdown
 exit
!
ip route 192.168.1.0 255.255.255.0 192.168.1.2
ip route 192.168.9.0 255.255.255.0 192.168.1.2
!

```

Example: Configuring Core Device 1

```

!
ipv6 unicast-routing
ipv6 cef
!
interface Ethernet1/0
 no ipv6 address
 no shutdown
 ipv6 address 2001:DB8:2:3::1/64
 exit
!
interface Ethernet1/1
 no ipv6 address
 ipv6 address 2001:DB8:2:2::2/64
 no shutdown
 exit
!
ipv6 route 2001:DB8:2:4::/64 2001:DB8:2:3::2

```

Example: Configuring Core Device 2

```

!
ipv6 unicast-routing
ipv6 cef
!
interface Ethernet0/1
 no ip address
 ipv6 address 2001:DB8:2:4::1/64
 no shutdown
 exit
!
interface Ethernet1/0
 no ip address
 ipv6 address 2001:DB8:2:3::2/64
 no shutdown
 exit
!
ipv6 route 2001:DB8:2:2::/64 2001:DB8:2:3::1

```

Additional References

Related Documents

Related Topic	Document Title
Cisco IOS commands	Cisco IOS Master Command List, All Releases

Related Topic	Document Title
IPv6 commands	Cisco IOS IPv6 Command Reference
IPv6 addressing and connectivity	<i>IPv6 Configuration Guide</i>
Cisco IOS IPv6 features	Cisco IOS IPv6 Feature Mapping

Standards and RFCs

Standard/RFC	Title
RFCs for IPv6	<i>IPv6 RFC</i>

Technical Assistance

Description	Link
The Cisco Support and Documentation website provides online resources to download documentation, software, and tools. Use these resources to install and configure the software and to troubleshoot and resolve technical issues with Cisco products and technologies. Access to most tools on the Cisco Support and Documentation website requires a Cisco.com user ID and password.	http://www.cisco.com/cisco/web/support/index.html

Feature Information for IP over IPv6 Tunnels

The following table provides release information about the feature or features described in this module. This table lists only the software release that introduced support for a given feature in a given software release train. Unless noted otherwise, subsequent releases of that software release train also support that feature.

Use Cisco Feature Navigator to find information about platform support and Cisco software image support. To access Cisco Feature Navigator, go to www.cisco.com/go/cfn. An account on Cisco.com is not required.

Table 2: Feature Information for IP over IPv6 Tunnels

Feature Name	Releases	Feature Information
IP over IPv6 Tunnels	12.2(30)S 12.2(33)SRA 12.3(7)T 12.4 12.4(2)T 15.0(1)S Cisco IOS XE Release 2.1 15.1(1)SY	IP over IPv6 Tunnels feature is supported. The following commands were introduced or modified: tunnel destination , tunnel mode ipv6 , tunnel mode gre ipv6 , tunnel source .



CHAPTER 4

Manually Configured IPv6 over IPv4 Tunnels

This feature provides support for manually configured IPv6 over IPv4 tunnels. A manually configured tunnel is equivalent to a permanent link between two IPv6 domains over an IPv4 backbone.

- [Finding Feature Information, on page 23](#)
- [Information About Manually Configured IPv6 over IPv4 Tunnels, on page 23](#)
- [How to Enable Manually Configured IPv6 over IPv4 Tunnels, on page 26](#)
- [Configuration Examples for Manually Configured IPv6 over IPv4 Tunnels, on page 27](#)
- [Additional References, on page 31](#)
- [Feature Information for Manually Configured IPv6 over IPv4 Tunnels, on page 32](#)

Finding Feature Information

Your software release may not support all the features documented in this module. For the latest caveats and feature information, see [Bug Search Tool](#) and the release notes for your platform and software release. To find information about the features documented in this module, and to see a list of the releases in which each feature is supported, see the feature information table.

Use Cisco Feature Navigator to find information about platform support and Cisco software image support. To access Cisco Feature Navigator, go to www.cisco.com/go/cfn. An account on Cisco.com is not required.

Information About Manually Configured IPv6 over IPv4 Tunnels

Overlay Tunnels for IPv6

Overlay tunneling encapsulates IPv6 packets in IPv4 packets for delivery across an IPv4 infrastructure (a core network or the figure below). By using overlay tunnels, you can communicate with isolated IPv6 networks without upgrading the IPv4 infrastructure between them. Overlay tunnels can be configured between border devices or between a border device and a host; however, both tunnel endpoints must support both the IPv4 and IPv6 protocol stacks. IPv6 supports the following types of overlay tunneling mechanisms:

- Manual
- Generic routing encapsulation (GRE)
- IPv4-compatible

- 6to4
- Intrasite Automatic Tunnel Addressing Protocol (ISATAP)

Figure 1: Overlay Tunnels

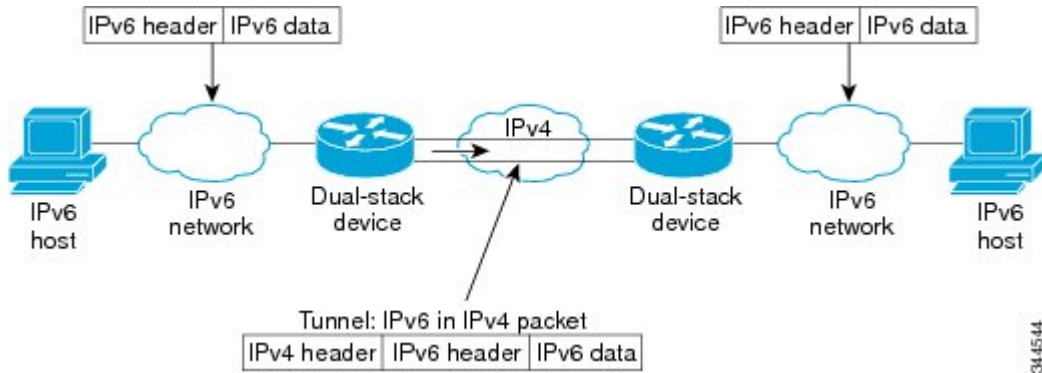
**Note**

Overlay tunnels reduce the maximum transmission unit (MTU) of an interface by 20 octets (assuming that the basic IPv4 packet header does not contain optional fields). A network that uses overlay tunnels is difficult to troubleshoot. Therefore, overlay tunnels that connect isolated IPv6 networks should not be considered a final IPv6 network architecture. The use of overlay tunnels should be considered as a transition technique toward a network that supports both the IPv4 and IPv6 protocol stacks or just the IPv6 protocol stack.

Use the table below to help you determine which type of tunnel that you want to configure to carry IPv6 packets over an IPv4 network.

Table 3: Suggested Usage of Tunnel Types to Carry IPv6 Packets over an IPv4 Network

Tunneling Type	Suggested Usage	Usage Notes
Manual	Simple point-to-point tunnels that can be used within a site or between sites.	Can carry IPv6 packets only.
GRE- and IPv4-compatible	Simple point-to-point tunnels that can be used within a site or between sites.	Can carry IPv6, Connectionless Network Service (CLNS), and many other types of packets.
IPv4-compatible	Point-to-multipoint tunnels.	Uses the <code>::/96</code> prefix. We do not recommend using this tunnel type.
6to4	Point-to-multipoint tunnels that can be used to connect isolated IPv6 sites.	Sites use addresses from the <code>2002::/16</code> prefix.
6RD	IPv6 service is provided to customers over an IPv4 network by using encapsulation of IPv6 in IPv4.	Prefixes can be from the SP's own address block.
ISATAP	Point-to-multipoint tunnels that can be used to connect systems within a site.	Sites can use any IPv6 unicast addresses.

Individual tunnel types are discussed in detail in this document. We recommend that you review and understand the information about the specific tunnel type that you want to implement. When you are familiar with the type of tunnel you need, see the table below for a summary of the tunnel configuration parameters that you may find useful.

Table 4: Tunnel Configuration Parameters by Tunneling Type

Tunneling Type	Tunnel Configuration Parameter			
Tunnel Mode	Tunnel Source	Tunnel Destination	Interface Prefix or Address	
Manual	ipv6ip	An IPv4 address, or a reference to an interface on which IPv4 is configured.	An IPv4 address.	An IPv6 address.
GRE/IPv4	gre ip		An IPv4 address.	An IPv6 address.
IPv4- compatible	ipv6ip auto-tunnel		Not required. These are all point-to-multipoint tunneling types. The IPv4 destination address is calculated, on a per-packet basis, from the IPv6 destination.	Not required. The interface address is generated as <code>::tunnel-source/96</code> .
6to4	ipv6ip 6to4		An IPv6 address. The prefix must embed the tunnel source IPv4 address.	
6RD	ipv6ip 6rd		An IPv6 address.	
ISATAP	ipv6ip isatap		An IPv6 prefix in modified eui-64 format. The IPv6 address is generated from the prefix and the tunnel source IPv4 address.	

IPv6 Manually Configured Tunnels

A manually configured tunnel is equivalent to a permanent link between two IPv6 domains over an IPv4 backbone. The primary use is for stable connections that require regular secure communication between two edge devices or between an end system and an edge device, or for connection to remote IPv6 networks.

An IPv6 address is manually configured on a tunnel interface, and manually configured IPv4 addresses are assigned to the tunnel source and the tunnel destination. The host or device at each end of a configured tunnel must support both the IPv4 and IPv6 protocol stacks. Manually configured tunnels can be configured between border devices or between a border device and a host. Cisco Express Forwarding switching can be used for IPv6 manually configured tunnels, or Cisco Express Forwarding switching can be disabled if process switching is needed.

How to Enable Manually Configured IPv6 over IPv4 Tunnels

Configuring Manual IPv6 Tunnels

Before you begin

With manually configured IPv6 tunnels, an IPv6 address is configured on a tunnel interface, and manually configured IPv4 addresses are assigned to the tunnel source and the tunnel destination. The host or device at each end of a configured tunnel must support both the IPv4 and IPv6 protocol stacks.

SUMMARY STEPS

1. **enable**
2. **configure terminal**
3. **interface tunnel *tunnel-number***
4. Enter one of the following commands:
 - **ipv6 address** {*ipv6-address/prefix-length* | *prefix-name sub-bits/prefix-length*}
 - **ipv6 address** *ipv6-prefix/prefix-length* [**eui-64**]
5. **tunnel source** {*ip-address* | *interface-type interface-number*}
6. **tunnel destination** *ip-address*
7. **tunnel mode ipv6ip**
8. **end**

DETAILED STEPS

	Command or Action	Purpose
Step 1	enable Example: Device> enable	Enables privileged EXEC mode. <ul style="list-style-type: none"> • Enter your password if prompted.
Step 2	configure terminal Example: Device# configure terminal	Enters global configuration mode.
Step 3	interface tunnel <i>tunnel-number</i> Example: Device(config)# interface tunnel 0	Specifies a tunnel interface and number, and enters interface configuration mode.
Step 4	Enter one of the following commands: <ul style="list-style-type: none"> • ipv6 address {<i>ipv6-address/prefix-length</i> <i>prefix-name sub-bits/prefix-length</i>} 	Specifies the IPv6 network assigned to the interface and enables IPv6 processing on the interface. <ul style="list-style-type: none"> • If you specify the eui-64 keyword, the software configures an IPv6 address for an interface and enables

	Command or Action	Purpose
	<ul style="list-style-type: none"> • ipv6 address <i>ipv6-prefix/prefix-length</i> [eui-64] <p>Example:</p> <pre>Device(config-if)# ipv6 address 3ffe:b00:c18:1::3/127</pre>	<p>IPv6 processing on the interface using an EUI-64 interface ID in the low-order 64 bits of the address.</p> <p>Note See the “Implementing IPv6 Addressing and Basic Connectivity” module for more information on configuring IPv6 addresses.</p>
Step 5	<p>tunnel source {<i>ip-address</i> <i>interface-type interface-number</i>}</p> <p>Example:</p> <pre>Device(config-if)# tunnel source gigabitethernet 0/0/0</pre>	<p>Specifies the source IPv4 address or the source interface type and number for the tunnel interface.</p> <ul style="list-style-type: none"> • If an interface is specified, the interface must be configured with an IPv4 address.
Step 6	<p>tunnel destination <i>ip-address</i></p> <p>Example:</p> <pre>Device(config-if)# tunnel destination 192.168.30.1</pre>	<p>Specifies the destination IPv4 address or hostname for the tunnel interface.</p>
Step 7	<p>tunnel mode ipv6ip</p> <p>Example:</p> <pre>Device(config-if)# tunnel mode ipv6ip</pre>	<p>Specifies a manual IPv6 tunnel.</p> <p>Note The tunnel mode ipv6ip command specifies IPv6 as the passenger protocol and IPv4 as both the encapsulation and transport protocol for the manual IPv6 tunnel.</p>
Step 8	<p>end</p> <p>Example:</p> <pre>Device(config-if)# end</pre>	<p>Returns to privileged EXEC mode.</p>

Configuration Examples for Manually Configured IPv6 over IPv4 Tunnels

Example: Configuring Manual IPv6 Tunnels

The following example configures a manual IPv6 tunnel between router A and router B. In the example, tunnel interface 0 for both router A and router B is manually configured with a global IPv6 address. The tunnel source and destination addresses are also manually configured.

Router A Configuration

```
interface ethernet 0
 ip address 192.168.99.1 255.255.255.0
 interface tunnel 0
```

Example: IPv6 over GRE IPv4 Tunnel

```

ipv6 address 3ffe:b00:c18:1::3/127
tunnel source ethernet 0
tunnel destination 192.168.30.1
tunnel mode ipv6ip

```

Router B Configuration

```

interface ethernet 0
ip address 192.168.30.1 255.255.255.0
interface tunnel 0
ipv6 address 3ffe:b00:c18:1::2/127
tunnel source ethernet 0
tunnel destination 192.168.99.1
tunnel mode ipv6ip

```

Example: IPv6 over GRE IPv4 Tunnel

Example: Configuring CE1

```

!
ipv6 unicast-routing
ipv6 cef
!
interface Ethernet0/0
no ip address
ipv6 address 2001:DB8:2:1::1/64
no shutdown
exit
!
!
ipv6 route 2001:DB8:2:2::/64 2001:DB8:2:1::2
ipv6 route 2001:DB8:2:4::/64 2001:DB8:2:1::2
!

```

Example: Configuring PE1

```

ipv6 unicast-routing
ipv6 cef
!
interface Tunnel0
no ip address
ipv6 address 2001:DB8:2:4::1/64
tunnel source 10.22.22.22
tunnel destination 10.44.44.44
exit
!
interface Ethernet0/0
no ip address
ipv6 address 2001:DB8:2:1::2/64
no shutdown
exit
!
interface Ethernet1/1
no ip address
ip address 10.22.22.22 255.255.255.0
no shutdown

```

```
exit
!  
ip route 10.44.44.0 255.255.255.0 10.22.22.23  
ipv6 route 2001:DB8:2:2::/64 Tunnel0 2001:DB8:2:4::2
```

Example: Configuring PE2

```
!  
ipv6 unicast-routing  
ipv6 cef  
!  
interface Tunnel0  
no ipv6 address  
ipv6 address 2001:DB8:2:4::2/64  
tunnel source 10.44.44.44  
tunnel destination 10.22.22.22  
exit  
!  
interface Ethernet0/0 no ipv6 address  
ipv6 address 2001:DB8:2:2::1/64  
no shutdown  
exit  
!  
interface Ethernet1/0  
no ip address  
ip address 10.44.44.44 255.255.255.0  
no shutdown  
exit  
!  
ip route 10.22.22.0 255.255.255.0 10.44.44.43  
!  
ipv6 route 2001:DB8:2:1::/64 Tunnel0 2001:DB8:2:4::1  
!
```

Example: Configuring CE2

```
!  
ipv6 unicast-routing  
ipv6 cef  
!  
!  
interface Ethernet0/0  
no ipv6 address  
ipv6 address 2001:DB8:2:2::2/64  
no shutdown  
exit  
!  
!  
ipv6 route 2001:DB8:2:1::/64 2001:DB8:2:2::1  
ipv6 route 2001:DB8:2:4::/64 2001:DB8:2:2::1  
!
```

Example: Configuring Device X

```

!
interface Ethernet1/0
  no ip address
  ip address 10.44.44.43 255.255.255.0
  no shutdown
  exit
!
interface Ethernet1/1
  no ip address
  ip address 10.22.22.23 255.255.255.0
  no shutdown
  exit
!

```

Example: Verifying the Tunnel Configuration**From CE1**

```

Device# ping ipv6 2001:db8:2:2::2

Type escape sequence to abort.
Sending 5, 100-byte ICMP Echos to 2001:DB8:2:2::2, timeout is 2 seconds:
!!!!
Success rate is 100 percent (5/5), round-trip min/avg/max = 1/9/43 ms

Device# ping ipv6 2001:db8:2:2::2 source 2001:db8:2:1::1

Type escape sequence to abort.
Sending 5, 100-byte ICMP Echos to 2001:DB8:2:2::2, timeout is 2 seconds:
Packet sent with a source address of 2001:DB8:2:1::1
!!!!
Success rate is 100 percent (5/5), round-trip min/avg/max = 1/1/1 ms

```

From PE1

```

Device# show tunnel interface

Tunnel0
  Mode:GRE/IP, Destination 10.44.44.44, Source 10.22.22.22
  IP transport: output interface Ethernet1/1 next hop 10.22.22.23
  Application ID 1: unspecified
  Linestate - current up
  Internal linestate - current up, evaluated up
  Tunnel Source Flags: Local
  Transport IPv4 Header DF bit cleared
  OCE: IP tunnel decap
  Provider: interface Tu0, prot 47
    Performs protocol check [47]
    Protocol Handler: GRE: opt 0x0
      ptype: ipv4 [ipv4 dispatcher: punt]
      ptype: ipv6 [ipv6 dispatcher: from if Tu0]
      ptype: mpls [mpls dispatcher: drop]
      ptype: otv [mpls dispatcher: drop]
      ptype: generic [mpls dispatcher: drop]
  There are 0 tunnels running over the EON IP protocol

```

```

There are 0 tunnels running over the IPinIP protocol
There are 0 tunnels running over the NOSIP protocol
There are 0 tunnels running over the IPv6inIP protocol
There are 0 tunnels running over the RBSCP/IP protocol

```

```
Device# show ip route 10.44.44.44
```

```

Routing entry for 10.44.44.0/24
  Known via "static", distance 1, metric 0
  Routing Descriptor Blocks:
    * 10.22.22.23
      Route metric is 0, traffic share count is 1

```

```
Device# debug ipv6 icmp
```

```

ICMP Packet debugging is on
*Jan 1 10:57:37.882: ICMPv6: Sent R-Advert, Src=FE80::A8BB:CCFF:FE00:5200, Dst=FF02::1
*Jan 1 11:00:18.634: ICMPv6: Received R-Advert, Src=FE80::A8BB:CCFF:FE00:5200,Dst=FF02::1

```

Additional References

Related Documents

Related Topic	Document Title
IPv6 addressing and connectivity	<i>IPv6 Configuration Guide</i>
Cisco IOS commands	Cisco IOS Master Commands List, All Releases
IPv6 commands	Cisco IOS IPv6 Command Reference
Cisco IOS IPv6 features	Cisco IOS IPv6 Feature Mapping

Standards and RFCs

Standard/RFC	Title
RFCs for IPv6	<i>IPv6 RFCs</i>

MIBs

MIB	MIBs Link
	To locate and download MIBs for selected platforms, Cisco IOS releases, and feature sets, use Cisco MIB Locator found at the following URL: <i>http://www.cisco.com/go/mibs</i>

Technical Assistance

Description	Link
The Cisco Support and Documentation website provides online resources to download documentation, software, and tools. Use these resources to install and configure the software and to troubleshoot and resolve technical issues with Cisco products and technologies. Access to most tools on the Cisco Support and Documentation website requires a Cisco.com user ID and password.	http://www.cisco.com/cisco/web/support/index.html

Feature Information for Manually Configured IPv6 over IPv4 Tunnels

The following table provides release information about the feature or features described in this module. This table lists only the software release that introduced support for a given feature in a given software release train. Unless noted otherwise, subsequent releases of that software release train also support that feature.

Use Cisco Feature Navigator to find information about platform support and Cisco software image support. To access Cisco Feature Navigator, go to www.cisco.com/go/cfn. An account on Cisco.com is not required.

Table 5: Feature Information for Manually Configured IPv6 over IPv4 Tunnels

Feature Name	Releases	Feature Information
IPv6 Tunneling: Manually Configured IPv6 over IPv4 Tunnels	Cisco IOS XE Release 2.1	A manually configured tunnel is equivalent to a permanent link between two IPv6 domains over an IPv4 backbone. The following commands were introduced or modified: tunnel destination , tunnel ipv6ip , tunnel source .



CHAPTER 5

Configuring Physical Interfaces

The Cisco ASR 1000 Series Aggregation Services Routers support many different types of physical (hardware) interfaces such as Gigabit Ethernet, Packet over SONET (POS), and serial shared port adapter (SPA) interfaces. For hardware technical descriptions and information about installing interfaces, refer to the hardware installation and configuration publication for your product.

- [Finding Feature Information, on page 33](#)
- [Configuration Information, on page 33](#)
- [Command Reference Information, on page 34](#)

Finding Feature Information

Your software release may not support all the features documented in this module. For the latest caveats and feature information, see [Bug Search Tool](#) and the release notes for your platform and software release. To find information about the features documented in this module, and to see a list of the releases in which each feature is supported, see the feature information table.

Use Cisco Feature Navigator to find information about platform support and Cisco software image support. To access Cisco Feature Navigator, go to www.cisco.com/go/cfn. An account on Cisco.com is not required.

Configuration Information

- For information about using the Gigabit Ethernet Management Ethernet interface, see the "Using the Management Ethernet Interface" chapter of the *Cisco ASR 1000 Series Aggregation Services Routers Software Configuration Guide* at:

<http://www.cisco.com/en/US/docs/routers/asr1000/configuration/guide/chassis/asrswcfg.html>

- For information about configuring and troubleshooting SPA interface processors (SIPs) and SPAs that are supported on a Cisco ASR 1000 Series Aggregation Services Router, see the *Cisco ASR 1000 Series Aggregation Services Routers SIP and SPA Software Configuration Guide* at:

http://cisco.com/en/US/docs/interfaces_modules/shared_port_adapters/configuration/ASR1000/ASRspasw.html

Command Reference Information

- Complete descriptions of the commands used to configure interfaces are included in the *Cisco IOS Interface and Hardware Component Command Reference* at:

http://www.cisco.com/en/US/docs/ios/interface/command/reference/ir_book.html

- For information about other Cisco IOS XE commands, use the Command Lookup Tool at <http://tools.cisco.com/Support/CLILookup> or the *Cisco IOS Master Command List, All Releases*, at http://www.cisco.com/en/US/docs/ios/mcl/allreleasemcl/all_book.html.



CHAPTER 6

Configuring Virtual Interfaces

Virtual interfaces are software-based interfaces that you create in the memory of the networking device using Cisco IOS XE commands. Virtual interfaces do not have a hardware component such as the RJ-45 female port on a 100BASE-T Fast Ethernet network interface card. This module describes the four common types of virtual, or logical, interfaces that can be configured using Cisco IOS XE software:

- Loopback interfaces
- Null interfaces
- Subinterfaces
- Tunnel interfaces
- [Finding Feature Information, on page 35](#)
- [Prerequisites for Configuring Virtual Interfaces, on page 35](#)
- [Information About Configuring Virtual Interfaces, on page 36](#)
- [How to Configure Virtual Interfaces, on page 40](#)
- [Configuration Examples for Virtual Interfaces, on page 48](#)
- [Where to Go Next, on page 49](#)
- [Additional References, on page 49](#)

Finding Feature Information

Your software release may not support all the features documented in this module. For the latest caveats and feature information, see [Bug Search Tool](#) and the release notes for your platform and software release. To find information about the features documented in this module, and to see a list of the releases in which each feature is supported, see the feature information table.

Use Cisco Feature Navigator to find information about platform support and Cisco software image support. To access Cisco Feature Navigator, go to www.cisco.com/go/cfn. An account on Cisco.com is not required.

Prerequisites for Configuring Virtual Interfaces

Before virtual interfaces can be used in your network, you must have some physical (hardware) interfaces configured and you must be able to communicate between the networking devices on which you wish to use virtual interfaces.

Information About Configuring Virtual Interfaces

Virtual Interfaces

Virtual interfaces are network interfaces that are not associated with a physical interface. Physical interfaces have some form of physical element--for example, an RJ-45 male connector on an Ethernet cable. Virtual interfaces exist only in software; there are no physical elements. You identify an individual virtual interface using a numerical ID after the virtual interface name. For example: loopback 0, tunnel 1, and fastethernet 0/0/0.1. The ID is unique per virtual interface type to make the entire name string unique; for example both a loopback 0 interface and a null 0 interface can exist, but two loopback 0 interfaces cannot exist in a single networking device.

Cisco IOS XE software supports four types of virtual interfaces:

- Loopback
- Null
- Subinterface
- Tunnel

Benefits of Virtual Interfaces

A loopback interface can provide a stable interface on which you can assign a Layer 3 address such as an IP or IPX address. This address can be configured as the source address when the networking device needs to send data for protocols such as NetFlow or Cisco Discovery Protocol (CDP) to another device in your network and you want the receiving device to always see the same source IP address from the networking device. This is an issue in networks with multiple equal-cost paths because under normal circumstances the packets that are generated by a networking device use the IP address from the outbound interface as the source address for the packets and because in a network with two or more equal-cost paths from the networking device to the receiving host each packet might use a different outbound interface.

A null interface provides an alternative method of filtering without the overhead involved with using access lists. For example, instead of creating an outbound access list that prevents traffic to a destination network from being transmitted out an interface, you can configure a static route for the destination network that points to the null interface.

Subinterfaces were invented as a method of virtually subdividing a physical interface into two or more interfaces so that the IP routing protocols would see the network connection to each remote networking device as a separate physical interface even though the subinterfaces share a common physical interface. One of the first uses of subinterfaces was to resolve the problem with split horizon on Frame Relay WANs.

The following are several situations in which tunneling (encapsulating traffic in another protocol) is useful:

- To enable multiprotocol local networks over a single-protocol backbone
- To provide workarounds for networks that use protocols that have limited hop counts; for example, RIP version 1, AppleTalk
- To connect discontinuous subnetworks
- To allow virtual private networks across WANs

Loopback Interfaces

You can specify a software-only interface called a loopback interface to emulate a physical interface. Loopback interfaces are supported on all platforms. A loopback interface is a virtual interface on a Cisco router that remains up (active) after you issue the **no shutdown** command until you disable it with the **shutdown** command. Unlike subinterfaces, loopback interfaces are independent of the state of any physical interface.

The loopback interface can be considered stable because once you enable it, it will remain up until you shut it down. This makes loopback interfaces ideal for assigning Layer 3 addresses such as IP addresses when you want a single address as a reference that is independent of the status of any physical interfaces in the networking device. A good example of this is using the IP address of a loopback interface as the IP address for the domain name system (DNS) host address for the networking device. Before loopback interfaces were available, network administrators had to configure a DNS host entry for every interface on a router that had an IP address assigned to it because they could never be certain which interface IP address might be available at any given time for managing the router. In the sample interface configuration and DNS entries for Router A shown below, you can see that there is a DNS entry for each interface.

Router A Interface Configuration Before Loopback

```
GigabitEthernet0 10.10.10.1 255.255.255.0
GigabitEthernet1 10.10.11.1 255.255.255.0
GigabitEthernet2 10.10.12.1 255.255.255.0
GigabitEthernet3 10.10.13.1 255.255.255.0
GigabitEthernet4 10.10.14.1 255.255.255.0
GigabitEthernet5 10.10.15.1 255.255.255.0
```

Router A DNS Entries Before Loopback

```
RouterA      IN  A  10.10.10.1
             IN  A  10.10.11.1
             IN  A  10.10.12.1
             IN  A  10.10.13.1
             IN  A  10.10.14.1
             IN  A  10.10.15.1
```

Interfaces on networking devices can fail, and they can also be taken out of service for maintenance. If any of the interfaces in Router A fails or is taken out of service, another networking device will not be able to access that interface. When you configure a networking device with a loopback interface and assign it an IP address that is advertised throughout the network, the networking device will be reachable by using this IP address as long as the networking device has at least one network interface capable of sending and receiving IP traffic. In the sample interface configuration and DNS entries for Router A after a loopback interface is configured, you can see that there is now only one DNS entry that can be used to reach the router over any of its physical interfaces.

Router A Interface Configuration After Loopback

```
Loopback 172.16.78.1 255.255.255.0
GigabitEthernet0 10.10.10.1 255.255.255.0
GigabitEthernet1 10.10.11.1 255.255.255.0
GigabitEthernet2 10.10.12.1 255.255.255.0
GigabitEthernet3 10.10.13.1 255.255.255.0
GigabitEthernet4 10.10.14.1 255.255.255.0
GigabitEthernet5 10.10.15.1 255.255.255.0
```

Router A DNS Entries After Loopback

```
RouterA IN A 172.16.78.1
```

The configured IP address of the loopback interface--172.16.78.1--can be used as the source address for packets generated by the router and forwarded to networking management applications and routing protocols. Unless this loopback interface is explicitly shut down, it is always reachable.

You can use the loopback interface as the termination address for open shortest path first (OSPF) or border gateway protocol (BGP) sessions. A loopback interface can also be used to establish a Telnet session from the console port of the device to its auxiliary port when all other interfaces are down. In applications where other routers or access servers attempt to reach this loopback interface, you should configure a routing protocol to distribute the subnet assigned to the loopback address.

IP Packets routed to the loopback interface are rerouted back to the router or access server and processed locally. IP packets routed out the loopback interface but not destined to the loopback interface are dropped. Under these two conditions, the loopback interface can behave like a null interface.

Loopback Interfaces Versus Loopback Mode

Loopback interfaces provide a stable source interface to ensure that the IP address assigned to the interface is always reachable as long as the IP routing protocols continue to advertise the subnet assigned to the loopback interface. Loopback mode, however, is used to test and diagnose issues with WAN (serial) links such as bit loss or data corruption. The idea is to configure a loop to return the data packets that were received by the interface back out the same interface to the device that originated the traffic. Loopback mode is used to troubleshoot problems by checking that the data packets are returned in the same condition in which they were sent. Errors in the data packets indicate a problem with the WAN infrastructure. Many types of serial interfaces have their own form of loopback command syntax that is entered under interface or controller configuration mode.

Null Interfaces

The null interface is a virtual network interface that is similar to the loopback interface. Whereas traffic to the loopback interface is directed to the router itself, traffic sent to the null interface is discarded. This interface is always up and can never forward or receive traffic; encapsulation always fails. The null interface functions similarly to the null devices available on most operating systems.

Null interfaces are used as a low-overhead method of discarding unnecessary network traffic. For example, if you do not want your network users to be able to reach certain IP subnets, you can create static IP routes for the subnets that point to the null interface of a networking device. Using the static IP routes takes less CPU time for the networking device than using IP access lists. The static-route configuration is also easier to configure than IP access lists because it is done in global configuration mode instead of in interface configuration mode.

The null interface may not be configured with an address. Traffic can be sent to this interface only by configuring a static route where the next hop is the null interface--represented by Null 0. One example of configuring the next hop to be the null interface is to create a route to an aggregate network that can then be announced through the BGP, or to ensure that traffic to a particular range of addresses is not propagated through the router, perhaps for security purposes.

The router always has a single null interface. By default, a packet sent to the null interface causes the router to respond by sending an Internet Control Message Protocol (ICMP) unreachable message to the source IP

address of the packet. You can configure the router either to send these responses or to drop the packets silently.

Subinterfaces

Subinterfaces are associated with physical interfaces. Subinterfaces are enabled when the physical interface with which they are associated is enabled, and subinterfaces are disabled when the physical interface is shut down.



Note Subinterfaces can be enabled and shut down independently of the physical port with which they are associated. However, you cannot enable a subinterface of a physical interface that has been shut down.

Subinterfaces are created by subdividing the physical interface into two or more virtual interfaces on which you can assign unique Layer 3 network addresses such as IP subnets. One of the first uses of subinterfaces was to resolve the problem with split horizon on Frame Relay WANs. Split horizon is a behavior associated with IP routing protocols such as RIP in which IP subnets are not advertised back out the same physical interface that they were learned over. Split horizon was implemented to prevent routing loops in IP networks. A routing loop can be created when the networking devices at both ends of a network connection advertise the same IP routes to each other. Split horizon was an issue for Frame Relay multipoint network interfaces--interfaces that connect to two or more remote networking devices over a single physical interface--because the default behavior of many networking devices was to implement split horizon, which means that the networking device did not advertise the IP routes that were learned over an interface back out the interface to other devices that were also reachable via the same physical interface. Subinterfaces were invented as a method of virtually subdividing a physical interface into two or more interfaces so that the IP routing protocols would see the network connection to each remote networking device as a separate physical interface even though the subinterfaces share a common physical interface. Although TCP/IP now disables split horizon limitations by default, protocols such as AppleTalk and IPX are still constrained by split horizon.

Subinterfaces are identified by a prefix that consists of the hardware interface descriptor (IDB) followed by a period and then by a number that is unique for that prefix. The full subinterface number must be unique to the networking device. For example, the first subinterface for GigabitEthernet interface 0/0/0 might be named GigabitEthernet 0/0/0.1 where .1 indicates the subinterface.

Tunnel Interfaces

Tunneling provides a way to encapsulate arbitrary packets inside a transport protocol. Tunnels are implemented as a virtual interface to provide a simple interface for configuration. The tunnel interface is not tied to specific "passenger" or "transport" protocols, but, rather, it is an architecture that is designed to provide the services necessary to implement any standard point-to-point encapsulation scheme.

There are several ways to implement tunnel interfaces depending on the connectivity that you need to provide. One common use for tunnels is to carry data traffic for a network protocol such as IPX over devices in your network that do not support IPX. For instance, if your network uses IPX in sites at the edge of your network but not in the core of your network, you can connect the IPX sites at the network edges by tunneling IPX in IP over the core of the network.

For more details about the various types of tunneling techniques available using Cisco IOS XE software, see the "Implementing Tunnels" module of the *Cisco IOS XE Interface and Hardware Component Configuration Guide*.

How to Configure Virtual Interfaces

Configuring a Loopback Interface

This task explains how to configure a loopback interface. A loopback interface can be considered stable because once you enable it, it will remain up until you shut it down. This makes loopback interfaces ideal for assigning Layer 3 addresses such as IP addresses when you want to have a single address to use as a reference that is independent of the status of any of the physical interfaces in the networking device.

Before you begin

The IP address for the loopback interface must be unique and not in use by another interface.

SUMMARY STEPS

1. **enable**
2. **configure terminal**
3. **interface loopback** *number*
4. **ip address** *ip-address mask* [**secondary**]
5. **end**
6. **show interfaces loopback** *number*
7. **exit**

DETAILED STEPS

	Command or Action	Purpose
Step 1	enable Example: Router> enable	Enables privileged EXEC mode. <ul style="list-style-type: none"> • Enter your password if prompted.
Step 2	configure terminal Example: Router# configure terminal	Enters global configuration mode.
Step 3	interface loopback <i>number</i> Example: Router(config)# interface loopback 0	Specifies a loopback interface and enters interface configuration mode. <ul style="list-style-type: none"> • Use the <i>number</i> argument to specify the number of the loopback interface that you want to create or configure. <p>Note There is no limit on the number of loopback interfaces that you can create.</p>
Step 4	ip address <i>ip-address mask</i> [secondary] Example:	Specifies an IP address for the loopback interface and enables IP processing on the interface.

	Command or Action	Purpose
	Router(config-if)# ip address 10.20.1.2 255.255.255.0	<ul style="list-style-type: none"> Use the <i>ip-address</i> and <i>mask</i> arguments to specify the subnet for the loopback address.
Step 5	end Example: Router(config-if)# end	Exits interface configuration mode and returns to privileged EXEC mode.
Step 6	show interfaces loopback <i>number</i> Example: Router# show interfaces loopback 0	(Optional) Displays information about loopback interfaces. <ul style="list-style-type: none"> Use the <i>number</i> argument to display information about one particular loopback interface. <p>Note Only the syntax applicable to this task is used in this example. For more details, see the Cisco IOS Interface and Hardware Component Command Reference.</p>
Step 7	exit Example: Router# exit	Exits privileged EXEC mode.

Examples

The following is sample output for the **show interfaces loopback** command.

```
Router# show interfaces loopback
Loopback0 is up, line protocol is up
  Hardware is Loopback
  Internet address is 10.20.1.2/24
  MTU 1514 bytes, BW 8000000 Kbit, DLY 5000 usec,
    reliability 255/255, txload 1/255, rxload 1/255
  Encapsulation LOOPBACK, loopback not set
  Last input never, output never, output hang never
  Last clearing of "show interface" counters never
  Input queue: 0/75/0/0 (size/max/drops/flushes); Total output drops: 0
  Queueing strategy: fifo
  Output queue: 0/0 (size/max)
  5 minute input rate 0 bits/sec, 0 packets/sec
  5 minute output rate 0 bits/sec, 0 packets/sec
    0 packets input, 0 bytes, 0 no buffer
    Received 0 broadcasts, 0 runts, 0 giants, 0 throttles
    0 input errors, 0 CRC, 0 frame, 0 overrun, 0 ignored, 0 abort
    0 packets output, 0 bytes, 0 underruns
    0 output errors, 0 collisions, 0 interface resets
    0 output buffer failures, 0 output buffers swapped out
```

Configuring a Null Interface

This task explains how to configure a null interface. Null interfaces provide an alternative method to access control lists for filtering traffic. All unwanted traffic can be directed to the null interface; the null interface cannot receive or forward traffic, or allow its traffic to be encapsulated.

The only interface configuration command that you can specify for the null interface is the **no ip unreachable**s command.

ICMP Unreachable Messages from Null Interfaces

To disable the sending of ICMP unreachable messages in response to packets sent to the null interface, use the **no ip unreachable**s command in interface configuration mode. To reenab the sending of ICMP unreachable messages in response to packets sent to the null interface, use the **ip unreachable**s command in interface configuration mode.

You can configure only one null interface on a device.

SUMMARY STEPS

1. **enable**
2. **configure terminal**
3. **interface null** *number*
4. **no ip unreachable**s
5. **end**
6. **show interfaces null** [*number*] [**accounting**]

DETAILED STEPS

	Command or Action	Purpose
Step 1	enable Example: Device> enable	Enables privileged EXEC mode. <ul style="list-style-type: none"> • Enter your password if prompted.
Step 2	configure terminal Example: Device# configure terminal	Enters global configuration mode.
Step 3	interface null <i>number</i> Example: Device(config)# interface null 0	Specifies a null interface and number, and enters interface configuration mode. <ul style="list-style-type: none"> • The number argument is always 0.
Step 4	no ip unreachable s Example: Device(config-if)# no ip unreachable	Prevents the generation of ICMP unreachable messages on an interface. <ul style="list-style-type: none"> • This command affects all types of ICMP unreachable messages.

	Command or Action	Purpose
Step 5	end Example: Device(config-if)# end	Exits to privileged EXEC mode.
Step 6	show interfaces null [number] [accounting] Example: Device# show interfaces null 0	(Optional) Displays information about null interfaces. <ul style="list-style-type: none"> • For null interfaces, the <i>number</i> argument is always 0. Note Only the syntax applicable to this task is used in this example. For more details, see the Cisco IOS Interface and Hardware Component Command Reference.

Examples

The following is sample output for the **show interfaces null** command.

```
Device# show interfaces null

Null0 is up, line protocol is up
  Hardware is Unknown
  MTU 1500 bytes, BW 10000000 Kbit, DLY 0 usec,
     reliability 0/255, txload 0/255, rxload 0/255
  Encapsulation ARPA, loopback not set
  Last input never, output never, output hang never
  Last clearing of "show interface" counters never
  Input queue: 0/75/0/0 (size/max/drops/flushes); Total output drops: 0
  5 minute input rate 0 bits/sec, 0 packets/sec
  5 minute output rate 0 bits/sec, 0 packets/sec
    0 packets input, 0 bytes, 0 no buffer
    Received 0 broadcasts, 0 runts, 0 giants, 0 throttles
    0 input errors, 0 CRC, 0 frame, 0 overrun, 0 ignored, 0 abort
    0 packets output, 0 bytes, 0 underruns
    0 output errors, 0 collisions, 0 interface resets
    0 output buffer failures, 0 output buffers swapped out
```

Configuring a Subinterface

This task explains how to configure a subinterface. Subinterfaces can be enabled and shut down independently of the physical port with which they are associated. However, you cannot enable a subinterface of a physical interface that has been shut down.

Before you begin

The IP address for the interface must be unique and not in use by another interface.

SUMMARY STEPS

1. **enable**
2. **configure terminal**

3. **interface** *type number.subinterface-number*
4. **ip address** *ip-address mask [secondary]*
5. **end**
6. **show interfaces** *type number.subinterface-number*
7. **exit**

DETAILED STEPS

	Command or Action	Purpose
Step 1	enable Example: <pre>Router> enable</pre>	Enables privileged EXEC mode. <ul style="list-style-type: none"> • Enter your password if prompted.
Step 2	configure terminal Example: <pre>Router# configure terminal</pre>	Enters global configuration mode.
Step 3	interface <i>type number.subinterface-number</i> Example: <pre>Router(config)# interface GigabitEthernet 2/3.5</pre>	Specifies the interface type, interface number, and subinterface number and enters interface configuration mode.
Step 4	ip address <i>ip-address mask [secondary]</i> Example: <pre>Router(config-if)# ip address 209.165.200.225 255.255.255.224</pre>	Specifies an IP address for the interface and enables IP processing on the interface.
Step 5	end Example: <pre>Router(config-if)# end</pre>	Exits interface configuration mode and returns to privileged EXEC mode.
Step 6	show interfaces <i>type number.subinterface-number</i> Example: <pre>Router# show interfaces GigabitEthernet 2/3.5</pre>	(Optional) Displays information about the interfaces.
Step 7	exit Example: <pre>Router# exit</pre>	Exits privileged EXEC mode.

Examples

The following is sample output from the **show interfaces** command:

```
Router# show interfaces GigabitEthernet 2/3.5
GigabitEthernet2/3.5432 is down, line protocol is down (notconnect)
  Hardware is c7600 1Gb 802.3, address is 001b.0de6.c100 (bia 001b.0de6.c100)
  Description: *sample*
  Internet address is 10.11.12.13/24
  MTU 1500 bytes, BW 1000000 Kbit, DLY 10 usec,
    reliability 255/255, txload 1/255, rxload 1/255
  Encapsulation 802.1Q Virtual LAN, Vlan ID 2339.
  ARP type: ARPA, ARP Timeout 04:00:00
  Keepalive set (10 sec)
  Last clearing of "show interface" counters never
```

Configuring a Subinterface

This task explains how to configure a subinterface. Subinterfaces can be enabled and shut down independently of the physical port with which they are associated. However, you cannot enable a subinterface of a physical interface that has been shut down.

Before you begin

The IP address for the interface must be unique and not in use by another interface.

SUMMARY STEPS

1. **enable**
2. **configure terminal**
3. **interface** *type number.subinterface-number*
4. **ip address** *ip-address mask [secondary]*
5. **end**
6. **show interfaces** *type number.subinterface-number*
7. **exit**

DETAILED STEPS

	Command or Action	Purpose
Step 1	enable Example: Router> enable	Enables privileged EXEC mode. <ul style="list-style-type: none"> • Enter your password if prompted.
Step 2	configure terminal Example: Router# configure terminal	Enters global configuration mode.

	Command or Action	Purpose
Step 3	interface <i>type number.subinterface-number</i> Example: Router(config)# interface GigabitEthernet 2/3.5	Specifies the interface type, interface number, and subinterface number and enters interface configuration mode.
Step 4	ip address <i>ip-address mask [secondary]</i> Example: Router(config-if)# ip address 209.165.200.225 255.255.255.224	Specifies an IP address for the interface and enables IP processing on the interface.
Step 5	end Example: Router(config-if)# end	Exits interface configuration mode and returns to privileged EXEC mode.
Step 6	show interfaces <i>type number.subinterface-number</i> Example: Router# show interfaces GigabitEthernet 2/3.5	(Optional) Displays information about the interfaces.
Step 7	exit Example: Router# exit	Exits privileged EXEC mode.

Examples

The following is sample output from the **show interfaces** command:

```
Router# show interfaces GigabitEthernet 2/3.5
GigabitEthernet2/3.5432 is down, line protocol is down (notconnect)
  Hardware is c7600 1Gb 802.3, address is 001b.0de6.c100 (bia 001b.0de6.c100)
  Description: *sample*
  Internet address is 10.11.12.13/24
  MTU 1500 bytes, BW 1000000 Kbit, DLY 10 usec,
     reliability 255/255, txload 1/255, rxload 1/255
  Encapsulation 802.1Q Virtual LAN, Vlan ID 2339.
  ARP type: ARPA, ARP Timeout 04:00:00
  Keepalive set (10 sec)
  Last clearing of "show interface" counters never
```

Configuring Logical Layer 3 VLAN Interfaces

Before you begin

Before you configure logical Layer 3 VLAN interfaces, you must create and configure the VLANs on the device, assign VLAN membership to the Layer 2 interfaces, enable IP routing if IP routing is disabled, and specify an IP routing protocol.

SUMMARY STEPS

1. **configure terminal**
2. **interface vlan** *vlan ID*
3. **ip address** *ip_address subnet_mask*
4. **no shutdown**
5. **end**

DETAILED STEPS

	Command or Action	Purpose
Step 1	configure terminal Example: Device# configure terminal	Enters global configuration mode.
Step 2	interface vlan <i>vlan ID</i> Example: Device(config)# interface vlan <i>vlan_ID</i>	Selects an interface to configure.
Step 3	ip address <i>ip_address subnet_mask</i> Example: Device(config-if)# ip address <i>ip_address</i> <i>subnet_mask</i>	Configures the IP address and IP subnet.
Step 4	no shutdown Example: Device(config-if)# no shutdown	Enables the interface.
Step 5	end Example: Device(config-if)# end	Exits the configuration mode.

Examples

The following is sample output from the **show interface vlan** command, which displays the interface IP address configuration and status of Layer 3 VLAN interface *vlan 2*

```
Device# show interface vlan
Vlan2 is up, line protocol is down
  Hardware is Ethernet SVI, address is 00D.588F.B604 (bia 00D.588F.B604)
```

```

Internet address is 172.20.52.106/29
MTU 1500 bytes, BW 1000000 Kbit, DLY 10 usec,
    reliability 255/255, txload 1/255, rxload 1/255
Encapsulation ARPA, loopback not set
ARP type: ARPA, ARP Timeout 04:00:00
Last input never, output never, output hang never
Last clearing of "show interface" counters never
Input queue: 0/75/0/0 (size/max/drops/flushes); Total output drops: 0
Queueing strategy: fifo
Output queue: 0/40 (size/max)
5 minute input rate 0 bits/sec, 0 packets/sec
5 minute output rate 0 bits/sec, 0 packets/sec
    0 packets input, 0 bytes, 0 no buffer
    Received 0 broadcasts, 0 runts, 0 giants, 0 throttles
    0 input errors, 0 CRC, 0 frame, 0 overrun, 0 ignored
    0 packets output, 0 bytes, 0 underruns
    0 output errors, 0 interface resets
    0 output buffer failures, 0 output buffers swapped out

```

Configuration Examples for Virtual Interfaces

Example Configuring a Loopback Interface

The following example shows the configuration sequence of a loopback interface, loopback 0:

```

interface loopback 0
ip address 209.165.200.225 255.255.255.0
end

```

Example Configuring a Null Interface

The following example shows the configuration sequence of a null interface and how to drop the ICMP unreachable messages. All packets sent to the null interface are dropped and in this example, the ICMP messages usually sent in response to packets being sent to the null interface are dropped.

```

interface null 0
no ip unreachable
end

```

Example Configuring a Subinterface

The following example shows the configuration sequence of a subinterface:

```

interface GigabitEthernet 2/3.5
description *sample*
encapsulation dot1Q 2339
ip address 209.165.200.225 255.255.255.224
end

```

Where to Go Next

- If you want to implement tunnels in your network, see the "Implementing Tunnels" module of the *Cisco IOS XE Interface and Hardware Component Configuration Guide*.
- If you want to implement physical (hardware) interfaces (such as Gigabit Ethernet or serial interfaces) in your network, see the "Configuring Physical Interfaces" module of the *Cisco IOS XE Interface and Hardware Component Configuration Guide*.

Additional References

Related Documents

Related Topic	Document Title
Cisco IOS commands	Cisco IOS Master Commands List, All Releases
Interface commands: complete command syntax, command mode, defaults, command history, usage guidelines, and examples	<i>Cisco IOS Interface and Hardware Component Command Reference</i>
Cisco IOS XE Interface and Hardware Component configuration modules	<i>Cisco IOS XE Interface and Hardware Component Configuration Guide</i>
Configuration example showing how to use loopback interfaces with BGP	Sample Configuration for iBGP and eBGP With or Without a Loopback Address

Standards

Standard	Title
No new or modified standards are supported, and support for existing standards has not been modified.	--

MIBs

MIB	MIBs Link
No new or modified MIBs are supported, and support for existing MIBs has not been modified.	To locate and download MIBs for selected platforms, Cisco software releases, and feature sets, use Cisco MIB Locator found at the following URL: http://www.cisco.com/go/mibs

RFCs

RFC	Title
No new or modified RFCs are supported, and support for existing RFCs has not been modified.	--

Technical Assistance

Description	Link
The Cisco Support and Documentation website provides online resources to download documentation, software, and tools. Use these resources to install and configure the software and to troubleshoot and resolve technical issues with Cisco products and technologies. Access to most tools on the Cisco Support and Documentation website requires a Cisco.com user ID and password.	http://www.cisco.com/cisco/web/support/index.html



CHAPTER 7

Implementing Tunnels

This module describes the various types of tunneling techniques. Configuration details and examples are provided for the tunnel types that use physical or virtual interfaces. Many tunneling techniques are implemented using technology-specific commands, and links are provided to the appropriate technology modules.

Tunneling provides a way to encapsulate arbitrary packets inside a transport protocol. Tunnels are implemented as virtual interfaces to provide a simple interface for configuration purposes. The tunnel interface is not tied to specific “passenger” or “transport” protocols, but rather is an architecture to provide the services necessary to implement any standard point-to-point encapsulation scheme.



Note Cisco ASR 1000 Series Aggregation Services Routers support VPN routing and forwarding (VRF)-aware generic routing encapsulation (GRE) tunnel keepalive features.

- [Finding Feature Information, on page 51](#)
- [Restrictions for Implementing Tunnels, on page 51](#)
- [Information About Implementing Tunnels, on page 52](#)
- [How to Implement Tunnels, on page 56](#)
- [Configuration Examples for Implementing Tunnels, on page 65](#)
- [Additional References, on page 69](#)
- [Feature Information for Implementing Tunnels, on page 71](#)

Finding Feature Information

Your software release may not support all the features documented in this module. For the latest caveats and feature information, see [Bug Search Tool](#) and the release notes for your platform and software release. To find information about the features documented in this module, and to see a list of the releases in which each feature is supported, see the feature information table.

Use Cisco Feature Navigator to find information about platform support and Cisco software image support. To access Cisco Feature Navigator, go to www.cisco.com/go/cfn. An account on Cisco.com is not required.

Restrictions for Implementing Tunnels

- It is important to allow the tunnel protocol to pass through a firewall and access control list (ACL) check.

- Multiple point-to-point tunnels can saturate the physical link with routing information if the bandwidth is not configured correctly on a tunnel interface.
- A tunnel looks like a single hop link, and routing protocols may prefer a tunnel over a multihop physical path. The tunnel, despite looking like a single hop link, may traverse a slower path than a multihop link. A tunnel is as robust and fast, or as unreliable and slow, as the links that it actually traverses. Routing protocols that make their decisions based only on hop counts will often prefer a tunnel over a set of physical links. A tunnel might appear to be a one-hop, point-to-point link and have the lowest-cost path, but the tunnel may actually cost more in terms of latency when compared to an alternative physical topology. For example, in the topology shown in the figure below, packets from Host 1 will appear to travel across networks w, t, and z to get to Host 2 instead of taking the path w, x, y, and z because the tunnel hop count appears shorter. In fact, the packets going through the tunnel will still be traveling across Router A, B, and C, but they must also travel to Router D before coming back to Router C.

Figure 2: Tunnel Precautions: Hop Counts

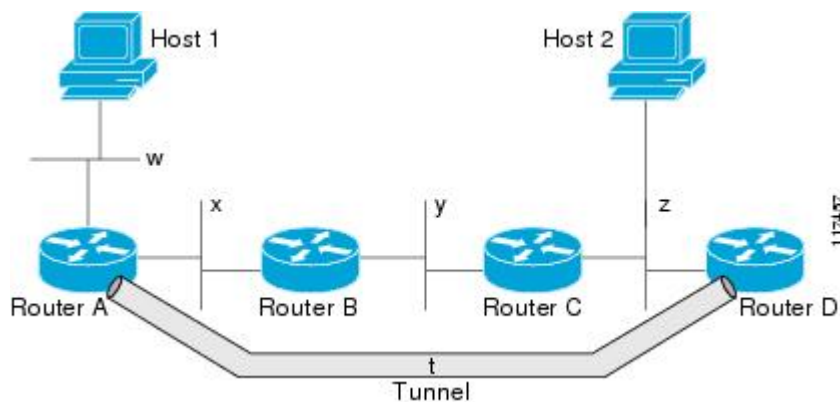

- A tunnel may have a recursive routing problem if routing is not configured accurately. The best path to a tunnel destination is via the tunnel itself; therefore recursive routing causes the tunnel interface to flap. To avoid recursive routing problems, keep the control-plane routing separate from the tunnel routing by using the following methods:
 - Use a different autonomous system number or tag.
 - Use a different routing protocol.
 - Ensure that static routes are used to override the first hop (watch for routing loops).

The following error is displayed when there is recursive routing to a tunnel destination:

```
%TUN-RECURDOWN Interface Tunnel 0
temporarily disabled due to recursive routing
```

Information About Implementing Tunnels

Tunneling Versus Encapsulation

To understand how tunnels work, you must be able to distinguish between concepts of encapsulation and tunneling. Encapsulation is the process of adding headers to data at each layer of a particular protocol stack. The Open Systems Interconnection (OSI) reference model describes the functions of a network. To send a

data packet from one host (for example, a PC) to another on a network, encapsulation is used to add a header in front of the data packet at each layer of the protocol stack in descending order. The header must contain a data field that indicates the type of data encapsulated at the layer immediately above the current layer. As the packet ascends the protocol stack on the receiving side of the network, each encapsulation header is removed in reverse order.

Tunneling encapsulates data packets from one protocol within a different protocol and transports the packets on a foreign network. Unlike encapsulation, tunneling allows a lower-layer protocol and a same-layer protocol to be carried through the tunnel. A tunnel interface is a virtual (or logical) interface. Tunneling consists of three main components:

- Passenger protocol—The protocol that you are encapsulating. For example, IPv4 and IPv6 protocols.
- Carrier protocol—The protocol that encapsulates. For example, generic routing encapsulation (GRE) and Multiprotocol Label Switching (MPLS).
- Transport protocol--The protocol that carries the encapsulated protocol. The main transport protocol is IP.

Tunnel ToS

Tunnel type of service (ToS) allows you to tunnel network traffic and group all packets in the same ToS byte value. The ToS byte values and Time-to-Live (TTL) hop-count value can be set in the encapsulating IP header of tunnel packets for an IP tunnel interface on a router. Tunnel ToS feature is supported for Cisco Express Forwarding (formerly known as CEF), fast switching, and process switching.

The ToS and TTL byte values are defined in RFC 791. RFC 2474, and RFC 2780 obsolete the use of the ToS byte as defined in RFC 791. RFC 791 specifies that bits 6 and 7 of the ToS byte (the first two least significant bits) are reserved for future use and should be set to 0.

EoMPLS over GRE

Ethernet over MPLS (EoMPLS) is a tunneling mechanism that allows you to tunnel Layer 2 traffic through a Layer 3 MPLS network. EoMPLS is also known as Layer 2 tunneling.

EoMPLS effectively facilitates Layer 2 extension over long distances. EoMPLS over GRE helps you to create the GRE tunnel as hardware-based switched, and encapsulates EoMPLS frames within the GRE tunnel. The GRE connection is established between the two core routers, and then the MPLS label switched path (LSP) is tunneled over.

GRE encapsulation is used to define a packet that has header information added to it prior to being forwarded. De-encapsulation is the process of removing the additional header information when the packet reaches the destination tunnel endpoint.

When a packet is forwarded through a GRE tunnel, two new headers are added to the front of the packet and hence the context of the new payload changes. After encapsulation, what was originally the data payload and separate IP header are now known as the GRE payload. A GRE header is added to the packet to provide information on the protocol type and the recalculated checksum. A new IP header is also added to the front of the GRE header. This IP header contains the destination IP address of the tunnel.

The GRE header is added to packets such as IP, Layer 2 VPN, and Layer 3 VPN before the header enters into the tunnel. All routers along the path that receives the encapsulated packet use the new IP header to determine how the packet can reach the tunnel endpoint.

In IP forwarding, on reaching the tunnel destination endpoint, the new IP header and the GRE header are removed from the packet and the original IP header is used to forward the packet to the final destination.

The EoMPLS over GRE feature removes the new IP header and GRE header from the packet at the tunnel destination, and the MPLS label is used to forward the packet to the appropriate Layer 2 attachment circuit or Layer 3 VRF.

The scenarios in the following sections describe the L2VPN and L3VPN over GRE deployment on provider edge (PE) or provider (P) routers:

Provider Edge to Provider Edge Generic Routing EncapsulationTunnels

In the Provider Edge to Provider Edge (PE) GRE tunnels scenario, a customer does not transition any part of the core to MPLS but prefers to offer EoMPLS and basic MPLS VPN services. Therefore, GRE tunneling of MPLS traffic is done between PEs.

Provider to Provider Generic Routing Encapsulation Tunnels

In the Provider to Provider (P) GRE tunnels scenario, Multiprotocol Label Switching (MPLS) is enabled between Provider Edge (PE) and P routers but the network core can either have non-MPLS aware routers or IP encryption boxes. In this scenario, GRE tunneling of the MPLS labeled packets is done between P routers.

Provider Edge to Provider Generic Routing Encapsulation Tunnels

In a Provider Edge to Provider GRE tunnels scenario, a network has MPLS-aware P to P nodes. GRE tunneling is done between a PE to P non-MPLS network segment.

Features Specific to Generic Routing Encapsulation

You should understand the following configurations and information for a deployment scenario:

- Tunnel endpoints can be loopbacks or physical interfaces.
- Configurable tunnel keepalive timer parameters per endpoint and a syslog message must be generated when the keepalive timer expires.
- Bidirectional forwarding detection (BFD) is supported for tunnel failures and for the Interior Gateway Protocol (IGP) that use tunnels.
- IGP load sharing across a GRE tunnel is supported.
- IGP redundancy across a GRE tunnel is supported.
- Fragmentation across a GRE tunnel is supported.
- Ability to pass jumbo frames is supported.
- All IGP control plane traffic is supported.
- IP ToS preservation across tunnels is supported.
- A tunnel should be independent of the endpoint physical interface type; for example, ATM, Gigabit, Packet over SONET (POS), and TenGigabit.
- Up to 100 GRE tunnels are supported.

Features Specific to Ethernet over MPLS

- Any Transport over MPLS (AToM) sequencing.
- IGP load sharing and redundancy.
- Port mode Ethernet over MPLS (EoMPLS).
- Pseudowire redundancy.
- Support for up to 200 EoMPLS virtual circuits (VCs).
- Tunnel selection and the ability to map a specific pseudowire to a GRE tunnel.
- VLAN mode EoMPLS.

Features Specific to Multiprotocol Label Switching Virtual Private Network

- Support for the PE role with IPv4 VRF.
- Support for all PE to customer edge (CE) protocols.
- Load sharing through multiple tunnels and also equal cost IGP paths with a single tunnel.
- Support for redundancy through unequal cost IGP paths with a single tunnel.
- Support for the IP precedence value being copied onto the expression (EXP) bits field of the Multiprotocol Label Switching (MPLS) label and then onto the precedence bits on the outer IPv4 ToS field of the generic routing encapsulation (GRE) packet.

See the section, “[Example: Configuring EoMPLS over GRE](#)” for a sample configuration sequence of EoMPLS over GRE. For more details on EoMPLS over GRE, see the [Deploying and Configuring MPLS Virtual Private Networks In IP Tunnel Environments](#) document.

Path MTU Discovery

Path MTU Discovery (PMTUD) can be enabled on a GRE or IP-in-IP tunnel interface. When PMTUD (RFC 1191) is enabled on a tunnel interface, the router performs PMTUD processing for the GRE (or IP-in-IP) tunnel IP packets. The router always performs PMTUD processing on the original data IP packets that enter the tunnel. When PMTUD is enabled, packet fragmentation is not permitted for packets that traverse the tunnel because the Don't Fragment (DF) bit is set on all the packets. If a packet that enters the tunnel encounters a link with a smaller MTU, the packet is dropped and an Internet Control Message Protocol (ICMP) message is sent back to the sender of the packet. This message indicates that fragmentation was required (but not permitted) and provides the MTU of the link that caused the packet to be dropped.



Note PMTUD on a tunnel interface requires that the tunnel endpoint be able to receive ICMP messages generated by routers in the path of the tunnel. Ensure that ICMP messages can be received before using PMTUD over firewall connections.

Use the **tunnel path-mtu-discovery** command to enable PMTUD for the tunnel packets and use the **show interfaces tunnel** command to verify the tunnel PMTUD parameters. PMTUD works only on GRE and IP-in-IP tunnel interfaces.

QoS Options for Tunnels

A tunnel interface supports various quality of service (QoS) features as a physical interface. QoS provides a way to ensure that mission-critical traffic has an acceptable level of performance. QoS options for tunnels include support for applying generic traffic shaping (GTS) directly on the tunnel interface and support for class-based shaping using the modular QoS CLI (MQC). Tunnel interfaces also support class-based policing, but they do not support committed access rate (CAR).

GRE tunnels allow the router to copy the IP precedence bit values of the ToS byte to the tunnel or the GRE IP header that encapsulates the inner packet. Intermediate routers between the tunnel endpoints can use the IP precedence values to classify packets for QoS features such as policy routing, weighted fair queuing (WFQ), and weighted random early detection (WRED).

When packets are encapsulated by tunnel or encryption headers, QoS features are unable to examine the original packet headers and correctly classify the packets. Packets that travel across the same tunnel have the same tunnel headers, so the packets are treated identically if the physical interface is congested. Tunnel packets can, however, be classified before tunneling and encryption can occur when a user applies the QoS preclassify feature on the tunnel interface or on the crypto map.



Note Class-based WFQ (CBWFQ) inside class-based shaping is not supported on a multipoint interface.

For examples of how to implement some QoS features on a tunnel interface, see the section “[Configuring QoS Options on Tunnel Interfaces Examples, on page 68](#)” on page 32.

How to Implement Tunnels

Determining the Tunnel Type

Before configuring a tunnel, you must determine the type of tunnel you want to create.

SUMMARY STEPS

1. Determine the passenger protocol. A passenger protocol is the protocol that you are encapsulating.
2. Determine the **tunnel mode** command keyword, if appropriate.

DETAILED STEPS

Step 1 Determine the passenger protocol. A passenger protocol is the protocol that you are encapsulating.

Step 2 Determine the **tunnel mode** command keyword, if appropriate.

The table below shows how to determine the appropriate keyword to be used with the **tunnel mode** command.

Table 6: Determining the tunnel mode Command Keyword

Keyword	Purpose
dvmrp	Use the dvmrp keyword to specify that the Distance Vector Multicast Routing Protocol encapsulation will be used.
gre ip	Use the gre and ip keywords to specify that GRE encapsulation over IP will be used.
gre ipv6	Use the gre and ipv6 keywords to specify that GRE encapsulation over IPv6 will be used.
ipip [decapsulate-any]	Use the ipip keyword to specify that IP-in-IP encapsulation will be used. The optional decapsulate-any keyword terminates any number of IP-in-IP tunnels at one tunnel interface. Note that this tunnel will not carry any outbound traffic; however, any number of remote tunnel endpoints can use a tunnel configured as their destination.
ipv6	Use the ipv6 keyword to specify that generic packet tunneling in IPv6 will be used.
ipv6ip	Use the ipv6ip keyword to specify that IPv6 will be used as the passenger protocol and IPv4 as both the carrier (encapsulation) and transport protocol. When additional keywords are not used, manual IPv6 tunnels are configured. Additional keywords can be used to specify IPv4-compatible, 6to4, or ISATAP tunnels.
mpls	Use the mpls keyword to specify that MPLS will be used for configuring traffic engineering (TE) tunnels.

Configuring an IPv4 GRE Tunnel

Perform this task to configure a GRE tunnel. A tunnel interface is used to pass protocol traffic across a network that does not normally support the protocol. To build a tunnel, you must define a tunnel interface on each of the two routers, and the tunnel interfaces must reference each other. At each router, the tunnel interface must be configured with a Layer 3 address. The tunnel endpoints, tunnel source, and tunnel destination must be defined, and the type of tunnel must be selected. Optional steps can be performed to customize the tunnel.

Remember to configure the router at each end of the tunnel. If only one side of a tunnel is configured, the tunnel interface may still come up and stay up (unless keepalive is configured), but packets going into the tunnel will be dropped.

GRE Tunnel Keepalive

Keepalive packets can be configured to be sent over IP-encapsulated GRE tunnels. You can specify the rate at which keepalives are sent and the number of times that a device will continue to send keepalive packets without a response before the interface becomes inactive. GRE keepalive packets may be sent from both sides of a tunnel or from just one side.

Before you begin

Ensure that the physical interface to be used as the tunnel source in this task is up and configured with the appropriate IP address. For hardware technical descriptions and information about installing interfaces, see the hardware installation and configuration publication for your product.

SUMMARY STEPS

1. **enable**
2. **configure terminal**
3. **interface** *type number*
4. **bandwidth** *kb/s*
5. **keepalive** [*period* [*retries*]]
6. **tunnel source** {*ip-address* | *interface-type interface-number*}
7. **tunnel destination** {*hostname* | *ip-address*}
8. **tunnel key** *key-number*
9. **tunnel mode gre** { **ip** | **multipoint**}
10. **ip mtu** *bytes*
11. **ip tcp mss** *mss-value*
12. **tunnel path-mtu-discovery** [**age-timer** {*aging-mins* | **infinite**}]
13. **end**

DETAILED STEPS

	Command or Action	Purpose
Step 1	enable Example: Router> enable	Enables privileged EXEC mode. • Enter your password if prompted.
Step 2	configure terminal Example: Router# configure terminal	Enters global configuration mode.
Step 3	interface <i>type number</i> Example: Router(config)# interface tunnel 0	Specifies the interface type and number, and enters interface configuration mode. • To configure a tunnel, use tunnel for the <i>type</i> argument.
Step 4	bandwidth <i>kb/s</i> Example: Router(config-if)# bandwidth 1000	Sets the current bandwidth value for an interface and communicates it to higher-level protocols. • Specifies the tunnel bandwidth to be used to transmit packets. • Use the <i>kb/s</i> argument to set the bandwidth, in kilobits per second (kb/s). Note This is only a routing parameter; it does not affect the physical interface. The default bandwidth setting on a tunnel interface is 9.6 kb/s. You should set the bandwidth on a tunnel to an appropriate value.

	Command or Action	Purpose
Step 5	<p>keepalive [<i>period</i> [<i>retries</i>]]</p> <p>Example:</p> <pre>Router(config-if)# keepalive 3 7</pre>	<p>(Optional) Specifies the number of times the device will continue to send keepalive packets without response before bringing the tunnel interface protocol down.</p> <ul style="list-style-type: none"> GRE keepalive packets may be configured either on only one side of the tunnel or on both. If GRE keepalive is configured on both sides of the tunnel, the <i>period</i> and <i>retries</i> arguments can be different at each side of the link. <p>Note This command is supported only on GRE point-to-point tunnels.</p>
Step 6	<p>tunnel source {<i>ip-address</i> <i>interface-type interface-number</i>}</p> <p>Example:</p> <pre>Router(config-if)# tunnel source GigabitEthernet 0/0/0</pre>	<p>Configures the tunnel source.</p> <ul style="list-style-type: none"> Use the <i>ip-address</i> argument to specify the source IP address. Use the <i>interface-type</i> and <i>interface-number</i> arguments to specify the interface to be used. <p>Note The tunnel source IP address and destination IP addresses must be defined on two separate devices.</p>
Step 7	<p>tunnel destination {<i>hostname</i> <i>ip-address</i>}</p> <p>Example:</p> <pre>Router(config-if)# tunnel destination 10.0.2.1</pre>	<p>Configures the tunnel destination.</p> <ul style="list-style-type: none"> Use the <i>hostname</i> argument to specify the name of the host destination. Use the <i>ip-address</i> argument to specify the IP address of the host destination. <p>Note The tunnel source and destination IP addresses must be defined on two separate devices.</p>
Step 8	<p>tunnel key <i>key-number</i></p> <p>Example:</p> <pre>Router(config-if)# tunnel key 1000</pre>	<p>(Optional) Enables an ID key for a tunnel interface.</p> <ul style="list-style-type: none"> Use the <i>key-number</i> argument to identify a tunnel key that is carried in each packet. Tunnel ID keys can be used as a form of weak security to prevent improper configuration or injection of packets from a foreign source. <p>Note This command is supported only on GRE tunnel interfaces. We do not recommend relying on this key for security purposes.</p>

	Command or Action	Purpose
Step 9	tunnel mode gre { ip multipoint} Example: <pre>Device(config-if)# tunnel mode gre ip</pre>	Specifies the encapsulation protocol to be used in the tunnel. <ul style="list-style-type: none"> • Use the gre ip keywords to specify that GRE over IP encapsulation will be used. • Use the gre multipoint keywords to specify that multipoint GRE (mGRE) will be used.
Step 10	ip mtu bytes Example: <pre>Device(config-if)# ip mtu 1400</pre>	(Optional) Sets the MTU size of IP packets sent on an interface. <ul style="list-style-type: none"> • If an IP packet exceeds the MTU set for the interface, the Cisco software will fragment it unless the DF bit is set. • All devices on a physical medium must have the same protocol MTU in order to operate. • For IPv6 packets, use the ipv6 mtu command. <p>Note If the tunnel path-mtu-discovery command is enabled do not configure this command.</p>
Step 11	ip tcp mss mss-value Example: <pre>Device(config-if)# ip tcp mss 250</pre>	(Optional) Specifies the maximum segment size (MSS) for TCP connections that originate or terminate on a router. <ul style="list-style-type: none"> • Use the <i>mss-value</i> argument to specify the maximum segment size for TCP connections, in bytes.
Step 12	tunnel path-mtu-discovery [age-timer {aging-mins infinite}] Example: <pre>Device(config-if)# tunnel path-mtu-discovery</pre>	(Optional) Enables PMTUD on a GRE or IP-in-IP tunnel interface. <ul style="list-style-type: none"> • When PMTUD is enabled on a tunnel interface, PMTUD will operate for GRE IP tunnel packets to minimize fragmentation in the path between the tunnel endpoints.
Step 13	end Example: <pre>Device(config-if)# end</pre>	Exits interface configuration mode and returns to privileged EXEC mode.

What to Do Next

Proceed to the “Verifying Tunnel Configuration and Operation” section.

Configuring 6to4 Tunnels

Before you begin

With 6to4 tunnels, the tunnel destination is determined by the border-router IPv4 address, which is concatenated to the prefix 2002::/16 in the format 2002:*border-router-IPv4-address* ::/48. The border router at each end of a 6to4 tunnel must support both the IPv4 and IPv6 protocol stacks.



Note The configuration of only one IPv4-compatible tunnel and one 6to4 IPv6 tunnel is supported on a router. If you choose to configure both of these tunnel types on the same router, Cisco recommends that they not share the same tunnel source.

A 6to4 tunnel and an IPv4-compatible tunnel cannot share the same interface because both of them are NBMA “point-to-multipoint” access links, and only the tunnel source can be used to reorder the packets from a multiplexed packet stream into a single packet stream for an incoming interface. When a packet with an IPv4 protocol type of 41 arrives on an interface, the packet is mapped to an IPv6 tunnel interface on the basis of the IPv4 address. However, if both the 6to4 tunnel and the IPv4-compatible tunnel share the same source interface, the router cannot determine the IPv6 tunnel interface to which it should assign the incoming packet.

Manually configured IPv6 tunnels can share the same source interface because a manual tunnel is a “point-to-point” link, and both IPv4 source and the IPv4 destination of the tunnel are defined.

SUMMARY STEPS

1. **enable**
2. **configure terminal**
3. **interface tunnel** *tunnel-number*
4. **ipv6 address** *ipv6-prefix/prefix-length* [**eui-64**]
5. **tunnel source** {*ip-address* | *interface-type interface-number*}
6. **tunnel mode ipv6ip 6to4**
7. **exit**
8. **ipv6 route** *ipv6-prefix / prefix-length* **tunnel** *tunnel-number*
9. **end**

DETAILED STEPS

	Command or Action	Purpose
Step 1	enable Example: Router> enable	Enables privileged EXEC mode. • Enter your password if prompted.
Step 2	configure terminal Example: Router# configure terminal	Enters global configuration mode.
Step 3	interface tunnel <i>tunnel-number</i> Example:	Specifies a tunnel interface and number and enters interface configuration mode.

	Command or Action	Purpose
	Router(config)# interface tunnel 0	
Step 4	ipv6 address <i>ipv6-prefix/prefix-length</i> [eui-64] Example: Router(config-if)# ipv6 address 2002:c0a8:6301:1::1/64	Specifies the IPv6 address assigned to the interface and enables IPv6 processing on the interface. <ul style="list-style-type: none"> The 32 bits following the initial 2002::/16 prefix correspond to an IPv4 address assigned to the tunnel source. Note See the "Configuring Basic Connectivity for IPv6" module for more information on configuring IPv6 addresses.
Step 5	tunnel source { <i>ip-address</i> <i>interface-type interface-number</i> } Example: Router(config-if)# tunnel source GigabitEthernet 0/0/0	Specifies the source IPv4 address or the source interface type and number for the tunnel interface. Note The interface type and number specified in the tunnel source command must be configured with an IPv4 address.
Step 6	tunnel mode ipv6ip 6to4 Example: Router(config-if)# tunnel mode ipv6ip 6to4	Specifies an IPv6 overlay tunnel using a 6to4 address.
Step 7	exit Example: Router(config-if)# exit	Exits interface configuration mode and returns to global configuration mode.
Step 8	ipv6 route <i>ipv6-prefix / prefix-length</i> tunnel <i>tunnel-number</i> Example: Router(config)# ipv6 route 2002::/16 tunnel 0	Configures a static route to the specified tunnel interface. Note When configuring a 6to4 overlay tunnel, you must configure a static route for the IPv6 6to4 prefix 2002::/16 to the 6to4 tunnel interface. <ul style="list-style-type: none"> The tunnel number specified in the ipv6 route command must be the same tunnel number specified in the interface tunnel command.
Step 9	end Example: Router(config)# end	Exits global configuration mode and returns to privileged EXEC mode.

What to Do Next

Proceed to the “Verifying Tunnel Configuration and Operation” section.

Verifying Tunnel Configuration and Operation

The **show** and **ping** commands in the steps below can be used in any sequence. The following commands can be used for GRE tunnels, IPv6 manually configured tunnels, and IPv6 over IPv4 GRE tunnels.

SUMMARY STEPS

1. **enable**
2. **show interfaces tunnel** *number* [**accounting**]
3. **ping** [*protocol*] *destination*
4. **show ip route** [*address* [*mask*]]
5. **ping** [*protocol*] *destination*

DETAILED STEPS

Step 1 **enable**

Enables privileged EXEC mode. Enter your password if prompted.

Example:

```
Device> enable
```

Step 2 **show interfaces tunnel** *number* [**accounting**]

Two routers are configured to be endpoints of a tunnel. Device A has Gigabit Ethernet interface 0/0/0 configured as the source for tunnel interface 0 with an IPv4 address of 10.0.0.1 and an IPv6 prefix of 2001:0DB8:1111:2222::1/64. Device B has Gigabit Ethernet interface 0/0/0 configured as the source for tunnel interface 1 with an IPv4 address of 10.0.0.2 and an IPv6 prefix of 2001:0DB8:1111:2222::2/64.

To verify that the tunnel source and destination addresses are configured, use the **show interfaces tunnel** command on Device A.

Example:

```
Device A# show interfaces tunnel 0

Tunnel0 is up, line protocol is up
  Hardware is Tunnel
  MTU 1514 bytes, BW 9 Kbit, DLY 500000 usec,
     reliability 255/255, txload 1/255, rxload 1/255
  Encapsulation TUNNEL, loopback not set
  Keepalive not set
  Tunnel source 10.0.0.1 (GigabitEthernet0/0/0), destination 10.0.0.2, fastswitch TTL 255
  Tunnel protocol/transport GRE/IP, key disabled, sequencing disabled
  Tunnel TTL 255
  Checksumming of packets disabled, fast tunneling enabled
  Last input 00:00:14, output 00:00:04, output hang never
  Last clearing of "show interface" counters never
  Input queue: 0/75/0/0 (size/max/drops/flushes); Total output drops: 0
  Queueing strategy: fifo
  Output queue :0/0 (size/max)
  5 minute input rate 0 bits/sec, 0 packets/sec
  5 minute output rate 0 bits/sec, 0 packets/sec
    4 packets input, 352 bytes, 0 no buffer
    Received 0 broadcasts, 0 runts, 0 giants, 0 throttles
    0 input errors, 0 CRC, 0 frame, 0 overrun, 0 ignored, 0 abort
```

```

8 packets output, 704 bytes, 0 underruns
0 output errors, 0 collisions, 0 interface resets
0 output buffer failures, 0 output buffers swapped out

```

Step 3 ping *[protocol] destination*

To check that the local endpoint is configured and working, use the **ping** command on Device A.

Example:

```

DeviceA# ping 2001:0DB8:1111:2222::2

Type escape sequence to abort.
Sending 5, 100-byte ICMP Echos to 2001:0DB8:1111:2222::2, timeout is 2 seconds:
!!!!
Success rate is 100 percent (5/5), round-trip min/avg/max = 20/20/20 ms

```

Step 4 show ip route *[address [mask]]*

To check that a route exists to the remote endpoint address, use the **show ip route** command.

Example:

```

DeviceA# show ip route 10.0.0.2

Routing entry for 10.0.0.0/24
  Known via "connected", distance 0, metric 0 (connected, via interface)
  Routing Descriptor Blocks:
  * directly connected, via GigabitEthernet0/0/0
    Route metric is 0, traffic share count is 1

```

Step 5 ping *[protocol] destination*

To check that the remote endpoint address is reachable, use the **ping** command on Device A.

Note The remote endpoint address may not be reachable using the **ping** command because of filtering, but the tunnel traffic may still reach its destination.

Example:

```

DeviceA# ping 10.0.0.2

Type escape sequence to abort.
Sending 5, 100-byte ICMP Echos to 10.0.0.2, timeout is 2 seconds:
!!!!
Success rate is 100 percent (5/5), round-trip min/avg/max = 20/21/28 ms

```

To check that the remote IPv6 tunnel endpoint is reachable, use the **ping** command again on Device A. The note regarding filtering earlier in step also applies to this example.

Example:

```

DeviceA# ping 2001:0DB8:1111:2222::2

Type escape sequence to abort.
Sending 5, 100-byte ICMP Echos to 1::2, timeout is 2 seconds:
!!!!
Success rate is 100 percent (5/5), round-trip min/avg/max = 20/20/20 ms

```

These steps may be repeated at the other endpoint of the tunnel.

Configuration Examples for Implementing Tunnels

Example: Configuring a GRE IPv4 Tunnel

The following example shows a simple configuration of GRE tunneling. Note that Gigabit Ethernet interface 0/0/1 is the tunnel source for Router A and the tunnel destination for Router B. Fast Ethernet interface 0/0/1 is the tunnel source for Router B and the tunnel destination for Router A.

Router A

```
interface Tunnel 0
 ip address 10.1.1.2 255.255.255.0
 tunnel source GigabitEthernet 0/0/1
 tunnel destination 192.168.3.2
 tunnel mode gre ip
!
interface GigabitEthernet 0/0/1
 ip address 192.168.4.2 255.255.255.0
```

Router B

```
interface Tunnel 0
 ip address 10.1.1.1 255.255.255.0
 tunnel source FastEthernet 0/0/1
 tunnel destination 192.168.4.2
 tunnel mode gre ip
!
interface FastEthernet 0/0/1
 ip address 192.168.3.2 255.255.255.0
```

The following example configures a GRE tunnel running both IS-IS and IPv6 traffic between Router A and Router B:

Router A

```
ipv6 unicast-routing
clns routing
!
interface Tunnel 0
 no ip address
 ipv6 address 2001:0DB8:1111:2222::1/64
 ipv6 router isis
 tunnel source GigabitEthernet 0/0/0
 tunnel destination 10.0.0.2
 tunnel mode gre ip
!
interface GigabitEthernet 0/0/0
 ip address 10.0.0.1 255.255.255.0
!
```

```
router isis
 network 49.0000.0000.000a.00
```

Router B

```
ipv6 unicast-routing
clns routing
!
interface Tunnel 0
 no ip address
 ipv6 address 2001:0DB8:1111:2222::2/64
 ipv6 router isis
 tunnel source GigabitEthernet 0/0/0
 tunnel destination 10.0.0.1
 tunnel mode gre ip
!
interface GigabitEthernet 0/0/0
 ip address 10.0.0.2 255.255.255.0
!
router isis
 network 49.0000.0000.000b.00
 address-family ipv6
 redistribute static
 exit-address-family
```

Example: Configuring EoMPLS over GRE

Router A Configuration

```
vrf definition VPN1
 rd 100:1
 address-family ipv4
 route-target both 100:1
 exit-address-family
!
mpls label protocol ldp
mpls ldp neighbor 209.165.200.224 targeted
mpls ldp router-id Loopback0 force
!
interface tunnel 0
 ip address 209.165.200.225 255.255.255.224
 mpls label protocol ldp
 mpls ip
 keepalive 10 3
 tunnel source TenGigabitEthernet 2/1/0
 tunnel destination 209.165.200.226
!
interface Loopback 0
 ip address 209.165.200.230 255.255.255.224
!
interface TenGigabitEthernet 2/1/0
 mtu 9216
 ip address 209.165.200.235 255.255.255.224
!
interface TenGigabitEthernet 9/1
 no ip address
!
interface TenGigabitEthernet 9/1.11
 vrf forwarding VPN1
 encapsulation dot1Q 300
```



```
ip address 209.165.200.237 255.255.255.224
!
interface TenGigabitEthernet 9/2
  mtu 9216
  no ip address
xconnect 209.165.200.239 200 encapsulation mpls
!
router bgp 65000
  bgp log-neighbor-changes
  neighbor 209.165.200.240 remote-as 65000
  neighbor 209.165.200.240 update-source Loopback0
  neighbor 209.165.200.245 remote-as 100
!
address-family vpnv4
  neighbor 209.165.200.240 activate
  neighbor 209.165.200.240 send-community extended
!
address-family ipv4 vrf VPN1
  no synchronization
  neighbor 209.165.200.247 remote-as 100
  neighbor 209.165.200.248 activate
  neighbor 209.165.200.249 send-community extended
!
ip route 209.165.200.251 255.255.255.224 tunnel 0
ip route 209.165.200.254 255.255.255.224 209.165.200.256
Router B Configuration
vrf definition VPN1
  rd 100:1
  address-family ipv4
  route-target both 100:1
exit-address-family
!
mpls ldp neighbor 209.165.200.229 targeted
mpls label protocol ldp
mpls ldp router-id Loopback0 force
!
interface tunnel 0
  ip address 209.165.200.230 255.255.255.224
  mpls label protocol ldp
  mpls ip
  keepalive 10 3
  tunnel source TenGigabitEthernet 3/3/0
  tunnel destination 209.165.200.232
!
interface Loopback 0
  ip address 209.165.200.234 255.255.255.224
!
interface TenGigabitEthernet 2/1/1
  mtu 9216
  no ip address
  xconnect 209.165.200.237 200 encapsulation mpls
!
interface TenGigabitEthernet 2/3/1
  mtu 9216
  no ip address
!
interface TenGigabitEthernet 2/3.11/1
  vrf forwarding VPN1
  encapsulation dot1Q 300
  ip address 209.165.200.239 255.255.255.224
!
interface TenGigabitEthernet 3/3/0
  mtu 9216
  ip address 209.165.200.240 255.255.255.224
```

```

!
router bgp 65000
  bgp log-neighbor-changes
  neighbor 209.165.200.241 remote-as 65000
  neighbor 209.165.200.241 update-source Loopback0
  neighbor 209.165.200.244 remote-as 200
  !
  address-family vpnv4
    neighbor 209.165.200.241 activate
    neighbor 209.165.200.241 send-community extended
  exit-address-family
  !
  address-family ipv4 vrf VPN1
    no synchronization
    neighbor 209.165.200.246 remote-as 200
    neighbor 209.165.200.246 activate
    neighbor 209.165.200.246 send-community extended
  exit-address-family
!
i
ip route 209.165.200.226 255.255.255.224 tunnel 0
ip route 209.165.200.229 255.255.255.224 209.165.200.235

```

Configuring QoS Options on Tunnel Interfaces Examples

The following sample configuration applies GTS directly on the tunnel interface. In this example, the configuration shapes the tunnel interface to an overall output rate of 500 kb/s.

```

interface Tunnel 0
  ip address 10.1.2.1 255.255.255.0
  traffic-shape rate 500000 125000 125000 1000
  tunnel source 10.1.1.1
  tunnel destination 10.2.2.2

```

The following sample configuration shows how to apply the same shaping policy to the tunnel interface with the MQC commands:

```

policy-map tunnel
  class class-default
    shape average 500000 125000 125000
  !
interface Tunnel 0
  ip address 10.1.2.1 255.255.255.0
  service-policy output tunnel
  tunnel source 10.1.35.1
  tunnel destination 10.1.35.2

```

Policing Example

When an interface becomes congested and packets start to queue, you can apply a queueing method to packets that are waiting to be transmitted. Logical interfaces--tunnel interfaces in this example--do not inherently support a state of congestion and do not support the direct application of a service policy that applies a queueing method. Instead, you must apply a hierarchical policy. Create a "child" or lower-level policy that configures a queueing mechanism, such as low-latency queueing, with the **priority** command and CBWFQ with the **bandwidth** command.

```

policy-map child
  class voice
    priority 512

```

Create a "parent" or top-level policy that applies class-based shaping. Apply the child policy as a command under the parent policy because admission control for the child class is done according to the shaping rate for the parent class.

```
policy-map tunnel
  class class-default
  shape average 2000000
  service-policy child
```

Apply the parent policy to the tunnel interface.

```
interface tunnel 0
  service-policy tunnel
```

In the following example, a tunnel interface is configured with a service policy that applies queueing without shaping. A log message is displayed noting that this configuration is not supported.

```
Router(config)# interface tunnel1
Router(config-if)# service-policy output child
Class Based Weighted Fair Queueing not supported on this interface
```

Additional References

The following sections provide references related to implementing tunnels.

Related Documents

Related Topic	Document Title
All Cisco IOS XE commands	Cisco IOS Master Command List, All Releases
Tunnel commands: complete command syntax, command mode, defaults, command history, usage guidelines, and examples	<i>Cisco IOS Interface and Hardware Component Command Reference</i>
IPv6 commands: complete command syntax, command mode, defaults, command history, usage guidelines, and examples	<i>Cisco IOS IPv6 Command Reference</i>
Cisco IOS XE Interface and Hardware Component configuration modules	<i>Cisco IOS XE Interface and Hardware Component Configuration Guide, Release 2</i>
Cisco IOS XE IPv6 configuration modules	<i>Cisco IOS XE IPv6 Configuration Guide, Release 2</i>
Cisco IOS XE Quality of Service Solutions configuration modules	<i>Cisco IOS XE Quality of Service Solutions Configuration Guide</i>
Cisco IOS XE Multiprotocol Label Switching configuration modules	<i>Cisco IOS XE Multiprotocol Label Switching Configuration Guide</i>
Configuration example for a VRF-aware dynamic multipoint VPN (DMVPN)	"Dynamic Multipoint VPN (DMVPN)" configuration module in the <i>Cisco IOS XE Security Configuration Guide: Secure Connectivity</i>

Standards/RFCs

Standard	Title
No new or modified standards are supported, and support for existing standards has not been modified.	--
RFC 791	<i>Internet Protocol</i>
RFC 1191	<i>Path MTU Discovery</i>
RFC 1323	<i>TCP Extensions for High Performance</i>
RFC 1483	<i>Multiprotocol Encapsulation over ATM Adaptation Layer 5</i>
RFC 2003	<i>IP Encapsulation Within IP</i>
RFC 2018	<i>TCP Selective Acknowledgment Options</i>
RFC 2460	<i>Internet Protocol, Version 6 (IPv6)</i>
RFC 2473	<i>Generic Packet Tunneling in IPv6 Specification</i>
RFC 2474	<i>Differentiated Services Field (DS Field) in the IPv4 and IPv6 Headers</i>
RFC 2516	<i>A Method for Transmitting PPP over Ethernet (PPPoE)</i>
RFC 2547	<i>BGP/MPLS VPNs</i>
RFC 2780	<i>IANA Allocation Guidelines for Values in the Internet Protocol and Related Headers</i>
RFC 2784	<i>Generic Routing Encapsulation (GRE)</i>
RFC 2890	<i>Key and Sequence Number Extensions to GRE</i>
RFC 2893	<i>Transition Mechanisms for IPv6 Hosts and Routers</i>
RFC 3056	<i>Connection of IPv6 Domains via IPv4 Clouds</i>
RFC 3147	<i>Generic Routing Encapsulation over CLNS Networks</i>

Technical Assistance

Description	Link
The Cisco Support and Documentation website provides online resources to download documentation, software, and tools. Use these resources to install and configure the software and to troubleshoot and resolve technical issues with Cisco products and technologies. Access to most tools on the Cisco Support and Documentation website requires a Cisco.com user ID and password.	http://www.cisco.com/cisco/web/support/index.html

Feature Information for Implementing Tunnels

The following table provides release information about the feature or features described in this module. This table lists only the software release that introduced support for a given feature in a given software release train. Unless noted otherwise, subsequent releases of that software release train also support that feature.

Use Cisco Feature Navigator to find information about platform support and Cisco software image support. To access Cisco Feature Navigator, go to www.cisco.com/go/cfn. An account on Cisco.com is not required.

Table 7: Feature Information for Implementing Tunnels

Feature Name	Releases	Feature Information
EoMPLS over GRE	Cisco IOS XE Release 2.5	The EoMPLS over GRE feature allows you to tunnel Layer 2 traffic through a Layer 3 MPLS network. This feature also helps to create the GRE tunnel as hardware-based switched, and with high performance that encapsulates EoMPLS frames within the GRE tunnel. No new commands were introduced or modified by this feature.
GRE Tunnel IP Source and Destination VRF Membership	Cisco IOS XE Release 2.2	The GRE Tunnel IP Source and Destination VRF Membership feature allows you to configure the source and destination of a tunnel to belong to any VPN VRF table. The following command was introduced or modified: tunnel vrf .
GRE Tunnel Keepalive	Cisco IOS XE Release 2.1	The GRE Tunnel Keepalive feature provides the capability of configuring keepalive packets to be sent over IP-encapsulated GRE tunnels. You can specify the rate at which keepalives will be sent and the number of times that a device will continue to send keepalive packets without a response before the interface becomes inactive. GRE keepalive packets may be sent from both sides of a tunnel or from just one side. The following command was introduced by this feature: keepalive (tunnel interfaces) .
IP over IPv6 Tunnels	Cisco IOS XE Release 2.4	The following commands were modified by this feature: tunnel destination , tunnel mode , and tunnel source .
IP Precedence for GRE Tunnels	Cisco IOS XE Release 2.1	This feature was introduced on Cisco ASR 1000 Aggregation Services Routers.
IP Tunnel—SSO	Cisco IOS XE Release 3.6	High availability support was added to IP Tunnels. No new commands were introduced or modified by this feature.

Feature Name	Releases	Feature Information
Tunnel ToS	Cisco IOS XE Release 2.1	<p>The Tunnel ToS feature allows you to configure the ToS and Time-to-Live (TTL) byte values in the encapsulating IP header of tunnel packets for an IP tunnel interface on a router. The Tunnel ToS feature is supported in Cisco Express Forwarding, fast switching, and process switching forwarding modes.</p> <p>The following commands were introduced or modified by this feature: show interfaces tunnel, tunnel tos, tunnel, and ttl.</p>



CHAPTER 8

Tunnel Route Selection

The Tunnel Route Selection feature allows the tunnel transport to be routed using a subset of the routing table. When there are equal-cost routes to a tunnel destination, normal tunnel transport behavior is to use one of the available routes chosen at random. The Tunnel Route Selection feature allows the explicit configuration of the outgoing interface for the tunnel transport.

- [Finding Feature Information, on page 73](#)
- [Prerequisites for Tunnel Route Selection, on page 73](#)
- [Restrictions for Tunnel Route Selection, on page 73](#)
- [Information About Tunnel Route Selection, on page 74](#)
- [How to Configure Tunnel Route Selection, on page 75](#)
- [Configuration Examples for Tunnel Route Selection, on page 76](#)
- [Additional References, on page 77](#)
- [Feature Information for Tunnel Route Selection, on page 77](#)

Finding Feature Information

Your software release may not support all the features documented in this module. For the latest caveats and feature information, see [Bug Search Tool](#) and the release notes for your platform and software release. To find information about the features documented in this module, and to see a list of the releases in which each feature is supported, see the feature information table at the end of this module.

Use Cisco Feature Navigator to find information about platform support and Cisco software image support. To access Cisco Feature Navigator, go to www.cisco.com/go/cfn. An account on Cisco.com is not required.

Prerequisites for Tunnel Route Selection

Tunnel interfaces are configured.

Restrictions for Tunnel Route Selection

This feature is supported in the following tunnel modes only:

- Generic Routing Encapsulation (GRE) IP

- GRE Multipoint
- IP in IP
- Mobile User Datagram Protocol (UDP)

This feature is not supported on a tunnel when the tunnel transport is a GRE Multipoint tunnel.

Supported Configuration

```
interface tunnel 0
  tunnel mode gre multipoint
  tunnel route-via tunnel 1
interface tunnel 1
  tunnel mode gre ip
```

Unsupported Configuration

```
interface tunnel 0
  tunnel mode gre multipoint
  tunnel route-via tunnel 1
interface tunnel 1
  tunnel mode gre multipoint
```

Information About Tunnel Route Selection

Tunnel Transport Behavior

The Tunnel Route Selection feature allows the tunnel transport to be routed using a subset of the routing table by specifying the outgoing interface of the tunnel transport.

The Tunnel Route Selection feature is not the same as an implementation of policy-based routing for the tunnel transport. The Tunnel Route Selection feature will forward traffic using only a subset of the route table, and it cannot introduce routing loops into the network.

The figure below compares default tunnel behavior with the Tunnel Route Selection behavior.

Figure 3: Tunnel Route Selection Traffic

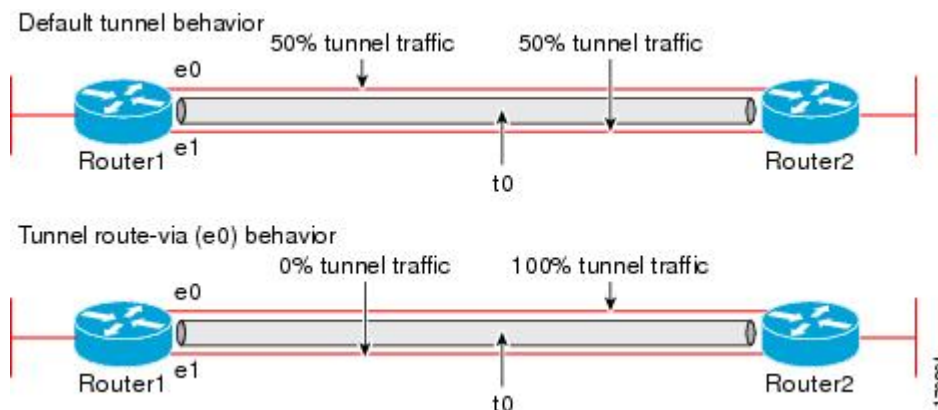

How to Configure Tunnel Route Selection

Configuring Tunnel Route Selection

Perform the following steps to specify the outgoing interface of the tunnel transport to route the tunnel transport using a subset of the routing table.

SUMMARY STEPS

1. **enable**
2. **configure terminal**
3. **interface tunnel** *interface-number*
4. **tunnel route-via** *interface-type interface-number* {**mandatory** | **preferred**}
5. **end**

DETAILED STEPS

	Command or Action	Purpose
Step 1	enable Example: Router> enable	Enables privileged EXEC mode. • Enter your password if prompted.
Step 2	configure terminal Example: Router# configure terminal	Enters global configuration mode.
Step 3	interface tunnel <i>interface-number</i> Example: Router(config)# interface tunnel 0	Configures a tunnel interface and enters interface configuration mode.
Step 4	tunnel route-via <i>interface-type interface-number</i> { mandatory preferred } Example: Router(config-if)# tunnel route-via ethernet0 mandatory	Specifies the outgoing interface to be used by the tunnel transport.
Step 5	end Example: Router(config-if)# end	Returns to privileged EXEC mode.

Troubleshooting Tips

To troubleshoot your configuration, use the **debug tunnel route-via** command in privileged EXEC mode. The following is sample output from the **debug tunnel route-via** command after the **tunnel route-via** command was used to route the tunnel transport explicitly using a subset of the routing table.

```
Router# debug tunnel route-via
Tunnel route-via debugging is on
Router#
*May 23 08:40:53.707: TUN-VIA: Tunnel0 candidate route-via Ethernet0/0, next hop 10.73.2.1
*May 23 08:40:53.707: TUN-VIA: Tunnel0 route-via action is forward
*May 23 08:41:03.719: TUN-VIA: Tunnel0 candidate route-via Ethernet0/0, next hop 10.73.2.1
*May 23 08:41:03.719: TUN-VIA: Tunnel0 route-via action is forward
Router# undebg tunnel route-via
Tunnel route-via debugging is off
```

What to Do Next

You can verify the tunnel route selection configuration. To verify your configuration, use the **show interfaces tunnel** command in privileged EXEC mode. The following example shows that the tunnel transport is routed using a subset of the routing table by specifying the outgoing interface of the tunnel transport.

```
Router# show running-config interface tunnel 0
Building configuration...
Current configuration : 147 bytes
!
interface Tunnel0
 ip unnumbered Loopback0
 tunnel source Loopback0
 tunnel destination 10.73.0.102
 tunnel route-via Ethernet0 preferred
end
Router# show interfaces tunnel 0 | include route-via
Tunnel route-via feature is on [Ethernet0, preferred]
```

Configuration Examples for Tunnel Route Selection

Example Configuring Tunnel Route Selection

The following example shows Tunnel 0 configured to use Ethernet interface 0 as its preferred outgoing transport interface. Traffic that exits the router using the tunnel 0 interface will be sent out of Ethernet interface 0 if there is a route to the tunnel destination out of Ethernet interface 0. If there is no route out of Ethernet interface 0, the traffic will be forwarded as if the Tunnel Route Selection feature were not configured.

If the **tunnel route-via interface-type interface-number mandatory** command is configured, and there is no route to the tunnel destination using that interface, a point-to-point tunnel interface will go into a down state.

```
Router> enable
Router# configure terminal
Enter configuration commands, one per line. End with CNTL/Z.
Router(config)# interface tunnel 0
Router(config-if)# tunnel route-via ethernet0 preferred
```

```

Router(config-if)# end
Router# show running-config interface tunnel 0
Building configuration...
Current configuration : 147 bytes
!
interface Tunnel0
 ip unnumbered Loopback0
 tunnel source Loopback0
 tunnel destination 10.73.0.102
 tunnel route-via Ethernet0 preferred
end

```

Additional References

Related Documents

Related Topic	Document Title
Cisco IOS commands	Cisco IOS Master Command List, All Releases
Interface commands	Cisco IOS Interface and Hardware Component Command Reference
Configuration commands	Cisco IOS Configuration Fundamentals Command Reference

Technical Assistance

Description	Link
The Cisco Support and Documentation website provides online resources to download documentation, software, and tools. Use these resources to install and configure the software and to troubleshoot and resolve technical issues with Cisco products and technologies. Access to most tools on the Cisco Support and Documentation website requires a Cisco.com user ID and password.	http://www.cisco.com/cisco/web/support/index.html

Feature Information for Tunnel Route Selection

The following table provides release information about the feature or features described in this module. This table lists only the software release that introduced support for a given feature in a given software release train. Unless noted otherwise, subsequent releases of that software release train also support that feature.

Use Cisco Feature Navigator to find information about platform support and Cisco software image support. To access Cisco Feature Navigator, go to www.cisco.com/go/cfn. An account on Cisco.com is not required.

Table 8: Feature Information for Tunnel Route Selection

Feature Name	Releases	Feature Information
Tunnel Route Selection	12.4(11)T 15.0(1)M Cisco IOS Release 3.9S	<p>The Tunnel Route Selection feature allows the tunnel transport to be routed using a subset of the routing table. When there are equal-cost routes to a tunnel destination, normal tunnel transport behavior is to use one of the available routes chosen at random. The Tunnel Route Selection feature allows the explicit configuration of the outgoing interface for the tunnel transport.</p> <p>The following commands were introduced or modified: debug tunnel route-via, tunnel route-via, show interfaces tunnel.</p>



CHAPTER 9

MPLS VPN over mGRE

The MPLS VPN over mGRE feature overcomes the requirement that a carrier support multiprotocol label switching (MPLS) by allowing you to provide MPLS connectivity between networks that are connected by IP-only networks. This allows MPLS label switched paths (LSPs) to use generic routing encapsulation (GRE) tunnels to cross routing areas, autonomous systems, and internet service providers (ISPs). When MPLS VPNs are configured over multipoint GRE (mGRE) you can deploy layer-3 (L3) provider edge (PE) based virtual private network (VPN) services using a standards-based IP core. This allows you to provision the VPN services without using the overlay method.

- [Finding Feature Information, on page 79](#)
- [Prerequisites for MPLS VPN over mGRE, on page 79](#)
- [Restrictions for MPLS VPN over mGRE, on page 80](#)
- [Information About MPLS VPN over mGRE, on page 80](#)
- [How to Configure MPLS VPN over mGRE, on page 82](#)
- [Configuration Examples for MPLS VPN over mGRE, on page 88](#)
- [Additional References, on page 90](#)
- [Feature Information for MPLS VPN over mGRE, on page 91](#)

Finding Feature Information

Your software release may not support all the features documented in this module. For the latest caveats and feature information, see [Bug Search Tool](#) and the release notes for your platform and software release. To find information about the features documented in this module, and to see a list of the releases in which each feature is supported, see the feature information table.

Use Cisco Feature Navigator to find information about platform support and Cisco software image support. To access Cisco Feature Navigator, go to www.cisco.com/go/cfn. An account on Cisco.com is not required.

Prerequisites for MPLS VPN over mGRE

Before you configure MPLS VPN with mGRE tunnels, ensure that the MPLS VPN is configured and working properly. See the "Configuring MPLS Layer 3 VPNs" module for information about setting up MPLS VPNs.

Restrictions for MPLS VPN over mGRE

- Tunnelled tag traffic must enter the router through a line card that supports MPLS VPN over mGRE.
- Each PE router supports one tunnel configuration only.
- MPLS VPN over mGRE feature does not support transportation of multicast traffic between VPNs, however mVPN over Rosen based mGRE can co-exist with MPLS VPN over mGRE feature to provide solution for multicast VPN.
- When a GRE tunnel has the same destination address and source address as the mGRE, the tunnel gets route-cache switched.
- The packets that require fragmentation get route cache-switched.
- When an L3VPN profile is removed and added back, then you should clear the Border Gateway Protocol (BGP) using the **clear ip bgp soft** command.
- When an mGRE tunnel is created, a dummy tunnel is also created.
- The loopback or IP address used in the update source of the BGP configuration should be the same as that of the transport source of the L3VPN profile.
- mGRE is not stateful switchover (SSO) compliant. However, both mGRE and SSO coexist.
- You can configure mGRE and multicast distribution tree (MDT) tunnels with the same loopback address.

The limitations for MPLS VPN over mGRE feature are as follows:

- Not all GRE options are supported in the hardware (for example, GRE extended header and GRE key).
- Checking identical VLANs (Internet Control Message Protocol [ICMP] redirect) is not supported on the tunnels.
- Features such as unicast reverse path forwarding (uRPF) and BGP policy accounting are not supported on the tunnels.

Information About MPLS VPN over mGRE

You can configure mGRE tunnels to create a multipoint tunnel network that overlays an IP backbone. This overlay connects PE routers to transport VPN traffic.

In addition, when MPLS VPNs are configured over mGRE you can deploy L3 PE-based VPN services using a standards-based IP core. This allows you to provision the VPN services without using the overlay method. When MPLS VPN over mGRE is configured, the system uses IPv4-based mGRE tunnels to encapsulate VPN-labeled IPv4 and IPv6 packets between PEs. To deploy MPLS VPN over mGRE tunnels, you create a VRF instance, enable and configure L3 VPN encapsulation, link the route map to the application template, and set up the BGP VPNv4 and VPNv6 exchange so that updates are filtered through the route map.

MPLS VPN over mGRE

GRE is a point-to-point tunneling protocol where two peers form the endpoints of the tunnel. It is designed to encapsulate network-layer packets inside IP tunneling packets. mGRE is a similar protocol with a single endpoint at one side of the tunnel connected to multiple endpoints at the other side of the tunnel. The mGRE tunnel provides a common link between branch offices that connect to the same VPN. Because mGRE is a point-to-multipoint model, fully meshed GRE tunnels are not required to interconnect MPLS VPN PE devices.

MPLS is a widely deployed VPN internet architecture. MPLS requires that all core routers in the network support MPLS. This feature is useful in networks where the service provider uses a backbone carrier to provide connectivity.

The MPLS VPN over mGRE feature overcomes the requirement of carrier support MPLS by allowing you to provide MPLS connectivity between networks that are connected by IP-only networks. This allows MPLS LSPs to use GRE tunnels to cross routing areas, autonomous systems, and ISPs.

When MPLS VPNs are configured over mGRE you can deploy L3 PE-based VPN services using a standards-based IP core. This allows you to provision the VPN services without using LSP or a Label Distribution Protocol (LDP). The system uses IPv4-based mGRE tunnels to encapsulate VPN-labeled IPv4 and IPv6 packets between PEs.

The MPLS VPN over mGRE feature also allows you to deploy existing MPLS VPN LSP-encapsulated technology concurrently with MPLS VPN over mGRE and enables the system to determine which encapsulation method is used to route specific traffic. The ingress PE router determines which encapsulation technology to use when a packet is sent to the remote PE router.

This section includes information on the following topics on MPLS VPN over mGRE feature:

Route Maps

By default, VPN traffic is sent using an LSP. The MPLS VPN over mGRE feature uses user-defined route maps to determine which VPN prefixes are reachable over an mGRE tunnel and which VPN prefixes are reachable using an LSP. The route map is applied to advertisements for VPNv4 and VPNv6 address families. The route map uses a next hop tunnel table to determine the encapsulation method for the VPN traffic.

To route traffic over the mGRE tunnel, the system creates an alternative address space that shows that all next hops are reached by encapsulating the traffic in an mGRE tunnel. To configure a specific route to use an mGRE tunnel, the user adds an entry for that route to the route map. The new entry remaps the Network Layer Reachability Information (NLRI) of the route to the alternative address space. If there is no remap entry in the route map for a route, then traffic on that route is forwarded over an LSP.

When the user configures MPLS VPN over mGRE, the system automatically provisions the alternative address space, normally held in the tunnel-encapsulated virtual routing and forwarding (VRF) instance. To ensure that all traffic reachable through the address space is encapsulated in an mGRE tunnel, the system installs a single default route out of a tunnel. The system also creates a default tunnel on the route map. The user can attach this default route map to the appropriate BGP updates.

Tunnel Endpoint Discovery and Forwarding

In order for the MPLS VPN over mGRE feature to function correctly, the system must be able to discover the remote PEs in the system and construct tunnel forwarding information for these remote PEs. In addition the system must be able to detect when a remote PE is no longer valid and remove the tunnel forwarding information for that PE.

If an ingress PE receives a VPN advertisement over BGP, it uses the route target attributes (which it inserts into the VRF) and the MPLS VPN label from the advertisement, to associate the prefixes with the appropriate customer. The next hop of the inserted route is set to the NLRI of the advertisement.

The advertised prefixes contain information about remote PEs in the system (in the form of NLRIs), and the PE uses this information to notify the system when an NLRI becomes active or inactive. The system uses this notification to update the PE forwarding information.

When the system receives notification of a new remote PE, it adds the information to the tunnel endpoint database, which causes the system to create an adjacency associated with the tunnel interface. The adjacency description includes information on the encapsulation and other processing that the system must perform to send encapsulated packets to the new remote PE.

The adjacency information is placed into the tunnel encapsulated VRF. When a user remaps a VPN NLRI to a route in the VRF (using the route map), the system links the NLRI to the adjacency; therefore the VPN is linked to a tunnel.

Tunnel Decapsulation

When the egress PE receives a packet from a tunnel interface that uses the MPLS VPN over mGRE feature, the PE decapsulates the packet to create a VPN label tagged packet, and sends the packet to the MPLS forwarding (MFI) code.

Tunnel Source

The MPLS VPN over mGRE feature uses a single tunnel configured as an mGRE tunnel to configure a system with a large number of endpoints (remote PEs). To identify the origin of tunnel-encapsulated packets, the system uses the tunnel source information.

At the transmitting (ingress) PE, when a VPN packet is sent to a tunnel, the tunnel destination is the NLRI. At a receiving (egress) PE, the tunnel source is the address that the packets encapsulated in the mGRE tunnel are received on. Therefore, at the egress PE the packet destination must match the NLRI from the local PE.

IPv6 VPN

If the advertising PE router has an IPv6 address then the NLRI must also be an IPv6 address (regardless of the network between the PEs). If the network between the PEs is IPv4 based, the system creates the IPv6 address of the advertising PE using an IPv4 mapped address in the following form: ::FFFF:IPv4-PE-address. The receiving PE sets the next hop for the VPN tag IPv6 prefixes to the IPv4 address embedded in the IPv6 NLRI. This enables the PE to link VPNv6 traffic to an LSP or an mGRE tunnel in the same way it maps VPNv4 traffic.

When a PE receives VPNv6 updates, it applies the IPv6 route map. The MPLS VPN over mGRE feature uses the IPv6 route map to set the next hop information in the Tunnel_Encap VRF.

How to Configure MPLS VPN over mGRE

Configuring an L3VPN Encapsulation Profile

This section describes how to configure an L3VPN encapsulation profile.



Note Transport protocols such as IPv6, MPLS, IP, and Layer 2 Tunneling Protocol version 3 (L2TPv3) can also be used in this configuration.

SUMMARY STEPS

1. **enable**
2. **configure terminal**
3. **l3vpn encapsulation ip** *profile-name*
4. **transport ipv4** [**source** *interface-type interface-number*]
5. **protocol gre** [**key** *gre-key*]
6. **end**
7. **show l3vpn encapsulation ip** *profile-name*

DETAILED STEPS

	Command or Action	Purpose
Step 1	enable Example: <pre>Router> enable</pre>	Enables privileged EXEC mode. <ul style="list-style-type: none"> • Enter your password if prompted.
Step 2	configure terminal Example: <pre>Router# configure terminal</pre>	Enters global configuration mode.
Step 3	l3vpn encapsulation ip <i>profile-name</i> Example: <pre>Router(config)# l3vpn encapsulation ip tunnel encap</pre>	Enters L3 VPN encapsulation configuration mode to create the tunnel.
Step 4	transport ipv4 [source <i>interface-type interface-number</i>] Example: <pre>Router(config-l3vpn-encap-ip)# transport ipv4 source loopback 0</pre>	(Optional) Specifies IPv4 transport source mode and defines the transport source interface. <ul style="list-style-type: none"> • If you use the transport ipv4 source <i>interface-type interface-number</i> command, make sure that the specified source address is used as the next hop in BGP updates advertised by the PE. • If you do not use this command, the bgp update source or bgp next-hop command is automatically used as the tunnel source.
Step 5	protocol gre [key <i>gre-key</i>] Example:	Specifies GRE as the tunnel mode and sets the GRE key.

	Command or Action	Purpose
	Router(config-l3vpn-encap-ip)# protocol gre key 1234	
Step 6	end Example: Router(config-l3vpn-encap-ip)# end	Exits L3 VPN encapsulation configuration mode and returns to privileged EXEC mode.
Step 7	show l3vpn encapsulation ip <i>profile-name</i> Example: Router# show l3vpn encapsulation ip tunnel encap	(Optional) Displays the profile health and the underlying tunnel interface.

Configuring BGP and Route Maps

Perform this task to configure BGP and route maps. The following steps also enable you to link the route map to the application template and set up the BGP VPNv4 and VPNv6 exchange so that the updates are filtered through the route map.

SUMMARY STEPS

1. **enable**
2. **configure terminal**
3. **router bgp *as-number***
4. **bgp log-neighbor-changes**
5. **neighbor *ip-address* remote-as *as-number***
6. **neighbor *ip-address* update-source *interface name***
7. **address-family ipv4**
8. **no synchronization**
9. **redistribute connected**
10. **neighbor *ip-address* activate**
11. **no auto-summary**
12. **exit**
13. **address-family vpnv4**
14. **neighbor *ip-address* activate**
15. **neighbor *ip-address* send-community both**
16. **neighbor *ip-address* route-map *map-name* in**
17. **exit**
18. **address-family vpnv6**
19. **neighbor *ip-address* activate**
20. **neighbor *ip-address* send-community both**
21. **neighbor *ip-address* route-map *map-name* in**
22. **exit**
23. **route-map *map-tag* permit *position***

24. `set ip next-hop encapsulate l3vpn profile-name`
25. `set ipv6 next-hop encapsulate l3vpn profile-name`
26. `exit`
27. `exit`

DETAILED STEPS

	Command or Action	Purpose
Step 1	enable Example: <pre>Router> enable</pre>	Enables privileged EXEC mode. <ul style="list-style-type: none"> • Enter your password if prompted.
Step 2	configure terminal Example: <pre>Router# configure terminal</pre>	Enters global configuration mode.
Step 3	router bgp as-number Example: <pre>Router(config)# router bgp 100</pre>	Specifies the number of an autonomous system that identifies the router to other BGP routers and tags the routing information passed along, and enters router configuration mode.
Step 4	bgp log-neighbor-changes Example: <pre>Router(config-router)# bgp log-neighbor-changes</pre>	Enables logging of BGP neighbor resets.
Step 5	neighbor ip-address remote-as as-number Example: <pre>Router(config-router)# neighbor 209.165.200.225 remote-as 100</pre>	Adds an entry to the BGP or multiprotocol BGP neighbor table.
Step 6	neighbor ip-address update-source interface name Example: <pre>Router(config-router)# neighbor 209.165.200.225 update-source loopback 0</pre>	Allows BGP sessions to use any operational interface for TCP connections.
Step 7	address-family ipv4 Example: <pre>Router(config-router)# address-family ipv4</pre>	Enters address family configuration mode to configure routing sessions that use IPv4 address prefixes.
Step 8	no synchronization Example: <pre>Router(config-router-af)# no synchronization</pre>	Enables the Cisco software to advertise a network route without waiting for an IGP.

	Command or Action	Purpose
Step 9	redistribute connected Example: <pre>Router(config-router-af)# redistribute connected</pre>	Redistributes routes from one routing domain into another routing domain and allows the target protocol to redistribute routes learned by the source protocol and connected prefixes on those interfaces over which the source protocol is running.
Step 10	neighbor ip-address activate Example: <pre>Router(config-router-af)# neighbor 209.165.200.225 activate</pre>	Enables the exchange of information with a BGP neighbor.
Step 11	no auto-summary Example: <pre>Router(config-router-af)# no auto-summary</pre>	Disables automatic summarization and sends subprefix routing information across classful network boundaries.
Step 12	exit Example: <pre>Router(config-router-af)# exit</pre>	Exits address family configuration mode.
Step 13	address-family vpnv4 Example: <pre>Router(config-router)# address-family vpnv4</pre>	Enters address family configuration mode to configure routing sessions, such as BGP, that use standard VPNv4 address prefixes.
Step 14	neighbor ip-address activate Example: <pre>Router(config-router-af)# neighbor 209.165.200.225 activate</pre>	Enables the exchange of information with a BGP neighbor.
Step 15	neighbor ip-address send-community both Example: <pre>Router(config-router-af)# neighbor 209.165.200.225 send-community both</pre>	Specifies that a communities attribute, for both standard and extended communities, should be sent to a BGP neighbor.
Step 16	neighbor ip-address route-map map-name in Example: <pre>Router(config-router-af)# neighbor 209.165.200.225 route-map SELECT_UPDATE_FOR_L3VPN in</pre>	Applies the named route map to the incoming route.
Step 17	exit Example:	Exits address family configuration mode.

	Command or Action	Purpose
	<code>Router(config-router-af)# exit</code>	
Step 18	address-family vpnv6 Example: <code>Router(config-router)# address-family vpnv6</code>	Enters address family configuration mode to configure routing sessions, such as BGP, that use VPNv6 address prefixes.
Step 19	neighbor ip-address activate Example: <code>Router(config-router-af)# neighbor 209.165.200.252 activate</code>	Enables the exchange of information with a BGP neighbor.
Step 20	neighbor ip-address send-community both Example: <code>Router(config-router-af)# neighbor 209.165.200.252 send-community both</code>	Specifies that a communities attribute, for both standard and extended communities, should be sent to a BGP neighbor.
Step 21	neighbor ip-address route-map map-name in Example: <code>Router(config-router-af)# neighbor 209.165.200.252 route-map SELECT_UPDATE_FOR_L3VPN in</code>	Applies the named route map to the incoming route.
Step 22	exit Example: <code>Router(config-router-af)# exit</code>	Exits address family configuration mode.
Step 23	route-map map-tag permit position Example: <code>Router(config-router)# route-map SELECT_UPDATE_FOR_L3VPN permit 10</code>	<p>Enters route-map configuration mode and defines the conditions for redistributing routes from one routing protocol into another.</p> <ul style="list-style-type: none"> • The redistribute router configuration command uses the specified map tag to reference this route map. Multiple route maps may share the same map tag name. • If the match criteria are met for this route map, the route is redistributed as controlled by the set actions. • If the match criteria are not met, the next route map with the same map tag is tested. If a route passes none of the match criteria for the set of route maps sharing the same name, it is not redistributed by that set. • The <i>position</i> argument indicates the position a new route map will have in the list of route maps already configured with the same name.

	Command or Action	Purpose
Step 24	set ip next-hop encapsulate l3vpn <i>profile-name</i> Example: <pre>Router(config-route-map)# set ip next-hop encapsulate l3vpn my profile</pre>	Indicates that output IPv4 packets that pass a match clause of the route map are sent to the VRF for tunnel encapsulation.
Step 25	set ipv6 next-hop encapsulate l3vpn <i>profile-name</i> Example: <pre>Router(config-route-map)# set ip next-hop encapsulate l3vpn tunnel encap</pre>	Indicates that output IPv6 packets that pass a match clause of the route map are sent to the VRF for tunnel encapsulation.
Step 26	exit Example: <pre>Router(config-route-map)# exit</pre>	Exits route-map configuration mode and enters global configuration mode.
Step 27	exit Example: <pre>Router(config)# exit</pre>	Exits global configuration mode.

Configuration Examples for MPLS VPN over mGRE

Example Verifying the MPLS VPN over mGRE Configuration

Use the following examples to verify that the configuration is working properly:

Cisco Express Forwarding (CEF) Switching

You can verify that CEF switching is working as expected:

```
Router# show ip cef vrf Customer_A tunnel 0

209.165.200.250
/24
  nexthop 209.165.200.251 Tunnel0 label 16
```

Endpoint Creation

You can verify the tunnel endpoint that has been created:

```
Router# show tunnel endpoints tunnel 0

Tunnel0 running in multi-GRE/IP mode
Endpoint transport 209.165.200.251 Refcount 3 Base 0x2AE93F0 Create Time 00:00:42
overlay 209.165.200.254 Refcount 2 Parent 0x2AE93F0 Create Time 00:00:42
```

Adjacency

You can verify that the corresponding adjacency has been created:

```
Router# show adjacency tunnel 0
  Protocol Interface          Address
  IP       Tunnel0           209.165.200.251 (4)
  TAG     Tunnel0           209.165.200.251 (3)
```

Profile Health

You can use **show l3vpn encapsulation profile-name** command to get information on the basic state of the application. The output of this command provides you details on the references to the underlying tunnel.

```
Router# show l3vpn encapsulation ip tunnel encap
Profile: tunnel encap
transport ipv4 source Auto: Loopback0
protocol gre
  Tunnel Tunnel0 Created [OK]
  Tunnel Linestate [OK]
  Tunnel Transport Source (Auto) Loopback0 [OK]
```

Example Configuration Sequence for MPLS VPN over mGRE

This example shows the configuration sequence for MPLS VPN over mGRE:

```
vrf definition Customer A
 rd 100:110
 route-target export 100:1000
 route-target import 100:1000
 !
 address-family ipv4
 exit-address-family
 !
 address-family ipv6
 exit-address-family
 !
 !
 ip cef
 !
 ipv6 unicast-routing
 ipv6 cef
 !
 !
 l3vpn encapsulation ip sample profile name
 transport source loopback 0
 protocol gre key 1234
 !
 !
 interface Loopback0
 ip address 209.165.200.252 255.255.255.224
 ip router isis
 !
 interface Serial2/0
 vrf forwarding Customer A
 ip address 209.165.200.253 255.255.255.224
 ipv6 address 3FFE:1001::/64 eui-64
 no fair-queue
 serial restart-delay 0
 !
```

```

router bgp 100
  bgp log-neighbor-changes
  neighbor 209.165.200.254 remote-as 100
  neighbor 209.165.200.254 update-source Loopback0
  !
  address-family ipv4
    no synchronization
    redistribute connected
    neighbor 209.165.200.254 activate
    no auto-summary
  exit-address-family
  !
  address-family vpv4
    neighbor 209.165.200.254 activate
    neighbor 209.165.200.254 send-community both
    neighbor 209.165.200.254 route-map SELECT_UPDATE_FOR_L3VPN in
  exit-address-family
  !
  address-family vpv6
    neighbor 209.165.200.254 activate
    neighbor 209.165.200.254 send-community both
    neighbor 209.165.200.254 route-map SELECT_UPDATE_FOR_L3VPN in
  exit-address-family
  !
  address-family ipv4 vrf Customer A
    no synchronization
    redistribute connected
  exit-address-family
  !
  address-family ipv6 vrf Customer A
    redistribute connected
    no synchronization
  exit-address-family
  !
  !
  route-map SELECT_UPDATE_FOR_L3VPN permit 10
  set ip next-hop encapsulate sample profile name
  set ipv6 next-hop encapsulate sample profile name

```

Additional References

Related Documents

Related Topic	Document Title
Configuring MPLS Layer 3 VPNs	<i>Cisco IOS XE Multiprotocol Label Switching Configuration Guide</i>
Cisco Express Forwarding	<i>Cisco IOS XE IP Switching Configuration Guide</i>
Generic routing encapsulation	<i>Cisco IOS XE Interface and Hardware Component Configuration Guide</i>

Standards

Standard	Title
None	--

MIBs

MIB	MIBs Link
IETF-PPVPN-MPLS-VPN-MIB	To locate and download MIBs for selected platforms, Cisco software releases, and feature sets, use Cisco MIB Locator found at the following URL: http://www.cisco.com/go/mibs

RFCs

RFC	Title
RFC 2547	<i>BGP/MPLS VPNs</i>
RFC 2784	<i>Generic Routing Encapsulation (GRE)</i>
RFC 2890	<i>Key Sequence Number Extensions to GRE</i>
RFC 4023	Encapsulating MPLS in IP or Generic Routing Encapsulation
RFC 4364	<i>BGP/MPLS IP Virtual Private Networks (VPNs)</i>

Technical Assistance

Description	Link
The Cisco Support and Documentation website provides online resources to download documentation, software, and tools. Use these resources to install and configure the software and to troubleshoot and resolve technical issues with Cisco products and technologies. Access to most tools on the Cisco Support and Documentation website requires a Cisco.com user ID and password.	http://www.cisco.com/cisco/web/support/index.html

Feature Information for MPLS VPN over mGRE

The following table provides release information about the feature or features described in this module. This table lists only the software release that introduced support for a given feature in a given software release train. Unless noted otherwise, subsequent releases of that software release train also support that feature.

Use Cisco Feature Navigator to find information about platform support and Cisco software image support. To access Cisco Feature Navigator, go to www.cisco.com/go/cfn. An account on Cisco.com is not required.

Table 9: Feature Information for MPLS VPN over mGRE

Feature Name	Releases	Feature Information
MPLS VPN over mGRE	Cisco IOS XE Release 3.1S	<p>This feature provides support to carry MPLS Layer 3 VPN traffic over mGRE.</p> <p>The following commands were introduced or modified by this feature: l3vpn encapsulation ip, protocol gre, show l3vpn encapsulation ip, transport ipv4, set ip next-hop, set ipv6 next-hop.</p>



CHAPTER 10

IP Tunnel MIBs

This module contains information about MIBs used with interfaces and hardware components. The IP Tunnel MIB feature provides a generic MIB for managing all IPv4- and IPv6-related tunnels, as outlined in RFC 4087, IP Tunnel MIB. Tunneling provides a way to encapsulate arbitrary packets inside a transport protocol. A number of tunneling mechanisms specified by Internet Engineering Task Force (IETF) are implemented by Cisco for both IPv4 and IPv6 environments. Various MIBs are available for managing tunnels.

- [Finding Feature Information, on page 93](#)
- [Prerequisites for the IP Tunnel MIB, on page 93](#)
- [Restrictions for the IP Tunnel MIB, on page 94](#)
- [Information About the IP Tunnel MIB, on page 94](#)
- [How to Configure SNMP and Use the IP Tunnel MIB, on page 96](#)
- [Additional References, on page 97](#)
- [Feature Information for the Tunnel MIB, on page 98](#)

Finding Feature Information

Your software release may not support all the features documented in this module. For the latest caveats and feature information, see [Bug Search Tool](#) and the release notes for your platform and software release. To find information about the features documented in this module, and to see a list of the releases in which each feature is supported, see the feature information table at the end of this module.

Use Cisco Feature Navigator to find information about platform support and Cisco software image support. To access Cisco Feature Navigator, go to www.cisco.com/go/cfn. An account on Cisco.com is not required.

Prerequisites for the IP Tunnel MIB

Configure Simple Network Management Protocol (SNMP) on the router on which the IP Tunnel MIB feature is to be used. See the [Configuring the Router to Use SNMP, on page 96](#) for more information. For more information on configuring an SNMP server, see the "Configuring SNMP Support" chapter of the Cisco IOS Network Management Configuration Guide.

Restrictions for the IP Tunnel MIB

The IP Tunnel MIB feature supports only tunnels that can be created using the **interface tunnel** command. The IP Tunnel MIB feature does not support Layer 2 Tunnel Protocol (L2TP), Point-to-Point Tunneling Protocol (PPTP), or Multiprotocol Label Switching (MPLS) tunnels.

Information About the IP Tunnel MIB

Benefits of the IP Tunnel MIB

Improved Quality of Networks

Better IP tunnel instrumentation leads to an improvement in the quality of networks and better service delivery. A better quality network allows service providers to deliver a more reliable service.

Increased Reliability

The IP Tunnel MIB allows users of network management systems to set inventory and receive notification about their IP tunnel activity.

The IP Tunnel MIB supports both IPv4 and IPv6 network layers as defined in RFC 3291, and is used to manage IP tunnels implemented in the Cisco IOS software.

The IP Tunnel MIB supports all tunnel types, as well as tunnel creation and destruction capability.

Interoperability with Devices Other Than Cisco Devices

The IP Tunnel MIB works with key network management systems, including those of third-party vendors.

MIB Objects Supported by the IP Tunnel MIB

The following MIB objects are supported by the IP Tunnel MIB feature. For details regarding use of MIB objects, see RFC 4087, IP Tunnel MIB.

Table 10: Objects Supported by the IP Tunnel MIB

MIB Object	Description
tunnelIfEntry	Contains information on a particular configured tunnel. You can use the interface tunnel command to set a value for this object.
tunnelIfEncapsMethod	The encapsulation method used by the tunnel. You can use the tunnel mode command to set a value for this object.
tunnelIfHopLimit	Defines the IPv4 time to live (TTL) or IPv6 hop limit to use in the outer IP header. You can use the tunnel ttl command to set a value for this object.
tunnelIfSecurity	Used by the tunnel to secure the outer IP header. The value ipsec indicates that IPsec is used between the tunnel endpoints for authentication or encryption, or both.

MIB Object	Description
tunnelIfTOS	Used by the tunnel to set the high 6 bits (the differentiated services codepoint) of the IPv4 type of service (ToS) or IPv6 traffic class in the outer IP header. You can use the tunnel tos command to set a value for this object.
tunnelIfFlowLabel	Used to set the IPv6 Flow Label value. This object is supported for tunnels over IPv6. The default value for this object is 0.
tunnelIfAddressType	Shows the type of address in the corresponding tunnelIfLocalInetAddress and tunnelIfRemoteInetAddress objects. This object cannot be configured individually through the command-line interface (CLI).
tunnelIfLocalInetAddress	The address of the local endpoint of the tunnel (that is, the source address used in the outer IP header). If the address is unknown, the value is 0.0.0.0 for IPv4 or :: for IPv6. The address type of this object is given by tunnelIfAddressType. You can use the tunnel source command to set a value for this object.
tunnelIfRemoteInetAddress	The address of the remote endpoint of the tunnel (that is, the destination address used in the outer IP header). If the address is unknown or the tunnel is not a point-to-point link (for example, a 6-to-4 tunnel), the value is 0.0.0.0 for tunnels over IPv4 or :: for tunnels over IPv6. The address type of this object is given by tunnelIfAddressType. You can use the tunnel destination command to set a value for this object.
tunnelIfEncapsLimit	Shows the maximum number of additional encapsulations permitted for packets undergoing encapsulation at this node. A value of -1 indicates that no limit is present (except as result of packet size).
tunnelInetConfigEntry	Contains information on a particular configured tunnel. There will be only one entry for multipoint tunnels and for tunnels that have the remote inet address 0.0.0.0 for IPv4 or :: for IPv6. Only generic routing encapsulation (GRE)/IP and GRE/IPv6 tunnels are created through the MIB.
tunnelInetConfigIfIndex	Shows the value of ifIndex corresponding to the tunnel interface. A value of 0 is not legal in the active state and means that the interface index has not yet been assigned.
tunnelInetConfigStatus	Used to create or delete table entries in the MIB table. You can use the interface tunnel to set a value for this object.
tunnelInetConfigStorageType	Indicates the storage type. Only a nonvolatile storage value is supported.

How to Configure SNMP and Use the IP Tunnel MIB

Configuring the Router to Use SNMP



Note Some of the tasks in this section include examples of the SNMP CLI syntax used to set configuration parameters on the router and to read values from MIB objects on the router. These SNMP CLI syntax examples are taken from a Linux workstation using public domain SNMP tools. The SNMP CLI syntax for your workstation might be different. See the documentation that was provided with your SNMP tools for the correct syntax for your network management workstation.

Before you can use the IP Tunnel MIB feature, you must first configure the router to support SNMP. Perform this task to enable SNMP on the router.

SUMMARY STEPS

1. **enable**
2. **configure terminal**
3. **snmp-server community *string1* ro**
4. **snmp-server community *string2* rw**
5. **end**

DETAILED STEPS

	Command or Action	Purpose
Step 1	enable Example: <pre>Router> enable</pre>	Enables privileged EXEC mode. <ul style="list-style-type: none"> • Enter your password if prompted.
Step 2	configure terminal Example: <pre>Router# configure terminal</pre>	Enters global configuration mode.
Step 3	snmp-server community <i>string1</i> ro Example: <pre>Router(config)# snmp-server community public ro</pre>	Sets up the community access string to permit access to SNMP. <ul style="list-style-type: none"> • The <i>string1</i> argument is a community string that consists of from 1 to 32 alphanumeric characters and functions much like a password, permitting access to the SNMP protocol. Blank spaces are not permitted in the community string. • The ro keyword specifies read-only access. SNMP management stations using this string can retrieve MIB objects.

	Command or Action	Purpose
		<p>Note The SNMP community read-only (RO) string for the examples is public. You should use a more complex string for this value in your configuration.</p>
Step 4	<p>snmp-server community <i>string2</i> rw</p> <p>Example:</p> <pre>Router(config)# snmp-server community private rw</pre>	<p>Sets up the community access string to permit access to SNMP.</p> <ul style="list-style-type: none"> The <i>string2</i> argument is a community string that consists of from 1 to 32 alphanumeric characters and functions much like a password, permitting access to the SNMP protocol. Blank spaces are not permitted in the community string. The rw keyword specifies read-write access. SNMP management stations using this string can retrieve and modify MIB objects. <p>Note The SNMP community read-write (RW) string for the examples is private. You should use a more complex string for this value in your configuration.</p>
Step 5	<p>end</p> <p>Example:</p> <pre>Router(config)# end</pre>	<p>Exits the current configuration mode and returns to privileged EXEC mode.</p>

What to Do Next

To implement the IP Tunnel MIB, you must configure a tunnel. For information on configuring tunnels, see the "Implementing Tunnels" chapter in the Cisco IOS Interface and Hardware Component Configuration Guide.

To debug or troubleshoot any issues related to configuring the IP Tunnel MIB through SNMP, use the debug snmp tunnel-mib command. For information on this command see Cisco IOS Interface and Hardware Component Command Reference.

Additional References

Related Documents

Related Topic	Document Title
SNMP commands, complete command syntax, command reference, command history, defaults, defaults, usage guidelines, and examples	<i>Cisco IOS Network Management Command Reference</i>

Related Topic	Document Title
Configuring SNMP Support	<i>Cisco IOS Network Management Configuration Guide</i>
Implementing tunnels	<i>Cisco IOS Interface and Hardware Component Configuration Guide</i>

Standards

Standard	Title
No new or modified standards are supported by this feature, and support for existing standards has not been modified by this feature.	--

MIBs

MIB	MIBs Link
IP Tunnel MIB	To locate and download MIBs for selected platforms, Cisco IOS releases, and feature sets, use Cisco MIB Locator found at the following URL: http://www.cisco.com/go/mibs

RFCs

RFC	Title
RFC 4087	IP Tunnel MIB

Technical Assistance

Description	Link
The Cisco Support and Documentation website provides online resources to download documentation, software, and tools. Use these resources to install and configure the software and to troubleshoot and resolve technical issues with Cisco products and technologies. Access to most tools on the Cisco Support and Documentation website requires a Cisco.com user ID and password.	http://www.cisco.com/cisco/web/support/index.html

Feature Information for the Tunnel MIB

The following table provides release information about the feature or features described in this module. This table lists only the software release that introduced support for a given feature in a given software release train. Unless noted otherwise, subsequent releases of that software release train also support that feature.

Use Cisco Feature Navigator to find information about platform support and Cisco software image support. To access Cisco Feature Navigator, go to www.cisco.com/go/cfn. An account on Cisco.com is not required.

Table 11: Feature Information for the IP Tunnel MIB

Feature Name	Releases	Feature Information
IP Tunnel MIB	12.2(33)SRB 12.2(1st)SY 12.2(44)SG 12.2(33)SRD 15.0(1)M Cisco IOS XE 3.1.0SG Cisco IOS XE Release 3.9S	The IP Tunnel MIB provides a generic MIB for managing all IPv4- and IPv6-related tunnels, as outlined in RFC 4087 IP Tunnel MIB.



CHAPTER 11

IF-MIBs

This module contains information about MIBs used with interfaces and hardware components. The IF-MIB supports all tables defined in RFC 2863, The Interfaces Group MIB, and the CISCO-IFEXTENSION-MIB. This MIB provides the ability to query the Interfaces MIB objects, and the information returned is restricted to the Virtual Private Network (VPN) routing/forwarding (VRF) instance to which the Simple Network Management Protocol (SNMP) context is mapped. Notification hosts may also be configured with contexts to restrict the notifications that need to be sent to the particular host.

The IF-MIB supports context-aware packet information in VRF environments. VRF environments require that contexts apply to VPNs so that clients can be given selective access to the information stored in the IF-MIB. Clients belonging to a particular VRF can access information about the interface from IF-MIB that belongs only to that VRF. When a client tries to get information from an interface that is associated with a particular context, the client can see the information that belongs to only that context and cannot see information to which it is not entitled.

This document describes the enhancement of the Interfaces Group MIB for subinterfaces and RFC 2233 compliance for Cisco's implementation of the IF-MIB in Cisco IOS software.

- [Finding Feature Information, on page 101](#)
- [Prerequisites for Using the IF-MIB, on page 102](#)
- [Information About the IF-MIB, on page 102](#)
- [How to Enable IETF-Compliant Link Traps for SNMP, on page 103](#)
- [Example to Enable IETF-Compliant Link Traps for SNMP, on page 104](#)
- [How to Configure SNMP and Use the IF-MIB, on page 105](#)
- [Additional References, on page 106](#)
- [Feature Information for IF-MIBs, on page 107](#)

Finding Feature Information

Your software release may not support all the features documented in this module. For the latest caveats and feature information, see [Bug Search Tool](#) and the release notes for your platform and software release. To find information about the features documented in this module, and to see a list of the releases in which each feature is supported, see the feature information table.

Use Cisco Feature Navigator to find information about platform support and Cisco software image support. To access Cisco Feature Navigator, go to www.cisco.com/go/cfn. An account on Cisco.com is not required.

Prerequisites for Using the IF-MIB

To use the Interface Group MIB and Ethernet-like Interface MIB described in this document, you must configure SNMP on your system. It is assumed you will be using Cisco IOS or a network management system (NMS) such as CiscoWorks to monitor the performance of your network. For information on these topics, see the documents listed in the "Related Documents" section or the documentation that came with your network management application.

Information About the IF-MIB

The IF-MIB complies with RFC 2233 and provides SNMP support for subinterfaces. Additionally, you can configure SNMP to use either the existing Cisco implementation of linkUp or linkDown traps or the IF-MIB implementation consistent with IETF standards. Refer to RFC 2233 for information about linkUp and linkDown traps.

Starting with Cisco IOS Release 12.1(2)T/12.0(21)S3, you can configure your router to begin using the new RFC 2233 IETF standards-based implementation by using the **snmp-server trap link ietf** command. This command enables notification support for subinterfaces and is disabled by default to allow you to continue using the earlier Cisco implementation of linkUp/linkDown traps if you so choose.

However, please note that when using the earlier Cisco object definitions, an arbitrary value is used for the *locIfReason* object in linkUp/linkDown traps for subinterfaces, which may give you unintended results. This is because the *locIfReason* object is not defined for subinterfaces in the current Cisco implementation, which uses OLD-CISCO-INTERFACES-MIB.my.

If you do not enable this functionality, the link trap varbind list will consist of {ifIndex, ifDescr, ifType, locIfReason}. After you enable this functionality with the **snmp-server trap link ietf** command, the varbind list will consist of {inIndex, ifAdminStatus, ifOperStatus, ifDescr, ifType}. The *locIfReason* object will also be conditionally included in this list depending on whether meaningful information can be retrieved for that object. A configured subinterface will generate retrievable information. On non-HWIDB interfaces, there will be no defined value for *locIfReason*, so it will be omitted from the trap message.

Other updates to the IF-MIB module have also been made to comply with RFC2233. These changes include the addition of the ifCounterDiscontinuityTime object, and the addition of basic support for ifTableLastChange. Updated Online Insertion and Removal (OIR) drivers are planned in a future release for full ifTableLastChange support.

Benefits of the IF-MIB

Compliance with RFC 2233

The enhancement to the IF-MIB allows Cisco IOS to support RFC 2233. Prior to this release, Cisco IOS supported only RFC 1573.

linkUp/linkDown Trap Generation for Subinterfaces

The enhancement to the IF-MIB allows linkUp and linkDown SNMP traps for subinterfaces to be generated correctly, while permitting unaffected users to continue using the earlier Cisco implementation.

The Context-Aware IF-MIB

The context-aware IF-MIB provides the ability to query the Interfaces MIB objects and the information returned be restricted to the VRF to which the SNMP context is mapped. Notification hosts may also be configured with contexts to restrict the notifications that need to be sent to the particular host.

In a VPN environment, different interfaces belong to different VRF instances. VRF instances can be uniquely associated with SNMP context. With the context-aware IF-MIB, when SNMP requests that include a specified context mapped to a VRF instance are received, only information related to those interfaces that belong to the VRF associated with the context is obtained.

Retrieve IP Helper Addresses

The IF-MIB enables you to retrieve all IP helper addresses configured on each interface.

How to Enable IETF-Compliant Link Traps for SNMP

Configuration of the IF-MIB is optional on your system and is disabled by default. To configure you need to enable IETF-Compliant Link Traps for SNMP. Perform this task to enable the use of the new object list for SNMP linkUp/linkDown traps, use the following commands, starting in privileged EXEC mode:

SUMMARY STEPS

1. **enable**
2. **configure terminal**
3. **snmp-server trap link ietf**
4. **end**

DETAILED STEPS

	Command or Action	Purpose
Step 1	enable Example: Router> enable	Enables privileged EXEC mode. <ul style="list-style-type: none"> • Enter your password if prompted.
Step 2	configure terminal Example: Router# configure terminal	Enters global configuration mode.
Step 3	snmp-server trap link ietf Example: Router(config)# snmp-server trap link ietf	Enables SNMP traps that are compliant with RFC 2233.
Step 4	end Example:	Ends the current configuration session and returns you to privileged EXEC mode.

	Command or Action	Purpose
	Router(config)# end	

What to do next

Verifying IETF-Compliant Link Traps for SNMP

Use the **more system:running-config** command in privileged EXEC mode to verify that the command is in your running configuration file.

Troubleshooting Tips

To monitor SNMP trap activity in real-time for the purposes of troubleshooting, use the SNMP debug commands, including the **debug snmp packet** command. For documentation of SNMP debug commands, see the Release 12.4 *Cisco IOS Debug Command Reference*, available on Cisco.com at http://www.cisco.com/en/US/docs/ios/debug/command/reference/db_book.html, or on the Cisco Documentation CD-ROM.

Example to Enable IETF-Compliant Link Traps for SNMP

The following example shows the SNMP related output before the IETF-compliant implementation is enabled, a configuration session in which it is enabled, and the changed output after the configuration:

```

Router#
more system:running config
. . .
snmp-server engineID local 00000009000000A1616C2056
snmp-server community public RO
snmp-server community private RW
. . .
Router#
conf term

Enter configuration commands, one per line. End with CNTL/Z.
Router(config)#
snmp-server trap link ietf

Router(config)#
end
Router#
more system:running config
. . .
snmp-server engineID local 00000009000000A1616C2056
snmp-server community public RO
snmp-server community private RW
snmp-server trap link ietf
. . .

```

To enable/disable link traps for a particular interface:

```

7609_supBXL_45(config-if)#snmp trap link-status ?
permit Permit the following capability

```

```
<cr>
7609_supBXL_45(config-if)#
```

To enable link up/down traps during switchover:

```
7609_supBXL_45(config)#snmp-server trap link ?
 ietf          Use IETF standard for SNMP traps
 switchover    Enable link up/down traps during switchover
```

How to Configure SNMP and Use the IF-MIB

Configuring the Router to Use SNMP

Before you query IF-MIB feature using SNMP, you must first configure the router to support SNMP.



Note Some of the tasks in this section include examples of the SNMP CLI syntax used to set configuration parameters on the router and to read values from MIB objects on the router. These SNMP CLI syntax examples are taken from a Linux workstation using public domain SNMP tools. The SNMP CLI syntax for your workstation might be different. See the documentation that was provided with your SNMP tools for the correct syntax for your network management workstation.

SUMMARY STEPS

1. **enable**
2. **configure terminal**
3. **snmp-server community *string1* ro**
4. **snmp-server community *string2* rw**
5. **end**

DETAILED STEPS

	Command or Action	Purpose
Step 1	enable Example: Router> enable	Enables privileged EXEC mode. <ul style="list-style-type: none"> • Enter your password if prompted.
Step 2	configure terminal Example: Router# configure terminal	Enters global configuration mode.
Step 3	snmp-server community <i>string1</i> ro Example: Router(config)# snmp-server community public ro	Sets up the community access string to permit access to SNMP. <ul style="list-style-type: none"> • The <i>string1</i> argument is a community string that consists of from 1 to 32 alphanumeric characters and

	Command or Action	Purpose
		<p>functions much like a password, permitting access to the SNMP protocol. Blank spaces are not permitted in the community string.</p> <ul style="list-style-type: none"> The ro keyword specifies read-only access. SNMP management stations using this string can retrieve MIB objects. <p>Note The SNMP community read-only (RO) string for the examples is public. You should use a more complex string for this value in your configuration.</p>
Step 4	<p>snmp-server community <i>string2</i> rw</p> <p>Example:</p> <pre>Router(config)# snmp-server community private rw</pre>	<p>Sets up the community access string to permit access to SNMP.</p> <ul style="list-style-type: none"> The <i>string2</i> argument is a community string that consists of from 1 to 32 alphanumeric characters and functions much like a password, permitting access to the SNMP protocol. Blank spaces are not permitted in the community string. The rw keyword specifies read-write access. SNMP management stations using this string can retrieve and modify MIB objects. <p>Note The SNMP community read-write (RW) string for the examples is private. You should use a more complex string for this value in your configuration.</p>
Step 5	<p>end</p> <p>Example:</p> <pre>Router(config)# end</pre>	<p>Exits the current configuration mode and returns to privileged EXEC mode.</p>

What to Do Next

To implement the IF-MIB, you must configure a tunnel. For information on configuring tunnels, see the "Implementing Tunnels" chapter in this guide.

Additional References

Related Documents

Related Topic	Document Title
IPv6 addressing and connectivity	<i>IPv6 Configuration Guide</i>

Related Topic	Document Title
Cisco IOS commands	Cisco IOS Master Commands List, All Releases
IPv6 commands	Cisco IOS IPv6 Command Reference
Cisco IOS IPv6 features	Cisco IOS IPv6 Feature Mapping

Standards and RFCs

Standard/RFC	Title
RFCs for IPv6	<i>IPv6 RFCs</i>

MIBs

MIB	MIBs Link
	To locate and download MIBs for selected platforms, Cisco IOS releases, and feature sets, use Cisco MIB Locator found at the following URL: http://www.cisco.com/go/mibs

Technical Assistance

Description	Link
The Cisco Support and Documentation website provides online resources to download documentation, software, and tools. Use these resources to install and configure the software and to troubleshoot and resolve technical issues with Cisco products and technologies. Access to most tools on the Cisco Support and Documentation website requires a Cisco.com user ID and password.	http://www.cisco.com/cisco/web/support/index.html

Feature Information for IF-MIBs

The following table provides release information about the feature or features described in this module. This table lists only the software release that introduced support for a given feature in a given software release train. Unless noted otherwise, subsequent releases of that software release train also support that feature.

Use Cisco Feature Navigator to find information about platform support and Cisco software image support. To access Cisco Feature Navigator, go to www.cisco.com/go/cfn. An account on Cisco.com is not required.

Table 12: Feature Information for IF-MIB

Feature Name	Releases	Feature Information
IF-MIB	12.1(2)T 12.0(21)S3 12.3(2)T 12.0(24)S 12.2(2)SXI 12.2(33)SB Cisco IOS Release 3.9S	<p>A router can be configured using the RFC 2233 IETF standards-based implementation. The IF-MIB enables notification support for subinterfaces.</p> <p>The LinkUp/Down traps are generated when a link goes up or down. This feature updates the LinkUp/Down trap information to include ifAdminStatus and ifOperStatus.</p> <p>The IF-MIB supports the IP Helper addresses and enable you to retrieve all IP helper addresses configured on each interface.</p> <p>You have the ability to query the Interfaces MIB objects and the information returned is restricted to the VRF to which the SNMP context is mapped to. Notification hosts may also be configured with contexts to restrict the notifications that need to be sent to a particular host.</p>



CHAPTER 12

Synchronous Ethernet (SyncE) ESMC and SSM

This module describes Synchronization Status Message (SSM), Ethernet Synchronization Message Channel (ESMC), and generating the Simple Network Management Protocol (SNMP) traps on the SyncE feature.

With Ethernet equipment gradually replacing Synchronous Optical Networking (SONET) and Synchronous Digital Hierarchy (SDH) equipment in service-provider networks, frequency synchronization is required to provide high-quality clock synchronization over Ethernet ports.

Synchronous Ethernet (SyncE) provides the required synchronization at the physical level. In SyncE, Ethernet links are synchronized by timing their bit clocks from high-quality, stratum-1-traceable clock signals in the same manner as SONET/SDH. Operation messages maintain SyncE links and ensure that a node always derives timing from the most reliable source.

SyncE synchronizes clock frequency over an Ethernet port. In SONET/SDH the communication channel for conveying clock information is SSM, and in SyncE it is the ESMC.

- [Finding Feature Information, on page 109](#)
- [Prerequisites for Synchronous Ethernet \(SyncE\) ESMC and SSM, on page 110](#)
- [Restrictions for Synchronous Ethernet \(SyncE\) ESMC and SSM, on page 110](#)
- [Information About Synchronous Ethernet \(SyncE\) ESMC and SSM, on page 110](#)
- [How to Configure Synchronous Ethernet \(SyncE\) ESMC and SSM, on page 111](#)
- [Configuration Examples for Synchronous Ethernet \(SyncE\) ESMC and SSM, on page 116](#)
- [Additional References, on page 119](#)
- [Feature Information for Synchronous Ethernet \(SyncE\) ESMC and SSM, on page 120](#)

Finding Feature Information

Your software release may not support all the features documented in this module. For the latest feature information and caveats, see the release notes for your platform and software release. To find information about the features documented in this module, and to see a list of the releases in which each feature is supported, see the feature information table at the end of this module.

Use Cisco Feature Navigator to find information about platform support and software image support. To access Cisco Feature Navigator, go to <http://www.cisco.com/go/cfn>. An account on Cisco.com is not required.

Prerequisites for Synchronous Ethernet (SyncE) ESMC and SSM

You need to first configure the network clock for SyncE configuration. Automatic synchronization of the network clock should be enabled. Ensure that the **network-clock-select** and **network-clock-participate** commands do not exist in the configuration in order to continue with the SyncE configuration.

Restrictions for Synchronous Ethernet (SyncE) ESMC and SSM

- The **network-clock synchronization ssm option** command cannot be used if the following parameters have been configured:
 - Network clock input source using the **network-clock input-source** command.
 - Network clock quality level using the **network-clock quality-level** command.
 - Network clock source quality for any synchronous ethernet interface using the **network-clock source quality** command.



Note After using the **network-clock synchronization ssm option** command, the restricted configurations listed above can be used.

- The **network-clock synchronization ssm option** command must be compatible with the **network-clock eec** command in the configuration.
- The **esmc process** and **synchronous mode** commands can be used only if the SyncE capable interface is installed on the router.

Information About Synchronous Ethernet (SyncE) ESMC and SSM

Synchronous Ethernet (SyncE) ESMC and SSM

Customers using a packet network find it difficult to provide timing to multiple remote network elements (NEs) through an external time division multiplexed (TDM) circuit. The SyncE feature helps to overcome this problem by providing effective timing to the remote NEs through a packet network. SyncE leverages the physical layer of the Ethernet to transmit frequency to the remote sites. SyncE's functionality and accuracy resemble the SONET/SDH network because of its physical layer characteristic. SyncE uses ESMC to allow the best clock source traceability to correctly define the timing source and help prevent a timing loop.

SONET/SDH use 4 bits from the two S bytes in the SONET/SDH overhead frame for message transmission. Ethernet relies on ESMC that is based on an IEEE 802.3 organization-specific slow protocol for message transmission. Each NE along the synchronization path supports SyncE, and SyncE effectively delivers frequency in the path. SyncE does not support relative time (for example, phase alignment) or absolute time (Time of Day).

SyncE provides the Ethernet physical layer network (ETY) level frequency distribution of known common precision frequency references. Clocks for use in SyncE are compatible with the clocks used in the SONET/SDH synchronization network. To achieve network synchronization, synchronization information is transmitted through the network via synchronous network connections with performance of egress clock. In SONET/SDH the communication channel for conveying clock information is Synchronization Status Message (SSM), and in SyncE it is the Ethernet Synchronization Message Channel (ESMC).

ESMC carries a Quality Level (QL) identifier that identifies the timing quality of the synchronization trail. QL values in QL-TLV are the same as QL values defined for SONET and SDH SSM. Information provided by SSM QLs during the network transmission helps a node derive timing from the most reliable source and prevents timing loops. ESMC is used with the synchronization selection algorithms. Because Ethernet networks are not required to be synchronous on all links or in all locations, the ESMC channel provides this service. ESMC is composed of the standard Ethernet header for an organization-specific slow protocol; the ITU-T OUI, a specific ITU-T subtype; an ESMC-specific header; a flag field; and a type, length, value (TLV) structure. The use of flags and TLVs improves the management of SyncE links and the associated timing change. For details on Synchronous Ethernet support on Cisco 7600 series routers see [Cisco 7600 Series Ethernet Services Plus \(ES+\) and Ethernet Services Plus T \(ES+T\) Line Card Configuration Guide](#).

How to Configure Synchronous Ethernet (SyncE) ESMC and SSM

Configuring SyncE

Perform this task to configure SyncE using ESMC and SSM.

SUMMARY STEPS

1. **enable**
2. **network-clock set l ockout** {external slot / card / port [10m | 2m] t1 {sf | esf | d4}} | interface type slot / port}
3. **network-clock clear l ockout** {external slot / card / port [10m | 2m] t1 {sf | esf | d4}} | interface type slot / port}
4. **network-clock switch force** { external slot / card / port [10m | 2m] | t0 | t1 {sf | esf | d4} t0 | internal { external slot / card / port [10m | 2m] | t0} | interface type slot / port external slot / card / port [10m | 2m] | t0 }
5. **network-clock switch manual** { interface type slot /port { external slot / card / port [10m | 2m] | t0 } | external slot / card / port {10m | 2m | t0 | t1 {sf | esf | d4} | internal { external slot / card / port [10m | 2m] | t0} }
6. **network-clock clear switch** {t0 | external slot / card / port [10m | 2m]}
7. **configure terminal**
8. **network-clock synchronization automatic**
9. **network-clock synchronization ssm option** {1 | 2 {GEN1 | GEN2}}
10. **network-clock input-source priority** {external slot / card / port [10m | 2m | t1 {sf | esf | d4}} | interface type slot / port}
11. **network-clock synchronization mode ql-enabled**
12. **network-clock hold-off** {0 | milliseconds}

13. **network-clock wait-to-restore** *seconds*
14. **esmc process**
15. **network-clock external** *slot / card / port* **hold-off** {0 | *milliseconds*}
16. **network-clock quality-level** {**tx** | **rx**} *value* {**interface type slot / port** | **external slot / card / port** [10m | 2m | t1 {sf | esf | d4}]}
17. **network-clock output-source** {**line** | **system**} *priority interface type slot / port* **external slot / card / port** [10m | 2m | t1 {sf | esf | d4}]
18. **interface** *type number*
19. **synchronous mode**
20. **esmc mode** [ql-disabled | tx | rx] *value*
21. **network-clock source quality-level** *value* {**tx** | **rx**}
22. **network-clock hold-off** {0 | *milliseconds*}
23. **network-clock wait-to-restore** *seconds*
24. **end**

DETAILED STEPS

	Command or Action	Purpose
Step 1	enable Example: <pre>Router> enable</pre>	Enables privileged EXEC mode. <ul style="list-style-type: none"> • Enter your password if prompted.
Step 2	network-clock set l ockout { external slot / card / port [10m 2m t1 {sf esf d4}] interface type slot / port } Example: <pre>Router# network-clock set lockout GigabitEthernet7/1</pre>	Sets the lockout state of input to "on." The input then is no longer considered available by the selection process.
Step 3	network-clock clear lockout { external slot / card / port [10m 2m t1 {sf esf d4}] interface type slot / port } Example: <pre>Router# network-clock clear lockout GigabitEthernet7/1</pre>	Sets the lockout state of input to "off." The input then is considered available by the selection process.
Step 4	network-clock switch force { external slot / card / port [10m 2m] t0 t1 {sf esf d4} t0 internal { external slot / card / port [10m 2m] t0} interface type slot / port external slot / card / port [10m 2m] t0 } Example: <pre>Router# network-clock switch force interface GigabitEthernet 7/1 t0</pre>	Overrides the currently selected synchronization source when the synchronization source is enabled and not locked out. If the source selected by the forced switch command is disabled or locked out, the forced switch command is automatically rejected.
Step 5	network-clock switch manual { interface type slot / port { external slot / card / port [10m 2m] t0 }	Selects the synchronization source interface when it is enabled and not locked out. Manual switching is used to

	Command or Action	Purpose
	<p>external slot / card / port {10m 2m t0 t1 {sf esf d4} internal { external slot / card / port [10m 2m] t0} }</p> <p>Example:</p> <pre>Router# network-clock switch manual interface GigabitEthernet 7/1 t0</pre>	override the previously assigned synchronization source priorities.
Step 6	<p>network-clock clear switch {t0 external slot / card / port [10m 2m]}</p> <p>Example:</p> <pre>Router# network-clock clear switch t0</pre>	Clears the forced switch and manual switch commands. If the interface is not specified, the force/manual selected interface gets automatically cleared.
Step 7	<p>configure terminal</p> <p>Example:</p> <pre>Router# configure terminal</pre>	Enters global configuration mode.
Step 8	<p>network-clock synchronization automatic</p> <p>Example:</p> <pre>Router(config)# network-clock synchronization automatic</pre>	Enables the network clock selection algorithm. This command disables the Cisco-specific network clock process and turns on the G.781-based automatic clock selection process.
Step 9	<p>network-clock synchronization ssm option {1 2{GEN1 GEN2}}</p> <p>Example:</p> <pre>Router(config)# network-clock synchronization ssm option 2 GEN2</pre>	<p>Configures the router to work in a synchronization network.</p> <ul style="list-style-type: none"> • Option 1 refers to synchronization networks designed for Europe. This is the default value. • Option 2 refers to synchronization networks designed for United States.
Step 10	<p>network-clock input-source <i>priority</i> {external slot / card / port [10m 2m t1 {sf esf d4}] interface type slot / port}</p> <p>Example:</p> <pre>Router(config)# network-clock input-source 1 interface GigabitEthernet 7/1</pre>	Enables selecting an interface that is configured as clock source line, an external timing input interface, a GPS interface, or a packet-based timing recovered clock as the input clock for the system. Interface can be SyncE or channelized SONET.
Step 11	<p>network-clock synchronization mode ql-enabled</p> <p>Example:</p> <pre>Router(config)# network-clock synchronization mode ql-enabled</pre>	<p>Configures the automatic selection process ql-enabled mode.</p> <ul style="list-style-type: none"> • QL is disabled by default. • ql-enabled mode can be used only when the synchronization interface is capable to send SSM.

	Command or Action	Purpose
Step 12	network-clock hold-off {0 <i>milliseconds</i> } Example: Router(config)# network-clock hold-off 0	(Optional) Configures hold-off timer for the interface.
Step 13	network-clock wait-to-restore <i>seconds</i> Example: Router(config)# network-clock wait-to-restore 70	(Optional) Configures wait-to-restore timer for the SyncE interface.
Step 14	esmc process Example: Router(config)# esmc process	Enables the ESMC process.
Step 15	network-clock external <i>slot / card / port</i> hold-off {0 <i>milliseconds</i> } Example: Router(config)# network-clock external 0/1/0 hold-off 0	Overrides the hold-off timer value for the external interface.
Step 16	network-clock quality-level { <i>tx</i> <i>rx</i> } <i>value</i> { interface <i>type slot / port</i> external <i>slot / card / port</i> [10m 2m t1 { sf esf d4 }] Example: Router(config)# network-clock quality-level rx QL-STU GigabitEthernet 0/0/0	Forces the QL value for line or external timing input and output.
Step 17	network-clock output-source { line system } <i>priority</i> <i>interface type slot / port</i> external <i>slot / card / port</i> [10m 2m t1 { sf esf d4 }] Example: Router(config)# network-clock output-source line 1 GigabitEthernet1/2 external 0/0/1 10m	Transmits the signal from the external timing input interface to the external timing output interface.
Step 18	interface <i>type number</i> Example: Router(config)# interface GigabitEthernet 0/0	Enters interface configuration mode.
Step 19	synchronous mode Example: Router(config-if)# synchronous mode	Configures the Ethernet interface to synchronous mode and automatically enables the ESMC and QL process on the interface.

	Command or Action	Purpose
Step 20	esmc mode [ql-disabled tx rx] <i>value</i> Example: <pre>Router(config-if)# esmc mode rx QL-STU</pre>	(Optional) Enables the ESMC process on the interface.
Step 21	network-clock source quality-level <i>value</i> {tx rx} Example: <pre>Router(config-if)# network-clock source quality-level QL-ST4 tx</pre>	(Optional) Provides the forced QL value to the local clock selection process.
Step 22	network-clock hold-off {0 <i>milliseconds</i> } Example: <pre>Router(config-if)# network-clock hold-off 0</pre>	(Optional) Configures the hold-off timer for the interface.
Step 23	network-clock wait-to-restore <i>seconds</i> Example: Example: <pre>Router(config-if)# network-clock wait-to-restore 70</pre>	(Optional) Configures the wait-to-restore timer for the SyncE interface.
Step 24	end Example: <pre>Router(config-if)# end</pre>	Exits interface configuration mode and returns to privileged EXEC mode.

Enabling and Disabling an SNMP Trap in the SyncE Event

A Simple Network Management Protocol (SNMP) trap is defined for an SNMP agent to notify the Network Management Systems (NMS) about any unsolicited information. The SNMP trap notifies NMS when a critical SyncE event occurs on a device. If the SNMP trap is enabled in the SyncE configuration, the SNMP agent code generates a SyncE trap for the SyncE events.

Perform the following tasks to enable and disable the SNMP trap for the SyncE event:

SUMMARY STEPS

1. **enable**
2. **configure terminal**
3. **snmp-server enable traps netsync**
4. **no snmp-server enable traps netsync**
5. **end**
6. **show running-config all |include traps**

DETAILED STEPS

	Command or Action	Purpose
Step 1	enable Example: Router> enable	Enables privileged EXEC mode. <ul style="list-style-type: none"> • Enter your password if prompted.
Step 2	configure terminal Example: Router# configure terminal	Enters global configuration mode.
Step 3	snmp-server enable traps netsync Example: Router(config)# snmp-server enable traps netsync	Enables the SyncE traps.
Step 4	no snmp-server enable traps netsync Example: Router(config)# no snmp-server enable traps netsync	(Optional) Disables the SyncE traps.
Step 5	end Example: Router(config)# end	Exits global configuration mode.
Step 6	show running-config all include traps Example: Router# show running-config all include trap	(Optional) Displays the SyncE traps that are enabled on the router.

Configuration Examples for Synchronous Ethernet (SyncE) ESMC and SSM

Example Synchronous Ethernet (SyncE) ESMC and SSM

The following examples shows the SyncE configuration sequence (configuring an interface with two SyncE interfaces and two external interfaces):

```
Interface GigabitEthernet0/0/0
  synchronous mode
  clock source line
```

```

network-clock wait-to-restore 720
!
Interface GigabitEthernet1/0/0
    synchronous mode
    clock source line
!
network-clock synchronization automatic
network-clock input-source 1 external 0/0/0 2m
network-clock input-source 2 external 1/0/0 2m
network-clock output-source line 1 interface GigabitEthernet0/0/0 external 0/0/0 2m
network-clock output-source line 1 interface GigabitEthernet1/0/0 external 1/0/0 2m

```

The following examples shows how to verify whether ESMC is enabled or not:

```

Router# show esmc

Interface: GigabitEthernet0/0/0
Administrative configurations:
  Mode: Synchronous
  ESMC TX: Enable
  ESMC RX : Enable
  QL RX configured : NA
  QL TX configured : NA
Operational status:
  Port status: UP
  QL Receive: QL-SSU-B
  ESMC Information rate : 1 packet/second
  ESMC Expiry: 5 second

```

The following examples shows how to view the network clock synchronization details:

```

Router# show network-clock synchronization detail

Automatic selection process : Enable
Equipment Clock : 2048 (EEC-Option1)
Clock Mode : QL-Enable
ESMC : Disabled
SSM Option : 1
T0 : Internal
Hold-off (global) : 300 ms
Wait-to-restore (global) : 300 sec
Revertive : No
Force Switch: FALSE
Manual Switch: FALSE
Number of synchronization sources: 1
Secondary src: Ethernet0/0
Slots disabled 0x0
Monitor source(s): Ethernet0/0
Selected QL: QL-SEC
sm(netsync_ql_dis NETCLK_QL_ENABLE), running yes, state 1A
Last transition recorded: (begin)-> 1A (ql_mode_enable)-> 1A (src_added)-> 1A

Nominated Interfaces

Interface          SigType    Mode/QL    Prio  QL_IN  ESMC Tx  ESMC Rx
*Internal          NA         NA/Dis     251   QL-SEC NA        NA
Et0/0              NA         Sync/En    2     QL-DNU -         -

Interface:
-----
Local Interface: Internal

```

```

Signal Type: NA
Mode: NA(QL-enabled)
SSM Tx: Disable
SSM Rx: Disable
Priority: 251
QL Receive: QL-SEC
QL Receive Configured: -
QL Receive Overridden: -
QL Transmit: -
QL Transmit Configured: -
Hold-off: 0
Wait-to-restore: 0
Lock Out: FALSE
Signal Fail: FALSE
Alarms: FALSE
Slot Disabled: FALSE

Local Interface: Et0/0
Signal Type: NA
Mode: Synchronous(QL-enabled)
ESMC Tx: Enable
ESMC Rx: Enable
Priority: 2
QL Receive: QL-DNU
QL Receive Configured: -
QL Receive Overridden: -
QL Transmit: -
QL Transmit Configured: -
Hold-off: 300
Wait-to-restore: 300
Lock Out: FALSE
Signal Fail: FALSE
Alarms: FALSE
Slot Disabled: FALSE
Dont Use: FALSE
Configured Priority: 2
Force Switch: FALSE
Manual Switch: FALSE
Manual Switch In progress: FALSE
Holdoff_cfg: FALSE
Wtr_cfg: FALSE
Reason for alarm flag: 0
Msw in progress: FALSE
Intf_sig_nv: 0
Hold off Timer: Stopped
Wait to restore Timer: Stopped
Switchover Timer: Stopped
ESMC Tx Timer: Stopped
ESMC Rx Timer: Stopped
Tsm Delay Timer: Stopped

```

Example Enabling and Disabling an SNMP Trap in the SyncE Event

The following example shows how to enable and disable an SNMP trap in the SyncE event:

```

Router > enable
Router # configure terminal
Router(config)# snmp-server enable traps netsync
Router (config)# no snmp-server enable traps netsync
Router (config)# end

```

```
Router# show running-config all | include traps
snmp-server enable traps flowmon
snmp-server enable traps sonet
snmp-server enable traps netsync
```

Additional References

Related Documents

Related Topic	Document Title
Cisco IOS commands	Cisco IOS Master Commands List, All Releases
Interface and hardware component configuration commands	<i>Cisco IOS Interface and Hardware Component Command Reference</i>
Cisco 7600 Synchronous Ethernet	Cisco 7600 Series Ethernet Services Plus (ES+) and Ethernet Services Plus T (ES+T) Line Card Configuration Guide

Standards

Standard	Title
ITU-T G.8262	<i>Timing characteristics of synchronous ethernet equipment slave clock (EEC)</i>
ITU-T G.8264	<i>Timing distribution through Packet Networks</i>
ITU-T G.781	<i>Synchronization layer functions</i>

MIBs

MIB	MIBs Link
CISCO-NETSYNC-MIB	To locate and download MIBs for selected platforms, Cisco software releases, and feature sets, use Cisco MIB Locator found at the following URL: http://www.cisco.com/go/mibs

RFCs

RFC	Title
None	--

Technical Assistance

Description	Link
The Cisco Support and Documentation website provides online resources to download documentation, software, and tools. Use these resources to install and configure the software and to troubleshoot and resolve technical issues with Cisco products and technologies. Access to most tools on the Cisco Support and Documentation website requires a Cisco.com user ID and password.	http://www.cisco.com/cisco/web/support/index.html

Feature Information for Synchronous Ethernet (SyncE) ESMC and SSM

The following table provides release information about the feature or features described in this module. This table lists only the software release that introduced support for a given feature in a given software release train. Unless noted otherwise, subsequent releases of that software release train also support that feature.

Use Cisco Feature Navigator to find information about platform support and Cisco software image support. To access Cisco Feature Navigator, go to www.cisco.com/go/cfn. An account on Cisco.com is not required.

Table 13: Feature Information for Synchronous Ethernet (SyncE): ESMC and SSM

Feature Name	Releases	Feature Information
Generating SNMP Trap in SyncE Feature	15.1(2)S Cisco IOS XE Release 3.8S	This feature describes how to set SNMP traps in SyncE to notifies the NMS about any unsolicited information. The following commands were introduced or modified by this feature: no snmp-server enable traps netsync, show running-config all include trap, snmp-server enable traps netsync.
Synchronous Ethernet (SyncE): ESMC and SSM	15.0(1)S Cisco IOS XE Release 3.8S	This feature supports ESMC and the SSM control protocol for SyncE to synchronize clock frequency over an Ethernet port with quality level selection. The following commands were introduced or modified by this feature: esmc mode ql-disabled, esmc process, show esmc, show interfaces accounting.



CHAPTER 13

1+1 SR-APS Without Bridging

The Automatic Protection Switching (APS) feature provides link redundancy and allows switchover of Packet over SONET (POS) circuits in the event of circuit failure and is often required when you connect Synchronous Optical Networking (SONET) equipment to telecommunications equipment. In the single router (SR) APS feature both protect and working interfaces must be on same router.

APS is a mechanism of using a protect POS interface in the SONET network as the backup for a working POS interface. When the working interface fails, the protect interface quickly assumes its traffic load. Based on the configuration, the two circuits can be terminated in the same router. The protection mechanism has a 1+1 architecture with bidirectional connection. Bridging refers to the transmission of user data to both working interface and protect interface. In nonbridging scenario the user data is sent to working interface only.

- [Finding Feature Information, on page 121](#)
- [Prerequisites for 1+1 SR-APS Without Bridging, on page 121](#)
- [Restrictions for 1+1 SR-APS Without Bridging, on page 122](#)
- [Information About 1+1 SR-APS Without Bridging, on page 122](#)
- [How to Configure 1+1 SR-APS Without Bridging, on page 123](#)
- [Configuration Examples for 1+1 SR-APS Without Bridging, on page 129](#)
- [Additional References, on page 131](#)
- [Feature Information for 1+1 SR-APS Without Bridging, on page 132](#)

Finding Feature Information

Your software release may not support all the features documented in this module. For the latest caveats and feature information, see [Bug Search Tool](#) and the release notes for your platform and software release. To find information about the features documented in this module, and to see a list of the releases in which each feature is supported, see the feature information table.

Use Cisco Feature Navigator to find information about platform support and Cisco software image support. To access Cisco Feature Navigator, go to www.cisco.com/go/cfn. An account on Cisco.com is not required.

Prerequisites for 1+1 SR-APS Without Bridging

Configure the working interface first, along with the IP address of the interface. This configuration helps to prevent the protect interface from becoming the active circuit during APS configuration. If the protect interface

becomes active in case if it has been configured first by mistake, you can use **shut** or **no shut** command to make the working interface active.

Restrictions for 1+1 SR-APS Without Bridging

- Both the protect and working interfaces should be configured identically. No warning message will be displayed if the configurations are different between the interfaces.
- Behavior of the APS pair (protect and working interfaces) will be indeterministic if the configurations of protect and working interfaces are not identical.
- APS switch over within 50 milliseconds is not supported during online insertion and removal (OIR) or during crash of the shared port adapter (SPA) or carrier card (CC).
- APS switching simultaneously with Route Processor (RP) or forwarding plane (FP) high availability (HA) need not be within 50 milliseconds.

Information About 1+1 SR-APS Without Bridging

1+1 SR-APS Without Bridging

The APS feature provides link redundancy and allows switchover of POS circuits in the event of circuit failure and is often required when you connect SONET equipment to telecommunications equipment. In the SR-APS feature both protect and working interfaces must be on same router.

APS is a mechanism of using a protect POS interface in the SONET network as the backup for a working POS interface. When the working interface fails, the protect interface quickly assumes its traffic load. Based on the configuration, the two circuits can be terminated in the same router. The protection mechanism has a 1+1 architecture with bidirectional connection.

In the 1+1 architecture, there is one working interface (circuit) and one protect interface, and the same payload from the transmitting end is sent to both the receiving ends. The receiving end decides the interface that needs to be used. The line overhead (LOH) bytes (K1 and K2) in the SONET frame indicate both status and action. When one interface is down or the K1/K2 bytes have changed, APS brings up the protect interface using regular interface configuration messages.

Bridging refers to the transmission of user data to both the working interface and the protect interface. In nonbridging scenario the user data is sent to the working interface only. You must set the working interface to be the active interface. Cisco ASR 1000 Series Routers (ASR1000) supports only the nonbridging scenario.

In the nonbridging scenario the ASR1000 (with the APS enabled) transmits a signal to the remote end. The ASR1k transmits the signal (except K1/K2 bytes) only to the working interface and not to the protect interface. The K1/K2 bytes are transmitted only to the protect interface. However, ASR1000 can be connected to devices that support bridging APS, which means the devices transmit the same signal to both working and protect interfaces of ASR1000. But the ASR1000 will send the user data (except K1/K2 bytes) only to the working interface of that device. The K1/K2 bytes are transmitted to the protect interface.

SR-APS uses Protect Group Protocol (PGP) between working and protect interfaces. The protect interface APS configuration should include an IP address of a loopback interface on the same router to communicate with the working interface using PGP. Using the PGP, POS interfaces can be switched in case of a degradation

or loss of channel signal, or manual intervention. In bidirectional mode, the receive and transmit channels are switched as a pair.

In bidirectional APS the local and the remote connections negotiate the ingress interface to be selected for the data path. The egress interface traffic is not transmitted to both working and protect interfaces.

How to Configure 1+1 SR-APS Without Bridging

Configuring APS Working and Protect Interfaces

Perform this task to configure APS working and protect interfaces.

SUMMARY STEPS

1. **enable**
2. **configure terminal**
3. **interface pos** *slot/sub-slot/port*
4. **aps working** *circuit-number*
5. **aps protect** *circuit-number ip-address*
6. **end**
7. **show controllers pos**
8. **show interfaces pos**
9. **show aps**

DETAILED STEPS

	Command or Action	Purpose
Step 1	enable Example: Router> enable	Enables privileged EXEC mode. • Enter your password if prompted.
Step 2	configure terminal Example: Router# configure terminal	Enters global configuration mode.
Step 3	interface pos <i>slot/sub-slot/port</i> Example: Router(config)# interface pos 2/0/0	Specifies the POS interface to be configured as the working interface and enters interface configuration mode.
Step 4	aps working <i>circuit-number</i> Example: Router(config-if)# aps working 1	Configures the interface as a working interface.

	Command or Action	Purpose
Step 5	aps protect <i>circuit-number ip-address</i> Example: Router(config-if)# <code>aps protect 1 209.165.200.224</code>	Configures the interface as a protect interface. Specifies the IP address of loopback interface on the same router that contains the working interface.
Step 6	end Example: Router(config-if)# <code>end</code>	Exits interface configuration mode and returns to privileged EXEC mode.
Step 7	show controllers pos Example: Router(config)# <code>show controllers pos</code>	Displays information about the POS controllers so that you can verify that the interface is configured correctly.
Step 8	show interfaces pos Example: Router(config)# <code>show interfaces pos</code>	Displays information about the configured interfaces.
Step 9	show aps Example: Router(config)# <code>show aps</code>	Displays information about APS on the configured router.

Configuring Other APS Options

Perform this task to configure other APS options.

SUMMARY STEPS

1. **enable**
2. **configure terminal**
3. **interface pos** *slot/sub-slot/port*
4. **aps force** *circuit-number*
5. **aps group** *group-number*
6. **aps lockout** *circuit-number*
7. **aps manual** *circuit-number*
8. **aps revert** *minutes*
9. **end**

DETAILED STEPS

	Command or Action	Purpose
Step 1	enable	Enables privileged EXEC mode.

	Command or Action	Purpose
	Example: Router> enable	<ul style="list-style-type: none"> Enter your password if prompted.
Step 2	configure terminal Example: Router# configure terminal	Enters global configuration mode.
Step 3	interface pos slot/sub-slot/port Example: Router(config)# interface pos 2/0/0	Specifies the POS interface to be configured as the working interface and enters interface configuration mode.
Step 4	aps force circuit-number Example: Router(config-if)# aps force 1	(Optional) Manually switches the specified circuit to a protect interface, unless a request of equal or higher priority is in effect.
Step 5	aps group group-number Example: Router(config-if)# aps group 20	(Optional) Allows more than one protect or working interface group to be supported on a router.
Step 6	aps lockout circuit-number Example: Router(config-if)# aps lockout 1	(Optional) Prevents a working interface from switching to a protect interface.
Step 7	aps manual circuit-number Example: Router(config-if)# aps manual 1	(Optional) Manually switches a circuit to a protect interface, unless a request of equal or higher priority is in effect.
Step 8	aps revert minutes Example: Router(config-if)# aps revert 3	(Optional) Enables automatic switchover from the protect interface to the working interface after the working interface becomes available.
Step 9	end Example: Router(config-if)# end	Exits interface configuration mode and returns to privileged EXEC mode.

Monitoring and Maintaining APS

Perform this task to monitor and maintain APS.

SUMMARY STEPS

1. **enable**
2. **configure terminal**
3. **show controllers pos**
4. **show interfaces pos**
5. **show aps**

DETAILED STEPS

	Command or Action	Purpose
Step 1	enable Example: <pre>Router> enable</pre>	Enables privileged EXEC mode. <ul style="list-style-type: none"> • Enter your password if prompted.
Step 2	configure terminal Example: <pre>Router# configure terminal</pre>	Enters global configuration mode.
Step 3	show controllers pos Example: <pre>Router(config)# show controllers pos</pre>	Displays information about the POS controllers so that you can verify that the interface is configured correctly.
Step 4	show interfaces pos Example: <pre>Router(config)# show interfaces pos</pre>	Displays information about the configured interfaces.
Step 5	show aps Example: <pre>Router(config)# show aps</pre>	Displays information about APS on the configured router.

Configuring SONET Alarm Reporting

To configure the thresholds and the type of SONET alarms that are reported, use any of the following commands. The commands listed in this section are optional. To display the current Bit Error Rate (BER) threshold setting or to view the reporting of the SONET alarms, use the **show controllers pos** command.

SUMMARY STEPS

1. **enable**
2. **configure terminal**
3. **interface pos** *slot/sub-slot/port*
4. **pos threshold** {**b1-tca** | **b2-tca** | **b3-tca** | **sd-ber** | **sf-ber**} *rate*

5. `pos report {b1-tca | b2-tca | b3-tca | lais | lrldi | pais | plop | prdi | rdool | sd-ber | sf-ber | slof | slos}`
6. `end`

DETAILED STEPS

	Command or Action	Purpose
Step 1	enable Example: <pre>Router> enable</pre>	Enables privileged EXEC mode. <ul style="list-style-type: none"> • Enter your password if prompted.
Step 2	configure terminal Example: <pre>Router# configure terminal</pre>	Enters global configuration mode.
Step 3	interface pos slot/sub-slot/port Example: <pre>Router(config)# interface pos 2/0/0</pre>	Specifies the POS interface to be configured as the working interface and enters interface configuration mode.
Step 4	pos threshold {b1-tca b2-tca b3-tca sd-ber sf-ber} rate Example: <pre>Router(config-if)# pos threshold b1-tca 4</pre>	(Optional) Configures the BER threshold values for signal failure (SF), signal degrade (SD), or threshold crossing alarms (TCAs).
Step 5	pos report {b1-tca b2-tca b3-tca lais lrldi pais plop prdi rdool sd-ber sf-ber slof slos} Example: <pre>Router(config-if)# pos report b2-tca</pre>	(Optional) Enables reporting of selected SONET alarms.
Step 6	end Example: <pre>Router(config-if)# end</pre>	Exits interface configuration mode and returns to privileged EXEC mode.

Configuring LAIS as an APS Switchover Trigger

When you place the working interface into administrative shutdown state, the switchover happens with or without `pos ais-shut`. When `pos ais-shut` is enabled on the interface, the interface sends the line alarm indication signal (LAIS) alarm to the remote end of the administrative shutdown, and the LAIS alarm makes the switchover bit faster. The `carrier-delay msec milliseconds` command and `ppp timeout retry seconds [milliseconds]` command are also used to make the APS switchover happen faster.

The `carrier-delay msec milliseconds` command delays the link down event processing for POS interfaces. For example, if the carrier delay is set to 50 milliseconds (ms), the router will ignore all link down events that

are cleared within 50 msec. If the link goes down there will be no APS switchover for 50 ms. The default carrier delay is 2 seconds and there will be no APS switchover for 2 seconds after the link goes down. Hence the carrier delay is set to 50 ms for faster switchover.

The **ppp timeout retry seconds** [*milliseconds*] command sets the PPP retry timeout to the specified time. For example, if the timeout retry is set to 200 ms, the router tries to establish PPP link in 200 ms after it detects the signal outage due to APS switchover. If the default retry timeout of 2 seconds is used, then the PPP link will be established 2 seconds after the APS switchover. Hence the PPP timeout retry is set to 50 ms for faster switchover.

SUMMARY STEPS

1. **enable**
2. **configure terminal**
3. **interface pos** *slot/sub-slot/port*
4. **pos ais-shut**
5. **carrier-delay msec** *milliseconds*
6. **ppp timeout retry seconds** [*milliseconds*]
7. **end**

DETAILED STEPS

	Command or Action	Purpose
Step 1	enable Example: Router> enable	Enables privileged EXEC mode. <ul style="list-style-type: none"> • Enter your password if prompted.
Step 2	configure terminal Example: Router# configure terminal	Enters global configuration mode.
Step 3	interface pos <i>slot/sub-slot/port</i> Example: Router(config)# interface pos 2/0/0	Specifies the POS interface to be configured as the working interface and enters interface configuration mode.
Step 4	pos ais-shut Example: Router(config-if)# pos ais-shut	Sends line alarm indication signal (LAIS) alarm on Admin shut of the interface.
Step 5	carrier-delay msec <i>milliseconds</i> Example: Router(config-if)# carrier-delay msec 50	Delays the link down event processing for POS interfaces and makes the APS switchover faster.

	Command or Action	Purpose
Step 6	<p>ppp timeout retry seconds <i>[milliseconds]</i></p> <p>Example:</p> <pre>Router(config-if)# ppp timeout retry 0 200</pre>	Sets the maximum waiting period for a response during PPP negotiation and makes the APS switchover faster.
Step 7	<p>end</p> <p>Example:</p> <pre>Router(config-if)# end</pre>	Exits interface configuration mode and returns to privileged EXEC mode.

Configuration Examples for 1+1 SR-APS Without Bridging

Example Configuring 1+1 SR-APS Without Bridging

The following example shows the configuration sequence for 1+1 SR-APS:

```
interface loopback 1
ip address 1.1.1.1 255.255.255.0
interface pos 2/0/0
    aps group 1
    aps working 1
    pos ais-shut
end
interface pos 3/0/0
    aps group 1
    aps protect 1 1.1.1.1
    pos ais-shut
end
```

The following example shows the sample output of APS configured on a router with a working interface:

```
Router# show aps
POS2/1/1 APS Group 0: protect channel 0 (Inactive)
    Working channel 1 at 10.0.1.1 (Enabled)
    bidirectional, revertive (60 seconds)
    PGP timers (default): hello time=1; hold time=3
        hello fail revert time=120
    SONET framing; SONET APS signalling by default
    Received K1K2: 0x00 0x05
        No Request (Null)
    Transmitted K1K2: 0x00 0x05
        No Request (Null)
    Remote APS configuration: (null)
POS2/1/0 APS Group 0: working channel 1 (Active)
    Protect at 10.0.1.1
    PGP timers (from protect): hello time=1; hold time=3
    SONET framing
    Remote APS configuration: (null)
```

The following example shows the display of POS controllers:

```
Router# show controller pos 2/1/0
```

Example Configuring 1+1 SR-APS Without Bridging

```

POS2/1/0
SECTION
  LOF = 0          LOS   = 1          BIP(B1) = 0
LINE
  AIS = 2          RDI   = 2          FEBE = 14          BIP(B2) = 0
PATH
  AIS = 2          RDI   = 2          FEBE = 4          BIP(B3) = 6
  PLM = 0          UNEQ  = 0          TIM  = 0          TIU   = 0
  LOP = 1          NEWPTR = 2        PSE  = 0          NSE   = 0
Active Defects: None
Active Alarms: None
Alarm reporting enabled for: SF SLOS SLOF B1-TCA B2-TCA PLOP B3-TCA
Framing: SONET
APS
  working (active)
  COAPS = 13       PSBF = 0
  State: PSBF_state = False
  Rx(K1/K2): 00/00 Tx(K1/K2): 00/00
  Rx Synchronization Status S1 = 00
  S1S0 = 00, C2 = CF
  Remote aps status (none); Reflected local aps status (none)
CLOCK RECOVERY
  RDOOL = 0
  State: RDOOL_state = False
PATH TRACE BUFFER: STABLE
  Remote hostname : SPA-APS2
  Remote interface: POS2/2/0
  Remote IP addr  : 10.1.1.1
  Remote Rx(K1/K2): 00/00 Tx(K1/K2): 00/00
BER thresholds: SF = 10e-3 SD = 10e-6
TCA thresholds: B1 = 10e-6 B2 = 10e-6 B3 = 10e-6
Clock source: internal

```

The following example shows the configuration information and statistics for a POS interface:

```

Router# show interface pos 2/1/0
POS2/1/0 is up, line protocol is up (APS working - active)
  Hardware is SPA-4XOC12-POS
  Internet address is 10.1.1.2/24
  MTU 4470 bytes, BW 155000 Kbit/sec, DLY 100 usec,
    reliability 255/255, txload 1/255, rxload 1/255
  Encapsulation HDLC, crc 16, loopback not set
  Keepalive set (10 sec)
  Scramble disabled
  Last input 00:00:02, output 00:00:01, output hang never
  Last clearing of "show interface" counters never
  Input queue: 0/375/0/0 (size/max/drops/flushes); Total output drops: 0
  Queueing strategy: fifo
  Output queue: 0/40 (size/max)
  30 second input rate 0 bits/sec, 0 packets/sec
  30 second output rate 0 bits/sec, 0 packets/sec
    102477 packets input, 2459448 bytes, 0 no buffer
    Received 0 broadcasts (0 IP multicasts)
    0 runts, 4 giants, 0 throttles 0 parity
    4 input errors, 0 CRC, 0 frame, 0 overrun, 0 ignored, 0 abort
    102486 packets output, 2459934 bytes, 0 underruns
    0 output errors, 0 applique, 2 interface resets
    0 unknown protocol drops
    0 output buffer failures, 0 output buffers swapped out
    10 carrier transitions

```

Additional References

Related Documents

Related Topic	Document Title
APS commands	<i>Cisco IOS Interface and Hardware Component Command Reference</i>

Standards

Standard	Title
None	--

MIBs

MIB	MIBs Link
None	To locate and download MIBs for selected platforms, Cisco software releases, and feature sets, use Cisco MIB Locator found at the following URL: http://www.cisco.com/go/mibs

RFCs

RFC	Title
None	

Technical Assistance

Description	Link
<p>The Cisco Support website provides extensive online resources, including documentation and tools for troubleshooting and resolving technical issues with Cisco products and technologies.</p> <p>To receive security and technical information about your products, you can subscribe to various services, such as the Product Alert Tool (accessed from Field Notices), the Cisco Technical Services Newsletter, and Really Simple Syndication (RSS) Feeds.</p> <p>Access to most tools on the Cisco Support website requires a Cisco.com user ID and password.</p>	http://www.cisco.com/cisco/web/support/index.html

Feature Information for 1+1 SR-APS Without Bridging

The following table provides release information about the feature or features described in this module. This table lists only the software release that introduced support for a given feature in a given software release train. Unless noted otherwise, subsequent releases of that software release train also support that feature.

Use Cisco Feature Navigator to find information about platform support and Cisco software image support. To access Cisco Feature Navigator, go to www.cisco.com/go/cfn. An account on Cisco.com is not required.

Table 14: Feature Information for 1+1 SR-APS Without Bridging

Feature Name	Releases	Feature Information
1+1 SR-APS Without Bridging	Cisco IOS XE Release 3.1S	This feature provides support to 1+1 single router APS without bridging. There were no commands introduced or modified by this feature.



CHAPTER 14

IPv6 Rapid Deployment

The IPv6 rapid deployment feature allows a service provider to provide a unicast IPv6 service to customers over its IPv4 network by using encapsulation of IPv6 in IPv4.

- [Finding Feature Information, on page 133](#)
- [Information About IPv6 Rapid Deployment, on page 133](#)
- [How to Configure IPv6 Rapid Deployment, on page 135](#)
- [Configuration Examples for IPv6 Rapid Deployment, on page 137](#)
- [Additional References, on page 137](#)
- [Feature Information for IPv6 Rapid Deployment, on page 138](#)

Finding Feature Information

Your software release may not support all the features documented in this module. For the latest caveats and feature information, see [Bug Search Tool](#) and the release notes for your platform and software release. To find information about the features documented in this module, and to see a list of the releases in which each feature is supported, see the feature information table.

Use Cisco Feature Navigator to find information about platform support and Cisco software image support. To access Cisco Feature Navigator, go to www.cisco.com/go/cfn. An account on Cisco.com is not required.

Information About IPv6 Rapid Deployment

IPv6 Rapid Deployment Tunnels

The 6RD feature is an extension of the 6to4 feature. The 6RD feature allows a service provider (SP) to provide a unicast IPv6 service to customers over its IPv4 network by using encapsulation of IPv6 in IPv4.

The main differences between 6RD and 6to4 tunneling are as follows:

- 6RD does not require addresses to have a 2002::/16 prefix; therefore, the prefix can be from the SP's own address block. This function allows the 6RD operational domain to be within the SP network. From the perspective of customer sites and the general IPv6 internet connected to a 6RD-enabled SP network, the IPv6 service provided is equivalent to native IPv6.

- All 32 bits of the IPv4 destination need not be carried in the IPv6 payload header. The IPv4 destination is obtained from a combination of bits in the payload header and information on the router. Furthermore, the IPv4 address is not at a fixed location in the IPv6 header as it is in 6to4.

The 6RD SP prefix was selected by the SP for the IPv6 deployment shown in the figure below. The 6RD delegated prefix is derived from the SP prefix and the IPv4 address bits, and is used by the CE for hosts within its site.

Figure 4: 6RD Deployment

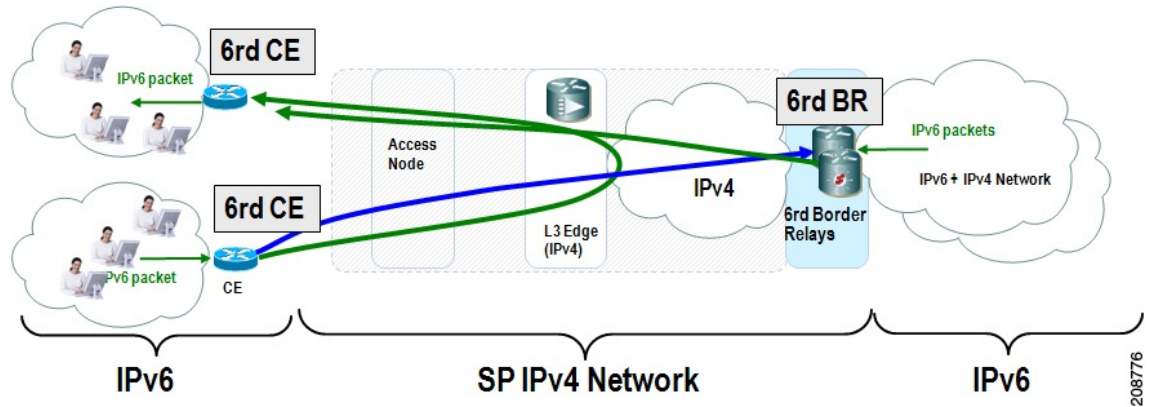

The figure below shows how 6RD prefix delegation works.

Figure 5: 6RD Prefix Delegation Explanation

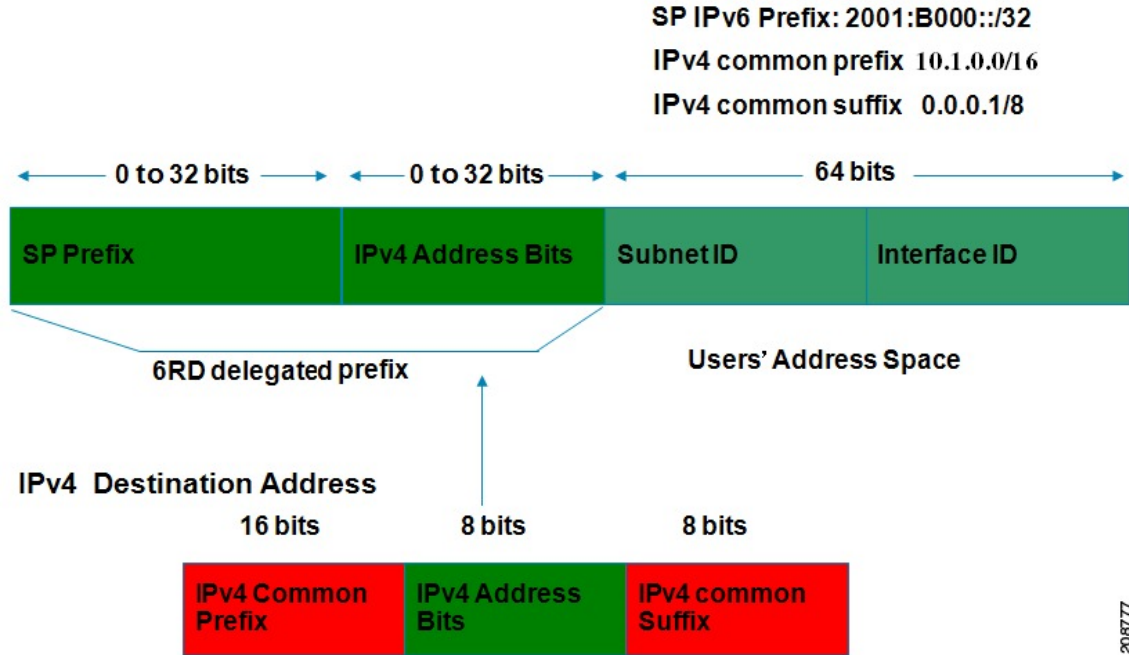

The figure below shows a 6RD prefix delegation topology.

Figure 6: 6RD Prefix Delegation and Explanation

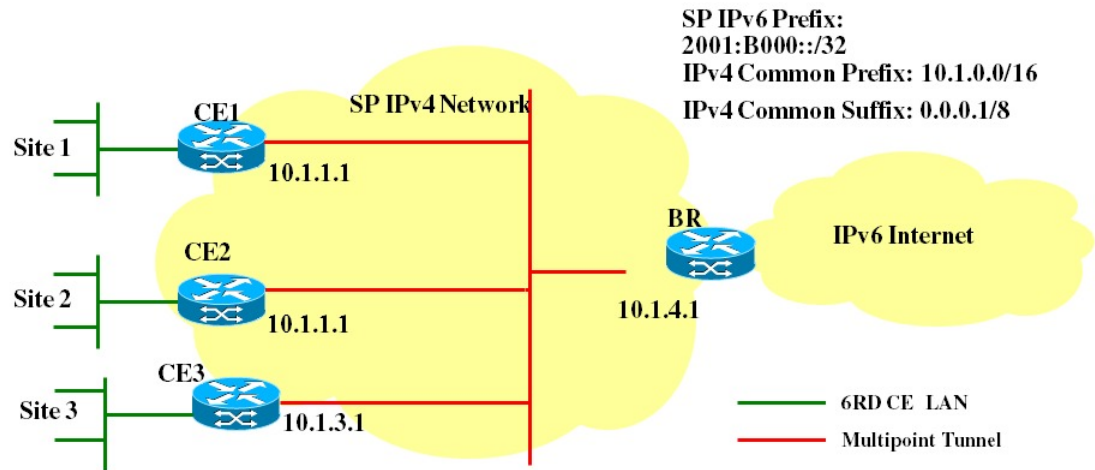

SP Prefix	2001:B000::/32
IPv4 Common Prefix	10.1.0.0/16
IPv4 Common Suffix	0.0.0.1/8
CE1: Delegated 6RD prefix	2001:B000:0100::/40
CE2: Delegated 6RD prefix	2001:B000:0200::/40
BR: Delegated 6RD prefix	2001:B000:0400::/40
CE1 (IPv4) tunnel transport source	10.1.1.1
CE2 (IPv4) tunnel transport source	10.1.2.1
BR (IPv4) tunnel transport source	10.1.4.1

208778

How to Configure IPv6 Rapid Deployment

Configuring 6RD Tunnels

SUMMARY STEPS

1. `enable`
2. `configure terminal`
3. `interface tunnel tunnel-number`
4. `tunnel source {ip-address | interface-t type interface-number}`
5. `tunnel mode ipv6ip [6rd | 6to4 | auto-tunnel | isatap]`
6. `tunnel 6rd prefix ipv6-prefix / prefix-length`
7. `tunnel 6rd ipv4 {prefix-length length} {suffix-length length}`

DETAILED STEPS

	Command or Action	Purpose
Step 1	enable Example: <pre>Router> enable</pre>	Enables privileged EXEC mode. <ul style="list-style-type: none"> • Enter your password if prompted.
Step 2	configure terminal Example: <pre>Router# configure terminal</pre>	Enters global configuration mode.
Step 3	interface tunnel <i>tunnel-number</i> Example: <pre>Router(config)# interface tunnel 1</pre>	Specifies a tunnel interface and number, and enters interface configuration mode.
Step 4	tunnel source {<i>ip-address</i> <i>interface-t type interface-number</i>} Example: <pre>Router(config-if)# tunnel source loopback 1</pre>	Specifies the source interface type and number for the tunnel interface.
Step 5	tunnel mode ipv6ip [6rd 6to4 auto-tunnel isatap] Example: <pre>Router(config-if)# tunnel mode ipv6ip 6rd</pre>	Configures a static IPv6 tunnel interface. <ul style="list-style-type: none"> • The auto-tunnel keyword is not supported on Cisco ASR 1000 series routers.
Step 6	tunnel 6rd prefix <i>ipv6-prefix / prefix-length</i> Example: <pre>Router(config-if)# tunnel 6rd prefix 2001:B000::/32</pre>	Specifies the common IPv6 prefix on IPv6 rapid 6RD tunnels.
Step 7	tunnel 6rd ipv4 {<i>prefix-length length</i>} {<i>suffix-length length</i>} Example: <pre>Router(config-if)# tunnel 6rd ipv4 prefix-length 16 suffix 8</pre>	Specifies the prefix length and suffix length of the IPv4 transport address common to all the 6RD routers in a domain.

Configuration Examples for IPv6 Rapid Deployment

Example: Configuring 6RD Tunnels

The following example shows the running configuration of a 6RD tunnel and the corresponding output of the `show tunnel 6rd` command:

```
interface Tunnell
  ipv6 address 2001:B000:100::1/32
  tunnel source loopback 1
  tunnel mode ipv6ip 6rd
  tunnel 6rd prefix 2001:B000::/32
  tunnel 6rd ipv4 prefix-len 16 suffix-len 8
end
Router# show tunnel 6rd tunnel 1
Interface Tunnell:
  Tunnel Source: 10.1.1.1
  6RD: Operational, V6 Prefix: 2001:B000::/32
  V4 Common Prefix Length: 16, Value: 10.1.0.0
  V4 Common Suffix Length: 8, Value: 0.0.0.1
```

Additional References

Related Documents

Related Topic	Document Title
IPv6 addressing and connectivity	IPv6 Configuration Guide
Cisco IOS commands	Cisco IOS Master Commands List, All Releases
IPv6 commands	Cisco IOS IPv6 Command Reference
Cisco IOS IPv6 features	Cisco IOS IPv6 Feature Mapping

Standards and RFCs

Standard/RFC	Title
RFCs for IPv6	IPv6 RFCs

Technical Assistance

Description	Link
The Cisco Support and Documentation website provides online resources to download documentation, software, and tools. Use these resources to install and configure the software and to troubleshoot and resolve technical issues with Cisco products and technologies. Access to most tools on the Cisco Support and Documentation website requires a Cisco.com user ID and password.	http://www.cisco.com/cisco/web/support/index.html

Feature Information for IPv6 Rapid Deployment

The following table provides release information about the feature or features described in this module. This table lists only the software release that introduced support for a given feature in a given software release train. Unless noted otherwise, subsequent releases of that software release train also support that feature.

Use Cisco Feature Navigator to find information about platform support and Cisco software image support. To access Cisco Feature Navigator, go to www.cisco.com/go/cfn. An account on Cisco.com is not required.

Table 15: Feature Information for IPv6 Rapid Deployment

Feature Name	Releases	Feature Information
IP Tunneling: 6RD IPv6 Rapid Deployment	Cisco IOS XE Release 3.1S	<p>The 6RD feature allows a service provider to provide a unicast IPv6 service to customers over its IPv4 network by using encapsulation of IPv6 in IPv4.</p> <p>The following commands were introduced or modified: tunnel 6rd ipv4, tunnel 6rd prefix, tunnel mode ipv6ip, tunnel source.</p>



CHAPTER 15

IPv6 Automatic 6to4 Tunnels

This feature provides support for IPv6 automatic 6to4 tunnels. An automatic 6to4 tunnel allows isolated IPv6 domains to be connected over an IPv4 network to remote IPv6 networks.

- [Finding Feature Information, on page 139](#)
- [Information About IPv6 Automatic 6to4 Tunnels, on page 139](#)
- [How to Configure IPv6 Automatic 6to4 Tunnels, on page 140](#)
- [Configuration Examples for IPv6 Automatic 6to4 Tunnels, on page 142](#)
- [Additional References, on page 142](#)
- [Feature Information for IPv6 Automatic 6to4 Tunnels, on page 143](#)

Finding Feature Information

Your software release may not support all the features documented in this module. For the latest caveats and feature information, see [Bug Search Tool](#) and the release notes for your platform and software release. To find information about the features documented in this module, and to see a list of the releases in which each feature is supported, see the feature information table.

Use Cisco Feature Navigator to find information about platform support and Cisco software image support. To access Cisco Feature Navigator, go to www.cisco.com/go/cfn. An account on Cisco.com is not required.

Information About IPv6 Automatic 6to4 Tunnels

Automatic 6to4 Tunnels

An automatic 6to4 tunnel allows isolated IPv6 domains to be connected over an IPv4 network to remote IPv6 networks. The key difference between automatic 6to4 tunnels and manually configured tunnels is that the tunnel is not point-to-point; it is point-to-multipoint. In automatic 6to4 tunnels, routers are not configured in pairs because they treat the IPv4 infrastructure as a virtual nonbroadcast multiaccess (NBMA) link. The IPv4 address embedded in the IPv6 address is used to find the other end of the automatic tunnel.

An automatic 6to4 tunnel may be configured on a border router in an isolated IPv6 network, which creates a tunnel on a per-packet basis to a border router in another IPv6 network over an IPv4 infrastructure. The tunnel destination is determined by the IPv4 address of the border router extracted from the IPv6 address that starts with the prefix 2002::/16, where the format is 2002:*border-router-IPv4-address*::/48. Following the embedded IPv4 address are 16 bits that can be used to number networks within the site. The border router at each end

of a 6to4 tunnel must support both the IPv4 and IPv6 protocol stacks. 6to4 tunnels are configured between border routers or between a border router and a host.

The simplest deployment scenario for 6to4 tunnels is to interconnect multiple IPv6 sites, each of which has at least one connection to a shared IPv4 network. This IPv4 network could be the global Internet or a corporate backbone. The key requirement is that each site have a globally unique IPv4 address; the Cisco software uses this address to construct a globally unique 6to4/48 IPv6 prefix. As with other tunnel mechanisms, appropriate entries in a Domain Name System (DNS) that map between hostnames and IP addresses for both IPv4 and IPv6 allow the applications to choose the required address.

How to Configure IPv6 Automatic 6to4 Tunnels

Configuring Automatic 6to4 Tunnels

Before you begin

With 6to4 tunnels, the tunnel destination is determined by the border router IPv4 address, which is concatenated to the prefix 2002::/16 in the format `2002:border-router-IPv4-address::/48`. The border router at each end of a 6to4 tunnel must support both the IPv4 and IPv6 protocol stacks.



Note

The configuration of only one IPv4-compatible tunnel and one 6to4 IPv6 tunnel is supported on a router. If you choose to configure both of those tunnel types on the same router, we strongly recommend that they do not share the same tunnel source.

The reason that a 6to4 tunnel and an IPv4-compatible tunnel cannot share an interface is that both of them are NBMA "point-to-multipoint" access links and only the tunnel source can be used to reorder the packets from a multiplexed packet stream into a single packet stream for an incoming interface. So when a packet with an IPv4 protocol type of 41 arrives on an interface, that packet is mapped to an IPv6 tunnel interface based on the IPv4 address. However, if both the 6to4 tunnel and the IPv4-compatible tunnel share the same source interface, the router is not able to determine the IPv6 tunnel interface to which it should assign the incoming packet.

IPv6 manually configured tunnels can share the same source interface because a manual tunnel is a "point-to-point" link, and both the IPv4 source and IPv4 destination of the tunnel are defined.

>

SUMMARY STEPS

1. **enable**
2. **configure terminal**
3. **interface tunnel** *tunnel-number*
4. **ipv6 address** {*ipv6-address / prefix-length* | *prefix-name sub-bits/prefix-length*}
5. **tunnel source** {*ip-address* | *interface-type interface-number*}
6. **tunnel mode ipv6ip** [**6rd** | **6to4** | **auto-tunnel** | **isatap**]
7. **exit**

8. **ipv6 route** [*vrf vrf-name*] *ipv6-prefix / prefix-length* {*ipv6-address* | *interface-type interface-number* [*ipv6-address*]} [**next-hop-vrf** [*vrf-name1* | **default**]] [*administrative-distance*] [*administrative-multicast-distance* | **unicast** | **multicast**] [*next-hop-address*] [**tag tag**]

DETAILED STEPS

	Command or Action	Purpose
Step 1	<p>enable</p> <p>Example:</p> <pre>Router> enable</pre>	<p>Enables privileged EXEC mode.</p> <ul style="list-style-type: none"> • Enter your password if prompted.
Step 2	<p>configure terminal</p> <p>Example:</p> <pre>Router# configure terminal</pre>	<p>Enters global configuration mode.</p>
Step 3	<p>interface tunnel <i>tunnel-number</i></p> <p>Example:</p> <pre>Router(config)# interface tunnel 1</pre>	<p>Specifies a tunnel interface and number, and enters interface configuration mode.</p>
Step 4	<p>ipv6 address {<i>ipv6-address / prefix-length</i> <i>prefix-name sub-bits/prefix-length</i>}</p> <p>Example:</p> <pre>Router(config-if)# ipv6 address 3ffe:b00:c18:1::3/127</pre>	<p>Specifies the IPv6 network assigned to the interface and enables IPv6 processing on the interface.</p>
Step 5	<p>tunnel source {<i>ip-address</i> <i>interface-type interface-number</i>}</p> <p>Example:</p> <pre>Router(config-if)# tunnel source loopback 1</pre>	<p>Specifies the source interface type and number for the tunnel interface.</p>
Step 6	<p>tunnel mode ipv6ip [6rd 6to4 auto-tunnel isatap]</p> <p>Example:</p> <pre>Router(config-if)# tunnel mode ipv6ip 6rd</pre>	<p>Configures a static IPv6 tunnel interface.</p> <ul style="list-style-type: none"> • The auto-tunnel keyword is not supported on Cisco ASR 1000 series routers.
Step 7	<p>exit</p> <p>Example:</p> <pre>Router(config-if) exit</pre>	<p>Exits interface configuration mode, and enters global configuration mode.</p>
Step 8	<p>ipv6 route [<i>vrf vrf-name</i>] <i>ipv6-prefix / prefix-length</i> {<i>ipv6-address</i> <i>interface-type interface-number</i> [<i>ipv6-address</i>]} [next-hop-vrf [<i>vrf-name1</i> default]]</p>	<p>Configures a static route for the IPv6 6to4 prefix 2002::/16 to the specified tunnel interface.</p>

Command or Action	Purpose
<p>[<i>administrative-distance</i>] [<i>administrative-multicast-distance</i>] unicast multicast] [<i>next-hop-address</i>] [tag tag]</p> <p>Example:</p> <pre>Router(config)# ipv6 route 2002::/16 tunnel 0</pre>	<p>Note When configuring a 6to4 overlay tunnel, you must configure a static route for the IPv6 6to4 prefix 2002::/16 to the 6to4 tunnel interface.</p> <ul style="list-style-type: none"> The tunnel number specified in the ipv6 route command must be the same tunnel number specified in the interface tunnel command.

Configuration Examples for IPv6 Automatic 6to4 Tunnels

Example: Configuring 6to4 Tunnels

The following example configures a 6to4 tunnel on a border router in an isolated IPv6 network. The IPv4 address is 192.168.99.1, which translates to the IPv6 prefix of 2002:c0a8:6301::/48. The IPv6 prefix is subnetted into 2002:c0a8:6301::/64 for the tunnel interface: 2002:c0a8:6301:1::/64 for the first IPv6 network, and 2002:c0a8:6301:2::/64 for the second IPv6 network. The static route ensures that any other traffic for the IPv6 prefix 2002::/16 is directed to tunnel interface 0 for automatic tunneling.

```
interface GigabitEthernet0/0/0
  description IPv4 uplink
  ip address 192.168.99.1 255.255.255.0
  !
interface GigabitEthernet1/0/0
  description IPv6 local network 1
  ipv6 address 2002:c0a8:6301:1::1/64
  !
interface GigabitEthernet2/0/0
  description IPv6 local network 2
  ipv6 address 2002:c0a8:6301:2::1/64
  !
interface Tunnel0
  description IPv6 uplink
  no ip address
  ipv6 address 2002:c0a8:6301::1/64
  tunnel source GigabitEthernet0/0/0
  tunnel mode ipv6ip 6to4
  !
ipv6 route 2002::/16 tunnel 0
```

Additional References

Related Documents

Related Topic	Document Title
IPv6 addressing and connectivity	<i>IPv6 Configuration Guide</i>

Related Topic	Document Title
Cisco IOS commands	Cisco IOS Master Commands List, All Releases
IPv6 commands	Cisco IOS IPv6 Command Reference
Cisco IOS IPv6 features	Cisco IOS IPv6 Feature Mapping

Standards and RFCs

Standard/RFC	Title
RFCs for IPv6	<i>IPv6 RFCs</i>

MIBs

MIB	MIBs Link
	To locate and download MIBs for selected platforms, Cisco IOS releases, and feature sets, use Cisco MIB Locator found at the following URL: <i>http://www.cisco.com/go/mibs</i>

Technical Assistance

Description	Link
The Cisco Support and Documentation website provides online resources to download documentation, software, and tools. Use these resources to install and configure the software and to troubleshoot and resolve technical issues with Cisco products and technologies. Access to most tools on the Cisco Support and Documentation website requires a Cisco.com user ID and password.	http://www.cisco.com/cisco/web/support/index.html

Feature Information for IPv6 Automatic 6to4 Tunnels

The following table provides release information about the feature or features described in this module. This table lists only the software release that introduced support for a given feature in a given software release train. Unless noted otherwise, subsequent releases of that software release train also support that feature.

Use Cisco Feature Navigator to find information about platform support and Cisco software image support. To access Cisco Feature Navigator, go to www.cisco.com/go/cfn. An account on Cisco.com is not required.

Table 16: Feature Information for IPv6 Automatic 6to4 Tunnels

Feature Name	Releases	Feature Information
IPv6 Tunneling: Automatic 6to4 Tunnels	Cisco IOS XE Release 2.1	<p>An automatic 6to4 tunnel allows isolated IPv6 domains to be connected over an IPv4 network to remote IPv6 networks.</p> <p>The following commands were introduced or modified: tunnel mode ipv6ip, tunnel source.</p>



CHAPTER 16

IPv6 over IPv4 GRE Tunnels

GRE tunnels are links between two points, with a separate tunnel for each link. The tunnels are not tied to a specific passenger or transport protocol, but in this case carry IPv6 as the passenger protocol with the GRE as the carrier protocol and IPv4 or IPv6 as the transport protocol.

- [Finding Feature Information, on page 145](#)
- [Information About IPv6 over IPv4 GRE Tunnels, on page 145](#)
- [How to Configure IPv6 over IPv4 GRE Tunnels, on page 148](#)
- [Configuration Examples for IPv6 over IPv4 GRE Tunnels, on page 149](#)
- [Additional References, on page 151](#)
- [Feature Information for IPv6 over IPv4 GRE Tunnels, on page 152](#)

Finding Feature Information

Your software release may not support all the features documented in this module. For the latest caveats and feature information, see [Bug Search Tool](#) and the release notes for your platform and software release. To find information about the features documented in this module, and to see a list of the releases in which each feature is supported, see the feature information table.

Use Cisco Feature Navigator to find information about platform support and Cisco software image support. To access Cisco Feature Navigator, go to www.cisco.com/go/cfn. An account on Cisco.com is not required.

Information About IPv6 over IPv4 GRE Tunnels

Overlay Tunnels for IPv6

Overlay tunneling encapsulates IPv6 packets in IPv4 packets for delivery across an IPv4 infrastructure (a core network or the figure below). By using overlay tunnels, you can communicate with isolated IPv6 networks without upgrading the IPv4 infrastructure between them. Overlay tunnels can be configured between border devices or between a border device and a host; however, both tunnel endpoints must support both the IPv4 and IPv6 protocol stacks. IPv6 supports the following types of overlay tunneling mechanisms:

- Manual
- Generic routing encapsulation (GRE)

- IPv4-compatible
- 6to4
- Intrasite Automatic Tunnel Addressing Protocol (ISATAP)

Figure 7: Overlay Tunnels

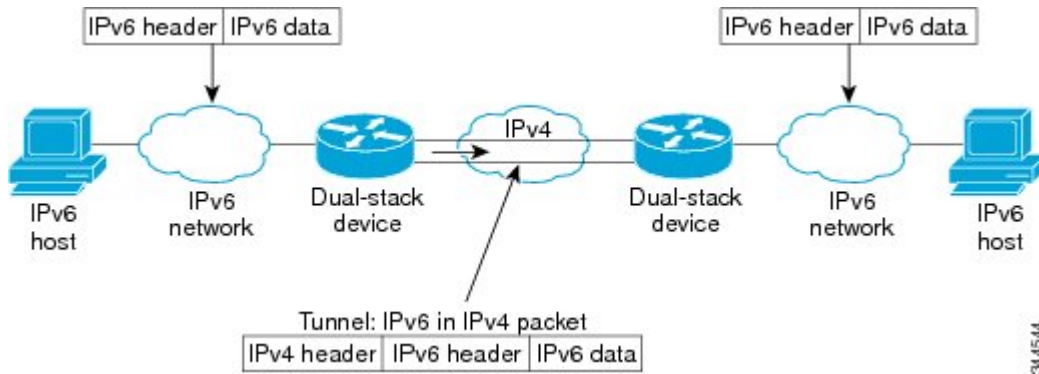

Note Overlay tunnels reduce the maximum transmission unit (MTU) of an interface by 20 octets (assuming that the basic IPv4 packet header does not contain optional fields). A network that uses overlay tunnels is difficult to troubleshoot. Therefore, overlay tunnels that connect isolated IPv6 networks should not be considered a final IPv6 network architecture. The use of overlay tunnels should be considered as a transition technique toward a network that supports both the IPv4 and IPv6 protocol stacks or just the IPv6 protocol stack.

Use the table below to help you determine which type of tunnel that you want to configure to carry IPv6 packets over an IPv4 network.

Table 17: Suggested Usage of Tunnel Types to Carry IPv6 Packets over an IPv4 Network

Tunneling Type	Suggested Usage	Usage Notes
Manual	Simple point-to-point tunnels that can be used within a site or between sites.	Can carry IPv6 packets only.
GRE- and IPv4-compatible	Simple point-to-point tunnels that can be used within a site or between sites.	Can carry IPv6, Connectionless Network Service (CLNS), and many other types of packets.
IPv4-compatible	Point-to-multipoint tunnels.	Uses the ::/96 prefix. We do not recommend using this tunnel type.
6to4	Point-to-multipoint tunnels that can be used to connect isolated IPv6 sites.	Sites use addresses from the 2002::/16 prefix.
6RD	IPv6 service is provided to customers over an IPv4 network by using encapsulation of IPv6 in IPv4.	Prefixes can be from the SP's own address block.

Tunneling Type	Suggested Usage	Usage Notes
ISATAP	Point-to-multipoint tunnels that can be used to connect systems within a site.	Sites can use any IPv6 unicast addresses.

Individual tunnel types are discussed in detail in this document. We recommend that you review and understand the information about the specific tunnel type that you want to implement. When you are familiar with the type of tunnel you need, see the table below for a summary of the tunnel configuration parameters that you may find useful.

Table 18: Tunnel Configuration Parameters by Tunneling Type

Tunneling Type	Tunnel Configuration Parameter			
Tunnel Mode	Tunnel Source	Tunnel Destination	Interface Prefix or Address	
Manual	ipv6ip	An IPv4 address, or a reference to an interface on which IPv4 is configured.	An IPv4 address.	An IPv6 address.
GRE/IPv4	gre ip		An IPv4 address.	An IPv6 address.
IPv4- compatible	ipv6ip auto-tunnel		Not required. These are all point-to-multipoint tunneling types. The IPv4 destination address is calculated, on a per-packet basis, from the IPv6 destination.	Not required. The interface address is generated as <code>::tunnel-source/96</code> .
6to4	ipv6ip 6to4		An IPv6 address. The prefix must embed the tunnel source IPv4 address.	
6RD	ipv6ip 6rd		An IPv6 address.	
ISATAP	ipv6ip isatap		An IPv6 prefix in modified eui-64 format. The IPv6 address is generated from the prefix and the tunnel source IPv4 address.	

GRE IPv4 Tunnel Support for IPv6 Traffic

IPv6 traffic can be carried over IPv4 GRE tunnels using the standard GRE tunneling technique that is designed to provide the services to implement any standard point-to-point encapsulation scheme. As in IPv6 manually configured tunnels, GRE tunnels are links between two points, with a separate tunnel for each link. The tunnels are not tied to a specific passenger or transport protocol but, in this case, carry IPv6 as the passenger protocol with the GRE as the carrier protocol and IPv4 or IPv6 as the transport protocol.

The primary use of GRE tunnels is for stable connections that require regular secure communication between two edge devices or between an edge device and an end system. The edge devices and the end systems must be dual-stack implementations.

How to Configure IPv6 over IPv4 GRE Tunnels

Configuring GRE on IPv6 Tunnels

GRE tunnels can be configured to run over an IPv6 network layer and to transport IPv4 and IPv6 packets in IPv6 tunnels.

Before you begin

When GRE IPv6 tunnels are configured, IPv6 addresses are assigned to the tunnel source and the tunnel destination. The tunnel interface can have either IPv4 addresses or IPv6 addresses assigned (this is not shown in the task). The host or device at each end of a configured tunnel must support both the IPv4 and IPv6 protocol stacks.

SUMMARY STEPS

1. **enable**
2. **configure terminal**
3. **interface tunnel *tunnel-number***
4. Enter one of the following commands:
 - **ipv6 address** {*ipv6-address/prefix-length* | *prefix-name sub-bits/prefix-length*}
 - **ipv6 address** *ipv6-prefix/prefix-length* [**eui-64**]
5. **tunnel source** {*ip-address* | *ipv6-address* | *interface-type interface-number*}
6. **tunnel destination** {*hostname* | *ip-address* | *ipv6-address*}
7. **tunnel mode** {**aurp** | **cayman** | **dvmrp** | **eon** | **gre** | **gre multipoint** | **gre ipv6** | **ipip** [**decapsulate-any**] | **iptalk** | **ipv6** | **mpls** | **nos**}
8. **end**

DETAILED STEPS

	Command or Action	Purpose
Step 1	enable Example: Device> enable	Enables privileged EXEC mode. <ul style="list-style-type: none"> • Enter your password if prompted.
Step 2	configure terminal Example: Device# configure terminal	Enters global configuration mode.
Step 3	interface tunnel <i>tunnel-number</i> Example: Device(config)# interface tunnel 0	Specifies a tunnel interface and number, and enters interface configuration mode.

	Command or Action	Purpose
Step 4	Enter one of the following commands: <ul style="list-style-type: none"> • ipv6 address {<i>ipv6-address/prefix-length</i> <i>prefix-name sub-bits/prefix-length</i>} • ipv6 address <i>ipv6-prefix/prefix-length</i> [eui-64] Example: <pre>Device(config-if)# ipv6 address 3ffe:b00:c18:1::3/127</pre>	Specifies the IPv6 network assigned to the interface and enables IPv6 processing on the interface. <ul style="list-style-type: none"> • If you specify the eui-64 keyword, the software configures an IPv6 address for an interface and enables IPv6 processing on the interface using an EUI-64 interface ID in the low-order 64 bits of the address.
Step 5	tunnel source { <i>ip-address</i> <i>ipv6-address</i> <i>interface-type interface-number</i> } Example: <pre>Device(config-if)# tunnel source gigabitethernet 0/0/0</pre>	Specifies the source IPv4 address, IPv6 address, or the source interface type and number for the tunnel interface. <ul style="list-style-type: none"> • If an interface is specified, the interface must be configured with an IPv4 address.
Step 6	tunnel destination { <i>hostname</i> <i>ip-address</i> <i>ipv6-address</i> } Example: <pre>Device(config-if)# tunnel destination 2001:DB8:1111:2222::1/64</pre>	Specifies the destination IPv4 address, IPv6 address, or hostname for the tunnel interface.
Step 7	tunnel mode { aurp cayman dvmrp eon gre gre multipoint gre ipv6 ipip [decapsulate-any] iptalk ipv6 mpls nos } Example: <pre>Device(config-if)# tunnel mode gre ipv6</pre>	Specifies a GRE IPv6 tunnel. Note The tunnel mode gre ipv6 command specifies GRE as the encapsulation protocol for the tunnel.
Step 8	end Example: <pre>Device(config-if)# end</pre>	Returns to privileged EXEC mode.

Configuration Examples for IPv6 over IPv4 GRE Tunnels

Example GRE Tunnel Running IS-IS and IPv6 Traffic

The following example configures a GRE tunnel running both IS-IS and IPv6 traffic between Router A and Router B:

Router A Configuration

```
ipv6 unicast-routing
clns routing
```

Example: Tunnel Destination Address for IPv6 Tunnel

```

!
interface tunnel 0
 no ip address
 ipv6 address 3ffe:b00:c18:1::3/127
 ipv6 router isis
 tunnel source GigabitEthernet 0/0/0
 tunnel destination 2001:DB8:1111:2222::1/64
 tunnel mode gre ipv6
!
interface GigabitEthernet0/0/0
 ip address 10.0.0.1 255.255.255.0
!
router isis
 net 49.0000.0000.000a.00

```

Router B Configuration

```

ipv6 unicast-routing
 clns routing
!
interface tunnel 0
 no ip address
 ipv6 address 3ffe:b00:c18:1::2/127
 ipv6 router isis
 tunnel source GigabitEthernet 0/0/0
 tunnel destination 2001:DB8:1111:2222::2/64
 tunnel mode gre ipv6
!
interface GigabitEthernet0/0/0
 ip address 10.0.0.2 255.255.255.0
!
router isis
 net 49.0000.0000.000b.00
 address-family ipv6
 redistribute static
 exit-address-family

```

Example: Tunnel Destination Address for IPv6 Tunnel

```

Router(config
)
#
interface Tunnel0
Router(config
-if)
#
ipv6 address 2001:1:1::1/48
Router(config
-if)
#
tunnel source GigabitEthernet 0/0/0
Router(config
-if)
#
tunnel destination 10.0.0.2
Router(config
-if)
#
tunnel mode gre ipv6
Router(config

```

```

-if)
#
exit
!
Router(config
)
#
interface GigabitEthernet0/0/0
Router(config
-if)
#
ip address 10.0.0.1 255.255.255.0
Router(config
-if)
#
exit
!
Router(config
)
#
ipv6 unicast-routing
Router(config
)
#
router isis

Router(config
)
#
net 49.0000.0000.000a.00

```

Additional References

Related Documents

Related Topic	Document Title
IPv6 addressing and connectivity	<i>IPv6 Configuration Guide</i>
Cisco IOS commands	<i>Cisco IOS Master Commands List, All Releases</i>
IPv6 commands	<i>Cisco IOS IPv6 Command Reference</i>
Cisco IOS IPv6 features	<i>Cisco IOS IPv6 Feature Mapping</i>

Standards and RFCs

Standard/RFC	Title
RFCs for IPv6	<i>IPv6 RFCs</i>

MIBs

MIB	MIBs Link
	To locate and download MIBs for selected platforms, Cisco IOS releases, and feature sets, use Cisco MIB Locator found at the following URL: <i>http://www.cisco.com/go/mibs</i>

Technical Assistance

Description	Link
The Cisco Support and Documentation website provides online resources to download documentation, software, and tools. Use these resources to install and configure the software and to troubleshoot and resolve technical issues with Cisco products and technologies. Access to most tools on the Cisco Support and Documentation website requires a Cisco.com user ID and password.	<i>http://www.cisco.com/cisco/web/support/index.html</i>

Feature Information for IPv6 over IPv4 GRE Tunnels

The following table provides release information about the feature or features described in this module. This table lists only the software release that introduced support for a given feature in a given software release train. Unless noted otherwise, subsequent releases of that software release train also support that feature.

Use Cisco Feature Navigator to find information about platform support and Cisco software image support. To access Cisco Feature Navigator, go to www.cisco.com/go/cfn. An account on Cisco.com is not required.

Table 19: Feature Information for IPv6 over IPv4 GRE Tunnels

Feature Name	Releases	Feature Information
IPv6 over IPv4 GRE Tunnels	Cisco IOS XE Release 2.1	GRE tunnels are links between two points, with a separate tunnel for each link. The tunnels are not tied to a specific passenger or transport protocol, but in this case carry IPv6 as the passenger protocol with the GRE as the carrier protocol and IPv4 or IPv6 as the transport protocol. The following commands were introduced or modified: tunnel destination , tunnel mode ipv6ip , tunnel source .



CHAPTER 17

GRE IPv6 Tunnels

The GRE IPv6 Tunnels feature enables the delivery of packets from other protocols through an IPv6 network and allows the routing of IPv6 packets between private networks across public networks with globally routed IPv6 addresses. Generic routing encapsulation (GRE) is a unicast protocol that offers the advantages of encapsulating broadcast and multicast traffic (multicast streaming or routing protocols) or other non-IP protocols and of being protected by IPsec.

- [Finding Feature Information, on page 153](#)
- [Restrictions for GRE IPv6 Tunnels, on page 153](#)
- [Information About GRE IPv6 Tunnels, on page 154](#)
- [How to Configure GRE IPv6 Tunnels, on page 154](#)
- [Configuration Examples for GRE IPv6 Tunnels, on page 157](#)
- [Information About EoMPLS over IPv6 GRE Tunnel, on page 157](#)
- [Additional References, on page 165](#)
- [Feature Information for GRE IPv6 Tunnels, on page 165](#)

Finding Feature Information

Your software release may not support all the features documented in this module. For the latest caveats and feature information, see [Bug Search Tool](#) and the release notes for your platform and software release. To find information about the features documented in this module, and to see a list of the releases in which each feature is supported, see the feature information table.

Use Cisco Feature Navigator to find information about platform support and Cisco software image support. To access Cisco Feature Navigator, go to www.cisco.com/go/cfn. An account on Cisco.com is not required.

Restrictions for GRE IPv6 Tunnels

- GRE tunnel keepalive packets are not supported.
- Multipoint GRE (mGRE) IPv6 tunneling is not supported.

Information About GRE IPv6 Tunnels

Overview of GRE IPv6 Tunnels

The GRE IPv6 Tunnels feature enables the delivery of packets from other protocols through an IPv6 network and allows the routing of IPv6 packets between private networks across public networks with globally routed IPv6 addresses.

For point-to-point GRE tunnels, each tunnel interface requires a tunnel source IPv6 address and a tunnel destination IPv6 address when being configured. All packets are encapsulated with an outer IPv6 header and a GRE header.

GRE IPv6 Tunnel Protection

GRE IPv6 tunnel protection allows devices to work as security gateways, establish IPsec tunnels between other security gateway devices, and provide crypto IPsec protection for traffic from internal networks when the traffic is sent across the public IPv6 Internet. The GRE IPv6 tunnel protection functionality is similar to the security gateway model that uses GRE IPv4 tunnel protection.

How to Configure GRE IPv6 Tunnels

Configuring GRE IPv6 Tunnels

Perform this task to configure a GRE tunnel on an IPv6 network. GRE tunnels can be configured to run over an IPv6 network layer and transport IPv6 and IPv4 packets through IPv6 tunnels.



Note You must enable IPv6 or configure IPv6 MTU size more than 1500 on a tunnel's exit interface to avoid receiving warning messages.

Before you begin

When GRE IPv6 tunnels are configured, IPv6 addresses are assigned to the tunnel source and the tunnel destination. The tunnel interface can have either IPv4 or IPv6 addresses. The host or device at each end of the configured tunnel must support both IPv4 and IPv6 protocol stacks.

Procedure

	Command or Action	Purpose
Step 1	enable Example: Device> enable	Enables privileged EXEC mode. <ul style="list-style-type: none"> • Enter your password if prompted.

	Command or Action	Purpose
Step 2	configure terminal Example: Device# configure terminal	Enters global configuration mode.
Step 3	interface tunnel <i>tunnel-number</i> Example: Device(config)# interface tunnel 0	Specifies a tunnel interface and number and enters interface configuration mode.
Step 4	tunnel source {<i>ipv6-address</i> <i>interface-type</i> <i>interface-number</i> } Example: Device(config-if)# tunnel source ethernet 0	Specifies the source IPv6 address or the source interface type and number for the tunnel interface. • If an interface type and number are specified, the interface must be configured with an IPv6 address. Note For more information on the tunnel source command, refer to the IPv6 command reference guide.
Step 5	tunnel destination <i>ipv6-address</i> Example: Device(config-if)# tunnel destination 2001:0DB8:0C18:2::300	Specifies the destination IPv6 address for the tunnel interface. Note For more information on the tunnel destination command, refer to the IPv6 command reference guide.
Step 6	tunnel mode gre ipv6 Example: Device(config-if)# tunnel mode gre ipv6	Specifies a GRE IPv6 tunnel. Note The tunnel mode gre ipv6 command specifies GRE as the encapsulation protocol for the tunnel interface. Only the syntax used in this context is displayed. For more details, see the IPv6 Command Reference .
Step 7	end Example: Device(config-if)# end	Exits interface configuration mode and returns to privileged EXEC mode.

Configuring GRE IPv6 Tunnel Protection

SUMMARY STEPS

1. **enable**
2. **configure terminal**
3. **interface tunnel *tunnel-number***
4. **tunnel source {*ipv6-address* | *interface-type* *interface-number*}**
5. **tunnel destination *ipv6-address***
6. **tunnel mode gre ipv6**

7. **tunnel protection ipsec profile** *profile-name*
8. **end**

DETAILED STEPS

	Command or Action	Purpose
Step 1	enable Example: Device> enable	Enables privileged EXEC mode. <ul style="list-style-type: none">• Enter your password if prompted.
Step 2	configure terminal Example: Device# configure terminal	Enters global configuration mode.
Step 3	interface tunnel <i>tunnel-number</i> Example: Device(config)# interface tunnel 0	Specifies a tunnel interface and number and enters interface configuration mode.
Step 4	tunnel source { <i>ipv6-address</i> <i>interface-type interface-number</i> } Example: Device(config-if)# tunnel source ethernet 0	Specifies the source IPv6 address or the source interface type and number for the tunnel interface. <ul style="list-style-type: none">• If an interface type and number are specified, the interface must be configured with an IPv6 address. Note Only the syntax used in this context is displayed. For more details, see the IPv6 Command Reference .
Step 5	tunnel destination <i>ipv6-address</i> Example: Device(config-if)# tunnel destination 2001:0DB8:0C18:2::300	Specifies the destination IPv6 address for the tunnel interface. Note Only the syntax used in this context is displayed. For more details, see the IPv6 Command Reference .
Step 6	tunnel mode gre ipv6 Example: Device(config-if)# tunnel mode gre ipv6	Specifies a GRE IPv6 tunnel. Note The tunnel mode gre ipv6 command specifies GRE as the encapsulation protocol for the tunnel interface. Only the syntax used in this context is displayed. For more details, see the IPv6 Command Reference .
Step 7	tunnel protection ipsec profile <i>profile-name</i> Example: Device(config-if)# tunnel protection ipsec profile ipsec-profile	Associates the tunnel interface with an IPsec profile. Note For the <i>profile-name</i> argument, specify the IPsec profile configured in global configuration mode.

	Command or Action	Purpose
Step 8	end Example: Device(config-if)# end	Exits interface configuration mode and returns to privileged EXEC mode.

Configuration Examples for GRE IPv6 Tunnels

Example: Configuring GRE IPv6 Tunnels

The following example shows how to configure a GRE tunnel over an IPv6 transport. In this example, Ethernet0/0 has an IPv6 address, and this is the source address used by the tunnel interface. The destination IPv6 address of the tunnel is specified directly. In this example, the tunnel carries both IPv4 and IS-IS traffic.

```
interface Tunnel0
 ip address 10.1.1.1 255.255.255.0
 ip router isis
 tunnel source Ethernet0/0
 tunnel destination 2001:DB8:1111:2222::1
 tunnel mode gre ipv6
 !
interface Ethernet0/0
 no ip address
 ipv6 address 2001:DB8:1111:1111::1/64
 !
router isis
 net 49.0001.0000.0000.000a.00
```

Example: Configuring GRE IPv6 Tunnel Protection

The following example shows how to associate the IPsec profile “ipsec-profile” with a GRE IPv6 tunnel interface. The IPsec profile is configured using the **crypto ipsec profile** command.

```
crypto ipsec profile ipsec-profile
 set transform-set ipsec-profile
 !
interface Tunnel1
 ip address 192.168.1.1 255.255.255.252
 tunnel source FastEthernet2/0
 tunnel destination 10.13.7.67
 tunnel protection ipsec profile ipsec-profile
```

Information About EoMPLS over IPv6 GRE Tunnel

Ethernet over MPLS (EoMPLS) is a tunneling mechanism that allows you to tunnel Layer 2 traffic through a Layer 3 MPLS network. EoMPLS is also known as Layer 2 tunneling.

The EoMPLS over IPv6 GRE Tunnel feature supports tunneling of EoMPLS traffic via an IPv6 network by using GRE tunnels. Effective from Cisco IOS XE Release 3.15s, EoMPLS is supported over IPv6 GRE tunnel.

The following figure shows a deployment model of the EoMPLS over IPv6 GRE Tunnel on a Cisco ASR 1000 Series Aggregation Services Router.

Figure 8: EoMPLS over IPv6 GRE Tunnel Deployment on a Cisco ASR 1000 Series Aggregation Services Router

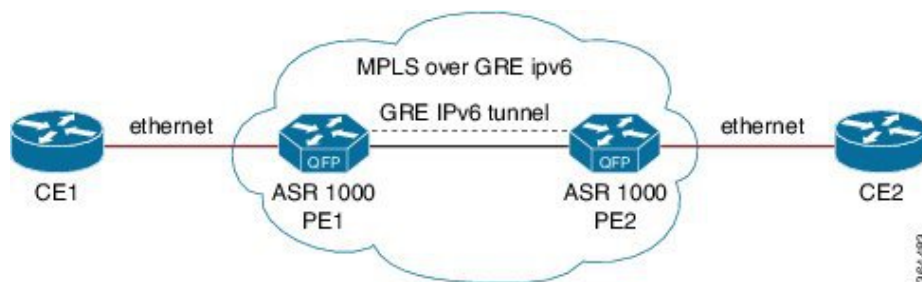

Configuring EoMPLS over IPv6 GRE Tunnel

EoMPLS over IPv6 GRE Tunnel can be configured in the following two methods:

[Using Legacy Commands, on page 158](#)

[Using Protocol-based Commands, on page 160](#)

Using Legacy Commands

This section describes how to configure EoMPLS over IPv6 GRE Tunnel using legacy commands. The following are relevant configurations from both Provider Edge 1 Router and Provider Edge 2 Router:

SUMMARY STEPS

1. configure terminal
2. ipv6 unicast-routing
3. mpls label protocol ldp
4. mpls ldp router-id Loopback0 [force]
5. interface *type number*
6. ip address *ip-address mask*
7. interface gigabitethernet slot/port
8. encapsulation dot1 *vlan-id*
9. xconnect *peer-ipaddress vc-id* encapsulation mpls
10. interface tunnel *interface number*
11. ip address *ip-address mask*
12. tunnel source {*ip-address* | *interface-type interface-number*}
13. tunnel mode gre ipv6
14. tunnel destination *ipv6-address*
15. mpls ip
16. interface gigabitethernet slot/port
17. ipv6 address { *ipv6-prefix/prefix-length* | *prefix-name sub-bits/prefix-length* }

DETAILED STEPS

	Command or Action	Purpose
Step 1	configure terminal Example: Router#configure terminal	Enters global configuration mode.
Step 2	ipv6 unicast-routing Example: Router(config)#ipv6 unicast-routing	Enables the forwarding of IPv6 unicast datagrams globally on the router.
Step 3	mpls label protocol ldp Example: Router(config)#mpls label protocol ldp	Enables Label Distribution Protocol (LDP).
Step 4	mpls ldp router-id Loopback0 [force] Example: Router(config)#mpls ldp router-id Loopback0 [force]	Configures the LDP Router ID. Note The optional force keyword ensures that the IP address on interface loopback 0, and not the IP address of any other interface, becomes the LDP router ID.
Step 5	interface <i>type number</i> Example: Router(config)#interface Loopback 0	Enters configuration mode for the loopback interface.
Step 6	ip address <i>ip-address mask</i> Example: Router(config-if)#ip address 10.1.1.2 255.255.255.255	Sets the IP address and subnet mask for the loopback interface.
Step 7	interface gigabitethernet slot/port Example: Router(config-if)#interface GigabitEthernet0/0/1.2	Enters the configuration mode for a Gigabit Ethernet interface on the router.
Step 8	encapsulation dot1q <i>vlan-id</i> Example: Router(config-subif)#encapsulation dot1q 200	Enables 802.1Q trunking on a router.
Step 9	xconnect <i>peer-ipaddress vc-id encapsulation mpls</i> Example: Router(config-subif)#xconnect 10.1.1.1 100 encapsulation mpls	Enables the attachment circuit and specifies the IP address of the peer, a VC ID, and the data encapsulation method.
Step 10	interface tunnel <i>interface number</i> Example: Router(config)#interface tunnel 10	Designates a tunnel interface and enters interface configuration mode.

	Command or Action	Purpose
Step 11	ip address <i>ip-address mask</i> Example: <pre>Router(config-if)#ip address 41.0.0.1 255.255.255.0</pre>	Sets the IP address and subnet mask for the loopback interface.
Step 12	tunnel source { <i>ip-address</i> <i>interface-type interface-number</i> } Example: <pre>Router(config-if)#tunnel source GigabitEthernet 0/0/0</pre>	Specifies the source IPv4 address or the source interface type and number for the tunnel interface.
Step 13	tunnel mode gre ipv6 Example: <pre>Router (config-if)#tunnel mode gre ipv6</pre>	Specifies that the GRE over IPv6 encapsulation protocol is used in the tunnel.
Step 14	tunnel destination <i>ipv6-address</i> Example: <pre>Router(config-if)#tunnel destination 2002::2</pre>	Specifies the destination IPv6 address for the tunnel interface.
Step 15	mpls ip Example: <pre>Router(config-if)#mpls ip</pre>	Enables mpls processing on the tunnel interface.
Step 16	interface gigabitethernet slot/port Example: <pre>Router(config-if)#interface GigabitEthernet0/0/0</pre>	Enters the configuration mode for a Gigabit Ethernet interface on the router.
Step 17	ipv6 address { <i>ipv6-prefix/prefix-length</i> <i>prefix-name sub-bits/prefix-length</i> } Example: <pre>Router(config-if)#ipv6 address 2002::1/112</pre>	Configures an IPv6 address based on an IPv6 general prefix and enables IPv6 processing on an interface.

Example

Using Protocol-based Commands

This section describes how to configure EoMPLS over IPv6 GRE Tunnel using Protocol-based commands.

SUMMARY STEPS

1. template type pseudowire [*pseudowire-name*]
2. encapsulation mpls
3. end

4. interface pseudowire *number*
5. source template type pseudowire
6. encapsulation mpls
7. neighbor *peer-address vcid-value*
8. end
9. l2vpn xconnect context *context-name*
10. member pseudowire *interface-number*
11. member gigabit ethernet *interface-number*

DETAILED STEPS

	Command or Action	Purpose
Step 1	template type pseudowire [<i>pseudowire-name</i>] Example: Router(config)# template type pseudowire eompls	Specifies the name of a Layer 2 pseudowire class and enters pseudowire class configuration mode.
Step 2	encapsulation mpls Example: Router(config-pw-class)# encapsulation mpls	Specifies the tunneling encapsulation.
Step 3	end Example: Router(config-pw-class)# end	Exits to privileged EXEC mode.
Step 4	interface pseudowire <i>number</i> Example: Router(config)# interface pseudowire 100	Specifies the pseudowire interface and enters interface configuration mode.
Step 5	source template type pseudowire Example: Router(config-if)# source template type pseudowire eompls	Configures the source template of type pseudowire named EoMPLS.
Step 6	encapsulation mpls Example: Router(config-pw-class)# encapsulation mpls	Specifies the tunneling encapsulation.
Step 7	neighbor <i>peer-address vcid-value</i> Example: Router(config-if)# neighbor 154.154.154.154 100	Specifies the peer IP address and virtual circuit (VC) ID value of a Layer 2 VPN (L2VPN) pseudowire.
Step 8	end Example: Router(config-if)# end	Exits to privileged EXEC mode.

	Command or Action	Purpose
Step 9	l2vpn xconnect context <i>context-name</i> Example: Router(config)# l2vpn xconnect context eompls_100	Creates a Layer 2 VPN (L2VPN) cross connect context and enters xconnect configuration mode.
Step 10	member pseudowire <i>interface-number</i> Example: Router(config-xconnect)# member pseudowire 100	Specifies a member pseudowire to form a Layer 2 VPN (L2VPN) cross connect.
Step 11	member gigabit ethernet <i>interface-number</i> Example: Router(config-xconnect)# member GigabitEthernet0/0/1	Specifies the location of the Gigabit Ethernet member interface.

Example

Verifying the EoMPLS over IPv6 GRE Tunnel Configuration

Use the following commands to verify that the EoMPLS over IPv6 GRE Tunnel feature is correctly configured.

SUMMARY STEPS

1. show inter tunnel [*tunnel-id*]
2. show xconnect all [detail]
3. show mpls l2transport vc id detail

DETAILED STEPS

	Command or Action	Purpose
Step 1	show inter tunnel [<i>tunnel-id</i>]	<pre> Router# show inter tunnel10 Tunnel10 is up, line protocol is up Hardware is Tunnel Internet address is 41.0.0.2/24 MTU 1456 bytes, BW 100 Kbit/sec, DLY 50000 usec, reliability 255/255, txload 1/255, rxload 1/255 Encapsulation TUNNEL, loopback not set Keepalive not set Tunnel linstatstate evaluation up Tunnel source 2002::2 (GigabitEthernet0/0/0), destination 2002::1 Tunnel Subblocks: src-track: Tunnel10 source tracking subblock associated with GigabitEthernet0/0/0 Set of tunnels with source GigabitEthernet0/0/0, 1 member (includes iterators), on interface <OK> Tunnel protocol/transport GRE/IPv6 </pre>

	Command or Action	Purpose
		<pre> Key disabled, sequencing disabled Checksumming of packets disabled Tunnel TTL 255 Path MTU Discovery, age 10 mins, min MTU 1280 Tunnel transport MTU 1456 bytes Tunnel transmit bandwidth 8000 (kbps) Tunnel receive bandwidth 8000 (kbps) Last input never, output never, output hang never Last clearing of "show interface" counters 04:41:12 Input queue: 0/375/0/0 (size/max/drops/flushes); Total output drops: 0 Queueing strategy: fifo Output queue: 0/0 (size/max) 30 second input rate 0 bits/sec, 0 packets/sec 30 second output rate 0 bits/sec, 0 packets/sec 8363 packets input, 1074130 bytes, 0 no buffer Received 0 broadcasts (0 IP multicasts) 0 runts, 0 giants, 0 throttles 0 input errors, 0 CRC, 0 frame, 0 overrun, 0 ignored, 0 abort 8384 packets output, 1076628 bytes, 0 underruns 0 output errors, 0 collisions, 0 interface resets 0 unknown protocol drops 0 output buffer failures, 0 output buffers swapped out </pre>
Step 2	show xconnect all [detail]	<pre> Router# show xconnect all Legend: XC ST=Xconnect State S1=Segment1 State S2=Segment2 State UP=Up DN=Down AD=Admin Down IA=Inactive SB=Standby HS=Hot Standby RV=Recovering NH=No Hardware XC ST Segment 1 S1 Segment 2 S2 ----- ----- ----- ----- UP pri ac Gi0/0/0.2:200(Eth VLAN) UP mpls 10.1.1.2:100 UP asr1001#show xconnect all detail Legend: XC ST=Xconnect State S1=Segment1 State S2=Segment2 State UP=Up DN=Down AD=Admin Down IA=Inactive SB=Standby HS=Hot Standby RV=Recovering NH=No Hardware XC ST Segment 1 S1 Segment 2 S2 ----- ----- ----- ----- UP pri ac Gi0/0/0.2:200(Eth VLAN) UP mpls 10.1.1.2:100 UP Interworking: ethernet Local VC label 17 Remote VC label 17 </pre>

	Command or Action	Purpose
Step 3	show mpls l2transport vc id detail	<pre> Router# show mpls l2transport vc 100 detail Local interface: Gi0/0/0.2 up, line protocol up, Eth VLAN 200 up Interworking type is Ethernet Destination address: 10.1.1.2, VC ID: 100, VC status: up Output interface: Tu10, imposed label stack {17} Preferred path: not configured Default path: active Next hop: point2point Create time: 05:52:23, last status change time: 05:52:07 Last label FSM state change time: 05:52:07 Signaling protocol: LDP, peer 10.1.1.2:0 up Targeted Hello: 10.1.1.1(LDP Id) -> 10.1.1.2, LDP is UP Graceful restart: configured and not enabled Non stop routing: not configured and not enabled Status TLV support (local/remote) : enabled/supported LDP route watch : enabled Label/status state machine : established, LruRru Last local dataplane status rcvd: No fault Last BFD dataplane status rcvd: Not sent Last BFD peer monitor status rcvd: No fault Last local AC circuit status rcvd: No fault Last local AC circuit status sent: No fault Last local PW i/f circ status rcvd: No fault Last local LDP TLV status sent: No fault Last remote LDP TLV status rcvd: No fault Last remote LDP ADJ status rcvd: No fault MPLS VC labels: local 17, remote 17 Group ID: local 0, remote 0 MTU: local 1500, remote 1500 Remote interface description: Sequencing: receive disabled, send disabled Control Word: On (configured: autosense) SSO Descriptor: 10.1.1.2/100, local label: 17 Dataplane: SSM segment/switch IDs: 4098/4097 (used), PWID: 1 VC statistics: transit packet totals: receive 0, send 0 transit byte totals: receive 0, send 0 transit packet drops: receive 0, seq error 0, send 0 </pre>

Example

Additional References

Related Documents

Related Topic	Document Title
Cisco IOS commands	Master Commands List, All Releases
Tunnel commands: complete command syntax, command mode, defaults, command history, usage guidelines, and examples	Interface and Hardware Component Command Reference
IPv6 commands: complete command syntax, command mode, defaults, command history, usage guidelines, and examples	IPv6 Command Reference

Technical Assistance

Description	Link
The Cisco Support and Documentation website provides online resources to download documentation, software, and tools. Use these resources to install and configure the software and to troubleshoot and resolve technical issues with Cisco products and technologies. Access to most tools on the Cisco Support and Documentation website requires a Cisco.com user ID and password.	http://www.cisco.com/cisco/web/support/index.html

Feature Information for GRE IPv6 Tunnels

The following table provides release information about the feature or features described in this module. This table lists only the software release that introduced support for a given feature in a given software release train. Unless noted otherwise, subsequent releases of that software release train also support that feature.

Use Cisco Feature Navigator to find information about platform support and Cisco software image support. To access Cisco Feature Navigator, go to www.cisco.com/go/cfn. An account on Cisco.com is not required.

Table 20: Feature Information for GRE IPv6 Tunnels

Feature Name	Releases	Feature Information
GRE IPv6 Tunnels	Cisco IOS XE Release 3.7S	The GRE IPv6 Tunnels feature enables the delivery of packets from other protocols through an IPv6 network and allows the routing of IPv6 packets between private networks across public networks with globally routed IPv6 addresses.
EoMPLS over IPv6 GRE Tunnel	Cisco IOS XE Release 3.15S	The EoMPLS over IPv6 GRE Tunnel feature supports tunneling of EoMPLS traffic via an IPv6 network by using GRE tunnels.



CHAPTER 18

ISATAP Tunnel Support for IPv6

ISATAP is an automatic overlay tunneling mechanism that uses the underlying IPv4 network as a NBMA link layer for IPv6

- [Finding Feature Information, on page 167](#)
- [Information About ISATAP Tunnel Support for IPv6, on page 167](#)
- [How to Configure ISATAP Tunnel Support for IPv6, on page 170](#)
- [Configuration Examples for ISATAP Tunnel Support for IPv6, on page 171](#)
- [Additional References, on page 172](#)
- [Feature Information for ISATAP Tunnel Support for IPv6, on page 172](#)

Finding Feature Information

Your software release may not support all the features documented in this module. For the latest caveats and feature information, see [Bug Search Tool](#) and the release notes for your platform and software release. To find information about the features documented in this module, and to see a list of the releases in which each feature is supported, see the feature information table.

Use Cisco Feature Navigator to find information about platform support and Cisco software image support. To access Cisco Feature Navigator, go to www.cisco.com/go/cfn. An account on Cisco.com is not required.

Information About ISATAP Tunnel Support for IPv6

Overlay Tunnels for IPv6

Overlay tunneling encapsulates IPv6 packets in IPv4 packets for delivery across an IPv4 infrastructure (a core network or the figure below). By using overlay tunnels, you can communicate with isolated IPv6 networks without upgrading the IPv4 infrastructure between them. Overlay tunnels can be configured between border devices or between a border device and a host; however, both tunnel endpoints must support both the IPv4 and IPv6 protocol stacks. IPv6 supports the following types of overlay tunneling mechanisms:

- Manual
- Generic routing encapsulation (GRE)
- IPv4-compatible

- 6to4
- Intrasite Automatic Tunnel Addressing Protocol (ISATAP)

Figure 9: Overlay Tunnels

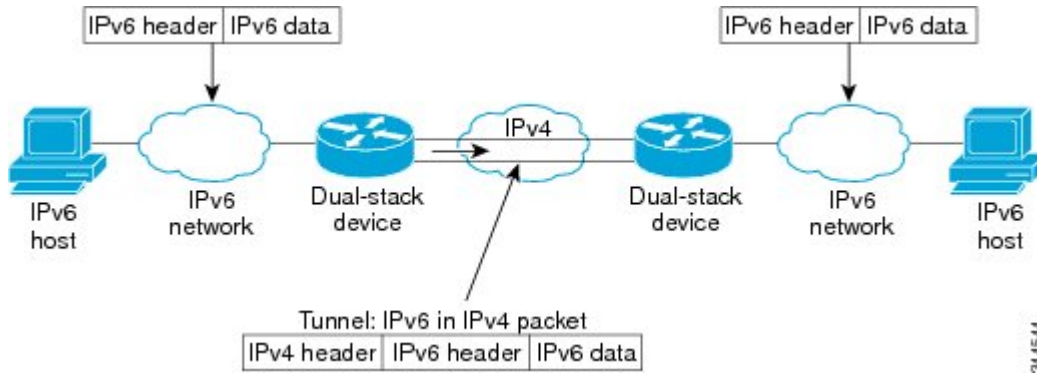

Note Overlay tunnels reduce the maximum transmission unit (MTU) of an interface by 20 octets (assuming that the basic IPv4 packet header does not contain optional fields). A network that uses overlay tunnels is difficult to troubleshoot. Therefore, overlay tunnels that connect isolated IPv6 networks should not be considered a final IPv6 network architecture. The use of overlay tunnels should be considered as a transition technique toward a network that supports both the IPv4 and IPv6 protocol stacks or just the IPv6 protocol stack.

Use the table below to help you determine which type of tunnel that you want to configure to carry IPv6 packets over an IPv4 network.

Table 21: Suggested Usage of Tunnel Types to Carry IPv6 Packets over an IPv4 Network

Tunneling Type	Suggested Usage	Usage Notes
Manual	Simple point-to-point tunnels that can be used within a site or between sites.	Can carry IPv6 packets only.
GRE- and IPv4-compatible	Simple point-to-point tunnels that can be used within a site or between sites.	Can carry IPv6, Connectionless Network Service (CLNS), and many other types of packets.
IPv4-compatible	Point-to-multipoint tunnels.	Uses the <code>::/96</code> prefix. We do not recommend using this tunnel type.
6to4	Point-to-multipoint tunnels that can be used to connect isolated IPv6 sites.	Sites use addresses from the <code>2002::/16</code> prefix.
6RD	IPv6 service is provided to customers over an IPv4 network by using encapsulation of IPv6 in IPv4.	Prefixes can be from the SP's own address block.
ISATAP	Point-to-multipoint tunnels that can be used to connect systems within a site.	Sites can use any IPv6 unicast addresses.

Individual tunnel types are discussed in detail in this document. We recommend that you review and understand the information about the specific tunnel type that you want to implement. When you are familiar with the type of tunnel you need, see the table below for a summary of the tunnel configuration parameters that you may find useful.

Table 22: Tunnel Configuration Parameters by Tunneling Type

Tunneling Type	Tunnel Configuration Parameter			
Tunnel Mode	Tunnel Source	Tunnel Destination	Interface Prefix or Address	
Manual	ipv6ip	An IPv4 address, or a reference to an interface on which IPv4 is configured.	An IPv4 address.	An IPv6 address.
GRE/IPv4	gre ip		An IPv4 address.	An IPv6 address.
IPv4-compatible	ipv6ip auto-tunnel		Not required. These are all point-to-multipoint tunneling types. The IPv4 destination address is calculated, on a per-packet basis, from the IPv6 destination.	Not required. The interface address is generated as <code>::tunnel-source/96</code> .
6to4	ipv6ip 6to4		An IPv6 address. The prefix must embed the tunnel source IPv4 address.	
6RD	ipv6ip 6rd		An IPv6 address.	
ISATAP	ipv6ip isatap		An IPv6 prefix in modified eui-64 format. The IPv6 address is generated from the prefix and the tunnel source IPv4 address.	

ISATAP Tunnels

ISATAP is an automatic overlay tunneling mechanism that uses the underlying IPv4 network as a NBMA link layer for IPv6. ISATAP is designed for transporting IPv6 packets *within* a site where a native IPv6 infrastructure is not yet available; for example, when sparse IPv6 hosts are deployed for testing. ISATAP tunnels allow individual IPv4 or IPv6 dual-stack hosts within a site to communicate with other such hosts on the same virtual link, basically creating an IPv6 network using the IPv4 infrastructure.

The ISATAP router provides standard router advertisement network configuration support for the ISATAP site. This feature allows clients to automatically configure themselves as they would do if they were connected to a GigabitEthernet or FastEthernet. It can also be configured to provide connectivity out of the site. ISATAP uses a well-defined IPv6 address format composed of any unicast IPv6 prefix (/64), which can be link local, or global (including 6to4 prefixes), enabling IPv6 routing locally or on the Internet. The IPv4 address is encoded in the last 32 bits of the IPv6 address, enabling automatic IPv6-in-IPv4 tunneling.

Although the ISATAP tunneling mechanism is similar to other automatic tunneling mechanisms, such as IPv6 6to4 tunneling, ISATAP is designed for transporting IPv6 packets *within* a site, not *between* sites.

ISATAP uses unicast addresses that include a 64-bit IPv6 prefix and a 64-bit interface identifier. The interface identifier is created in modified EUI-64 format in which the first 32 bits contain the value 000:5EFE to indicate that the address is an IPv6 ISATAP address. The table below describes an ISATAP address format.

Table 23: IPv6 ISATAP Address Format

64 Bits	32 Bits	32 Bits
link local or global IPv6 unicast prefix	0000:5EFE	IPv4 address of the ISATAP link

As shown in the table above, an ISATAP address consists of an IPv6 prefix and the ISATAP interface identifier. This interface identifier includes the IPv4 address of the underlying IPv4 link. The following example shows what an actual ISATAP address would look like if the prefix is 2001:DB8:1234:5678::/64 and the embedded IPv4 address is 10.173.129.8. In the ISATAP address, the IPv4 address is expressed in hexadecimal as 0AAD:8108:

2001:DB8:1234:5678:0000:5EFE:0AAD:8108

How to Configure ISATAP Tunnel Support for IPv6

Configuring ISATAP Tunnels

Before you begin

The **tunnel source** command used in the configuration of an ISATAP tunnel must point to an interface with an IPv4 address configured. The ISATAP IPv6 address and prefix (or prefixes) advertised are configured as for a native IPv6 interface. The IPv6 tunnel interface must be configured with a modified EUI-64 address because the last 32 bits in the interface identifier are constructed using the IPv4 tunnel source address.

SUMMARY STEPS

1. **enable**
2. **configure terminal**
3. **interface tunnel *tunnel-number***
4. **ipv6 address {*ipv6-address* / *prefix-length* | *prefix-name* *sub-bits/prefix-length*}**
5. **no ipv6 nd ra suppress**
6. **tunnel source {*ip-address* | *interface-type interface-number*}**
7. **tunnel mode ipv6ip [6rd | 6to4 | auto-tunnel | isatap]**

DETAILED STEPS

	Command or Action	Purpose
Step 1	enable Example: Router> enable	Enables privileged EXEC mode. <ul style="list-style-type: none"> • Enter your password if prompted.
Step 2	configure terminal Example: Router# configure terminal	Enters global configuration mode.

	Command or Action	Purpose
Step 3	interface tunnel <i>tunnel-number</i> Example: <pre>Router(config)# interface tunnel 1</pre>	Specifies a tunnel interface and number, and enters interface configuration mode.
Step 4	ipv6 address { <i>ipv6-address / prefix-length</i> <i>prefix-name sub-bits/prefix-length</i> } Example: <pre>Router(config-if)# ipv6 address 2001:DB8:6301::/64 eui-64</pre>	Specifies the IPv6 address assigned to the interface and enables IPv6 processing on the interface.
Step 5	no ipv6 nd ra suppress Example: <pre>Router(config-if)# no ipv6 nd ra suppress</pre>	Sending of IPv6 router advertisements is disabled by default on tunnel interfaces. This command reenables the sending of IPv6 router advertisements to allow client autoconfiguration.
Step 6	tunnel source { <i>ip-address</i> <i>interface-type interface-number</i> } Example: <pre>Router(config-if)# tunnel source gigabitethernet 1/0/1</pre>	Specifies the source interface type and number for the tunnel interface. Note The interface type and number specified in the tunnel source command must be configured with an IPv4 address.
Step 7	tunnel mode ipv6ip [<i>6rd</i> <i>6to4</i> auto-tunnel isatap] Example: <pre>Router(config-if)# tunnel mode ipv6ip isatap</pre>	Specifies an IPv6 overlay tunnel using a ISATAP address. <ul style="list-style-type: none"> The auto-tunnel keyword is not supported on Cisco ASR 1000 series routers.

Configuration Examples for ISATAP Tunnel Support for IPv6

Example: Configuring ISATAP Tunnels

The following example shows the tunnel source defined on GigabitEthernet 0/0/0 and the **tunnel mode** command used to configure the ISATAP tunnel. Router advertisements are enabled to allow client autoconfiguration.

```
ipv6 unicast-routing
interface tunnel 1
 tunnel source Gigabitethernet 0/0/0
 tunnel mode ipv6ip isatap
 ipv6 address 2001:DB8::/64 eui-64
 no ipv6 nd ra suppress
 exit
```

Additional References

Related Documents

Related Topic	Document Title
IPv6 addressing and connectivity	<i>Cisco IOS IPv6 Configuration Guide</i>
Cisco IOS commands	Cisco IOS Master Commands List, All Releases
IPv6 commands	Cisco IOS IPv6 Command Reference
Cisco IOS IPv6 features	Cisco IOS IPv6 Feature Mapping

Standard/RFC	Title
RFCs for IPv6	<i>IPv6 RFCs</i>

Standards and RFCs

Technical Assistance

Description	Link
The Cisco Support and Documentation website provides online resources to download documentation, software, and tools. Use these resources to install and configure the software and to troubleshoot and resolve technical issues with Cisco products and technologies. Access to most tools on the Cisco Support and Documentation website requires a Cisco.com user ID and password.	http://www.cisco.com/cisco/web/support/index.html

Feature Information for ISATAP Tunnel Support for IPv6

The following table provides release information about the feature or features described in this module. This table lists only the software release that introduced support for a given feature in a given software release train. Unless noted otherwise, subsequent releases of that software release train also support that feature.

Use Cisco Feature Navigator to find information about platform support and Cisco software image support. To access Cisco Feature Navigator, go to www.cisco.com/go/cfn. An account on Cisco.com is not required.

Table 24: Feature Information for ISATAP Tunnel Support for IPv6

Feature Name	Releases	Feature Information
ISATAP Tunnel Support for IPv6	Cisco IOS XE Release 2.1	<p>ISATAP is an automatic overlay tunneling mechanism that uses the underlying IPv4 network as a NBMA link layer for IPv6.</p> <p>The following commands were introduced or modified: ipv6 nd ra suppress, tunnel mode ipv6ip, tunnel source.</p>



CHAPTER 19

VRF-Aware Tunnels

Virtual Routing and Forwarding (VRF)-aware tunnels are used to connect customer networks separated by untrusted core networks or core networks with different infrastructures (IPv4 or IPv6).

- [Finding Feature Information](#), on page 175
- [Prerequisites for VRF-Aware Tunnels](#), on page 175
- [Information About VRF-Aware Tunnels](#), on page 176
- [How to Configure VRF-Aware IPv6 Tunnels](#), on page 177
- [Configuration Examples for VRF-Aware Tunnels](#), on page 185
- [Additional References](#), on page 193
- [Feature Information for VRF-Aware Tunnels](#), on page 194

Finding Feature Information

Your software release may not support all the features documented in this module. For the latest caveats and feature information, see [Bug Search Tool](#) and the release notes for your platform and software release. To find information about the features documented in this module, and to see a list of the releases in which each feature is supported, see the feature information table.

Use Cisco Feature Navigator to find information about platform support and Cisco software image support. To access Cisco Feature Navigator, go to www.cisco.com/go/cfn. An account on Cisco.com is not required.

Prerequisites for VRF-Aware Tunnels

- You must configure customer edge networks. See the [Configuring Customer Edge Networks for Tunneling](#) section.
- You must configure the customer and transport VRFs. See the [Defining a VRF Instance](#) section.

Information About VRF-Aware Tunnels

Tunnel IP Source and Destination VRF Membership

You can configure the source and destination of a tunnel to belong to any VPN routing and forwarding (VRFs) tables. A VRF table stores routing data for each VPN. The VRF table defines the VPN membership of a customer site that is attached to the network access server (NAS). Each VRF table comprises an IP routing table, a derived Cisco Express Forwarding table, and guidelines and routing protocol parameters that control the information that is included in the routing table.

You can configure the tunnel source and destination to belong to any VRF or to a global table. The tunnel becomes disabled if no route to the tunnel destination is defined.

VRF-Aware Tunnels

Virtual Routing and Forwarding (VRF)-aware tunnels are used to connect customer networks that are separated by untrusted IPv4 or IPv6 core networks.

Figure 10: VRF-Aware Tunnels

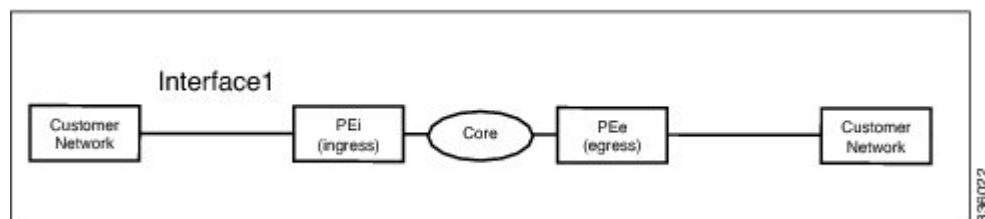

In the above topology, a tunnel is configured in the core network. Provider edge (PE) device PEi, is the tunnel head for packets entering on Interface 1. PE device PEe, is the tunnel tail for packets entering on Interface 1.

The VRF configured on Interface 1 is the customer VRF. Packets entering through Interface 1 are routed using this VRF. Packets exiting the tunnel are forwarded to this VRF. The routing by the customer VRF is called inner IP packet routing.

The VRF configured on the tunnel using the **tunnel vrf** command is the transport VRF. The transport VRF is the VRF that applies to the encapsulated payload and is used to look up the tunnel endpoints. This VRF is the same as the VRF associated with the physical interface over which the tunnel sends packets. The routing by the transport VRF is the outer IP packet routing.

The tunnel endpoint can be configured as an address from the global routing table or an address from a configured transport VRF table.

VRF-Aware IPv6 over IPv6 Tunnels

You can forward IPv6 packets on an untrusted IPv6 infrastructure by creating Virtual Routing and Forwarding (VRF)-aware IPv6 tunnels in it. These tunnels can have endpoints in a VRF table or in a global routing table. The tunnel modes used are **tunnel mode gre ipv6** and **tunnel mode ipv6**.

VRF-Aware IPv4 over IPv6 Tunnels

You can forward IPv4 packets on an untrusted IPv6 infrastructure by creating Virtual Routing and Forwarding (VRF)-aware IPv4 tunnels in it. These tunnels can have endpoints in a VRF table or in a global routing table. The tunnel modes used are **tunnel mode gre ipv6** and **tunnel mode ipv6**.

VRF-Aware IPv6 over IPv4 Tunnels

You can forward IPv6 packets on an untrusted IPv4 infrastructure by creating Virtual Routing and Forwarding (VRF)-aware IPv6 tunnels in it. These tunnels can have endpoints in a VRF table or in a global routing table. The tunnel modes used are **tunnel mode gre ipv4** (default mode) and **tunnel mode ipv4**.

How to Configure VRF-Aware IPv6 Tunnels

To configure a VRF-aware tunnel, you need to perform the following steps:

1. **Define the customer and transport VRF**—Define a customer VRF if the tunnel is VRF-aware. Define a transport VRF if the tunnel endpoint needs to be in a VRF. See the [Defining a VRF Instance](#) section.
2. **Set up the network**—Configure relevant interfaces and configure relevant routes. Ensure that a valid route exists between the PE devices and the PE device and the customer network.
3. **Configure the tunnel between the PE devices**—See the [Configuring a VRF-Aware Tunnel](#) section.
 1. **Configure the tunnel address**
 2. **Configure the tunnel source**—This is an interface on the PE device.
 3. **Configure the tunnel destination**—This is tunnel source of the other PE device. For proper configuration of the tunnel, ensure that the tunnel destination is reachable from the PE device with a ping command (A valid route must exist to the tunnel destination).
 4. **Configure the tunnel mode**
4. **Configure customer edge network**. See the [Configuring Customer Edge Networks for Tunneling](#) section.
5. **Configure static routes using the tunnel**—Configure routes on the PE devices to remote CE networks using the configured tunnel.

Configuring a VRF-Aware Tunnel

This task configures a tunnel between PE1 and PE2, as shown in the image below. The configuration task need to be repeated on both PE devices, PE1 and PE2.

Figure 11: Configuring a VRF-Aware Tunnel

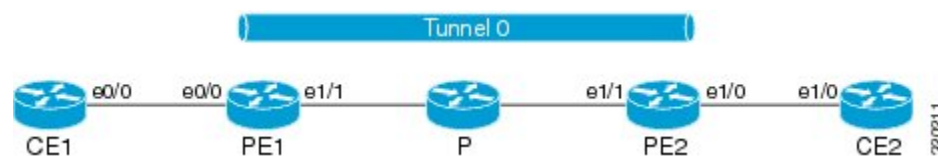

SUMMARY STEPS

1. `interface type number`

2. **vrf forwarding** *transport-vrf-name*
3. • **ip address** *ip-address mask* or
 • **ipv6 address** *ipv6-address/prefix-length*
4. **exit**
5. Configure static routes between provider edge devices.
6. **interface tunnel** *number*
7. **vrf forwarding** *customer-vrf-name*
8. • **ip address** *ip-address mask* or
 • **ipv6 address** *ipv6-address/prefix-length*
9. **tunnel source** *interface-type interface-number*
10. **tunnel destination** [*ip-address* | *ipv6-address*]
11. **tunnel vrf** *transport-vrf-name*
12. **tunnel mode** {*aurp* | *cayman* | *dvmrp* | *eon* | *gre* | *gre multipoint* | *gre ipv6* | *ipip* [*decapsulate-any*] | *ipsec ipv4* | *iptalk* | *ipv6* | *ipsec ipv6* | *mpls* | *nos* | *rbsep*}
13. **exit**
14. • **ip route** [*vrf vrf-name*] *prefix mask interface-type interface-number* [*next-hop-ip-address*]
 or
 • **ipv6 route** [*vrf vrf-name*] *destination-ipv6-prefix interface-type interface-number* [*next-hop-ipv6-address*]
15. **end**

DETAILED STEPS

	Command or Action	Purpose
Step 1	interface <i>type number</i> Example: Device(config)# interface ethernet 1/1	Configures the interface used as a tunnel source.
Step 2	Required: vrf forwarding <i>transport-vrf-name</i> Example: Device(config-if)# vrf forwarding red	(Optional) Associates the transport VRF with the tunnel. Note This step is not required if the tunnel endpoints are in the global routing table.
Step 3	• ip address <i>ip-address mask</i> or • ipv6 address <i>ipv6-address/prefix-length</i> Example: Device(config-if)# ip address 10.22.22.22 255.255.255.255 or Device(config-if)# ipv6 address 2001:DB8:3::1/64	Sets an IP address for the tunnel source interface. • The address configured in this step for PE1 is used as the tunnel endpoint or tunnel destination while configuring the tunnel on PE2 and vice versa. • This address may be in the global routing table or in the VRF.
Step 4	exit Example: Device(config-if)# exit	Exits interface configuration mode and returns to global configuration mode.

	Command or Action	Purpose
Step 5	Configure static routes between provider edge devices.	Provider edge devices are reachable with a ping or ping vrf command.
Step 6	interface tunnel <i>number</i> Example: Device(config)# interface tunnel 0	Configures the tunnel interface and enters interface configuration mode. The same tunnel needs to be configured on PE2.
Step 7	vrf forwarding <i>customer-vrf-name</i> Example: Device(config-if)# vrf forwarding green	(Optional) Associates the customer VRF instance with the tunnel. <ul style="list-style-type: none"> • Packets exiting the tunnel are forwarded to this VRF (inner IP packet routing). Note This step is required only for VRF-aware tunnels.
Step 8	<ul style="list-style-type: none"> • ip address <i>ip-address mask</i> or • ipv6 address <i>ipv6-address/prefix-length</i> Example: Device(config-if)# ip address 10.4.1.1 255.255.255.0 or Device(config-if)# ipv6 address 2001:DB8:3::1/64	Configures an IPv4 or IPv6 address for the tunnel. <ul style="list-style-type: none"> • This address is used as the next-hop address while configuring static routes. Ensure that PE1 and PE2 have addresses within the same network.
Step 9	tunnel source <i>interface-type interface-number</i> Example: Device(config-if)# tunnel source ethernet 1/1	Sets the source address for a tunnel interface.
Step 10	tunnel destination [<i>ip-address ipv6-address</i>] Example: Device(config-if)# tunnel destination 10.44.44.44	(Optional) Specifies the destination for a tunnel interface. <ul style="list-style-type: none"> • The tunnel source address of device PE2 is used as the tunnel destination address of PE1 and vice versa. • If an IPv6 infrastructure exists between the two PE devices, use an IPv6 address. If an IPv4 infrastructure exists between the two PE devices, use an IPv4 address (IPv6 over IPv4 tunnel).
Step 11	tunnel vrf <i>transport-vrf-name</i> Example: Device(config-if)# tunnel vrf red	(Optional) Associates the transport VRF with the tunnel. <ul style="list-style-type: none"> • This VRF is the same as the VRF associated with the physical interface over which the tunnel sends packets (outer IP packet routing). Note This step is not required if the tunnel endpoints are in the global routing table.

	Command or Action	Purpose
Step 12	tunnel mode {aurp cayman dvmrp eon gre gre multipoint gre ipv6 ipip [decapsulate-any] ipsec ipv4 iptalk ipv6 ipsec ipv6 mpls nos rbscp} Example: Device(config-if)# tunnel mode ipv6	(Optional) Sets the encapsulation mode for the tunnel interface. Note This step is not required if the tunnel mode is GRE IPv4 as this is the default mode.
Step 13	exit Example: Device(config-if)# exit	Exits interface configuration mode and enters global configuration mode.
Step 14	<ul style="list-style-type: none"> • ip route [vrf vrf-name] prefix mask interface-type interface-number [next-hop-ip-address] or • ipv6 route [vrf vrf-name] destination-ipv6-prefix interface-type interface-number [next-hop-ipv6-address] Example: Device(config)# ip route 10.44.44.0 255.255.255.0 10.22.22.23 Device(config)# ip route vrf red 10.44.44.0 255.255.255.0 10.22.22.23 or Device(config)# ipv6 route 2001:DB8:2:2::/64 2001:DB8:2:1::2 Device(config)# ipv6 route vrf green 2001:DB8:2:2::/64 2001:DB8:2:1::2	Establishes static routes to remote customer networks by using the configured tunnel. <ul style="list-style-type: none"> • Use the tunnel address as the next hop. • For PE1, configure a static route to network PE2-CE2. For PE2, configure a static route to network PE1-CE1.
Step 15	end Example: Device(config)# end	Exits global configuration mode and returns to privileged EXEC mode.

What to do next

Verify the IPv6 Tunnels. See [Verifying VRF-Aware Tunnels](#)

Defining a VRF Instance

Perform this task to make a device Virtual Routing and Forwarding (VRF)-aware and to configure VRF-aware tunnels.

SUMMARY STEPS

1. **vrf definition** vrf-name
2. **rd** route-distinguisher
3. **route-target export** route-target-ext-community
4. **route-target import** route-target-ext-community
5. **address-family** {ipv4 | ipv6}
6. **exit-address-family**

7. exit

DETAILED STEPS

	Command or Action	Purpose
Step 1	vrf definition <i>vrf-name</i> Example: Device(config)# vrf definition green	Enters IP VRF configuration mode for defining a VRF routing table instance.
Step 2	rd <i>route-distinguisher</i> Example: Device(config-vrf)# rd 1:1	Specifies a route distinguisher (RD) for a VRF instance.
Step 3	route-target export <i>route-target-ext-community</i> Example: Device(config-vrf)# route-target export 1:1	Exports routing information to the target VPN extended community.
Step 4	route-target import <i>route-target-ext-community</i> Example: Device(config-vrf)# route-target import 1:1	Imports routing information to the target VPN extended community.
Step 5	address-family {ipv4 ipv6} Example: Device(config-vrf)# address-family ipv6	Enters VRF address-family configuration mode to configure a routing session using standard IPv4 or IPv6 address prefixes.
Step 6	exit-address-family Example: Device(config-vrf-af)# exit-address-family	Exits VRF address-family configuration mode and enters IP VRF configuration mode.
Step 7	exit Example: Device(config-vrf)# exit	Exits IP VRF configuration mode and enters global configuration mode.

Configuring Customer Edge Networks for Tunneling

Perform this task to configure a customer edge (CE) network. In this configuration, the CE network is a network with CE devices connected to a provider edge (PE) device. PE1 and CE1 are connected and PE2 and CE2 are connected. Addresses must be configured accordingly.

Before you begin

To define a customer VRF, see the [Defining a VRF Instance](#) section.

SUMMARY STEPS

1. **interface** *type number*
2. **vrf forwarding** *customer-vrf-name*

3. • **ip address** *ip-address mask* or
• **ipv6 address** *ipv6-address/prefix-length*
4. **exit**

DETAILED STEPS

	Command or Action	Purpose
Step 1	interface <i>type number</i> Example: Device(config)# interface Ethernet 0/0	Configures an interface type and enters interface configuration mode.
Step 2	vrf forwarding <i>customer-vrf-name</i> Example: Device(config-if)# vrf forwarding green	(Optional) Associates a VRF instance or a virtual network with the tunnel. Note This step is required only if the interface needs to be associated with a VRF.
Step 3	• ip address <i>ip-address mask</i> or • ipv6 address <i>ipv6-address/prefix-length</i> Example: Device(config-if)# ip address 10.22.22.22 255.255.255.0 or Device(config-if)# ipv6 address 2001:DB8:1::1/64	Configures an address for the interface. • Ensure that CE devices connected to the PE device are on the same network.
Step 4	exit Example: Device(config-if)# exit	Exits interface configuration mode and enters global configuration mode.

Verifying VRF-Aware Tunnels

Use the following commands to verify Virtual Routing and Forwarding (VRF)-aware tunnels:

SUMMARY STEPS

1. **show tunnel interface**
2. **show ip route** *ip-address*
3. **show ip route vrf** *vrf-name ip-address*
4. **ping ipv6** *ipv6-address source ipv6-address*
5. **ping vrf** *vrf-name ipv6-address source ipv6-address*
6. **debug ipv6 icmp**

DETAILED STEPS

Step 1 **show tunnel interface**

This command displays detailed information about all tunnel interfaces.

Example:

The following is sample output from a provider edge (PE) device with Generic Routing Encapsulation (GRE) tunnel mode:

```
Device# show tunnel interface

Tunnel0
  Mode:GRE/IP, Destination 10.44.44.44, Source Loopback2
  IP transport: output interface Ethernet1/0 next hop 10.0.0.2,
  Tunnel header destination 10.44.44.44
  Application ID 1: unspecified
  Linestate - current up, cached up
  Internal linestate - current up, evaluated up
```

Example:

The following is sample output from a PE device with IPv6/IP tunnel mode:

```
Device# show tunnel interface

Tunnel0
  Mode:IPv6/IP, Destination 44.44.44.44, Source Loopback2
  IP transport: output interface Ethernet1/0 next hop 2.0.0.2,
  Tunnel header destination 44.44.44.44
  Application ID 1: unspecified
  Linestate - current up, cached up
  Internal linestate - current up, evaluated up
```

The output is displayed and the tunnel mode is observed.

Step 2 `show ip route ip-address`

This command displays detailed routing information to a tunnel destination address.

Example:

The following is sample output from a PE device with the tunnel endpoint in the global routing table:

```
Device# show ip route 10.44.44.44

Routing entry for 10.44.44.44/32
Known via "ospf 1", distance 110, metric 21, type intra area
Last update from 10.0.0.2 on Ethernet1/0, 01:10:25 ago
Routing Descriptor Blocks:
* 10.0.0.2, from 10.44.44.44, 01:10:25 ago, via Ethernet1/0
  Route metric is 21, traffic share count is 1
```

The following is sample output from a PE device having tunnel endpoints in the VRF table:

```
Device# show ip route 10.44.44.44

% Network not in table
```

The output is displayed and you can observe if the tunnel destination is in the global routing table or not.

Step 3 `show ip route vrf vrf-name ip-address`

This command displays detailed routing information to a destination IP address.

Example:

The following is sample output from PE1:

```
Device# show ip route vrf green 10.4.4.4

Routing entry for 10.4.4.4/32
  Known via "static", distance 1, metric 0
  Routing Descriptor Blocks:
    * 10.0.0.2, via Ethernet1/0
      Route metric is 0, traffic share count is 1
```

The tunnel destination address 10.4.4.4 is not in the global routing table.

Step 4 **ping ipv6** *ipv6-address source ipv6-address*

This command displays the status of the connectivity between two devices.

Example:

The following is sample output from a customer edge (CE) device CE1 with a **ping** command issued to CE2:

```
Device# ping ipv6 2001:DB8:2::1 source 2001:DB8:1::1

Type escape sequence to abort.
Sending 5, 100-byte ICMP Echos to 2001:DB8:2::1, timeout is 2 seconds:
Packet sent with a source address of 2001:DB8:1::1
!!!!
Success rate is 100 percent (5/5), round-trip min/avg/max = 0/2/4 ms
```

Step 5 **ping vrf** *vrf-name ipv6-address source ipv6-address*

The VRF-ping tests the VPN connection.

Example:

The following is sample output from CE1 with a **ping vrf** command issued to CE2:

```
Device# ping vrf green ipv6 2001:DB8:2::1 source 2001:DB8:1::1

Type escape sequence to abort.
Sending 5, 100-byte ICMP Echos to 2001:DB8:2::1, timeout is 2 seconds:
Packet sent with a source address of 2001:DB8:1::2%green
!!!!
```

If the displayed output indicates success, the VPN is configured correctly.

Step 6 **debug ipv6 icmp**

This command displays debugging messages for IPv6 Internet Control Message Protocol (ICMP) transactions.

Example:

The following is sample output:

```
Device# debug ipv6 icmp

ICMP Packet debugging is on

*Apr 6 14:08:10.743: ICMPv6: Received echo request, Src=2001:DB8:1::2, Dst=2001:DB8:2::1
*Apr 6 14:08:10.743: ICMPv6: Sent echo reply, Src=2001:DB8:2::1, Dst=2001:DB8:1::2
...
```

If the displayed output indicates success, the VPN is configured correctly.

Configuration Examples for VRF-Aware Tunnels

Example: Configuring a VRF-Aware Tunnel (Tunnel Endpoint in Global Routing Table)

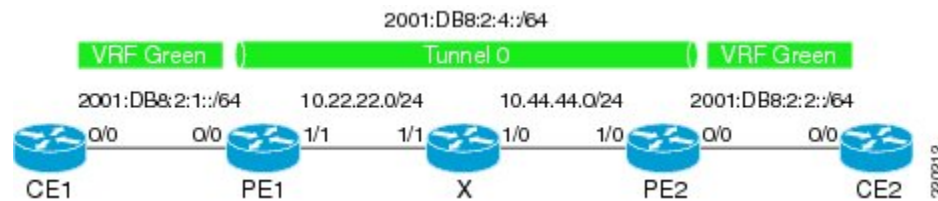

Example: Configuring CE1

```

!
ipv6 unicast-routing
ipv6 cef
!
vrf definition green
rd 1:1
route-target export 1:1
route-target import 1:1
address-family ipv6
exit-address-family
exit
!
interface Ethernet0/0
vrf forwarding green
no ip address
ipv6 address 2001:DB8:2:1::1/64
no shutdown
exit
!
!
ipv6 route vrf green 2001:DB8:2:2::/64 2001:DB8:2:1::2
ipv6 route vrf green 2001:DB8:2:4::/64 2001:DB8:2:1::2
!

```

Example: Configuring PE1

```

ipv6 unicast-routing
ipv6 cef
!
vrf definition green
rd 1:1
route-target export 1:1
route-target import 1:1

```

Example: Configuring a VRF-Aware Tunnel (Tunnel Endpoint in Global Routing Table)

```

address-family ipv6
exit-address-family
exit
!
interface Tunnel0
no ip address
vrf forwarding green
ipv6 address 2001:DB8:2:4::1/64
tunnel source 10.22.22.22
tunnel destination 10.44.44.44
exit
!
interface Ethernet0/0
vrf forwarding green
no ip address
ipv6 address 2001:DB8:2:1::2/64
no shutdown
exit
!
interface Ethernet1/1
no ip address
ip address 10.22.22.22 255.255.255.0
no shutdown
exit
!
ip route 10.44.44.0 255.255.255.0 10.22.22.23
ipv6 route vrf green 2001:DB8:2:2::/64 Tunnel0 2001:DB8:2:4::2

```

Example: Configuring PE2

```

!
ipv6 unicast-routing
ipv6 cef
!
vrf definition green
rd 1:1
route-target export 1:1
route-target import 1:1
address-family ipv6
exit-address-family
exit
!
interface Tunnel0
vrf forwarding green
no ipv6 address
ipv6 address 2001:DB8:2:4::2/64
tunnel source 10.44.44.44
tunnel destination 10.22.22.22
exit
!
interface Ethernet0/0
vrf forwarding green
no ipv6 address
ipv6 address 2001:DB8:2:2::1/64
no shutdown
exit
!
interface Ethernet1/0
no ip address
ip address 10.44.44.44 255.255.255.0

```



```
no shutdown
exit
!
ip route 10.22.22.0 255.255.255.0 10.44.44.43
!
ipv6 route vrf green 2001:DB8:2:1::/64 Tunnel0 2001:DB8:2:4::1
!
```

Example: Configuring CE2

```
!
ipv6 unicast-routing
ipv6 cef
!
vrf definition green
rd 1:1
route-target export 1:1
route-target import 1:1
address-family ipv6
exit-address-family
exit
!
interface Ethernet0/0
vrf forwarding green
no ipv6 address
ipv6 address 2001:DB8:2:2::2/64
no shutdown
exit
!
!
ipv6 route vrf green 2001:DB8:2:1::/64 2001:DB8:2:2::1
ipv6 route vrf green 2001:DB8:2:4::/64 2001:DB8:2:2::1
!
```

Example: Configuring Device X

```
!
interface Ethernet1/0
no ip address
ip address 10.44.44.43 255.255.255.0
no shutdown
exit
!
interface Ethernet1/1
no ip address
ip address 10.22.22.23 255.255.255.0
no shutdown
exit
!
```

Example: Verifying the Tunnel Configuration

From CE1

Example: Configuring a VRF-Aware Tunnel (Tunnel Endpoint in Global Routing Table)

```

Device# ping vrf green ipv6 2001:db8:2:2::2

Type escape sequence to abort.
Sending 5, 100-byte ICMP Echos to 2001:DB8:2:2::2, timeout is 2 seconds:
!!!!
Success rate is 100 percent (5/5), round-trip min/avg/max = 1/2/6 ms

Device# ping vrf green ipv6 2001:db8:2:2::2 source 2001:db8:2:1::1

Type escape sequence to abort.
Sending 5, 100-byte ICMP Echos to 2001:DB8:2:2::2, timeout is 2 seconds:
Packet sent with a source address of 2001:DB8:2:1::1
!!!!
Success rate is 100 percent (5/5), round-trip min/avg/max = 1/1/1 ms

```

From PE1

```

Device# show tunnel interface

Tunnel0
  Mode:GRE/IP, Destination 10.44.44.44, Source 10.22.22.22
  IP transport: output interface Ethernet1/1 next hop 10.22.22.23
  Application ID 1: unspecified
  Linestate - current up
  Internal linestate - current up, evaluated up
  Tunnel Source Flags: Local
  Transport IPv4 Header DF bit cleared
  OCE: IP tunnel decap
  Provider: interface Tu0, prot 47
  Performs protocol check [47]
  Protocol Handler: GRE: opt 0x0
    ptype: ipv4 [ipv4 dispatcher: punt]
    ptype: ipv6 [ipv6 dispatcher: from if Tu0]
    ptype: mpls [mpls dispatcher: drop]
    ptype: otv [mpls dispatcher: drop]
    ptype: generic [mpls dispatcher: drop]
  There are 0 tunnels running over the EON IP protocol
  There are 0 tunnels running over the IPinIP protocol
  There are 0 tunnels running over the NOSIP protocol
  There are 0 tunnels running over the IPv6inIP protocol
  There are 0 tunnels running over the RBSCP/IP protocol

```

```

Device# show ip route 10.44.44.44

```

```

Routing entry for 10.44.44.0/24
  Known via "static", distance 1, metric 0
  Routing Descriptor Blocks:
  * 10.22.22.23
    Route metric is 0, traffic share count is 1

```

```

Device# debug ipv6 icmp

```

```

ICMP Packet debugging is on
*Jan 1 10:57:37.882: ICMPv6: Sent R-Advert, Src=FE80::A8BB:CCFF:FE00:5200, Dst=FF02::1
*Jan 1 11:00:18.634: ICMPv6: Received R-Advert, Src=FE80::A8BB:CCFF:FE00:5200, Dst=FF02::1

```

Example: Configuring a VRF-Aware Tunnel (Tunnel Endpoint in VRF)

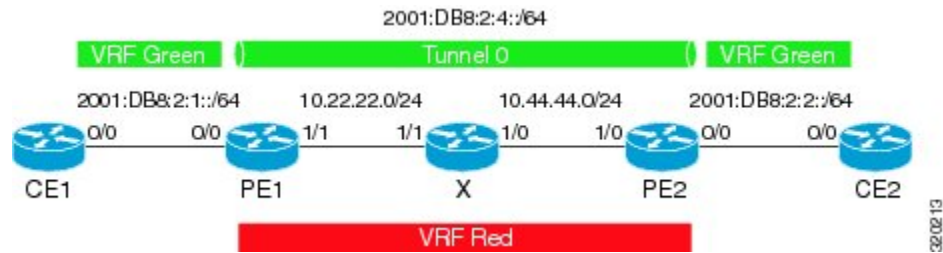

Example: Configuring CE1

```

!
ipv6 unicast-routing
ipv6 cef
!
vrf definition green
rd 1:1
route-target export 1:1
route-target import 1:1
address-family ipv6
exit-address-family
exit
!
interface Ethernet0/0
vrf forwarding green
no ip address
ipv6 address 2001:DB8:2:1::1/64
no shutdown
exit
!
!
ipv6 route vrf green 2001:DB8:2:2::/64 2001:DB8:2:1::2
ipv6 route vrf green 2001:DB8:2:4::/64 2001:DB8:2:1::2
!

```

Example: Configuring PE1

```

ipv6 unicast-routing
ipv6 cef
!
vrf definition green
rd 1:1
route-target export 1:1
route-target import 1:1
address-family ipv6
exit-address-family
exit
!
vrf definition red
rd 2:2
route-target export 2:2
route-target import 2:2
address-family ipv4
exit-address-family
exit

```

Example: Configuring a VRF-Aware Tunnel (Tunnel Endpoint in VRF)

```

!
interface Tunnel0
  no ip address
  vrf forwarding green
  ipv6 address 2001:DB8:2:4::1/64
  tunnel source 10.22.22.22
  tunnel destination 10.44.44.44
  tunnel vrf red
  exit
!
interface Ethernet0/0
  vrf forwarding green
  no ip address
  ipv6 address 2001:DB8:2:1::2/64
  no shutdown
  exit
!
interface Ethernet1/1
  vrf forwarding red
  no ip address
  ip address 10.22.22.22 255.255.255.0
  no shutdown
  exit
!
ip route vrf red 10.44.44.0 255.255.255.0 10.22.22.23
ipv6 route vrf green 2001:DB8:2:2::/64 Tunnel0 2001:DB8:2:4::2

```

Example: Configuring PE2

```

!
ipv6 unicast-routing
ipv6 cef
!
vrf definition green
  rd 1:1
  route-target export 1:1
  route-target import 1:1
  address-family ipv6
  exit-address-family
  exit
!
vrf definition red
  rd 2:2
  route-target export 2:2
  route-target import 2:2
  address-family ipv4
  exit-address-family
  exit
!
interface Tunnel0
  vrf forwarding green
  no ipv6 address
  ipv6 address 2001:DB8:2:4::2/64
  tunnel source 10.44.44.44
  tunnel destination 10.22.22.22
  tunnel vrf red
  exit
!
interface Ethernet0/0
  vrf forwarding green

```

```

no ipv6 address
ipv6 address 2001:DB8:2:2::1/64
no shutdown
exit
!
interface Ethernet1/0
vrf forwarding red
no ip address
ip address 10.44.44.44 255.255.255.0
no shutdown
exit
!
ip route vrf red 10.22.22.0 255.255.255.0 10.44.44.43
!
ipv6 route vrf green 2001:DB8:2:1::/64 Tunnel0 2001:DB8:2:4::1
!

```

Example: Configuring CE2

```

!
ipv6 unicast-routing
ipv6 cef
!
vrf definition green
rd 1:1
route-target export 1:1
route-target import 1:1
address-family ipv6
exit-address-family
exit
!
interface Ethernet0/0
vrf forwarding green
no ipv6 address
ipv6 address 2001:DB8:2:2::2/64
no shutdown
exit
!
!
ipv6 route vrf green 2001:DB8:2:1::/64 2001:DB8:2:2::1
ipv6 route vrf green 2001:DB8:2:4::/64 2001:DB8:2:2::1
!

```

Example: Configuring Device X

```

!
interface Ethernet1/0
vrf forwarding red
no ip address
ip address 10.44.44.43 255.255.255.0
no shutdown
exit
!
interface Ethernet1/1
vrf forwarding red
no ip address
ip address 10.22.22.23 255.255.255.0

```

Example: Configuring a VRF-Aware Tunnel (Tunnel Endpoint in VRF)

```
no shutdown
exit
!
```

Example: Verifying the Tunnel Configuration

From CE1

```
Device# ping vrf green ipv6 2001:db8:2:2::2
```

```
Type escape sequence to abort.
Sending 5, 100-byte ICMP Echos to 2001:DB8:2:2::2, timeout is 2 seconds:
!!!!
Success rate is 100 percent (5/5), round-trip min/avg/max = 1/2/6 ms
```

```
Device# ping vrf green ipv6 2001:db8:2:2::2 source 2001:db8:2:1::1
```

```
Type escape sequence to abort.
Sending 5, 100-byte ICMP Echos to 2001:DB8:2:2::2, timeout is 2 seconds:
Packet sent with a source address of 2001:DB8:2:1::1
!!!!
Success rate is 100 percent (5/5), round-trip min/avg/max = 1/1/1 ms
```

From PE1

```
Device# show tunnel interface
```

```
Tunnel0
  Mode:GRE/IP, Destination 10.44.44.44, Source 10.22.22.22
  IP transport: output interface Ethernet1/1 next hop 10.22.22.23
  Application ID 1: unspecified
  Linestate - current up
  Internal linestate - current up, evaluated up
  Tunnel Source Flags: Local
  Transport IPv4 Header DF bit cleared
  OCE: IP tunnel decap
  Provider: interface Tu0, prot 47
    Performs protocol check [47]
    Protocol Handler: GRE: opt 0x0
      ptype: ipv4 [ipv4 dispatcher: punt]
      ptype: ipv6 [ipv6 dispatcher: from if Tu0]
      ptype: mpls [mpls dispatcher: drop]
      ptype: otv [mpls dispatcher: drop]
      ptype: generic [mpls dispatcher: drop]
  There are 0 tunnels running over the EON IP protocol
  There are 0 tunnels running over the IPinIP protocol
  There are 0 tunnels running over the NOSIP protocol
  There are 0 tunnels running over the IPv6inIP protocol
  There are 0 tunnels running over the RBSCP/IP protocol
```

```
Device# show ip route 10.44.44.44
```

```
% Network not in table
```

```
Device# show ip route vrf red 10.44.44.44
```

```
Routing Table: red
Routing entry for 10.44.44.0/24
  Known via "static", distance 1, metric 0
```

```

Routing Descriptor Blocks:
* 10.22.22.23
  Route metric is 0, traffic share count is 1

Device# debug ipv6 icmp

ICMP Packet debugging is on
*Jan  1 10:57:37.882: ICMPv6: Sent R-Advert, Src=FE80::A8BB:CCFF:FE00:5200, Dst=FF02::1
*Jan  1 11:00:18.634: ICMPv6: Received R-Advert, Src=FE80::A8BB:CCFF:FE00:5200,Dst=FF02::1

```

Additional References

Related Documents

Related Topic	Document Title
IPv6 addressing and connectivity	<i>Cisco IOS IPv6 Configuration Guide</i>
Cisco IOS commands	Cisco IOS Master Commands List, All Releases
IPv6 commands	Cisco IOS IPv6 Command Reference
Cisco IOS IPv6 features	Cisco IOS IPv6 Feature Mapping

Standard/RFC	Title
RFCs for IPv6	<i>IPv6 RFCs</i>

Standards and RFCs

Technical Assistance

Description	Link
The Cisco Support and Documentation website provides online resources to download documentation, software, and tools. Use these resources to install and configure the software and to troubleshoot and resolve technical issues with Cisco products and technologies. Access to most tools on the Cisco Support and Documentation website requires a Cisco.com user ID and password.	http://www.cisco.com/cisco/web/support/index.html

Feature Information for VRF-Aware Tunnels

The following table provides release information about the feature or features described in this module. This table lists only the software release that introduced support for a given feature in a given software release train. Unless noted otherwise, subsequent releases of that software release train also support that feature.

Use Cisco Feature Navigator to find information about platform support and Cisco software image support. To access Cisco Feature Navigator, go to www.cisco.com/go/cfn. An account on Cisco.com is not required.

Table 25: Feature Information for VRF-Aware Tunnels

Feature Name	Releases	Feature Information
VRF-Aware Tunnels	Cisco IOS XE Release 3.8S	Virtual Routing and Forwarding (VRF)-aware tunnels are used to connect customer networks separated by untrusted core networks or core networks with different infrastructures (IPv4 or IPv6). The following command was modified to support IPv6 transport: tunnel vrf .



CHAPTER 20

Ethernet over GRE Tunnels

The Ethernet over GRE Tunnels feature allows customers to leverage existing low-end residential gateways to provide mobility services to mobile nodes using Proxy Mobile IPv6 (PMIPv6), General Packet Radio Service (GPRS) Tunneling Protocol (GTP), and Intelligent Service Gateway (ISG).

- [Finding Feature Information, on page 195](#)
- [Restrictions for Ethernet over GRE Tunnels, on page 195](#)
- [Information About Ethernet over GRE Tunnels, on page 196](#)
- [How to Configure an Ethernet over GRE tunnel, on page 201](#)
- [Configuration Examples for Ethernet over GRE Tunnels, on page 204](#)
- [Additional References, on page 205](#)
- [Feature Information for Ethernet over GRE Tunnels, on page 206](#)

Finding Feature Information

Your software release may not support all the features documented in this module. For the latest caveats and feature information, see [Bug Search Tool](#) and the release notes for your platform and software release. To find information about the features documented in this module, and to see a list of the releases in which each feature is supported, see the feature information table.

Use Cisco Feature Navigator to find information about platform support and Cisco software image support. To access Cisco Feature Navigator, go to www.cisco.com/go/cfn. An account on Cisco.com is not required.

Restrictions for Ethernet over GRE Tunnels

- Mobile nodes can have only IPv4 addresses
- IPv6 mobile clients are not supported
- If the VLAN priority tag inside the EoGRE packet is set to a nonzero value, ISG or iWAG ignores the packet

Information About Ethernet over GRE Tunnels

The Ethernet over GRE tunnels feature allows customers to leverage existing low-end residential gateways to provide mobility services to mobile nodes.

As service provider Wi-Fi space gains popularity, Cisco customers need to provide access to the Internet and mobile services using public hotspots. A high-end RG can provide these mobility services using Proxy Mobile IPv6 (PMIPv6), Intelligent Service Gateway (ISG) or General Packet Radio Service (GPRS) Tunneling Protocol (GTP).

Low-end RGs or customer premises equipment (CPE) can be used to forward traffic from Mobile nodes to high-end devices. These RGs or CPE can be configured in bridged mode, and Ethernet over Generic Routing Encapsulation (GRE) tunnels can be used to forward Ethernet traffic to the aggregation device.

Mobile nodes access the Internet over Wi-Fi access points (APs). The APs are either autonomous or connected to a wireless LAN controller (WLC). These APs and WLCs are generically referred to as RGs or CPEs. The CPEs are located at individual or community residences and may be connected to the service-provider network through a connection mechanism like an asymmetric DSL (ADSL) modem or a cable modem. The connection mechanism is transparent to the aggregation device.

These CPEs are provided, provisioned, and managed by the service provider as a part of the broadband access service. Generally, there is extra bandwidth on the Wi-Fi AP as well as the back-end pipe to the service provider, which can be used to provide mobile-Internet services to roaming customers in the vicinity.

Mobility Services Using PMIPv6

You can use PMIPv6 to provide mobility services to mobile devices, but you would require high-end RGs with Mobile Access Gateways (MAG) functionality.

RGs or CPEs can also be used to forward traffic from Mobile nodes to MAG-enabled aggregation devices using Ethernet over GRE tunnels.

The aggregation device can create IP sessions and allocate IP addresses (locally or in proxy mode) in a manner similar to regular IP sessions on physical Ethernet interfaces.

Figure 12: Mobility Services Using PMIPv6

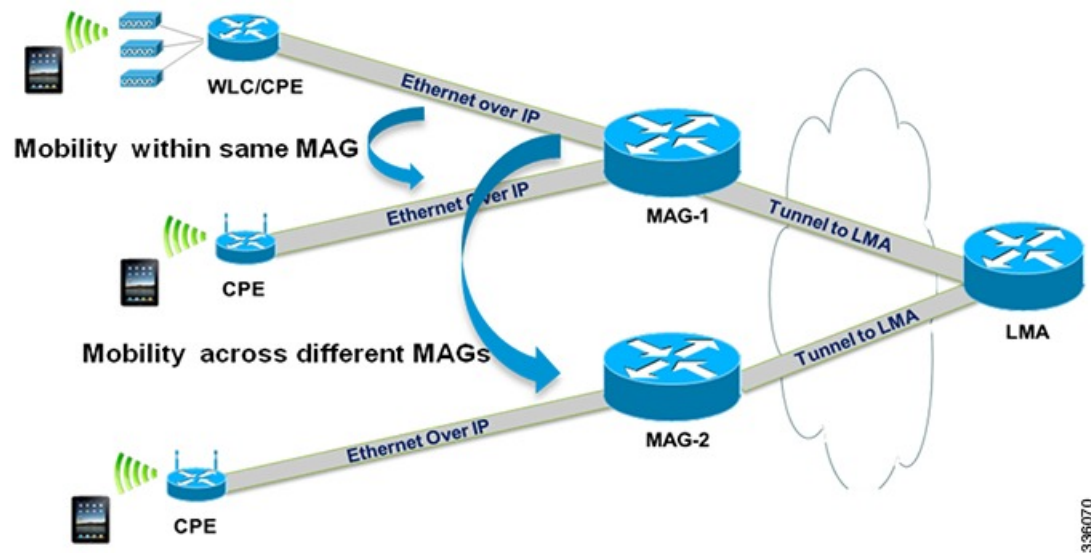

In the deployment scenario given in the above figure, MAG-1 and MAG-2 are configured to handle tunneled Ethernet traffic from access side and also have regular IP tunnels to one or more local mobility anchor (LMA).

Mobility Services Using GTP

You can use GTP to provide mobility services to mobile devices, but you would require high-end RGs with Enhanced Wireless Access Gateway functionality.

RGs or CPEs can also be used to forward traffic from Mobile nodes to Enhanced Wireless Access Gateway devices using Ethernet over GRE tunnels.

Figure 13: Mobility Services Using GTP

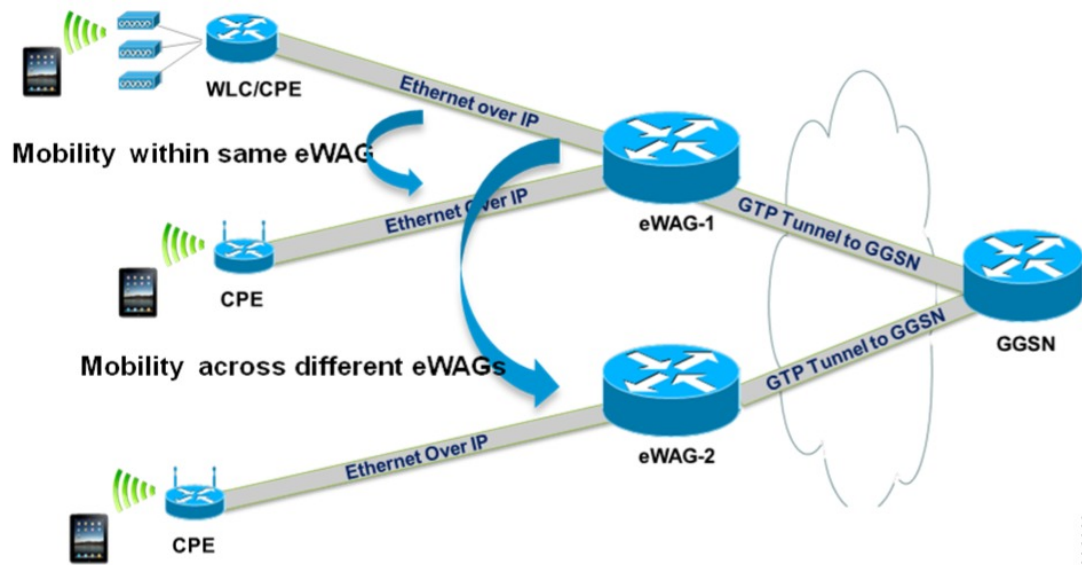

336069

In the deployment scenario given in the above figure, eWAG-1 and eWAG-2 are configured to handle tunneled Ethernet traffic from access side and also have one or more GTP tunnels to one or more gateway Cisco General packet radio service (GPRS) support node (GGSN) devices.

Mobility Services Using ISG

You can use ISG to provide simple IP services to mobile devices but you would require a high-end RGs with ISG functionality.

RGs or CPEs can also be used to forward traffic from Mobile nodes to ISG devices using Ethernet over GRE tunnels as shown in the figure below.

Figure 14: Mobility Services Using ISG

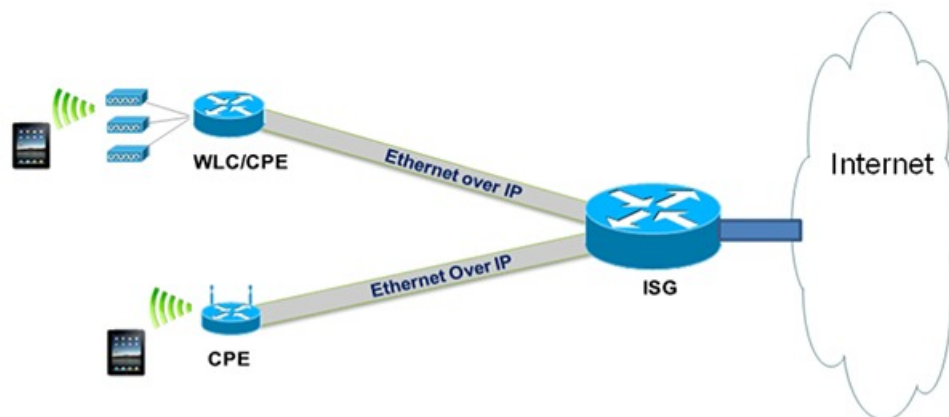

336068

Ethernet over GRE Tunnels Supported Functionality

The Ethernet over GRE tunnels feature supports the following functionality:

- Mobility services can be provided to the mobile nodes using existing low-end residential gateways (RGs) using Ethernet over generic routing and encapsulation (GRE) tunnels. Intelligent Service Gateway (ISG), Proxy Mobile IPv6 (PMIPv6), and GPRS Tunneling Protocol (GTP) can be used to provide the mobility services.
- Ethernet frames can be transported over IPv6 and IPv4 infrastructures. Customer premises Equipment (CPE) is pre-configured with a point-to-point Generic Routing Encapsulation (GRE) IPv4 or IPv6 tunnel. The tunnel destination is a well-known IPv4 or IPv6 address of an aggregation device.
- Tunnels can be configured to be part of a single VLAN—The CPE may insert a VLAN tag in the Ethernet frame. Only a single VLAN tag is supported.
- Tunnels can be configured with a statically configured, symmetric GRE key. You can use the **tunnel key** command to configure this key.
- Sessions can be created with DHCP for IPv4 (DHCPv4), unclassified MAC, and Address Resolution Protocol (ARP) Detecting Network Attachments for IPv4 (DNAv4).

Tunnel Encapsulation in Ethernet over GRE tunnels

Tunnel encapsulation in Ethernet over GRE tunnels is similar to tunnel encapsulation in multipoint Generic Routing Encapsulation (mGRE) tunnels, given in the below figure.

Figure 15: Comparison of Ethernet over GRE tunnels and mGRE tunnels

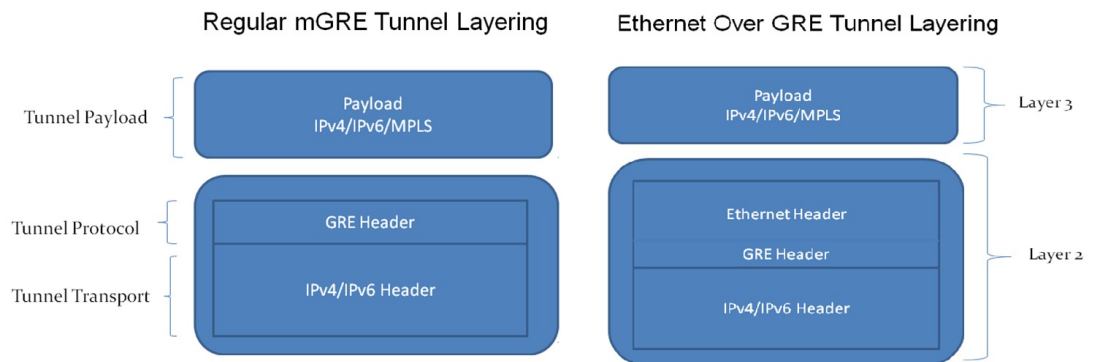

The mGRE tunnel is a nonbroadcast multiAccess (NBMA) interface that can handle multiple tunnel endpoints. The mGRE tunnel can forward payloads like IPv4, IPv6, and Multiprotocol Label Switching (MPLS) in GRE-encapsulated IPv4/IPv6 transport frames from different endpoints, which can then be sent to specific endpoints. While transmitting, the mGRE tunnel interface encapsulates the payload with GRE and transports IPv4/IPv6 headers. On the receiving end, the mGRE tunnel interface strips the GRE and transport header and forwards the payload.

In Ethernet over GRE tunnels, the Ethernet header is included in the tunnel encapsulation along with GRE and transport header.

The tunnel modes used for Ethernet over GRE IPv4 transport can be set using the **tunnel mode ethernet gre ipv4** command.

Similarly, the tunnel modes used for Ethernet over GRE IPv6 transport can be set using the **tunnel mode ethernet gre ipv6** command.

You can see the source of the tunnel by using the **show tunnel source tracking** command.

Although the Ethernet over GRE tunnel simulates regular Ethernet behavior for all practical purposes, the interface is an NBMA interface at the data-link layer. As there may be many mobile nodes and CPE connected to the Ethernet over GRE tunnel, broadcasting a packet is not supported. Even if an aggregation device like the Mobile Access Gateway (MAG) needs to use a broadcast MAC address in the downstream packet frame, the message is unicast to only the respective CPE. Similarly, multicast messages are also sent as unicast messages to the mobile nodes.

Virtual MAC Address

An Ethernet over GRE tunnel is configured with a virtual MAC address. When a packet enters the tunnel, the tunnel accepts the packet only if the destination MAC address of the packet matches the virtual MAC address of the tunnel or the broadcast MAC address. Otherwise, the packet is dropped.



Note If the tunnel interface is configured to handle multicast traffic for specific multicast groups, the corresponding MAC addresses are also accepted by the tunnel.

If PMIPv6 or GTP is enabled on the tunnel, the protocols provide a virtual MAC address that is used as the source MAC address of packets exiting the tunnel. If PMIPv6 or GTP is not enabled, the virtual MAC address of the tunnel interface is used as the source MAC address of the exiting packets.

Virtual MAC addresses are associated with the tunnel using the **mac-address** command. You can use the **show tunnel mac-table** command to see MAC table entries. You can use the **test tunnel mac-address** command to test the addition of MAC addresses to the MAC table of a tunnel interface.

VLAN on the Tunnel Interface

Mobile nodes connect to the wireless access points (APs). These APs have Service Set Identifiers (SSIDs) provided by the service provider. The SSID of a CPE is the VLAN identifier. The CPE can be configured to insert VLAN tags in Ethernet frames received from the mobile nodes before forwarding them on the GRE tunnel. Similarly, for downstream traffic, the GRE tunnel can be configured to insert a VLAN tag in all Ethernet frames sent to the MN.

A tunnel interface supports only one VLAN tag.

You can associate a VLAN with an Ethernet over GRE tunnel by using the **tunnel vlan** command.

How to Configure an Ethernet over GRE tunnel

Configuring an Ethernet over GRE Tunnel

SUMMARY STEPS

1. **interface tunnel** *tunnel-number*
2. **mac-address** *mac-address*
3. Do one of the following:
 - **ip address dhcp**
 - **ip address** *ip-address mask*
4. **tunnel source** {*ip-address* | *ipv6-address* | *interface-type interface-number*}
5. **tunnel mode ethernet gre** {*ipv4* | *ipv6*}
6. **tunnel key** *key*
7. **tunnel vlan** *vlan-id*
8. **end**

DETAILED STEPS

	Command or Action	Purpose
Step 1	interface tunnel <i>tunnel-number</i> Example: Device(config)# interface tunnel 1	Configures a tunnel interface and enters interface configuration mode.
Step 2	mac-address <i>mac-address</i> Example: Device(config-if)# mac-address 0000.0000.0001	(Optional) Specifies a MAC address for the tunnel.
Step 3	Do one of the following: <ul style="list-style-type: none"> • ip address dhcp • ip address <i>ip-address mask</i> Example: Device(config-if)# ip address 192.168.4.3 255.255.255.0 Example: Device(config-if)# ip address dhcp	<ul style="list-style-type: none"> • Specifies that the IP address of the mobile node is allocated by DHCP when it connects to the network. • Specifies the IPv4 address of the mobile node.
Step 4	tunnel source { <i>ip-address</i> <i>ipv6-address</i> <i>interface-type interface-number</i> } Example: Device(config-if)# tunnel source loopback 2	Sets the source address of a tunnel interface.

	Command or Action	Purpose
Step 5	tunnel mode ethernet gre {ipv4 ipv6} Example: Device(config-if)# tunnel mode ethernet gre ipv4	Sets the encapsulation mode of the tunnel to Ethernet over GRE IPv4 or GRE IPv6.
Step 6	tunnel key key Example: Device(config-if)# tunnel key 1	Enables an key identifier for the tunnel interface.
Step 7	tunnel vlan vlan-id Example: Device(config-if)# tunnel vlan 1	Associates a VLAN identifier with the Ethernet over GRE tunnel.
Step 8	end Example: end	Exits to privileged EXEC mode.

What to do next

Verify the tunnel.

Verifying Ethernet Over GRE Tunnel

Before you begin

Configure the Ethernet over GRE tunnel.

SUMMARY STEPS

1. **show interface tunnel**
2. **show tunnel mac-table**
3. **show tunnel endpoints**

DETAILED STEPS**Step 1** **show interface tunnel**

This command displays information about the tunnel.

Example:

```
Device# show interface tunnel 1
```

```
Tunnel1 is up, line protocol is up
Hardware is Tunnel
Internet address is 11.1.1.1/24
MTU 17846 bytes, BW 100 Kbit/sec, DLY 50000 usec, reliability 255/255, txload 1/255, rxload 1/255
Encapsulation TUNNEL, loopback not set
Keepalive not set
```



```

Tunnel source 10.0.0.1
Tunnel MAC address 0000.5e00.5213
Tunnel Vlan-id 1
Tunnel protocol/transport Ethernet-GRE/IP Key 0x1, sequencing disabled Checksumming of packets disabled
Tunnel TTL 255
Tunnel transport MTU 1454 bytes
Tunnel transmit bandwidth 8000 (kbps) Tunnel receive bandwidth 8000 (kbps)
Last input 00:48:08, output never, output hang never
Last clearing of "show interface" counters 00:48:26
Input queue: 0/375/0/0 (size/max/drops/flushes); Total output drops: 107
Queueing strategy: fifo
Output queue: 0/0 (size/max)
5 minute input rate 0 bits/sec, 0 packets/sec
5 minute output rate 0 bits/sec, 0 packets/sec
1867 packets input, 161070 bytes, 0 no buffer
Received 0 broadcasts (0 IP multicasts)
0 runts, 0 giants, 0 throttles
0 input errors, 0 CRC, 0 frame, 0 overrun, 0 ignored, 0 abort
43 packets output, 4386 bytes, 0 underruns
0 output errors, 0 collisions, 0 interface resets
0 unknown protocol drops
0 output buffer failures, 0 output buffers swapped out ind-uut#
--- 22:03:51 ---
44: 2013-01-30T22:03:51: %SCRIPT-6-INFO: {_haExecCmd: Executing cmd exec with ind-uut-a}

```

Device# **show interface tunnel 2**

```

Tunnel2 is up, line protocol is up
Hardware is Tunnel
Internet address is 10.1.1.1/24
MTU 1434 bytes, BW 100 Kbit/sec, DLY 50000 usec, reliability 255/255, txload 1/255, rxload 1/255
Encapsulation TUNNEL, loopback not set
Keepalive not set
Tunnel source 10::1
Tunnel MAC address 0000.5e00.5213
Tunnel Vlan-id 2
Tunnel protocol/transport Ethernet-GRE/IPv6
Key 0x2, sequencing disabled
Checksumming of packets disabled
Tunnel TTL 255
Path MTU Discovery, ager 10 mins, min MTU 1280
Tunnel transport MTU 1434 bytes
Tunnel transmit bandwidth 8000 (kbps) Tunnel receive bandwidth 8000 (kbps)
Last input never, output never, output hang never
Last clearing of "show interface" counters 00:48:28
Input queue: 0/375/0/0 (size/max/drops/flushes); Total output drops: 106
Queueing strategy: fifo
Output queue: 0/0 (size/max)
5 minute input rate 0 bits/sec, 0 packets/sec
5 minute output rate 0 bits/sec, 0 packets/sec
0 packets input, 0 bytes, 0 no buffer
Received 0 broadcasts (0 IP multicasts)
0 runts, 0 giants, 0 throttles
0 input errors, 0 CRC, 0 frame, 0 overrun, 0 ignored, 0 abort
0 packets output, 0 bytes, 0 underruns
0 output errors, 0 collisions, 0 interface resets
0 unknown protocol drops
0 output buffer failures, 0 output buffers swapped out

```

Step 2 **show tunnel mac-table**

This command displays MAC table entries associated with a tunnel.

Example:

```
Device# show tunnel mac-table tunnel0

CPE IP 1.1.1.1 Refcount 2 Base 0x2A98DD0000
  mac-address 0122.0111.0111 vlan 1
  mac-address 0011.1111.0001 vlan 2
CPE IP 3.3.3.3 Refcount 2 Base 0x12345678
  mac-address 1234.5678.9011 vlan 1
```

Step 3 show tunnel endpoints

This command displays tunnel endpoints and verifies if the tunnel has been created correctly.

Example:

```
Device# show tunnel endpoints

Tunnel0 running in Ethernet-GRE/IP mode

Endpoint transport 10.1.1.1 Refcount 3 Base 0x2A98DD03C0 Create Time 3d02h
  overlay 10.1.1.1 Refcount 2 Parent 0x2A98DD03C0 Create Time 3d02h
Endpoint transport 3.3.3.3 Refcount 3 Base 0x2A98DD0300 Create Time 3d02h
  overlay 10.1.1.3 Refcount 2 Parent 0x2A98DD0300 Create Time 3d02h
```

Configuration Examples for Ethernet over GRE Tunnels

Example: Configuring Ethernet over GRE Tunnels

Configuring Ethernet over GRE tunnels on the Mobile Node

```
! Configure the topology
mobile-node1(config-if)# interface GigabitEthernet0/1
mobile-node1(config-if)# ip address 10.21.1.1 255.255.255.0
mobile-node1(config-if)# no shut
mobile-node1(config-if)# exit
mobile-node1(config)# ip route 10.0.0.1 255.255.255.255 10.21.1.2

! Configuring the interface used as the source of the tunnel
mobile-node1(config)# interface Loopback0
mobile-node1(config-if)# ip address 10.40.0.1 255.255.255.0
mobile-node1(config-if)# ipv6 address 2001:db8:2:40::1/64
mobile-node1(config-if)# no shutdown

! Configuring the Ethernet over GRE IPv4 Tunnel
mobile-node1(config-if)# interface Tunnel1
mobile-node1(config-if)# mac-address 0000.0000.0001
mobile-node1(config-if)# ip dhcp client client-id ascii MN1@cisco.com
mobile-node1(config-if)# ip address dhcp
mobile-node1(config-if)# no ip redirects
mobile-node1(config-if)# no ip route-cache
mobile-node1(config-if)# tunnel source Loopback0
mobile-node1(config-if)# tunnel mode ethernet gre ipv4
mobile-node1(config-if)# tunnel key 1
mobile-node1(config-if)# tunnel vlan 1
```

```
mobile-nodel(config-if)# no shutdown
```

Configuring Ethernet over GRE tunnel on the MAG

```
! Configure the topology
MAG(config)# interface FastEthernet1/1/5
MAG(config-if)# ip address 10.21.1.2 255.255.255.0
MAG(config-if)# ipv6 address 2001:db8:2:21::2/64
MAG(config-if)# no shut
MAG(config)# ip route 10.40.0.1 255.255.255.255 10.21.1.1

! Configure the interface used as source of the tunnel
MAG(config-if)# interface Loopback0
MAG(config-if)# ip address 10.0.0.1 255.255.255.0
MAG(config-if)# no shutdown

! Configuring the Ethernet over GRE IPv4 Tunnel
MAG(config)# interface Tunnell
MAG(config-if)# ip address 10.11.1.1 255.255.255.0
MAG(config-if)# tunnel mode ethernet gre ipv4
MAG(config-if)# tunnel source 10.0.0.1

! Configuring a static GRE and VLAN ID for the tunnel
MAG(config-if)# tunnel key 1
MAG(config-if)# tunnel vlan 1

! Associating the service policy control with the tunnel
MAG(config-if)# service-policy type control DHCP1

! Enable ISG on the tunnel
MAG(config-if)# ip subscriber l2-connected
MAG(config-subscriber)# initiator unclassified mac-address
Please unconfigure existing command before configuring.
MAG(config-subscriber)# initiator dhcp class-aware
```

Additional References

Related Documents

Related Topic	Document Title
IPv6 addressing and connectivity	<i>Cisco IOS IPv6 Configuration Guide</i>
Cisco IOS commands	Cisco IOS Master Commands List, All Releases
IPv6 commands	Cisco IOS IPv6 Command Reference
Cisco IOS IPv6 features	Cisco IOS IPv6 Feature Mapping

Standard/RFC	Title
RFCs for IPv6	<i>IPv6 RFCs</i>

Standards and RFCs

Technical Assistance

Description	Link
The Cisco Support and Documentation website provides online resources to download documentation, software, and tools. Use these resources to install and configure the software and to troubleshoot and resolve technical issues with Cisco products and technologies. Access to most tools on the Cisco Support and Documentation website requires a Cisco.com user ID and password.	http://www.cisco.com/cisco/web/support/index.html

Feature Information for Ethernet over GRE Tunnels

The following table provides release information about the feature or features described in this module. This table lists only the software release that introduced support for a given feature in a given software release train. Unless noted otherwise, subsequent releases of that software release train also support that feature.

Use Cisco Feature Navigator to find information about platform support and Cisco software image support. To access Cisco Feature Navigator, go to www.cisco.com/go/cfn. An account on Cisco.com is not required.

Table 26: Feature Information for Ethernet over GRE Tunnels

Feature Name	Releases	Feature Information
Ethernet over GRE Tunnels	Cisco IOS XE Release 3.9S	<p>The Ethernet over GRE tunnels feature allows customers to leverage existing low-end residential gateways to provide mobility services to mobile nodes using Proxy Mobile IPv6 (PMIPv6), GPRS Tunneling Protocol (GTP) and Intelligent Service Gateway (ISG).</p> <p>The following command was modified to add the Ethernet over GRE tunnel mode for IPv4 and IPv6: tunnel mode ethernet gre.</p> <p>The following commands were introduced: tunnel vlan, show tunnel mac-table, show tunnel source tracking, test tunnel mac-address.</p>



CHAPTER 21

QoS on Ethernet over GRE Tunnels

The QoS on Ethernet over GRE (EoGRE) Tunnels feature enables service providers to configure one common Quality of Service (QoS) policy for all endpoints, where an end-point can be a customer premise equipment (CPE) or a VLAN on a CPE. This feature supports high availability on a route processor.

- [Finding Feature Information, on page 207](#)
- [Information About QoS on Ethernet over GRE Tunnels, on page 207](#)
- [How to Configure QoS on Ethernet over GRE Tunnels, on page 209](#)
- [Configuration Examples for QoS on Ethernet over GRE Tunnels, on page 213](#)
- [Additional References for QoS on Ethernet over GRE Tunnels, on page 215](#)
- [Feature Information for QoS on Ethernet over GRE Tunnels, on page 215](#)

Finding Feature Information

Your software release may not support all the features documented in this module. For the latest caveats and feature information, see [Bug Search Tool](#) and the release notes for your platform and software release. To find information about the features documented in this module, and to see a list of the releases in which each feature is supported, see the feature information table.

Use Cisco Feature Navigator to find information about platform support and Cisco software image support. To access Cisco Feature Navigator, go to www.cisco.com/go/cfn. An account on Cisco.com is not required.

Information About QoS on Ethernet over GRE Tunnels

EoGRE Downstream QoS

The Quality of Service (QoS) on Ethernet over GRE (EoGRE) Tunnels feature enables service providers to apply a unified QoS policy on all endpoints of a tunnel. This controls the bandwidth that public subscribers can download and ensures maximum bandwidth for private customers.

In the deployment scenario given in the figure below, the total available WAN bandwidth at the customer premise equipment (CPE) is 10 Mbps, of which public users are allowed 2 Mbps and the remaining bandwidth is available for private users.

Figure 16: EoGRE Downstream QoS Use Case

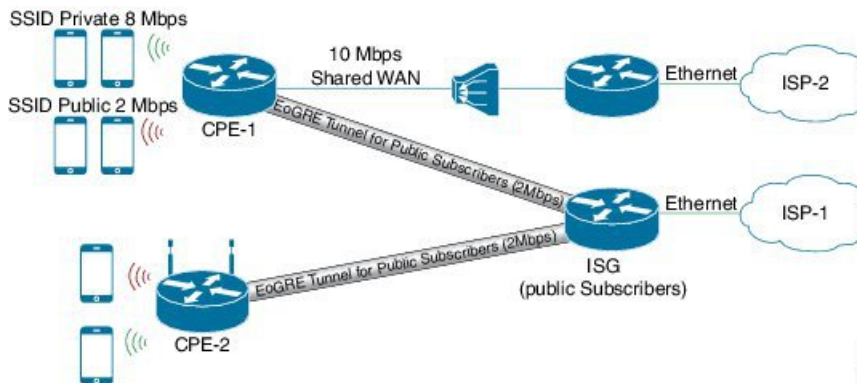

Single SSID

Mobile nodes connect to wireless access points (APs). These APs have Service Set Identifiers (SSIDs) provided by the service provider. The SSID of a customer premise equipment (CPE) is the VLAN identifier. Service providers can provide more than one public SSID at a CPE. If a CPE has more than one SSID, then additional mGRE tunnels are configured with a corresponding VLAN tag. The configured multipoint generic routing encapsulation (mGRE) tunnels learn about remote subscribers and the corresponding CPEs independently. This ensures that VLANs, their subnets, default gateways, and VRFs are kept separate and independent of each other, and any QoS policy that is configured on each endpoint of these tunnels also applies to the traffic from the VLAN on the CPE.

Figure 17: Separate Tunnels for Each SSID

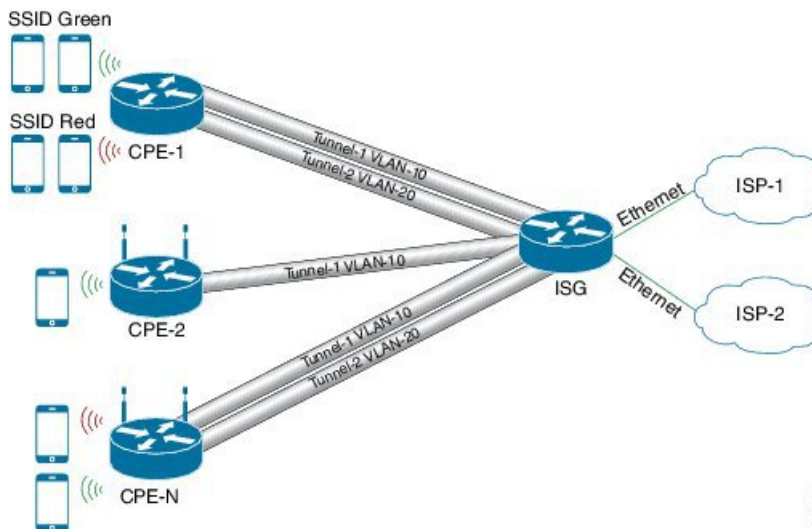

Multiple SSIDs

In a single tunnel for a multiple Service Set Identifiers (SSID), service providers can configure a VLAN range on the multipoint generic routing encapsulation (mGRE) tunnel. When a subscriber traffic is received, the traffic is matched according to the tunnel source and the VLAN range. The Ethernet over GRE (EoGRE)

control process also learns the MAC address of subscribers and the VLAN tag of the CPE from which the traffic is originating.



Note You cannot change a VLAN configuration if any subscriber session or MAC address is already learned in the EoGRE control process. To change the VLAN configurations, you must clear all subscriber sessions.

In the figure below, all endpoints learned on Tunnel-1 represent a CPE and a Quality of Service (QoS) policy applied on this tunnel endpoint applies to all traffic going towards the CPE irrespective of the VLAN.

Figure 18: Single Tunnel for Multiple SSIDs

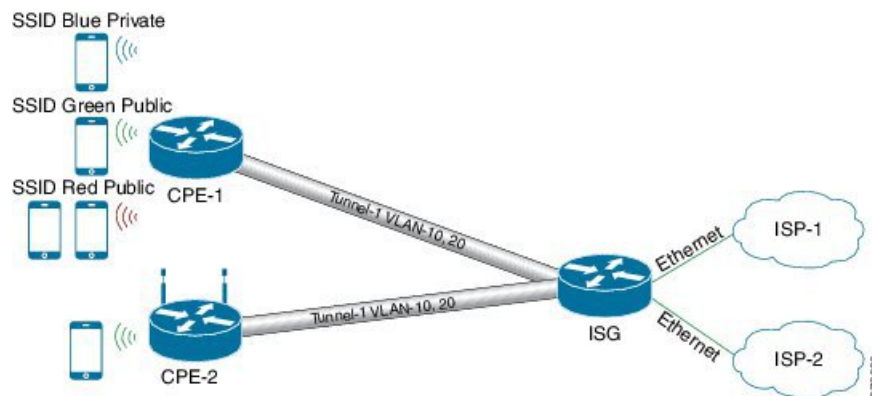

How to Configure QoS on Ethernet over GRE Tunnels

Configuring Downstream QoS Policy on Ethernet over GRE Tunnels

Before you begin

Create a Quality of Service (QoS) policy map to attach to the Ethernet over GRE (EoGRE) tunnel.



Note How to create a QoS policy map is not described in the following task.

SUMMARY STEPS

1. **enable**
2. **configure terminal**
3. **interface tunnel** *tunnel-number*
4. **interface source** {*ip-address* | *ipv6-address* | *interface-type interface-number*}
5. **tunnel vlan** *vlan-id*
6. **ip address** *ip-address mask*
7. **tunnel mode ethernet gre** {*ipv4* | *ipv6*}
8. **tunnel endpoint service-policy output** *policy-map-name*

9. **ip subscriber l2-connected**
10. **initiator unclassified mac-address**
11. **initiator dhcp**
12. **end**

DETAILED STEPS

	Command or Action	Purpose
Step 1	enable Example: Device> enable	Enables privileged EXEC mode. • Enter your password if prompted.
Step 2	configure terminal Example: Device# configure terminal	Enters global configuration mode.
Step 3	interface tunnel <i>tunnel-number</i> Example: Device(config)# interface tunnel 1	Specifies a tunnel interface and number and enters interface configuration mode.
Step 4	interface source { <i>ip-address</i> <i>ipv6-address</i> <i>interface-type interface-number</i> } Example: Device(config-if)# tunnel source loopback 2	Sets the source address of a tunnel interface.
Step 5	tunnel vlan <i>vlan-id</i> Example: Device(config-if)# tunnel vlan 10, 20	Associates a VLAN identifier with the Ethernet over GRE tunnel.
Step 6	ip address <i>ip-address mask</i> Example: Device(config-if)# ip address 192.168.4.3 255.255.255.0	Specifies the IP address and mask of the mobile node.
Step 7	tunnel mode ethernet gre { <i>ipv4</i> <i>ipv6</i> } Example: Device(config-if)# tunnel mode ethernet gre ipv4	Sets the encapsulation mode of the tunnel to Ethernet over GRE IPv4 or GRE IPv6.
Step 8	tunnel endpoint service-policy output <i>policy-map-name</i> Example: Device(config-if)# tunnel endpoint service-policy output tunnel-qos-policy	Configures the QoS policy for tunnel endpoints.
Step 9	ip subscriber l2-connected Example: Device(config-if)# ip subscriber l2-connected	Enters IP subscriber configuration mode.

	Command or Action	Purpose
Step 10	initiator unclassified mac-address Example: Device(config-subscriber)# initiator unclassified mac-address	Initiates IP sessions from unclassified MAC address.
Step 11	initiator dhcp Example: Device(config-subscriber)# initiator dhcp	Enables IP sessions initiated by DHCP.
Step 12	end Example: Device(config-subscriber)# end	Exits to global configuration mode.

Verifying QoS on Ethernet over GRE Tunnels

The **show** commands can be entered in any order.

Before you begin

Configure QoS on Ethernet over GRE (EoGRE) tunnel.

SUMMARY STEPS

1. **show interface tunnel** *tunnel-interface*
2. **show tunnel endpoints tunnel** *tunnel-interface*
3. **show tunnel mac-table tunnel** *tunnel-interface*
4. **show policy-map multipoint tunnel** *tunnel-interface*

DETAILED STEPS

Step 1 **show interface tunnel** *tunnel-interface*

This command displays information about the tunnel.

Example:

```
Device# show interface tunnel 1
```

```
Tunnel1 is up, line protocol is up
Hardware is Tunnel
Internet address is 11.1.1.1/24
MTU 17846 bytes, BW 100 Kbit/sec, DLY 50000 usec, reliability 255/255, txload 1/255, rxload 1/255
Encapsulation TUNNEL, loopback not set
Keepalive not set
Tunnel source 10.0.0.1
Tunnel MAC address 0000.5e00.5213
Tunnel Vlan-id 1
Tunnel protocol/transport Ethernet-GRE/IP Key 0x1, sequencing disabled Checksumming of packets disabled
Tunnel TTL 255
Tunnel transport MTU 1454 bytes
```

```

Tunnel transmit bandwidth 8000 (kbps) Tunnel receive bandwidth 8000 (kbps)
Last input 00:48:08, output never, output hang never
Last clearing of "show interface" counters 00:48:26
Input queue: 0/375/0/0 (size/max/drops/flushes); Total output drops: 107
Queueing strategy: fifo
Output queue: 0/0 (size/max)
5 minute input rate 0 bits/sec, 0 packets/sec
5 minute output rate 0 bits/sec, 0 packets/sec
1867 packets input, 161070 bytes, 0 no buffer
Received 0 broadcasts (0 IP multicasts)
0 runts, 0 giants, 0 throttles
0 input errors, 0 CRC, 0 frame, 0 overrun, 0 ignored, 0 abort
43 packets output, 4386 bytes, 0 underruns
0 output errors, 0 collisions, 0 interface resets
0 unknown protocol drops
0 output buffer failures, 0 output buffers swapped out ind-ut#
--- 22:03:51 ---
44: 2013-01-30T22:03:51: %SCRIPT-6-INFO: {_haExecCmd: Executing cmd exec with ind-ut-a}

```

```
Device# show interface tunnel 2
```

```

Tunnel2 is up, line protocol is up
Hardware is Tunnel
Internet address is 10.1.1.1/24
MTU 1434 bytes, BW 100 Kbit/sec, DLY 50000 usec, reliability 255/255, txload 1/255, rxload 1/255
Encapsulation TUNNEL, loopback not set
Keepalive not set
Tunnel source 10::1
Tunnel MAC address 0000.5e00.5213
Tunnel Vlan-id 2
Tunnel protocol/transport Ethernet-GRE/IPv6
Key 0x2, sequencing disabled
Checksumming of packets disabled
Tunnel TTL 255
Path MTU Discovery, ager 10 mins, min MTU 1280
Tunnel transport MTU 1434 bytes
Tunnel transmit bandwidth 8000 (kbps) Tunnel receive bandwidth 8000 (kbps)
Last input never, output never, output hang never
Last clearing of "show interface" counters 00:48:28
Input queue: 0/375/0/0 (size/max/drops/flushes); Total output drops: 106
Queueing strategy: fifo
Output queue: 0/0 (size/max)
5 minute input rate 0 bits/sec, 0 packets/sec
5 minute output rate 0 bits/sec, 0 packets/sec
0 packets input, 0 bytes, 0 no buffer
Received 0 broadcasts (0 IP multicasts)
0 runts, 0 giants, 0 throttles
0 input errors, 0 CRC, 0 frame, 0 overrun, 0 ignored, 0 abort
0 packets output, 0 bytes, 0 underruns
0 output errors, 0 collisions, 0 interface resets
0 unknown protocol drops
0 output buffer failures, 0 output buffers swapped out

```

Step 2 **show tunnel endpoints tunnel *tunnel-interface***

This command displays tunnel interface endpoints and verifies if the tunnel is created correctly.

Example:

```

Device# show tunnel endpoints tunnel

Tunnel0 running in Ethernet-GRE/IP mode

Endpoint transport 10.1.1.1 Refcount 3 Base 0x2A98DD03C0 Create Time 3d02h

```

```

overlay 10.1.1.1 Refcount 2 Parent 0x2A98DD03C0 Create Time 3d02h
Endpoint transport 3.3.3.3 Refcount 3 Base 0x2A98DD0300 Create Time 3d02h
overlay 10.1.1.3 Refcount 2 Parent 0x2A98DD0300 Create Time 3d02h

```

Step 3 **show tunnel mac-table tunnel** *tunnel-interface*

This command displays MAC table entries that are associated with a tunnel.

Example:

```

Device# show tunnel mac-table tunnel0

overlay-address 30.0.0.21, transport-address 192.168.0.50
mac-address 0000.1200.0001, vlan 400 Mac Age 3d06h

overlay-address 60.0.0.8, transport-address 120.0.40.2
mac-address 3010.e495.b058, vlan 10 Mac Age 00:01:00

```

Step 4 **show policy-map multipoint tunnel** *tunnel-interface*

This command displays the policy-map that is associated with a tunnel.

Example:

```

Device> show policy-map multipoint tunnel 1

Interface Tunnel 1 <--> 1.1.1.1
Service-policy output: test
  Class-map: class-default (match-any)
    0 packets, 0 bytes
    5 minute offered rate 0000 bps, drop rate 0000 bps
  Match: any
  police:rate 300000 bps, burst 17898 bytes
    conformed 0 packets, 0 bytes;actions:transmit
  exceeded 0 packets, 0 bytes; actions:drop
    conformed 0000 bps, exceeded 0000 bps

```

Configuration Examples for QoS on Ethernet over GRE Tunnels

Example: QoS on Ethernet over GRE Tunnels

Configuring Ethernet over GRE (EoGRE) on the mobile node.

```

! configure the topology
mobile-nodel(config-if)# interface GigabitEthernet0/1
mobile-nodel(config-if)# ip address 10.21.1.1 255.255.255.0
mobile-nodel(config-if)# no shutdown
mobile-nodel(config-if)# exit
mobile-nodel(config)# ip route 10.0.0.1 255.255.255.255 10.21.1.2

! Configure the interface used as the source of the tunnel
mobile-nodel(config)# interface Loopback0
mobile-nodel(config-if)# ip address 10.40.0.1 255.255.255.0
mobile-nodel(config-if)# ipv6 address 2001:db8:2:40::1/64
mobile-nodel(config-if)# no shutdown

```

Example: QoS on Ethernet over GRE Tunnels

```

! Configure the Ethernet over GRE IPv4 Tunnel
mobile-node1(config-if)# interface Tunnell
mobile-node1(config-if)# mac-address 0000.0000.0001
mobile-node1(config-if)# ip dhcp client client-id ascii MN1@cisco.com
mobile-node1(config-if)# ip address dhcp
mobile-node1(config-if)# no ip redirects
mobile-node1(config-if)# no ip route-cache
mobile-node1(config-if)# tunnel source Loopback0
mobile-node1(config-if)# tunnel mode ethernet gre ipv4
mobile-node1(config-if)# tunnel key 1
mobile-node1(config-if)# tunnel vlan 10, 20
mobile-node1(config-if)# no shutdown
mobile-node1(config-if)# exit

Configuring Ethernet over GRE tunnel on the MAG

! Configure the topology
MAG(config)# interface FastEthernet1/1/5
MAG(config-if)# ip address 10.21.1.2 255.255.255.0
MAG(config-if)# ipv6 address 2001:db8:2:21::2/64
MAG(config-if)# no shutdown
MAG(config)# ip route 10.40.0.1 255.255.255.255 10.21.1.1

! Configure the interface used as source of the tunnel
MAG(config-if)# interface Loopback0
MAG(config-if)# ip address 10.0.0.1 255.255.255.0
MAG(config-if)# no shutdown

! configure the policy map
MAG(config)# policy-map tunnel-qos-policy
MAG(config-pmap)# class class-default
MAG(config-pmap-c)# police rate 200000 bps
MAG(config-pmap-c)# exit

! Configure the Ethernet over GRE IPv4 Tunnel
MAG(config)# interface Tunnell
MAG(config-if)# ip address 10.11.1.1 255.255.255.0
MAG(config-if)# tunnel mode ethernet gre ipv4
MAG(config-if)# tunnel source Loopback0

! Configure a static GRE and VLAN ID for the tunnel
MAG(config-if)# tunnel key 1
MAG(config-if)# tunnel vlan 10, 20

!Associate the QoS policy to the tunnel interface
MAG(config-if)# tunnel endpoint service-policy output tunnel-qos-policy

! Enable ISG on the tunnel
MAG(config-if)# ip subscriber l2-connected
MAG(config-subscriber)# initiator unclassified mac-address
MAG(config-subscriber)# initiator dhcp
MAG(config-subscriber)# exit

```

Additional References for QoS on Ethernet over GRE Tunnels

Related Documents

Related Topic	Document Title
Cisco IOS commands	Cisco IOS Master Command List, All Releases
Ethernet over GRE Tunnels	<i>Cisco IOS Interface and Hardware Component Configuration Guide</i>
Tunnel commands: complete command syntax, command mode, defaults, command history, usage guidelines, and examples	Interface and Hardware Component Command Reference

Technical Assistance

Description	Link
<p>The Cisco Support website provides extensive online resources, including documentation and tools for troubleshooting and resolving technical issues with Cisco products and technologies.</p> <p>To receive security and technical information about your products, you can subscribe to various services, such as the Product Alert Tool (accessed from Field Notices), the Cisco Technical Services Newsletter, and Really Simple Syndication (RSS) Feeds.</p> <p>Access to most tools on the Cisco Support website requires a Cisco.com user ID and password.</p>	http://www.cisco.com/cisco/web/support/index.html

Feature Information for QoS on Ethernet over GRE Tunnels

The following table provides release information about the feature or features described in this module. This table lists only the software release that introduced support for a given feature in a given software release train. Unless noted otherwise, subsequent releases of that software release train also support that feature.

Use Cisco Feature Navigator to find information about platform support and Cisco software image support. To access Cisco Feature Navigator, go to www.cisco.com/go/cfn. An account on Cisco.com is not required.

Table 27: Feature Information for QoS on Ethernet over GRE Tunnels

Feature Name	Releases	Feature Information
QoS on Ethernet over GRE Tunnels	Cisco IOS XE 3.13S	<p>The QoS on Ethernet over GRE (EoGRE) Tunnels feature enables service providers to configure a common QoS policy for all endpoints. This feature supports dual high availability for a route processor.</p> <p>The following command was introduced by this feature: tunnel endpoint service-policy output.</p>



CHAPTER 22

VRF-Aware IPv6 Rapid Deployment Tunnel

Virtual Routing and Forwarding - aware tunnels are used to connect customer networks separated by untrusted core networks or core networks with different infrastructures (IPv4 or IPv6). The VRF-Aware IPv6 Rapid Deployment Tunnel feature extends Virtual Routing and Forwarding (VRF) awareness to IPv6 rapid deployment tunnels.

- [Finding Feature Information, on page 217](#)
- [Restrictions for the VRF-Aware IPv6 Rapid Deployment Tunnel, on page 217](#)
- [Information About the VRF-Aware IPv6 Rapid Deployment Tunnel, on page 218](#)
- [How to Configure the VRF-Aware IPv6 Rapid Deployment Tunnel, on page 218](#)
- [Additional References, on page 226](#)
- [Feature Information for the VRF-Aware IPv6 Rapid Deployment Tunnel , on page 227](#)

Finding Feature Information

Your software release may not support all the features documented in this module. For the latest feature information and caveats, see the release notes for your platform and software release. To find information about the features documented in this module, and to see a list of the releases in which each feature is supported, see the feature information table at the end of this module.

Use Cisco Feature Navigator to find information about platform support and software image support. To access Cisco Feature Navigator, go to <http://www.cisco.com/go/cfn>. An account on Cisco.com is not required.

Restrictions for the VRF-Aware IPv6 Rapid Deployment Tunnel

The VRF- Aware IPv6 Rapid Deployment Tunnel feature has the following restrictions:

- The incoming physical interface, and the tunnel interface should have the same VRF instance defined.
- The tunnel transport VRF and the egress physical interface, through which the traffic leaves should have the same VRF instance defined.
- For IPv6 rapid deployment Customer Edge (CE) router configuration, the tunnel source and the Border Relay (BR) router address should have the same VRF instance defined as the physical interface through which the traffic flows.

Information About the VRF-Aware IPv6 Rapid Deployment Tunnel

The IPv6 Rapid Deployment Tunnel feature allows a service provider to provide a unicast IPv6 service to customers over its IPv4 network by using encapsulation of IPv6 in IPv4. Currently, the IPv6 Rapid Deployment Tunnel feature does not support VRF. Therefore, the forwarding table look up tasks for locating IPv6 overlay addresses and IPv4 transport addresses are performed in the global routing table. The VRF-Aware IPv6 Rapid Deployment Tunnel feature extends the IPv6 rapid deployment tunneling support for IPv6 overlay addresses and IPv4 transport addresses in VRF.

The following scenarios are supported for VRF-Aware IPv6 Rapid Deployment Tunnel feature:

- The IPv6 rapid deployment tunnel is in the VRF and both IPv6 overlay address and the IPv4 transport address are in VRF.
- IPv6 rapid deployment tunnel and the IPv4 address are in VRF. The incoming global routing table IPv6 traffic selects the correct VRF, based on the IPv6 rapid deployment domain.

The following figure explains the topology and sample configurations for the VRF Aware IPv6 Rapid Deployment Tunnel feature where both the IPv4 addresses and IPv6 addresses are in VRF.

Figure 19: Topology of the VRF-Aware IPv6 Rapid Deployment Tunnel

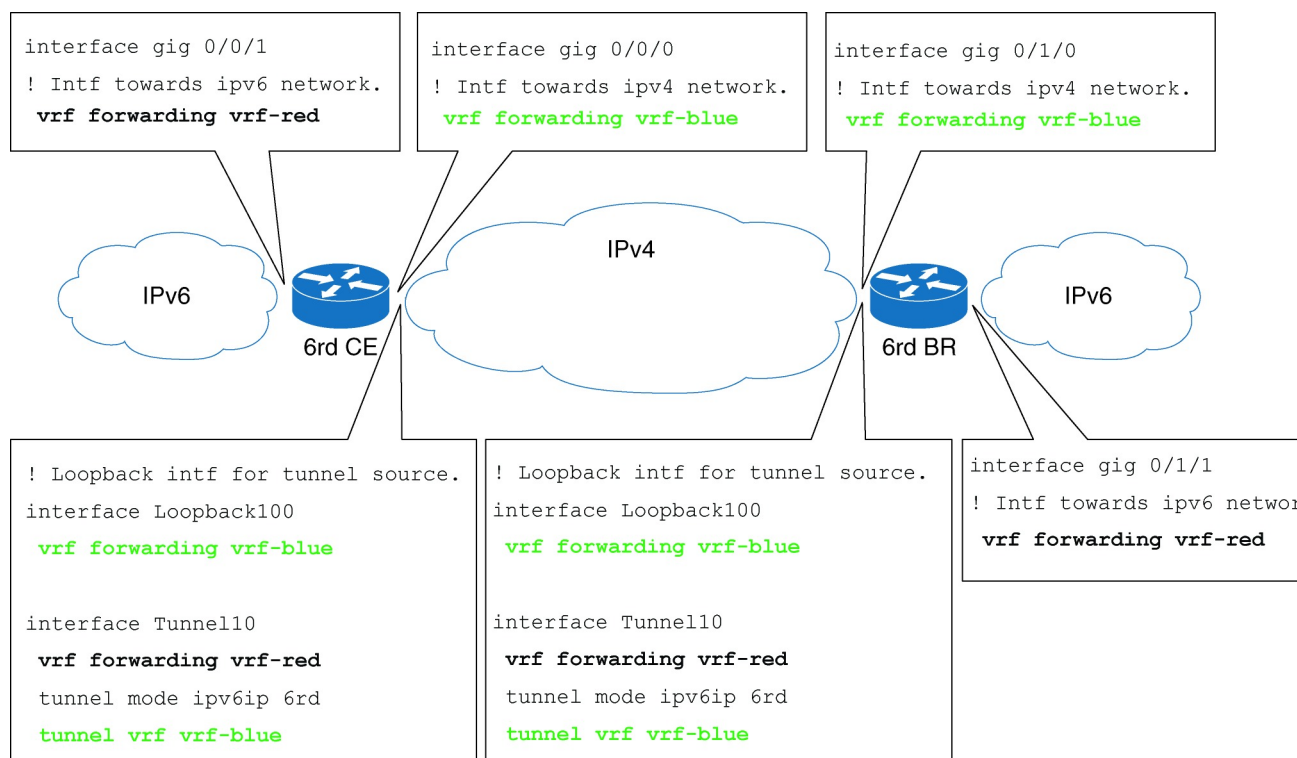

How to Configure the VRF-Aware IPv6 Rapid Deployment Tunnel

Complete the steps in the following procedure to configure the VRF-Aware IPv6 Rapid Deployment Tunnel feature when both the IPv6 and IPv4 addresses are in VRF. You should perform these steps on the CE router and BR router unless specifically mentioned otherwise in the following procedure.

Configuring the VRF-Aware IPv6 Rapid Deployment Tunnel

SUMMARY STEPS

1. **enable**
2. **configure terminal**
3. **ipv6 unicast-routing**
4. **vrf definition** *vrf-name1*
5. **rd** {*ASN:nn* | *IP address: nn*}
6. **route-target** [**import** | **export** | **both**] {*ASN:nn* | *IP address: nn*}
7. **address-family ipv6**
8. **exit**
9. **address-family ipv4**
10. **exit**
11. **exit**
12. **vrf definition** *vrf-name2*
13. **rd** {*ASN:nn* | *IP address: nn*}
14. **route-target** [**import** | **export** | **both**] {*ASN:nn* | *IP address: nn*}
15. **address-family ipv4**
16. **exit**
17. **exit**
18. **interface gigabitethernet** *slot / port*
19. **vrf forwarding** *vrf-name1*
20. **ipv6 address** {*ipv6-address prefix-length prefix-name sub-bits prefix-length*}
21. **exit**
22. **interface gigabitethernet** *slot / port*
23. **vrf forwarding** *vrf-name2*
24. **ip address** *ip-address mask*
25. **exit**
26. **interface loopback** *interface-number*
27. **vrf forwarding** *vrf-name2*
28. **ip address** *ip-address*
29. **exit**
30. **interface tunnel** *tunnel-number*
31. **vrf forwarding** *vrf-name1*
32. **ipv6 address** {*ipv6-address prefix-length prefix-name sub-bits prefix-length*}
33. **tunnel source** {*ip-address* | *interface-type interface-number*}
34. **tunnel mode ipv6ip** [**6rd** | **6to4** | **auto-tunnel** | **isatap**]
35. **tunnel 6rd ipv4** {**prefix-length** *length*} {**suffix-length** *length*}
36. **tunnel 6rd prefix** {*ipv6-prefix/ prefix-length*}
37. **tunnel 6rd br** *ipv4-address*
38. **tunnel vrf** *vrf-name2*
39. **exit**
40. **ipv6 route vrf** *vrf-name1* {*ipv6-prefix / prefix-length*} **tunnel** *tunnel-number*
41. **ipv6 route vrf** *vrf-name1* {*ipv6-prefix/ prefix-length*} **tunnel** *tunnel-number* *ipv6-address*

42. end

DETAILED STEPS

	Command or Action	Purpose
Step 1	enable Example: Router# enable	Enables the privileged EXEC mode. Enter your password if prompted.
Step 2	configure terminal Example: Router# configure terminal	Enters the global configuration mode.
Step 3	ipv6 unicast-routing Example: Router(config)# ipv6 unicast-routing	Enables the task of forwarding IPv6 unicast datagrams.
Step 4	vrf definition <i>vrf-name1</i> Example: Router(config)# vrf definition VRF_RED	Configures a VRF instance and enters the VRF configuration mode.
Step 5	rd { <i>ASN:nn</i> <i>IP address: nn</i> } Example: Router(config-vrf)# rd 1:1	Specifies a route distinguisher. <ul style="list-style-type: none"> • <i>ASN:nn</i> — Specifies an autonomous system number and an arbitrary number. • <i>IP address: nn</i> — Specifies an IP address and an arbitrary number.
Step 6	route-target [import export both] { <i>ASN:nn</i> <i>IP address: nn</i> } Example: Router(config-vrf)# route-target import 1:1	Creates a route target extended community for a VRF instance. Route target extended community attributes are used to identify a set of sites and VRF instances that can receive routes with a configured route target. <ul style="list-style-type: none"> • import — Imports routing information from the target VPN extended community. • export — Exports routing information to the target VPN extended community. • both — Imports both import and export routing information to the target VPN extended community • <i>ASN:nn</i> — Specifies an autonomous system number and an arbitrary number. • <i>IP address: nn</i> — Specifies an IP address and an arbitrary number.

	Command or Action	Purpose
Step 7	address-family ipv6 Example: Router(config-vrf)# address-family ipv6	Selects IPv6 as address family type for a VRF table and enters VRF address family configuration mode. Configures separate route-target policies for IPv6.
Step 8	exit Example: Router(config-vrf-af)# exit	Exits the address family configuration mode.
Step 9	address-family ipv4 Example: Router(config-vrf)# address-family ipv4	Selects IPv4 as address family type for a VRF table and enters VRF address family configuration mode. Configures the separate route-target policies for IPv4.
Step 10	exit Example: Router(config-vrf-af)# exit	Exits the address family configuration mode.
Step 11	exit Example: Router(config-vrf)# exit	Exits the VRF configuration mode.
Step 12	vrf definition vrf-name2 Example: Router(config)# vrf definition VRF_GREEN	Configures a VRF instance and enters the VRF configuration mode.
Step 13	rd {ASN:nn IP address: nn} Example: Router(config-vrf)# rd 1:1	Specifies a route distinguisher.
Step 14	route-target [import export both] {ASN:nn IP address: nn} Example: Router(config-vrf)# route-target import 1:1	Creates a route-target extended community for a VRF instance. Route-target extended community attributes are used to identify a set of sites and VRF instances that can receive routes with a configured route target <ul style="list-style-type: none"> • import — Imports routing information from the target VPN extended community. • export — Exports routing information to the target VPN extended community. • both — Imports and exports routing information to the target VPN extended community and from the target VPN extended community. • <i>ASN:nn</i> — Specifies an autonomous system number and an arbitrary number. • <i>IP address: nn</i> — Specifies an IP address and an arbitrary number.

	Command or Action	Purpose
Step 15	address-family ipv4 Example: Router(config-vrf)# address-family ipv4	Selects IPv4 as address family for a VRF table and enters the VRF address family configuration mode. Configures separate route-target policies for IPv4.
Step 16	exit Example: Router(config-vrf-af)# exit	Exits the address family configuration mode.
Step 17	exit Example: Router(config-vrf)# exit	Exits the VRF configuration mode.
Step 18	interface gigabitethernet slot / port Example: Router(config)# interface gigabitethernet 3/1	Enters the interface configuration mode and specifies the Gigabit interface to configure.
Step 19	vrf forwarding vrf-name1 Example: Router(config-if)# vrf forwarding VRF_RED	Associates a VRF instance with an interface or a subinterface.
Step 20	ipv6 address {ipv6-address prefix-length prefix-name sub-bits prefix-length} Example: Router(config-if)# ipv6 address 1::2/64	Specifies the IPv6 address assigned to the interface, and enables IPv6 processing on the interface.
Step 21	exit Example: Router(config-if)# exit	Exits the interface configuration mode.
Step 22	interface gigabitethernet slot / port Example: Router(config)# interface gigabitethernet 4/5	Enters the interface configuration mode and specifies the Gigabit interface to configure.
Step 23	vrf forwarding vrf-name2 Example: Router(config-if)# vrf forwarding VRF_GREEN	Associates a VRF instance with an interface or a subinterface.
Step 24	ip address ip-address mask Example: Router(config-if)# ip address 17.1.1.1 255.255.255.0	Assigns an IP address and subnet mask to the interface.
Step 25	exit Example: exit	Exits the interface configuration mode.

	Command or Action	Purpose
Step 26	interface loopback <i>interface-number</i> Example: <pre>Router(config)# interface Loopback 100</pre>	Enters the interface configuration mode and specifies the new loopback interface.
Step 27	vrf forwarding <i>vrf-name2</i> Example: <pre>Router(config-if)# vrf forwarding VRF_GREEN</pre>	Associates a VRF instance with an interface or a subinterface.
Step 28	ip address <i>ip-address</i> Example: <pre>Router(config-if)# ip address 60.1.1.1 255.255.255.0</pre>	Assigns an IP address and subnet mask to the loopback interface.
Step 29	exit Example: <pre>Router(config-if)# exit</pre>	Exits the interface configuration mode.
Step 30	interface tunnel <i>tunnel-number</i> Example: <pre>Router(config)# interface tunnel 10</pre>	Specifies a tunnel interface and enters the interface configuration mode.
Step 31	vrf forwarding <i>vrf-name1</i> Example: <pre>Router(config-if)# vrf forwarding VRF_RED</pre>	Associates a VRF instance with an interface or a subinterface.
Step 32	ipv6 address { <i>ipv6-address prefix-length prefix-name sub-bits prefix-length</i> } Example: <pre>Router(config-if)# ipv6 address 2001:A000:100::1/128</pre>	Specifies the IPv6 address assigned to the interface and enables IPv6 processing on the interface.
Step 33	tunnel source { <i>ip-address interface-type interface-number</i> } Example: <pre>Router(config-if)# tunnel source loopback 100</pre>	Specifies the source interface type and number for the tunnel interface.
Step 34	tunnel mode ipv6ip [<i>6rd 6to4 auto-tunnel isatap</i>] Example: <pre>Router(config-if)# tunnel mode ipv6ip 6rd</pre>	Configures a static IPv6 tunnel interface.
Step 35	tunnel 6rd ipv4 { <i>prefix-length length</i> } { <i>suffix-length length</i> } Example: <pre>Router(config-if)# tunnel 6rd ipv4 prefix-len 16 suffix-len 8</pre>	Specifies the prefix and suffix length of the IPv4 transport address that is common to all the 6rd tunnels.

	Command or Action	Purpose
Step 36	tunnel 6rd prefix <i>{ipv6-prefix/ prefix-length}</i> Example: Router(config-if)# tunnel 6rd prefix 2001:A000::/32	Specifies the common IPv6 prefix on IPv6 6rd tunnels.
Step 37	tunnel 6rd br <i>ipv4-address</i> Example: Router(config-if)# tunnel 6rd br 60.1.2.1	Bypasses security checks on a 6rd CE router. <ul style="list-style-type: none"> • <i>ipv4-address</i> — IPv4 address of the border relay (BR) router. Note Perform this step only on a CE router, not on a BR router.
Step 38	tunnel vrf <i>vrf-name2</i> Example: Router(config-if)# tunnel vrf VRF_GREEN	Configures a VRF instance with a specific tunnel destination, interface, or a subinterface. Note This command specifies the VRF instance used for the tunnel IPv4 transport address lookup.
Step 39	exit Example: Router(config-if)# exit	Exits interface configuration mode.
Step 40	ipv6 route vrf <i>vrf-name1 {ipv6-prefix / prefix-length}</i> tunnel <i>tunnel-number</i> Example: Router(config)# ipv6 route vrf VRF_RED 2001:A000::/32 Tunnel10	Establishes static routes. <ul style="list-style-type: none"> • <i>ipv6-prefix</i> — Specifies the IPv6 network that is the destination of the static route. Can also be a host name when static host routes are configured. • <i>ipv6-address</i> — The IPv6 address of the next hop that can be used to reach the specified network..
Step 41	ipv6 route vrf <i>vrf-name1 {ipv6-prefix/ prefix-length}</i> tunnel <i>tunnel-number ipv6-address</i> Example: Router(config)# ipv6 route vrf VRF_RED 9000:1000::/64 Tunnel10 2001:A000:200::1	Establishes static routes. <ul style="list-style-type: none"> • <i>ipv6-prefix</i> — Specifies the IPv6 network that is the destination of the static route. Can also be a host name when static host routes are configured. • <i>prefix-length</i> — Specifies the length of the IPv6 prefix.
Step 42	end Example: Router(config)# end	Ends the current configuration session.

Example: Configuring VRF- Aware IPv6 Rapid Deployment Tunnel

The following example shows how to configure the VRF-Aware IPv6 Rapid Deployment Tunnel on a CE router:

```

Router# enable
Router# configure terminal
Router(config)# ipv6 unicast-routing
Router(config)# mls ipv6 vrf
Router(config)# vrf definition VRF_RED
Router(config-vrf)# rd 1:1
Router(config-vrf)# route-target export 1:1
Router(config-vrf)# route-target import 1:1
Router(config-vrf)# address-family ipv6
Router(config-vrf-af)# exit
Router(config-vrf)# address-family ipv4
Router(config-vrf-af)# exit
Router(config-vrf)# exit
Router(config)# vrf definition VRF_GREEN
Router(config-vrf)# rd 1:1
Router(config-vrf)# route-target export 1:1
Router(config-vrf)# route-target import 1:1
Router(config-vrf)# address-family ipv4
Router(config-vrf-af)# exit
Router(config-vrf)# exit
Router(config)# interface gigabitethernet 3/1
Router(config-if)# vrf forwarding VRF_RED
Router(config-if)# ipv6 address 1::2/64
Router(config-if)# exit
Router(config)# interface gigabitethernet 4/5
Router(config-if)# vrf forwarding VRF_GREEN
Router(config-if)# ip address 17.1.1.1 255.255.255.0
Router(config-if)# ip ospf 2 area 0
Router(config-if)# exit
Router(config)# interface Loopback 100
Router(config-if)# vrf forwarding VRF_GREEN
Router(config-if)# ip address 60.1.1.1 255.255.255.0
Router(config-if)# ip ospf 2 area 0
Router(config-if)# exit
Router(config)# interface tunnel 10
Router(config-if)# vrf forwarding VRF_RED
Router(config-if)# ipv6 address 2001:A000:100::1/128
Router(config-if)# mls 6rd reserve interface GigabitEthernet4/5
Router(config-if)# tunnel source loopback 100
Router(config-if)# tunnel mode ipv6ip 6rd
Router(config-if)# tunnel 6rd ipv4 prefix-len 16 suffix-len 8
Router(config-if)# tunnel 6rd prefix 2001:A000::/32
Router(config-if)# tunnel 6rd br 60.1.2.1
Router(config-if)# tunnel vrf VRF_GREEN
Router(config-if)# exit
Router(config)# ipv6 route vrf VRF_RED 2001:A000::/32 Tunnel10
Router(config)# ipv6 route vrf VRF_RED 9000:1000::/64 Tunnel10 2001:A000:200::1
Router(config)# end

```

The following example shows how to configure the VRF-Aware IPv6 Rapid Deployment Tunnel on a BR router:

```

Router# enable
Router# configure terminal
Router(config)# ipv6 unicast-routing
Router(config)# vrf definition VRF_RED
Router(config-vrf)# rd 1:1
Router(config-vrf)# route-target export 1:1
Router(config-vrf)# route-target import 1:1
Router(config-vrf)# address-family ipv6
Router(config-vrf-af)# exit
Router(config-vrf)# address-family ipv4
Router(config-vrf-af)# exit
Router(config-vrf)# exit

```

```

Router(config)# vrf definition VRF_GREEN
Router(config-vrf)# rd 1:1
Router(config-vrf)# route-target export 1:1
Router(config-vrf)# route-target import 1:1
Router(config-vrf)# address-family ipv4
Router(config-vrf-af)# exit
Router(config-vrf)# exit
Router(config)# interface gigabitethernet 5/1
Router(config-if)# vrf forwarding VRF_RED
Router(config-if)# ipv6 address 9000:1000::/64
Router(config-if)# exit
Router(config)# interface gigabitethernet 4/1
Router(config-if)# vrf forwarding VRF_GREEN
Router(config-if)# ip address 17.1.1.2 255.255.255.0
Router(config-if)# ip ospf 2 area 0
Router(config-if)# exit
Router(config)# interface Loopback 100
Router(config-if)# vrf forwarding VRF_GREEN
Router(config-if)# ip address 60.1.2.1 255.255.255.0
Router(config-if)# exit
Router(config)# interface tunnel 10
Router(config-if)# vrf forwarding VRF_RED
Router(config-if)# ipv6 address 2001:A000:100::1/128
Router(config-if)# tunnel source loopback 100
Router(config-if)# tunnel mode ipv6ip 6rd
Router(config-if)# tunnel 6rd ipv4 prefix-len 16 suffix-len 8
Router(config-if)# tunnel 6rd prefix 2001:A000::/32
Router(config-if)# tunnel vrf VRF_GREEN
Router(config-if)# exit
Router(config)# ipv6 route vrf VRF_RED 2001:A000::/32 Tunnel10
Router(config)# end

```

Additional References

Related Documents

Related Topic	Document Title
IPv6 addressing and connectivity	IPv6 Configuration Guide
Cisco IOS commands	Cisco IOS Master Commands List, All Releases
IPv6 commands	Cisco IOS IPv6 Command Reference
Cisco IOS IPv6 features	Cisco IOS IPv6 Feature Mapping

Standards and RFCs

Standard/RFC	Title
RFCs for IPv6	IPv6 RFCs

Technical Assistance

Description	Link
The Cisco Support and Documentation website provides online resources to download documentation, software, and tools. Use these resources to install and configure the software and to troubleshoot and resolve technical issues with Cisco products and technologies. Access to most tools on the Cisco Support and Documentation website requires a Cisco.com user ID and password.	http://www.cisco.com/cisco/web/support/index.html

Feature Information for the VRF-Aware IPv6 Rapid Deployment Tunnel

The following table provides release information about the feature or features described in this module. This table lists only the software release that introduced support for a given feature in a given software release train. Unless noted otherwise, subsequent releases of that software release train also support that feature.

Use Cisco Feature Navigator to find information about platform support and Cisco software image support. An account on Cisco.com is not required.

Table 28: Feature Information for the VRF-Aware IPv6 Rapid Deployment Tunnel

Feature Name	Releases	Feature Information
VRF-Aware IPv6 Rapid Deployment Tunnel	Cisco IOS XE Release 3.10S	The IPv6 Rapid Deployment Tunnel feature allows a service provider to provide a unicast IPv6 service to customers over its IPv4 network by using encapsulation of IPv6 in IPv4. The VRF-Aware IPv6 Rapid Deployment Tunnel feature extends VRF awareness to IPv6 rapid deployment tunnels.



CHAPTER 23

IP Tunnel - GRE Key Entropy Support

The IP Tunnel - GRE Key Entropy Support feature enables load balancing of tunnel packets in the Generic Routing Encapsulation (GRE) mode of a core network.

- [Finding Feature Information, on page 229](#)
- [Prerequisites for IP Tunnel - GRE Key Entropy Support, on page 229](#)
- [Restrictions for IP Tunnel - GRE Key Entropy Support, on page 229](#)
- [Information About IP Tunnel - GRE Key Entropy Support, on page 230](#)
- [How To Configure IP Tunnel - GRE Key Entropy Support, on page 230](#)
- [Configuration Examples for IP Tunnel - GRE Key Entropy Support, on page 232](#)
- [Additional References for IP Tunnel - GRE Key Entropy Support, on page 233](#)
- [Feature Information for IP Tunnel - GRE Key Entropy Support, on page 234](#)

Finding Feature Information

Your software release may not support all the features documented in this module. For the latest caveats and feature information, see [Bug Search Tool](#) and the release notes for your platform and software release. To find information about the features documented in this module, and to see a list of the releases in which each feature is supported, see the feature information table.

Use Cisco Feature Navigator to find information about platform support and Cisco software image support. To access Cisco Feature Navigator, go to www.cisco.com/go/cfn. An account on Cisco.com is not required.

Prerequisites for IP Tunnel - GRE Key Entropy Support

- You can enable tunnel entropy calculation only on Generic Routing Encapsulation (GRE) mode of the tunnel interface.
- You must configure the tunnel key value before you enable tunnel entropy calculation.

Restrictions for IP Tunnel - GRE Key Entropy Support

- You must not configure a tunnel key with a value that is more than 24 bits. The configuration of tunnel entropy calculation fails if the tunnel key value is more than 24 bits.

- You cannot disable tunnel entropy calculation unless you remove the configured tunnel key.

Information About IP Tunnel - GRE Key Entropy Support

IP Tunnel - GRE Key Entropy Support Overview

The IP Tunnel - GRE Key Entropy Support feature enables load balancing of tunnel packets in the Generic Routing Encapsulation (GRE) mode of a core network. You can configure the tunnel entropy calculation feature only on the GRE mode of the tunnel interface.

The characteristics of a tunnel entropy label are:

- You cannot use entropy labels for packet forwarding.
- You cannot use entropy labels for signaling.
- You can only use the entropy label to improve load balancing on a network.

In order to configure tunnel entropy calculation using the **tunnel entropy** command, you must first configure a tunnel key using the **tunnel key** command in interface configuration mode. The tunnel key has a maximum size of 32 bits. If you configure tunnel entropy calculation, 24 bits are reserved for the GRE key and 8 bits for entropy.



Note

If you configure a GRE tunnel key of 32 bits, you cannot configure tunnel entropy calculation. You must remove the tunnel key and then configure a key of the size of 24 bits or less. To disable an already configured GRE tunnel entropy, remove the GRE tunnel key value first.

Entropy bits are calculated by 6 tuples, which are virtual routing and forwarding (VRF) ID, source IP address, destination IP address, source port, destination port, and protocols of the private IPv4/IPv6 packets in a network.

How To Configure IP Tunnel - GRE Key Entropy Support

Configuring IP Tunnel - GRE Key Entropy Support

Perform this task to configure GRE tunnel entropy calculation:

SUMMARY STEPS

1. **enable**
2. **configure terminal**
3. **interface tunnel** *tunnel-number*
4. **tunnel source** {*ipv4-addr* | *ipv6-addr* | *interface-type interface-number* | **dynamic**}
5. **tunnel destination** {*ipv4-addr* | *ipv6-addr* | *hostname* | **dynamic**}
6. **tunnel mode gre ip**
7. **tunnel key** *key-number*

8. **tunnel entropy**
9. **end**
10. **show interfaces** *interface-type interface-number*

DETAILED STEPS

	Command or Action	Purpose
Step 1	enable Example: <pre>Device> enable</pre>	Enables privileged EXEC mode. <ul style="list-style-type: none"> • Enter your password if prompted.
Step 2	configure terminal Example: <pre>Device# configure terminal</pre>	Enters global configuration mode.
Step 3	interface tunnel <i>tunnel-number</i> Example: <pre>Device(config)# interface tunnel 21</pre>	Specifies a tunnel interface and number, and enters interface configuration mode.
Step 4	tunnel source { <i>ipv4-addr</i> <i>ipv6-addr</i> <i>interface-type interface-number</i> dynamic } Example: <pre>Device(config-if)# tunnel source 10.1.1.1</pre>	Specifies the source IP address for a tunnel interface.
Step 5	tunnel destination { <i>ipv4-addr</i> <i>ipv6-addr</i> <i>hostname</i> dynamic } Example: <pre>Device(config-if)# tunnel destination 172.168.2.1</pre>	Specifies the destination IP address for a tunnel interface.
Step 6	tunnel mode gre ip Example: <pre>Device(config-if)# tunnel mode gre ip</pre>	Configures the encapsulation mode for a tunnel interface.
Step 7	tunnel key <i>key-number</i> Example: <pre>Device(config-if)# tunnel key 4683</pre>	Enables an ID key for a tunnel interface.
Step 8	tunnel entropy Example: <pre>Device(config-if)# tunnel entropy</pre>	Achieves load balancing of tunnel packets in a network.

	Command or Action	Purpose
Step 9	end Example: Device(config-if)# end	Returns to privileged EXEC mode.
Step 10	show interfaces <i>interface-type interface-number</i> Example: Device# show interfaces tunnel 21	Displays statistics for all interfaces configured on a device or access server.

Configuration Examples for IP Tunnel - GRE Key Entropy Support

Examples: Configuring IP Tunnel - GRE Key Entropy Support

The following example shows how to configure tunnel entropy calculation for GRE mode of the tunnel interface:

```
Device> enable
Device# configure terminal
Device(config)# interface tunnel 21
Device(config-if)# tunnel source 10.1.1.1
Device(config-if)# tunnel destination 172.168.2.1
Device(config-if)# tunnel mode gre ip
Device(config-if)# tunnel key 4683
Device(config-if)# tunnel entropy
Device(config-if)# end
```

The following is sample output from the **show interfaces tunnel** command, which displays that tunnel entropy calculation is enabled with a 24-bit key:

```
Device# show interfaces tunnel 21

Tunnel21 is up, line protocol is up
Hardware is Tunnel
MTU 17864 bytes, BW 100 Kbit/sec, DLY 50000 usec,
reliability 255/255, txload 1/255, rxload 1/255
Encapsulation TUNNEL, loopback not set
Keepalive not set
Tunnel source 10.1.1.1, destination 172.168.2.1
Tunnel protocol/transport GRE/IP
Key 0x124B, sequencing disabled
Checksumming of packets disabled
Tunnel Entropy Calculation Enabled (24-bit Key)
Tunnel TTL 255, Fast tunneling enabled
Tunnel transport MTU 1472 bytes
Tunnel transmit bandwidth 8000 (kbps)
Tunnel receive bandwidth 8000 (kbps)
Last input never, output never, output hang never
Last clearing of "show interface" counters 00:03:07
Input queue: 0/375/0/0 (size/max/drops/flushes); Total output drops: 0
Queueing strategy: fifo
```

```

Output queue: 0/0 (size/max)
5 minute input rate 0 bits/sec, 0 packets/sec
5 minute output rate 0 bits/sec, 0 packets/sec
0 packets input, 0 bytes, 0 no buffer
Received 0 broadcasts (0 IP multicasts)
0 runts, 0 giants, 0 throttles
0 input errors, 0 CRC, 0 frame, 0 overrun, 0 ignored, 0 abort
0 packets output, 0 bytes, 0 underruns
0 output errors, 0 collisions, 0 interface resets
0 unknown protocol drops
0 output buffer failures, 0 output buffers swapped out

```

Additional References for IP Tunnel - GRE Key Entropy Support

Related Documents

Related Topic	Document Title
Cisco IOS commands	<i>Cisco IOS Master Command List, All Releases</i>
Tunnel commands: complete command syntax, command mode, defaults, command history, usage guidelines, and examples	<i>Cisco IOS Interface and Hardware Component Command Reference</i>
Cisco IOS XE Interface and Hardware Component configuration modules	<i>Cisco IOS XE Interface and Hardware Component Configuration Guide</i>

Standards and RFCs

RFC	Title
RFC6790	The Use of Entropy Labels in MPLS Forwarding

Technical Assistance

Description	Link
<p>The Cisco Support website provides extensive online resources, including documentation and tools for troubleshooting and resolving technical issues with Cisco products and technologies.</p> <p>To receive security and technical information about your products, you can subscribe to various services, such as the Product Alert Tool (accessed from Field Notices), the Cisco Technical Services Newsletter, and Really Simple Syndication (RSS) Feeds.</p> <p>Access to most tools on the Cisco Support website requires a Cisco.com user ID and password.</p>	http://www.cisco.com/support

Feature Information for IP Tunnel - GRE Key Entropy Support

The following table provides release information about the feature or features described in this module. This table lists only the software release that introduced support for a given feature in a given software release train. Unless noted otherwise, subsequent releases of that software release train also support that feature.

Use Cisco Feature Navigator to find information about platform support and Cisco software image support. To access Cisco Feature Navigator, go to www.cisco.com/go/cfn. An account on Cisco.com is not required.

Table 29: Feature Information for IP Tunnel - GRE Key Entropy Support

Feature Name	Releases	Feature Information
IP Tunnel - GRE Key Entropy Support	Cisco IOS XE Release 3.11S	<p>The IP Tunnel - GRE Key Entropy Support feature enables load balancing of tunnel packets in the Generic Routing Encapsulation (GRE) mode of a core network.</p> <p>The following commands were introduced or modified:</p> <p>tunnel entropy</p> <p>tunnel key</p> <p>show interfaces</p>