



Cisco ACI Simulator VM Release Notes, Release 6.0(5)

Introduction

The Cisco Application Centric Infrastructure (ACI) is conceptualized as a distributed, scalable, multi-tenant infrastructure with external endpoint connectivity that is controlled and grouped through application centric policies. The Cisco Application Policy Infrastructure Controller (APIC) is the key architectural component that is the unified point of automation, management, monitoring, and programmability for the Cisco ACI. The Cisco APIC supports the deployment, management and monitoring of any application anywhere, with a unified operations model for physical and virtual components of the infrastructure. The Cisco APIC programmatically automates network provisioning and control based on the application requirements and policies. It is the central control engine for the broader cloud network, simplifying management while allowing tremendous flexibility in how application networks are defined and automated and also providing northbound REST APIs. The Cisco APIC is a distributed system implemented as a cluster of many controller instances.

This document provides the compatibility information, usage guidelines, and the scale values that were validated in testing this Cisco ACI Simulator VM release. Use this document in combination with the documents listed in the Related Documentation section.

The Cisco ACI Simulator VM 6.0(5) release contains the same functionality as the Cisco Application Policy Infrastructure Controller (APIC) 6.0(5) release. For information about the functionality, see the [Cisco Application Policy Infrastructure Controller Release Notes, Release 6.0\(5\)](#).

For more information about this product, see "Related Content."

Date	Description
February 28, 2024	Release 6.0(5h) became available.

Cisco ACI Simulator VM

The intent of the Cisco ACI Simulator VM is to provide real, fully-featured Cisco APIC software, along with a simulated fabric infrastructure of leaf switches and spine switches in one physical server. You can use the Cisco ACI Simulator VM to understand features, exercise APIs, and initiate integration with third-party orchestration systems and applications. The native GUI and CLI of the Cisco APIC use the same APIs that are published to third parties.

The Cisco ACI Simulator VM includes simulated switches, so you cannot validate a data path. However, some of the simulated switch ports have been mapped to the front-panel server ports, which allows you to connect external management entities such as ESX servers, vCenters, vShields, bare metal servers, Layer 4 to Layer 7 services, AAA systems, and other physical or virtual service VMs. In addition, the Cisco ACI Simulator VM allows simulation of faults and alerts to facilitate testing and demonstrate features.

One instance of the production Cisco APIC will be shipped per server VM. By contrast, the Cisco ACI Simulator VM includes three actual Cisco APIC instances and two simulated leaf switches and two simulated spine switches in a single server. As a result, the performance of the Cisco ACI Simulator VM will be slower than deployments on actual hardware. You can perform operations on the simulated fabric using any of the following functional interfaces:

- Graphical user interface (GUI)
- Command Line Interface (CLI)
- Application programming interface (API)

Figure 1 shows the components and connections simulated within the simulator server.

Figure 1 Simulated Components and Connections in the Cisco ACI Simulator VM Server

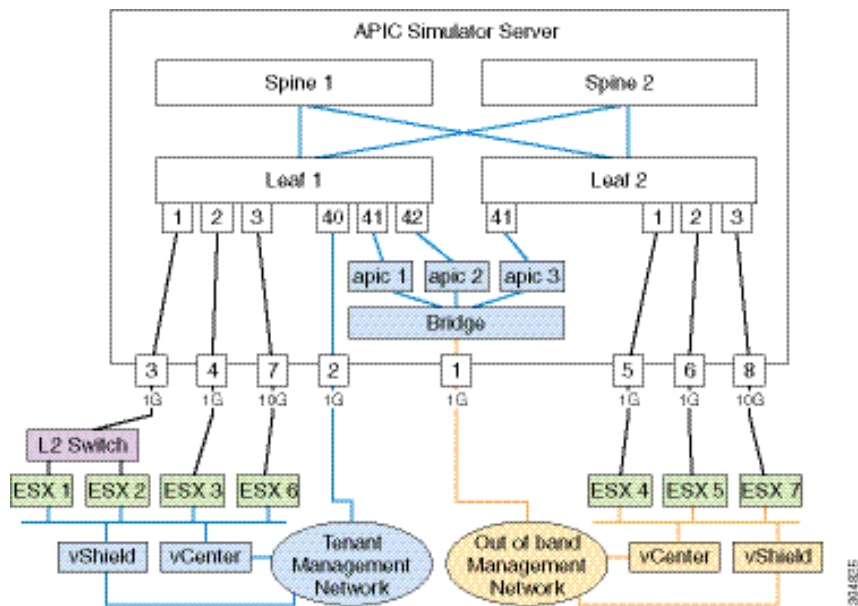

Software Features

This section lists the key software features of the Cisco ACI Simulator VM that are available in this release.

- Application centric network policies
- Data model-based declarative provisioning
- Application, topology monitoring, and troubleshooting
- Third-party integration (Layer 4 to Layer 7 services, WAN, vCenter, vShield)
- Physical infrastructure policies (spine and leaf)
- Cisco ACI inventory and configuration
- Implementation on a distributed framework across a cluster of appliances
- Health Scores for key Managed Objects (tenants, application profiles, switches, and so on)
- Fault, event and performance management

Installation Notes

The Cisco ACI Simulator software is preinstalled on the Cisco ACI Simulator VM. When you launch the Cisco ACI Simulator VM for the first time, the Cisco APIC console presents a series of initial setup options. See the [Cisco ACI Simulator VM Installation Guide](#) for information about the setup options.

The ISO image is not supported. You must use the OVA image.

Compatibility Information

This release of the Cisco ACI Simulator VM supports the following software:

-
- For the supported VMware vCenter and vShield releases, see the [ACI Virtualization Compatibility Matrix](#).
 - Web browsers for the Cisco ACI Simulator VM GUI:
 - Chrome version 35 (at minimum) on Mac and Windows.
 - Firefox version 26 (at minimum) on Mac and Windows.
 - The Cisco ACI Simulator VM does not support Smart Licensing.

General Usage Guidelines

Observe the following guidelines when using this software release:

- The Cisco ACI Simulator VM software cannot be installed separately on a standard Cisco UCS C220 Server or on other servers. The software runs only on the Cisco ACI Simulator VM server, which has the following PID:
 - APIC-SIM-S2 (based on Cisco UCS C220 M4 server)
- The Cisco ACI Simulator VM GUI includes an online version of the Quick Start guide that includes video demonstrations.
- Do not do change the following:
 - Default names in the initial setup for node names and the cluster configuration.
 - Cluster size and the number of Cisco APIC nodes.
 - Infra VLAN.
- The Cisco ACI Simulator VM does not support the following:
 - Configuration of a DHCP server policy.
 - Configuration of a DNS service policy.
 - Configuring out-of-band management access for switches.
 - Data path forwarding (the Cisco ACI Simulator VM includes simulated switches).
 - CDP is not supported between a leaf and an ESX/hypervisor or between a leaf and an unmanaged/L2 switch. Only LLDP is supported in these cases.
- The Cisco ACI Simulator VM uses NAT for inband management. Inband IPs configured by policy are not used. Instead, Cisco APIC and node inband IPs are internally allocated.
- Cisco APIC out-of-band management IP/Gateway cannot be modified using an out-of-band management policy and can be configured only during the Cisco APIC first time setup screen.
- Keep the vMotion PNIC outside of the Simulator network.
- The infrastructure EPG in the Infra tenant is for internal use only.
- The MP-BGP route reflector and the OSPF external routed network protocols do not work if you are using the simulator

- Virtual shell (VSH) and ishell commands do not work on switches. These commands are implemented on the Cisco NX-OS software, and the Cisco NX-OS software is not available on the simulator.
- The MP-BGP route reflector and the OSPF external routed network protocols do not work if you are using the simulator.
- Virtual shell (VSH) and ishell commands do not work on switches. These commands are implemented on the Cisco NX-OS software, and the Cisco NX-OS software is not available on the simulator.
- Statistics are simulated. As a result, threshold crossing alert (TCA) faults are generated in the simulator to demonstrate the fault generation on the statistics threshold crossing.
- Create a syslog and Call Home source policy under common policy. This policy applies at the system level and sends all syslog and Call Home messages system wide. The GUI path to create syslog and Call Home under common policy are as follows: Admin / External Data Collector/ Monitoring Destinations / [Callhome | SNMP | Syslog].
- The Cisco ACI Simulator VM simulates faults for counters, which might cause the health score of the top-of-rack (TOR) switch to go down. The faults look similar to the following example:

```
<faultInst ack="no" cause="threshold-crossed" changeSet="" childAction="" code="F54431"
created="2014-01-21T17:20:13.179+00:00" descr="TCA: l2IngrBytes5min dropRate value
9049.94 raised above threshold 9000 and value is recovering" dn="topology/pod-1/node-
17/sys/ctx-[vxlان-2621440]/bd-[vxlان-15826914]/vlan-[vlan- 1031]/fault-F54431"
domain="infra" highestSeverity="minor" lastTransition="2014-01-21T17:22:35.185+00:00"
lc="raised" modTs="never" occur="1" origSeverity="minor" prevSeverity="minor" rule="tca-l2-
ingr-bytes-drop-rate" severity="minor" status="" subject="counter" type="operational" />
<faultInst ack="no" cause="threshold-crossed" changeSet="" childAction="" code="F54447"
created="2014-01-21T17:20:13.244+00:00" descr="TCA: l2IngrPkts5min dropRate value
3.53333 raised above threshold 10" dn="topology/pod-1/node-17/sys/ctx-[vxlان-2621440]/bd-
[vxlان-15826914]/vlan-[vlan-1 031]/fault-F54447" domain="infra" highestSeverity="warning"
lastTransition="2014-01-21T19:42:37.983+00:00" lc="retaining" modTs="never" occur="9"
origSeverity="warning" prevSeverity="warning" rule="tca-l2-ingr-pkts-drop-rate"
severity="cleared" status="" subject="counter" type="operational" />
```

Layer 4 to Layer 7 Services Usage Guidelines

Observe the following guidelines when using Layer 4 to Layer 7 services:

- This release supports Layer 4 to Layer 7 services integration with Citrix and ASA. These packages are not prepackaged in the Simulator VM. Depending on the Layer 4 to Layer 7 services that you want to test, you should procure the corresponding package from the file share.
- Service nodes should be connected using the out-of-band connection. The service node and the Cisco APIC should be in the same subnet.
- You can test Layer 4 to Layer 7 services by connecting your service appliance using in-band management connectivity between the simulator and the appliance.

Supported Scale With the Cisco ACI Simulator VM

The following table lists the scale values that were tested without an external service node in this release.

Object	Value
Tenants	10
EPGs	100
Contracts	100
EPG per Tenant	10
Contracts per Tenant	20
vCenter	2
vShield	2

Related Content

See the [Cisco Application Centric Infrastructure Simulator](#) page for the Cisco ACI Simulator documentation.

See the [Cisco Cloud Application Policy Infrastructure Controller](#) page for the Cisco APIC documentation.

Documentation Feedback

To provide technical feedback on this document, or to report an error or omission, send your comments to apic-docfeedback@cisco.com. We appreciate your feedback.

Legal Information

Cisco and the Cisco logo are trademarks or registered trademarks of Cisco and/or its affiliates in the U.S. and other countries. To view a list of Cisco trademarks, go to this URL: <http://www.cisco.com/go/trademarks>. Third-party trademarks mentioned are the property of their respective owners. The use of the word partner does not imply a partnership relationship between Cisco and any other company. (1110R)

Any Internet Protocol (IP) addresses and phone numbers used in this document are not intended to be actual addresses and phone numbers. Any examples, command display output, network topology diagrams, and other figures included in the document are shown for illustrative purposes only. Any use of actual IP addresses or phone numbers in illustrative content is unintentional and coincidental.

© 2024 Cisco Systems, Inc. All rights reserved.