



Redundancy Configuration Manager Configuration and Administration Guide, Release 2024.02

First Published: 2024-04-30

Contents

Overview.....	7
Components.....	7
Minimum Requirements.....	8
Hardware Requirements.....	8
Software Requirements.....	8
Deploying the RCM.....	9
RCM VM Deployment Procedure.....	9
RCM Deployment Architecture.....	11
How it Works.....	12
Redundancy Management.....	12
Architecture.....	13
Upgrade Process.....	14
N:M Redundancy Architecture.....	14
UP Registration Call Flow.....	15
Operational Flow.....	15
Switchover and Recovery.....	17
Configuration Management.....	22
Performing Planned Switchover.....	24
Deferring SSH IP Installation.....	24
Redesigning Configuration Manager to Support Large Common Configurations.....	24
How it Works.....	25
Limitations and Restrictions.....	26
Preventing Dual Active Error Scenarios.....	27
Preventing Successive Switchover Due to Sx Monitor Failure.....	27
Example Ops Center Host-specific Configuration.....	27
Configuring the RCM.....	28
Configuring the Controller Pod.....	28
Configuring the BFD Manager Pod.....	29
Configuring the ConfigMgr Pod.....	29
Configuring UP Credentials.....	30
Restricting Configuration Maps Pushed to Configuration Manager.....	31
Configuring the Redundancy Manager Pod.....	32
Configuring Init Wait Timeout and Mass UPF Failure Timeout.....	33
Configuring UP with Day-0 Configuration.....	33
Configuring Planned Switchover Timers.....	35
Configuring Failover Time Optimization for Unplanned Switchover.....	36
Configuring Local Time Zone.....	36

Overview

IP Pool Audit Configuration.....	37
Triggering IP Pool Audit Message	37
Configuring IP Pool Audit Timer	37
Prompting Wrong Route Modifiers.....	37
Configuring LZ4 Compression Algorithm	38
Changing RCM State from Pending-Active to Active.....	39
RCM Configuration to Enable NSO as Configurator	39
Preventing Multiple Configuration Push Notifications	40
Sample Configuration	40
Monitoring and Troubleshooting RCM	49
Show Commands and/or Outputs	49
SNMP Traps.....	50
Controller Pod.....	50
Configuration Manager Pod.....	50
Checkpoint Manager Pod.....	50
Keepalived Pod	51
strongSwan Manager Pod.....	51
Configuring SNMP Traps	51
Sample SNMP Trap	53
RCM High Availability.....	54
Feature Description	54
Architecture	54
How it Works	55
Keepalived	55
RCM Upgrade and Downgrade Procedure in HA	57
RCM Pause Switchover Command per Redundancy Group.....	57
Prerequisites and Assumptions.....	58
Operational Flow	58
Limitations	60
Configuring Ops Center for Keepalived Pod.....	60
Enabling Standalone RCM without Keepalived.....	61
Setting IPTables Rules for Keepalived.....	62
RCM IPSec.....	63
Feature Description	63
Architecture	63
Supported Algorithms.....	63
How it Works	64
RCM IPSec Tunnel Establishment.....	65

Overview

Checkpoint Data Transfer	66
RCM IPSec during Switchover	67
Limitations and Restrictions.....	67
Configuring RCM IPSec.....	67
Enabling IPSec in RCM.....	67
Disabling IPSec in RCM.....	67
Configuring IPSec Transform Set.....	68
Configuring IPSec Parameters.....	68
Configuring strongSwan Endpoint	69
Sample Configuration	69
SNMP Traps.....	70
Appendix A: Deployment Parameters	70
Typical Deployment	70
Parameters	71
Memory Sizing	71
CPU Sizing	71
Network Sizing	72
Hard Disk Sizing.....	72
Appendix B: Sample Common and Host-specific Configurations.....	73
Common Configuration	73
Host-specific Configuration.....	74
Appendix C: N:M Configuration Separation Table	78
Appendix D: Metrics	79
RCM Bfdmgr Controller Event Stats Category.....	79
bfdmgr_controller_event_stats.....	79
RCM Bfdmgr UPF Event Stats Category	79
bfdmgr_upf_event_stats	79
RCM checkpointmgr Current Emergency call count Category.....	80
chkptmgr_emergency_call_count	80
RCM checkpointmgr Current active VOLTE call count Category.....	80
chkptmgr_volte_active_call_count.....	80
RCM checkpointmgr Current call count Category.....	80
chkptmgr_total_call_count.....	80
RCM checkpointmgr Current non-active VOLTE call count Category.....	81
chkptmgr_volte_non_active_call_count	81
RCMcheckpointmgrCurrentnon-prioactivecallcountCategory.....	81
chkptmgr_non_prio_active_call_count	81
RCM checkpointmgr Current non-prio non-active call count Category	82

Overview

chkptmgr_non_prio_non_active_call_count	82
RCM checkpointmgr UP Audit count Category	82
chkptmgr_up_audit_count	82
RCM checkpointmgr UP Flush completed count Category	83
chkptmgr_up_flush_completed_count	83
RCM checkpointmgr UP connection count Category	83
chkptmgr_up_connection_count	83
RCM configmgr UP count Category	84
configmgr_upf_count	84
RCM configmgr config push complete count Category	84
configmgr_cfg_push_complete_count	84
RCM configmgr config push failure count Category	84
configmgr_cfg_push_failure_count	84
RCM configmgr switchover abort count Category	85
configmgr_swover_abort_count	85
RCM configmgr switchover failure count Category	85
configmgr_swover_failure_count	85
RCM controller BFD heartbeat failure count Category	85
controller_bfd_hb_timeout_stats	85
RCM controller IPC received count Category	86
controller_ipc_rcvd_stats	86
RCM controller IPC sent count Category	86
controller_ipc_sent_stats	86
RCM controller IPC sent error count Category	86
controller_ipc_sent_error_stats	86
RCM controller UPF BFD event count Category	87
controller_upf_bfd_event_stats	87
RCM controller UPF TCP connect count Category	87
controller_upf_tcp_connect_stats	87
RCM controller UPF TCP disconnect count Category	88
controller_upf_tcp_disconnect_stats	88
RCM controller UPF boot timer expiry count Category	88
controller_upf_boot_timer_expiry_stats	88
RCM controller UPF msg received count Category	88
controller_upf_msg_rcvd_stats	88
RCM controller UPF msg sent count Category	89
controller_upf_msg_sent_stats	89
RCM controller UPF registered count Category	89

Overview

controller_upf_registered_stats	89
RCM controller last switchover duration Category	90
controller_last_switchover_seconds_total	90
RCM controller mass UPF failure count Category	90
controller_mass_upf_failure_stats	90
RCM controller switchover count Category	90
controller_switchover_stats	90
RCM controller switchover failure count Category	91
controller_switchover_failure_stats	91
Example Expressions	91
Appendix E: MIBs	93
Appendix F: P2P/ADC Plugin Configuration and Update Procedure	103
Appendix G: RCM Configuration Generation Utility	104
Host Configurations	104
Script Help-string	106
Applying both Common and Host-specific Configuration	106
Applying Common Configuration	106
Applying Host-specific Configuration	107
Modifying Common Configuration	107
Modifying Host Configuration	107
Appendix H: RCM Deployment Known Issues	109

Overview

NOTE: The documentation set for this product strives to use bias-free language. For purposes of this documentation set, bias-free is defined as language that does not imply discrimination based on age, disability, gender, racial identity, ethnic identity, sexual orientation, socioeconomic status, and intersectionality. Exceptions may be present in the documentation due to language that is hardcoded in the user interfaces of the product software, language used based on RFP documentation, or language that is used by a referenced third-party product.

The Redundancy Configuration Manager (RCM) is a Cisco proprietary node/network function (NF) that provides redundancy of StarOS-based UPs. The RCM provides N:M redundancy of UPs wherein “N” is number of Active UPs and is less than 10, and “M” is number of Standby UPs in the redundancy group.

The RCM is developed using the Subscriber Microservices Infrastructure (SMI), a Cloud Native (CN) application. The RCM is delivered both as VM-based and CN-based image. For 4G, the RCM VM image is collocated with the UPs and deployed as a VM. For 5G, the RCM is deployed as CN application using the SMI Cluster Manager (SMI CM).

The RCM supports the following functions:

- **Redundancy Management**
 - Monitors the health of each Active UP
 - Selects a Standby UP to become Active when an Active UP becomes unreachable
 - Store session checkpoint information from Active UPs
 - Send session checkpoints to new Active UP during switchover
- **Configuration Management**
 - Decides the role of a UP; Active or Standby
 - Stores the configuration data that is sent to a UP
 - Provides the configuration data to a new UP (includes Day-0 to Day-N):
 - **Day-0:** Configuration required on UP with local context, management IP, and other static configurations other than ECS, APN and host-specific configurations (for example, bulkstats, thresholds, and so on.)
 - **Day-0.5 (RCM Context configurations):** Configuration required to connect to UP.

Note: Day-0 and Day-0.5 configuration is outside the scope of RCM and must be configured in UP using ESC/CM/NSO/CFP. Contact your Cisco Account representative for more details.

 - Determines the Control Planes (CPs) that register to the UPs

Components

The following diagram illustrates the components of RCM.

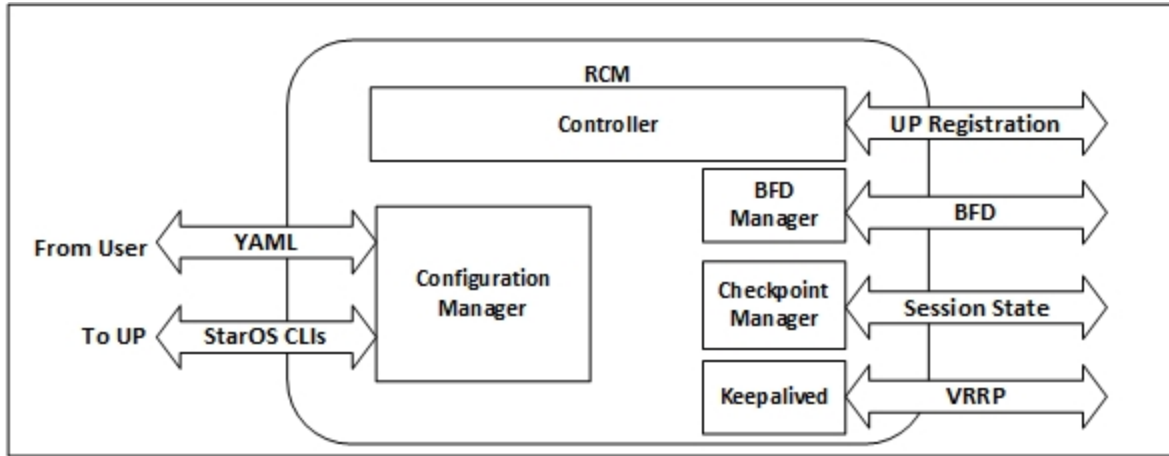

The RCM comprises of the following components which runs as pods in the RCM VM:

- **Controller:** It communicates event-specific decisions with all the other pods in RCM.
- **BFD Manager (BFDMgr):** It uses the BFD protocol to identify the state of data plane.
- **Configuration Manager (ConfigMgr):** It loads the requested configuration to the UPs.
- **Redundancy Manager (RedMgr):** It is also called the Checkpoint Manager; it stores and sends the checkpoint data to a standby UP.
- **Keepalived:** It communicates between Active and Standby RCM using VRRP.

Minimum Requirements

It is recommended that the RCM, which runs as a Kubernetes cluster on a VM, meets the minimum hardware and software requirements provided in the following tables.

For sizing parameters and recommendations for typical deployment setup, see [Appendix A: Deployment Parameters](#).

Hardware Requirements

Node Type	CPU Cores	RAM	Storage
RCM	(2 + No. of SessMgrs in one UP) x 2.60 GHz	8GB + 4GB for each Active UP	40GB HDD

Software Requirements

VIM	RCM Component Operating System
VMware - ESXI 5.5 or later	Ubuntu 18.04
OpenStack 13 or later	

NOTE: The above VM recommendation is validated for a single User Plane group of 12 (10:2) UPs.

Deploying the RCM

For 4G CUPS deployments, the RCM is deployed as VNF in a single VM. The following VM image types are available for deployment.

Image	Description
rcm-vm-airgap.<release>.ova.SPA.tgz	The RCM software image that is used to on-board the software directly into VMware.
rcm-vm-airgap.<release>.qcow2.SPA.tgz	The RCM software image in a format that can be loaded directly with KVM using an XML definition file, or with OpenStack.
rcm-vm-airgap.<release>.vmdk.SPA.tgz	The RCM virtual machine disk image software for use with VMware deployments.

To deploy the RCM:

1. Download the RCM image tar file that corresponds to your VIM type.
2. Unpack the RCM image from the tarfile related to your VIM.
3. Onboard the RCM image into your VIM per the instructions for your VIM.
4. Create a VM flavor based on the information in [Hardware Requirements](#) section.
5. Create cloud-init configuration per your VIM requirements. See [RCM VM Deployment Procedure](#) section.
6. Deploy the RCM image to the compute per the instructions for your VIM.
7. Proceed to “Configuring the RCM”.

RCM VM Deployment Procedure

The following steps describes the procedure to deploy the RCM VM:

1. Initialize the RCM VM instance using the cloud-init file.

Following is a sample configuration from cloud-init file (user_data.yaml):

```
#cloud-config
users:
  - default
  # password generated via: mkpasswd --method=SHA-512 --rounds=4096
  - name: luser
    gecos: luser
    primary_group: luser
    groups: [admin, adm, audio, cdrom, dialout, docker, floppy, luser,
video, plugdev, dip, netdev]
    lock_passwd: false
```

Overview

```

passwd:
$6$rounds=4096$Zl7FnVp7dYlT0bw$CFqAVNA8MlwxEXwAVYlKfekSrTXbGUnelihJ11xdNk
29bfCk2AURQG4XV.LnFNX6MmsW9OPvFxDZpeapXkYG.

shell: /bin/bash
home: /home/luser

ntp:
servers:
- 10.84.96.130
- 10.84.98.2
- 10.81.254.131

manage_etc_hosts: localhost

ssh_pwauth: yes

```

2. Create the cloud-locald rcm-seed image from the user_data file using the following command. The command can be executed from any local server or a jump server from where the deployment is carried out:

```
cloud-localds -H rcm rcm-seed.img user_data.yaml
```

Where:

- o **cloud-localds**: Creates a disk for cloud-init to utilize nocloud.
- o **-H**: Specifies the host name.

Usage/Syntax:

```
cloud-localds [ options ] output user-data [ meta-data ]
```

3. Attach the rcm-seed.img as CDROM to the VM.
4. After the VM is up:
 - a. Ensure the hostname of RCM VM is added to */etc/hosts*
For example: **127.0.1.1 rcm rcm**
Where *rcm* is the hostname.
 - b. Ensure that the kubeadm_init, kubelet, calico_init, chartmuseum, and init_cluster services are running. You can verify by executing the following command:

```
systemctl status kubelet/chartmuseum/init_cluster/calico_init
```

Note: Allow additional time (approximately 15 minutes) for Ops Center to come up on first boot. The extra time is required for the system startup to run certain hardening scripts that makes the system more secure.

Note: The helm version has been upgraded from 2 to 3.

You can check the following system service status. Excluding kubelet and chartmuseum, for which the status will display as Active (Running), status for all other services will display as Active (Exited):

- o **systemctl status kubelet**
- o **systemctl status kubeadm_init**
- o **systemctl status calico_init**

Overview

- **systemctl status hardening**
- **systemctl status chartmuseum**
- **systemctl status init_cluster**

The Ops Center pods comes up after the status of all the services are Active.

- c. For kubectl commands to work for a non-root user, please execute the following (this example assumes the user is called "luser"):

```
mkdir ~luser/.kube
sudo cp /etc/kubernetes/admin.conf ~luser/.kube/config
sudo chown luser:luser ~luser/.kube/config
```

- d. RCM ops-center pods can be seen in the RCM namespace:

```
kubectl get pods -n rcm
```

- e. Configure the UP username and password, in Ops Center, that are passed to ConfigMgr. For details, see [Configuring UP Credentials](#) section.

Note: Without configuring the UP credentials, ConfigMgr pod will not be in running state.

5. Configure the Ops Center to bring up the RCM component pods:

- a. Get ops-center pod name by executing below command

```
kubectl get pods -n rcm_namespace | grep ops-center
```

- b. Reset the password of the Ops Center using the following command:

```
kubectl exec -ti ops_center_pod reset-admin -n rcm
```

For example: `kubectl exec -ti ops-center-rcm-ops-center-d6d9cf976-jmght reset-admin -n rcm`

- c. Access the Ops Center using the password created in Step 5b.

- d. Access the Ops Center CLI using ops-center service IP:

```
kubectl get svc -n rcm
ssh -p 2024 admin@svc_ip
```

For example: `ops-center-rcm-ops-center ClusterIP 10.43.213.124<none> 8008/TCP,8080/TCP,2024/TCP,2022/TCP,7681/TCP 39h`

6. After Ops Center CLI is configured, run RCM components using the following command in Global Configuration mode:

```
system mode running
```

To remove RCM components: **system mode shutdown**

RCM Deployment Architecture

The following diagram illustrates a typical RCM deployment model.

How it Works

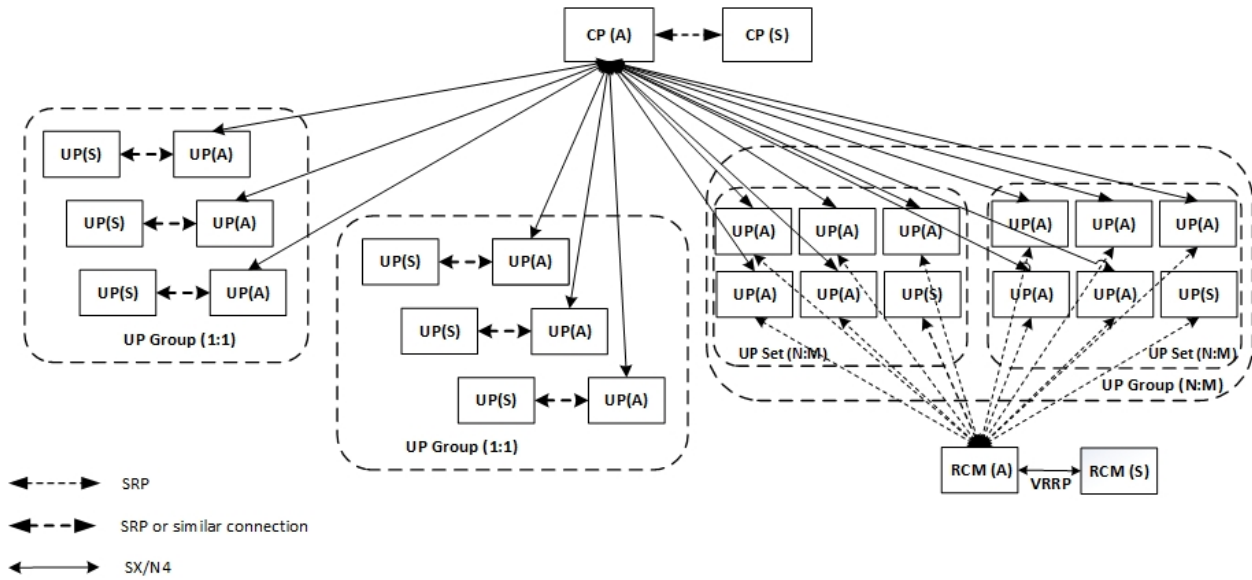

- It is co-located with all the UPs it manages; RCM can manage multiple independent UP groups.
Note that the UP groups in 1:1 redundancy mode is through ICSR and are not controlled by RCM.
- It has a high-performance network between itself and its UPs (SR-IOV or equivalent). Same is the case with Keepalive (VRRP) network between RCM HA instances.
- It monitors its UPs for failures and initiates failover to a standby UP.
- It quickly detects a UP failure using the multi-hop BFD protocol.
- It pre-configures (excluding CP and UPs Day-0 and Day-0.5 configuration as they are part of RCM) standby UPs with all the active host-specific configuration.
- Its user interface (UI) displays the state or health of a UP, stats, historical events (logs), and triggers a manual failover. In addition to monitoring, the UI supports the addition and removal of UPs and/or UP groups.
- If an RCM is configured without a redundant RCM, then the UPs under its control continue to run and provide services (not redundantly).
- If RCM restarts and connects to UPs, then the RCM re-learns or audit state from the existing UPs without disrupting services.

How it Works

This section describes how the RCM functions work:

- Redundancy Management
- Configuration Management

Redundancy Management

N:M redundancy using Redundancy and Configuration Manager (RCM), where $N > 1$ and M is at least 1, is a mechanism that is required to store all the required information at a common location. This common information is properly segregated based on “N” User Planes (UPs), and each UP contains “x” Session Managers (SessMgrs). On a switchover trigger, one of the “M” UPs

available as standby is selected to receive the appropriate data from the common location. This functionality is achieved through RCM.

To support N:M UP redundancy, the RCM provides the following functionality:

- Procedure to acquire the dynamic configuration based on the configuration changes. The Configuration Manager performs this procedure and pushes the configuration according to the state of the UP (Active or Standby).
- Method to store and retrieve the checkpoint data. It stores the checkpoint data because the exact standby for each Active UP is not pre-allocated. When an Active UP fail, the Redundancy Manager (RedMgr) pods send the stored checkpoint data to the newly selected UP from the available pool of standby UPs.
- Mechanism to detect the failure of a UP. A Bidirectional Forwarding Detection (BFD) Manager (BFDMgr) pod monitors the UP/UPFs and detects failures.
- Enables the RCM Controller pod to take decisions and instruct the other pods depending on the UP discovery or failure. Based on number of events, the Controller also controls the actions of the three managers: Configuration Manager, Redundancy Manager, and BFD Manager.
- Maintain information about the IP pool.

Architecture

The following diagram illustrates the logical network layout for a single VM RCM.

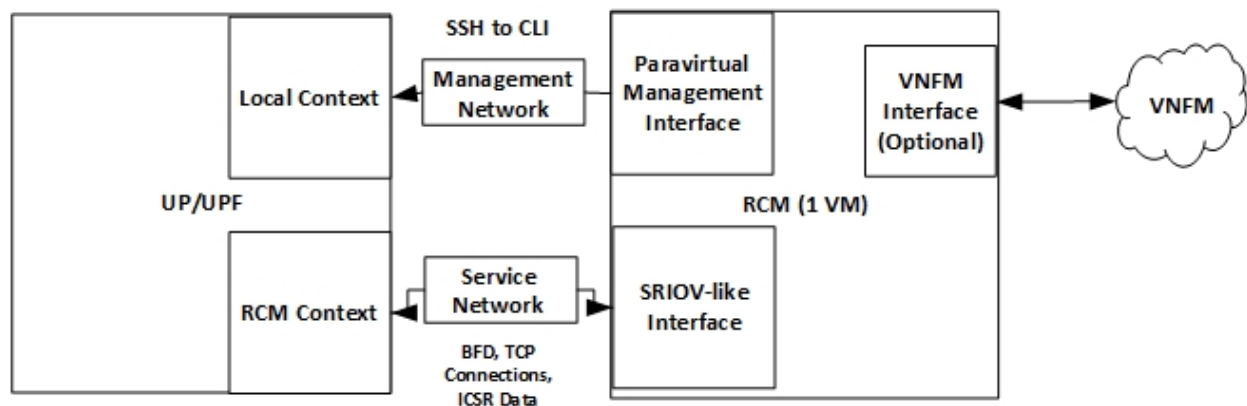

The RCM node is built on Subscriber Management Infrastructure (SMI). SMI provides the Kubernetes (K8s) infrastructure, which is used to bring all the required pods to support the redundancy for UPs.

The Ubuntu cloud image supports cloud-init based configuration (<https://cloud-init.io>). You must use cloud-init to configure local user accounts (ssh key or password-based) and network configuration.

RCM services (ConfigMgr, RedMgr, and so on) helm charts are prepopulated in the disk image. An RCM-specific Ops Center provides the user interface to RCM. On bootup, the Ops Center starts. After Ops Center configuration, other RCM services comes up.

In RCM, the VM requires multiple network interfaces. One interface for "management" connectivity (Ubuntu SSH daemon and Ops Center access), and another interface is for "service" connectivity (session state over this interface). The "management" interface has low throughput requirement and so, paravirtual NICs can be used. The "service" interface needs to be high speed and so, a SRIOV type interface is required. One optional "VNFM" interface can be used as pingable interface for ESC. Cloud-init is used to configure these NICs. Cloud-init configuration and NIC naming can vary depending on the environment.

For deployment information, refer [RCM Deployment](#) section.

Upgrade Process

Rolling upgrade of components is currently not supported in the VM-based application. Any updates to Ubuntu packages or RCM components are delivered through a new disk image. You must delete the current RCM instance, spawn a new RCM instance based on the new disk image, and then configure the new instance.

For upgrade/downgrade of RCM in HA, see [RCM Upgrade and Downgrade Procedure in HA](#).

N:M Redundancy Architecture

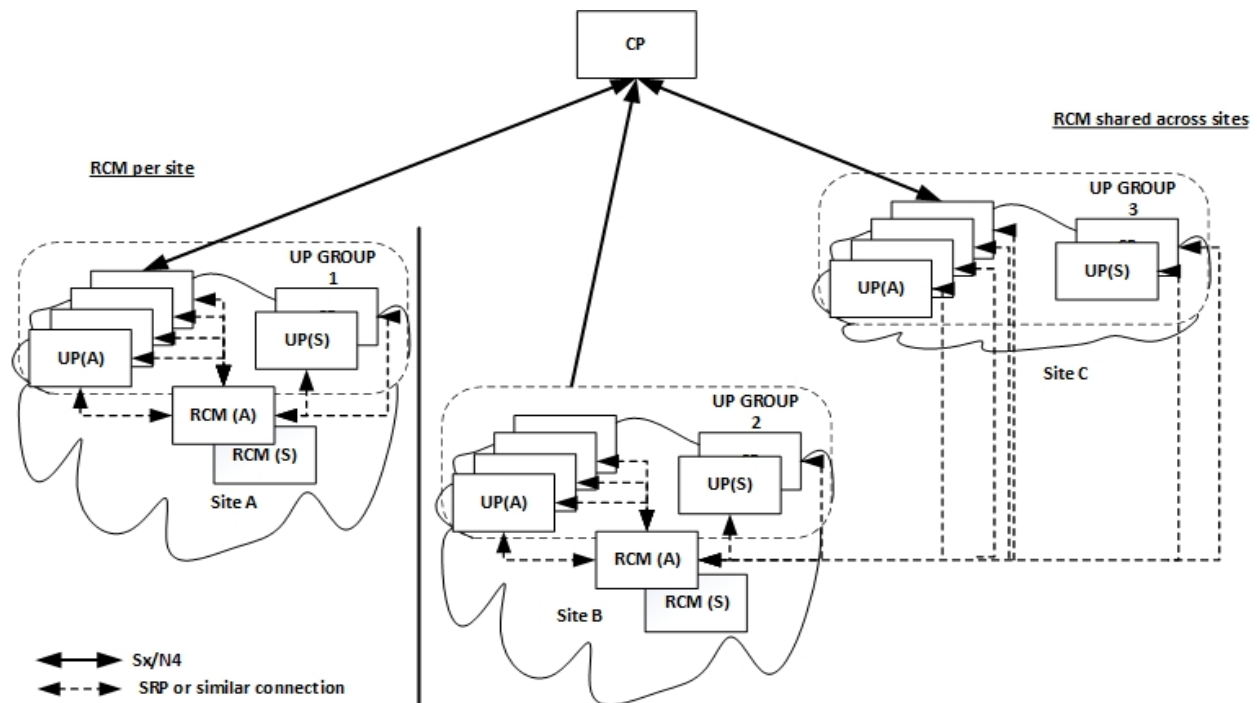

In 4G networks, UPs and CPs communicate over the Sx interface. In 5G, they communicate over N4 interface. The UP is user plane which could be a PGW-U, SGW-U, SAEGW-U, or UP(F). A group of UPs that are deployed to support the same configuration are said to be a part of same UP group (UPG). Therefore, for an N:M redundancy configuration, the UP group is comprised of (N+M) UPs that are of the same capacity and capability.

The UP transfers the checkpoint data to Redundancy Manager pods on the RCM. These pods receive the checkpoint data, store them, and segregate them properly so that each checkpoint is retrieved or modified properly. The checkpoint data reuses the same mechanism of Service Redundancy Protocol (SRP) on the UP to transfer the data to achieve the redundancy.

During switchover, the RCM Controller indicates to all the Redundancy Manager pods to push the data of the failed UP to a new UP. First, the Controller pushes the pool-chunk information to the newly selected UP. Secondly, the call records for all the subscribers are pushed to the corresponding Session Managers. Lastly, the Controller itself pushes the route modifier and IP pool information to the new UP. On receiving all the required data, the new UP becomes Active and services new calls along with the existing calls.

To ensure faster data retrieval, it is stored in memory. The checkpoint data that the Redundancy Manager receives is stored in the RAM. After careful segregation based on UP, session, and call, the checkpoint data is pushed to the new Active UP after a switchover from the RAM.

The BFD Manager detects the failure of a UP and informs the controller about the failure. Then, the Controller selects a new UP from the available pool of “m” standby. The Controller also instructs all the Redundancy Managers to transfer the checkpoint data to the new Active UP. It also handles the synchronization of data from various Redundancy Managers to the new UP.

The RCM supports multiple UP groups and segregates based on the UP group. If there is any failure notification, the Controller also identifies the UP. The Session Manager of the UP connects and stores the checkpoint data in the same Redundancy Manager pod. To achieve this result, the Redundancy Manager pod maintains the same IP and port even after a pod reboot.

UP Registration Call Flow

The following call flow illustrates the registration of UP.

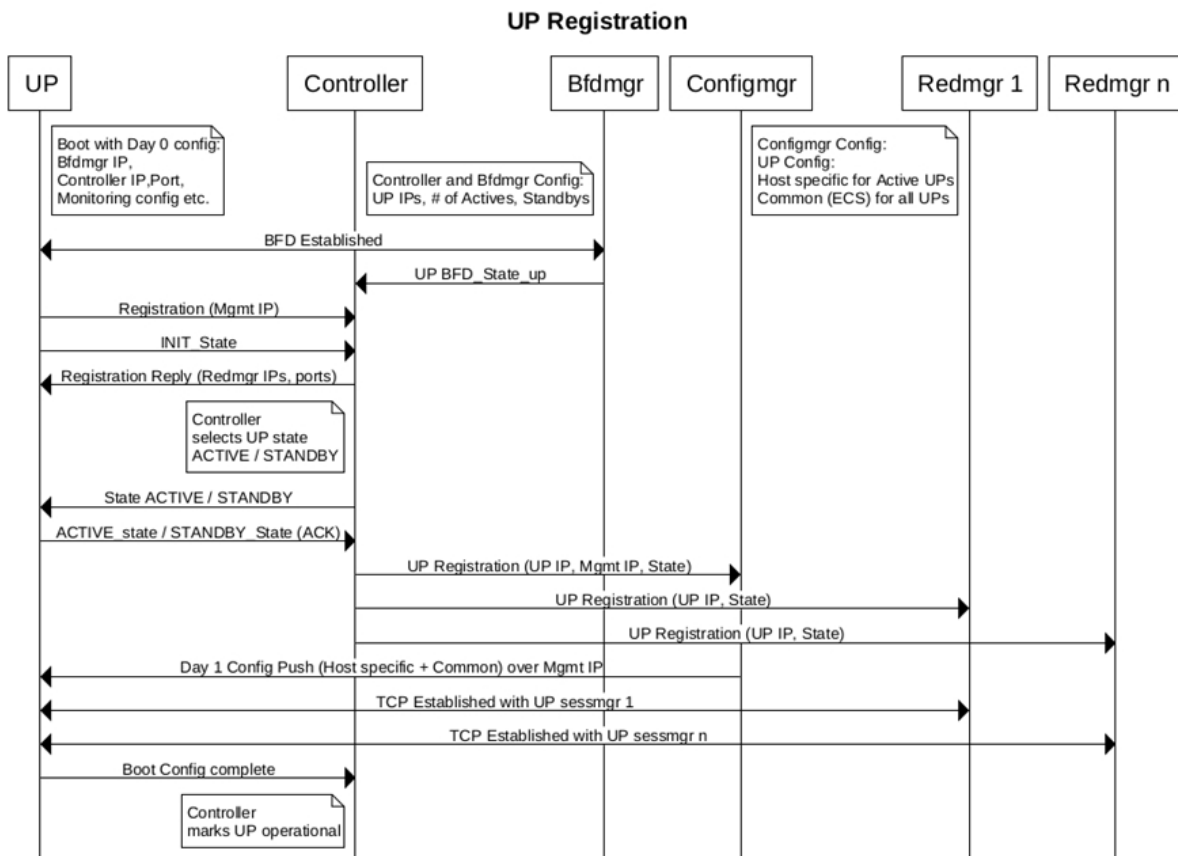

Operational Flow

Boot-up Sequence of Pods

On configuring redundancy, the Subscriber Microservices Infrastructure (SMI) brings up the following pods (not in any particular order):

- Configuration Manager Pod

How it Works

- **Redundancy Manager Pods:** These are a set of Redundancy Managers based on the UP group and number of Sessions Managers tasks that need support. Ideally this indicates the number of Session Managers tasks in each UP.
- **BFD Manager Pod:** This is a UP/UPF monitoring pod that monitors all the available UP/UPFs in a redundancy group.
- **Controller Pod:** This pod also comes up about the same time as all other pods.

Meanwhile, each UP comes up independently. Only the endpoint address of the RCM is configured for each UP.

When each pod comes up, the Controller is notified about the existence of each pod. The Configuration Manager indicates to the Controller about its presence. The Configuration Manager also indicates the readiness to push the configuration, on UP registration. When the Redundancy Manager pods come up, their presence is notified to the Controller. The Controller establishes a communication mechanism with all the Redundancy Manager pods. After the UP starts sending the checkpoint information to each Redundancy Manager, it updates the Controller about the hosting of the checkpoint data and the Session Manager instance. The BFD Manager also establishes the connection with the Controller and exchanges a handshake with the Controller.

RCM supports the following timers:

- **Init Wait timer:** The Init Wait timer defers the registration of Init state UPs and registers the active UPs first. This timer starts only when RCM controller starts or when RCM moves to HA MASTER state.

When RCM controller starts or moves to HA MASTER state, the RCM controller has no UPF state and learns the UP state from the UPs itself. The Init state UPFs should not be assigned HostIDs that are already allocated to Active UPs.
- **Mass UPF Failure timer:** The Mass UPF Failure timer starts when all UPs lose BFD connectivity with RCM. Depending on the network deployment, there can be network connectivity issue between RCM and UPs. If RCM cannot establish BFD connectivity to any UPF within the timeout period, then RCM HA switchover is performed.

UP Bootup Sequence

The following is the UP bootup sequence when the RCM is used:

1. The UP sends Init state to the RCM Controller.
2. The RCM Controller determines to make it Active or Standby and sets the state as PendActive or PendStandby in its data structures (The PendStandby is not available for switchover selection).
3. The RCM Controller sends State (Active or Standby), Host ID (Host string), and Route Modifier to the UP.
4. The UP responds to the RCM Controller acknowledging the State and Host ID.
5. The UP stores or updates its State and Host ID in Shared/System Configuration Task (SCT).

SCT is a StarOS task for configuring system parameters, retrieving information, and notifying system components of configuration changes.
6. The RCM Controller sends the UP's Endpoint, State, and Host ID notification to its Configuration Manager service.
7. The RCM Controller also sends the UP's Endpoint and State to its Redundancy Manager service.
8. The RCM Configuration Manager pushes the Active or Standby configuration to the UP.
9. The UP stores the "Config Pushed" flag in its SCT (vpnmgr) subsystem.
10. The UP sends a "Config Push Complete" notification to the RCM Controller through vpnmgr.
11. The RCM Controller marks PendActive or PendStandby as full Active or Standby. (The Standby state is now available for switchover).
12. The RCM Controller sends the "Config Push Complete" message its Configuration Manager service for reconfirmation.

UP Switchover Sequence

The following is the UP switchover sequence when the RCM is used:

1. The RCM Controller detects the failure of the UP.
2. The RCM Controller changes the mapping of UPs Endpoint to Host ID. And, assigns the failed Active UPs Host ID to a new Active UP that was selected from the Standby list.
3. The RCM Controller notifies its Configuration Manager service about switchover notification.
4. The RCM Configuration Manager activates the host-config of old Active (by negating others) and changes the mapping of Host ID to new Active UP.
5. The RCM Controller pushes the IP pool checkpoints to the new Active UP.
6. The RCM Controller notifies the Redundancy Manager service to push all the checkpoint data.
7. The RCM Controller sends State (Active) and Host ID to new Active UP.
8. The new Active UP receives the negate of config and control group association.
9. The new Active UP notifies the RCM Controller about the “Config Push Complete”.
10. The RCM Controller receives the “Config Pushed” flag from new Active and updates its data with State, Host ID, and pushed flag.
11. The RCM Controller notifies the Configuration Manager service about the “Config Push Complete” for validation.

RCM Controller Restart

Upon RCM Controller restart, the UP will detect connection failure and they will reattempt. Once RCM Controller is back, the UP will reconnect. The UPs that are in new state may have to wait for five minutes before successful registration.

VPNMgr Restart

Upon restart of the UP's VPNMgr, the VPNMgr reconnects with RCM Controller and ensures that both are in sync.

Switchover and Recovery

Planned Switchover

Planned switchovers can be done in the following ways:

- When a UP is manually rebooted/reloaded during a maintenance window wherein the UP indicates to the RCM about the event of going down.
- When switchover is triggered from the RCM by either the Controller, Configmgr, or BFDMgr using the CLI. For information about the CLI command, refer the [Performing Planned Switchover](#) section.

UPF supports the following switchover timers that are configurable using CLI. See the Configuring Planned Switchover Timers section for configuration details.

- Timer for planned switchover completion on new Active (Standby) UPF
- Timer for receipt of Standby state from the start of pending Standby state on old Active UPF

The following images illustrate the call flows for planned switchover.

How it Works

Planned Switchover

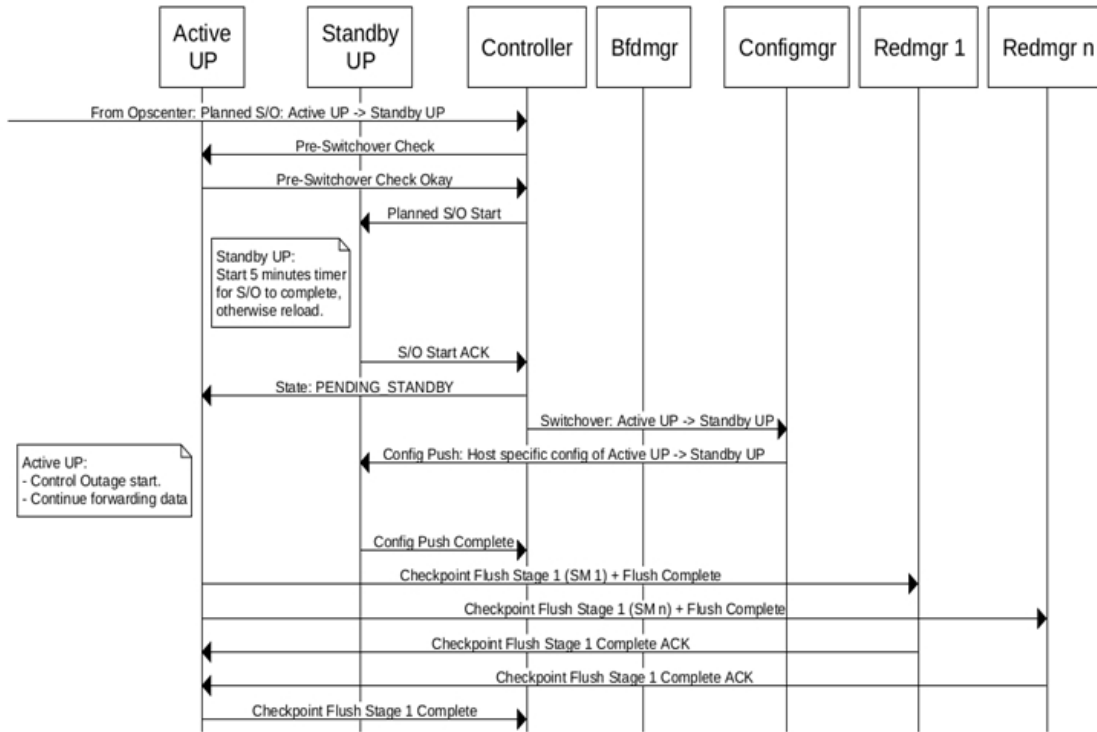

Planned Switchover (continued 2 of 3)

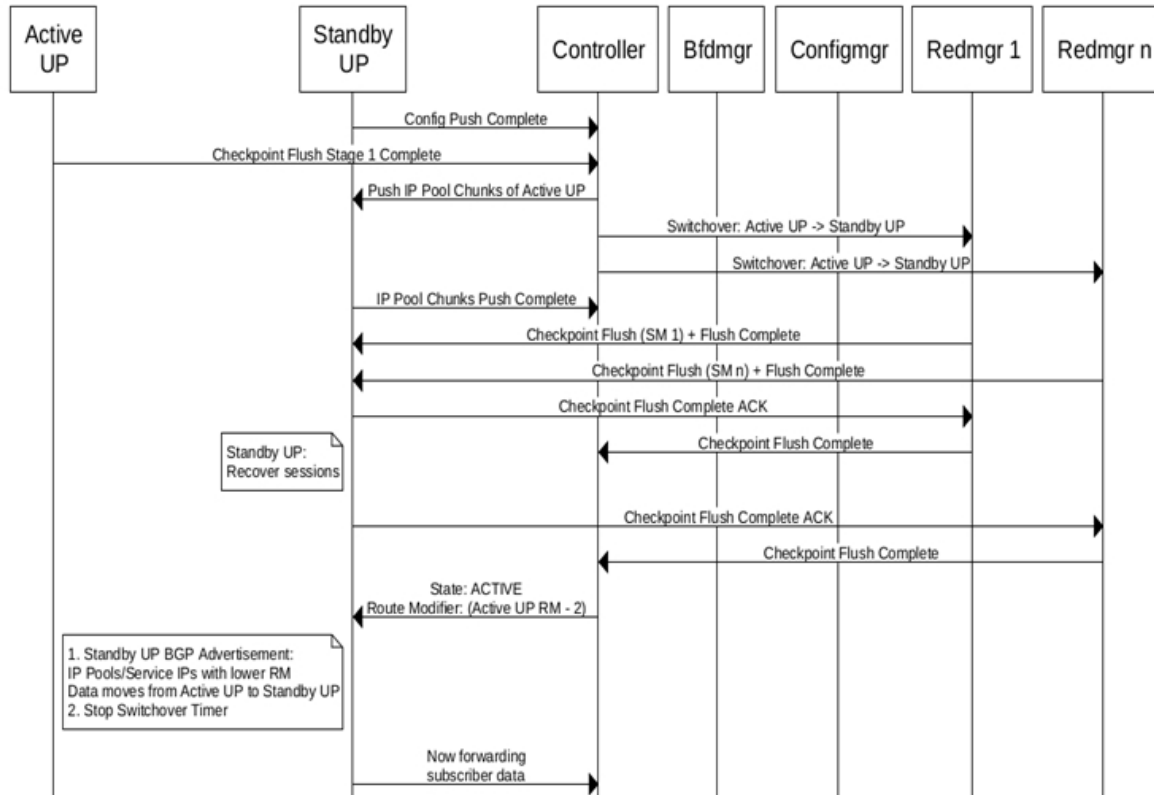

Planned Switchover (continued 3 of 3)

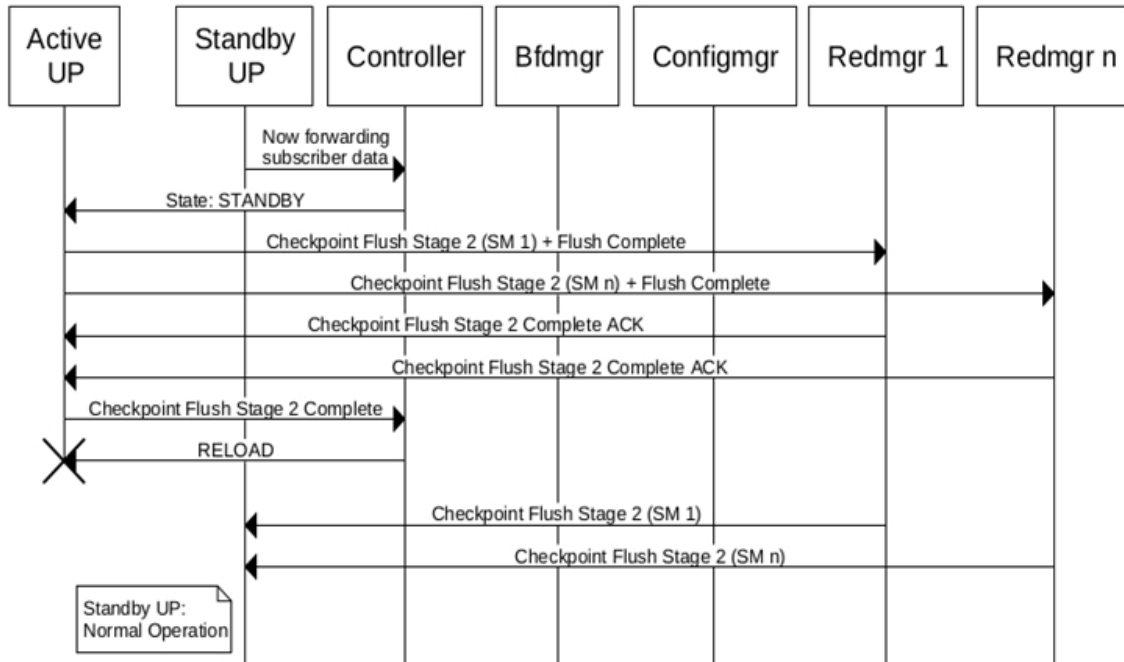

Unplanned Switchover

Unplanned switchovers occur due to issues in the UP and it gets rebooted without manual intervention. When unplanned switchover happens, the BFD monitor pod detects that the UP has gone down and triggers the RCM Controller to start switchover mechanism. The RCM controller chooses a Standby UP and the Redundancy Manager pods to start pushing configuration and checkpoints to the new UP.

The following image illustrates the call flow for an unplanned switchover.

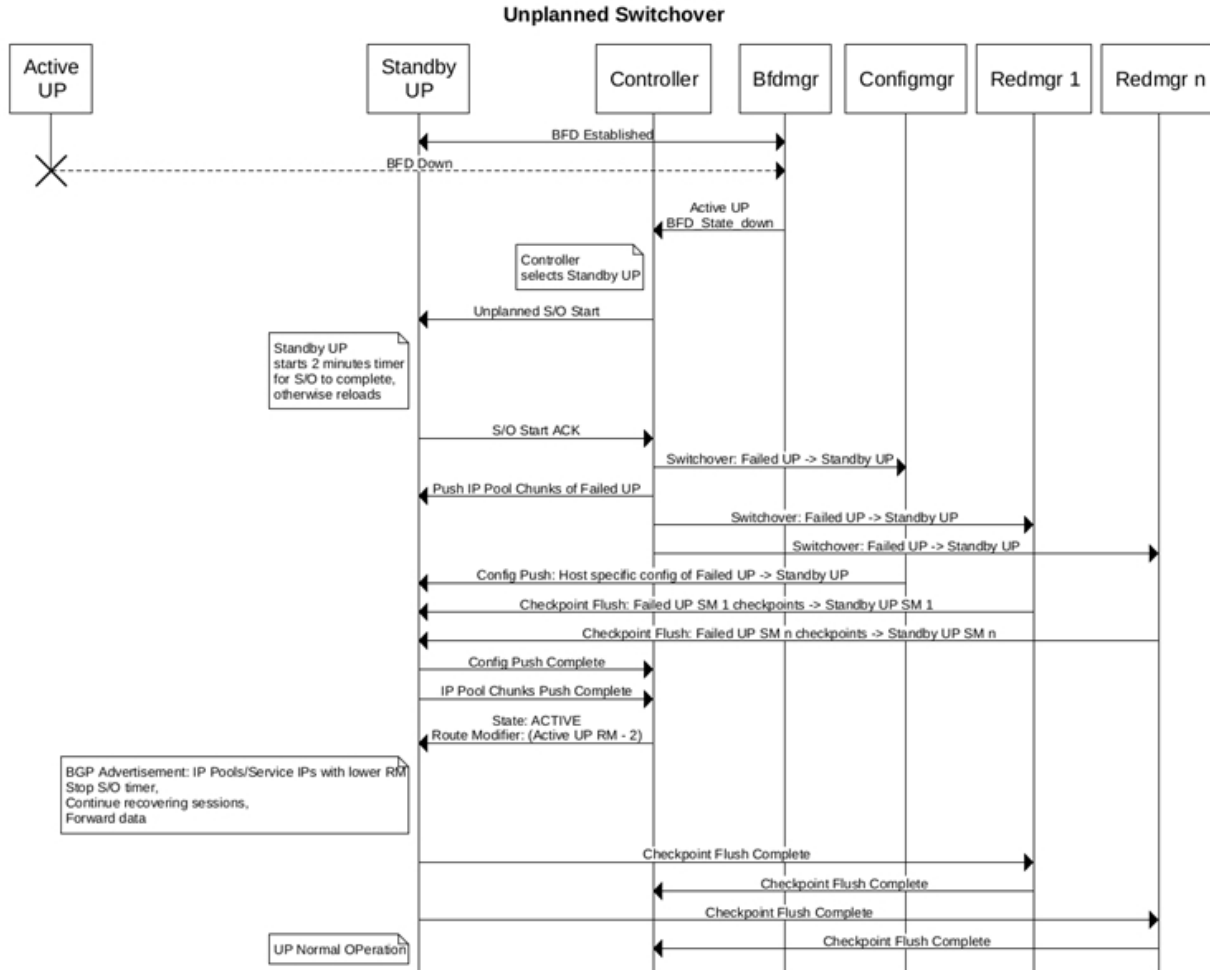

Failover Time Optimization for Unplanned Switchover

The minimum time taken by the new UP to become Active and process traffic is determined by the following factors:

- Failure detection of the Active UP
- Configuration/IP Pool Flush from RCM
- Checkpoints Flush from RCM
- Active State transition and Route Convergence

As part of this functionality, the **switchover allow-checkpoint-processing-active** CLI command is introduced that allows Active state to be pushed immediately after the “Config Push Complete”, and checkpoints are processed even after the chassis moves into Active state. This results in reducing the overall Failover time.

NOTES:

- If the “Config Pushed” time is more than the “Checkpoint Flush” time, this optimization will not yield the expected Failover time reduction.
- Failure Detection time optimization is currently not supported.

For information about the CLI command, refer the *Configuring Failover Time Optimization for Unplanned Switchover* section.

Monitoring TCP Connections using Heartbeat Communication

The application-level heartbeat mechanism between UPF and RCM allows you to monitor the health of the TCP connection. This feature resolves the half-closed TCP connections between RCM checkpoint managers and UP session managers.

RCM sends a heartbeat message every 3 seconds. It checks if it has received the heartbeat message from UPF in the last 60 seconds. RCM will close the TCP connection if it has not received the message. This behavior is applicable for both Active UP to RCM and RCM to Standby UP communication.

UPF also behaves similarly where it sends a heartbeat message every 3 seconds. UPF checks if it has received the heartbeat from RCM in the last 60 seconds. If UPF has not received the message, then it will close the TCP connection.

As part of RCM checkpoint manager hardening, UPF supports the heartbeat mechanism between UP sessmgr and RCM checkpoint manager.

MOP to Configure Heartbeat Communication

To enable heartbeat communication, perform the following steps:

1. Reload the standby UP in the build where the feature is supported.
2. Change boot priority to have the supported build in one active UP and perform an RCM-initiated planned UP switchover from this active UP to the standby UP mentioned in Step 1.
3. Upgrade the remaining active UPs by following the procedure in Step 2.
4. Upgrade RCM to the build where the feature is supported. The backup RCM must be upgraded first. Once upgraded, do a planned RCM HA from the other RCM instance, and upgrade the current backup RCM.
5. Enable heartbeat in both RCM using the following command:

```
[rcm-aio2/cndp-rcm1] rcm(config)# k8 smf profile rcm-config-ep enable-up-heartbeat true
```
6. Enable the heartbeat in the standby UP by configuring the **up-sm-heartbeat enable** CLI command under RCM module in the boot config and then reload. After it comes up, register with RCM and config push complete. Wait till the sessmgr-checkpointmanager socket connections are in Standby Ready state.
7. Enable heartbeat in the active UPs in the boot config and the running configuration. Once the sessmgr-checkpointmanager socket connections are in Active Ready state, check if calls are getting checkpointed. Use the **show rcm checkpoint statistics verbose** command to verify the checkpointed connections.
8. Perform a UP switchover and check whether calls are recovered. If it works as expected, the feature is successfully enabled.

To disable heartbeat communication, perform the following steps:

1. Disable heartbeat in RCM using the following command:

```
[rcm-aio2/cndp-rcm1] rcm(config)# k8 smf profile rcm-config-ep enable-up-heartbeat false
```
2. Change the boot config of the standby and active UPs with the **up-sm-heartbeat disable** command. Reload the standby UP to re-register with RCM and config push complete.
3. In the active UPs, disable heartbeat in the running config with the **up-sm-heartbeat disable** command.
4. Check whether checkpointing works from the active UPs using the **show rcm checkpoint statistics verbose** command. Using the same CLI, check if the sessmgr-sockets are in proper state in both active and standby UPs. It must be Active Ready in the active UP and Standby Ready in the standby UP.

Configuring Heartbeat Mechanism

Use the following configuration to configure the heartbeat mechanism.

Configuring Heartbeat in RCM

To enable or disable the heartbeat from RCM to active or standby UPF, use the following configuration in RCM:

config

```

k8 smf profile rcm-config-ep enable-up-heartbeat { true | false }

end

```

To verify the total number of heartbeat messages received and sent, use the following command:

```
rcm show-statistics checkpointmgr-endpointstats
```

Configuring Heartbeat in UPF

To enable or disable the heartbeat from UP session manager to RCM checkpoint manager, use the following configuration in UPF:

configure

```

context context_name

  redundancy-configuration-module rcm_name

    up-sm-heartbeat { enable | disable }

  end

```

To verify the total number of heartbeat messages received and sent, use the following command:

```
show rcm checkpoint statistics sessmgr all
```

Configuring Socket Write Timeout

The TCP socket from RCM Controller or RCM CheckpointMgr towards UPF SessMgr could get blocked. The socket write timeout configuration can determine the timeout if the TCP socket gets blocked. If an error such as I/O timeout is seen in the Controller or CheckpointMgr logs, you can try increasing the timeout value. You can configure the write timeout value based on your tolerance requirements.

Use the following configuration to configure socket write timeout from RCM Controller to UPF:

```
k8 smf profile rcm-config-ep upf-write-timeout write_timeout_value
```

write_timeout_value must be an integer ranging from 300 to 60000 milliseconds. The default value is 1000 milliseconds.

Use the following configuration to configure socket write timeout from RCM CheckpointMgr to UPF:

```
k8 smf profile rcm-config-ep write-timeout write_timeout_value
```

write_timeout_value must be an integer from 1 to 60000 milliseconds. The default value is 10000 milliseconds.

Configuration Management

Configuration Manager (ConfigMgr) module is required irrespective of whether redundancy is enabled or not. It is responsible to load the requested configuration for UP.

How it Works

- On successful registration of UP with the RCM, the Controller provides the Management IP of the UP. For details, see [UP Registration Call Flow](#).
- ConfigMgr receives the information of all Management IPs from the Controller.
- ConfigMgr pushes the UP Day-1 configuration to UP through SSH connection.

NOTE: If NSO is the configurator, the Day-1 configuration is pushed by NSO and not by ConfigMgr.

- Configmgr communicates with Controller over the gRPC link and exchanges the information.

The following figure depicts how the configuration works when RCM is used.

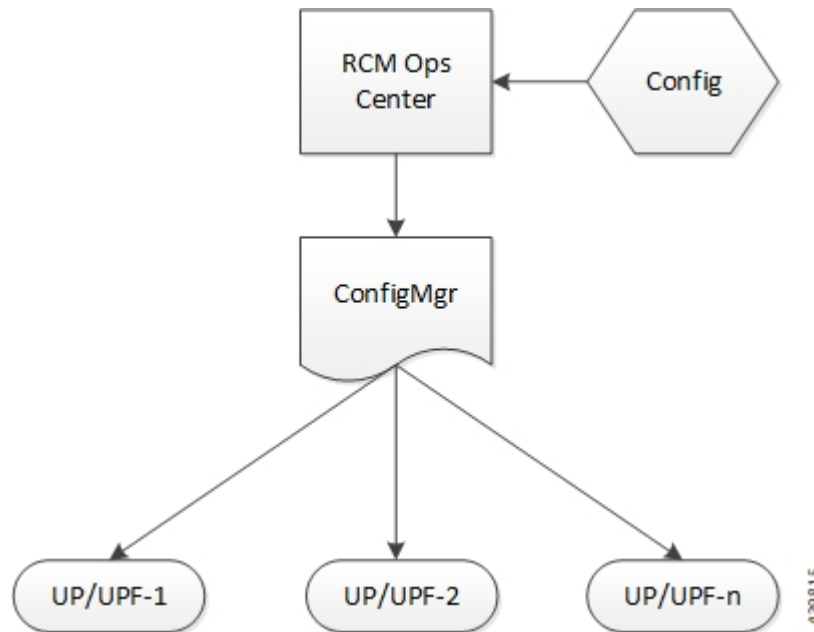

The ConfigMgr Pod is used to take the user input (configuration) from the Ops Center CLI and convert it into the corresponding StarOS CLI. The converted CLI is then pushed to the registered UP/UPF over SSH.

NOTE: The ConfigMgr Pod comes up only after the required CLI commands are configured in the Ops Center. Similarly, the UP/UPF node must have the appropriate CLI commands configured for it to connect to the ConfigMgr Pod. In the absence of the CLI commands, the UP/UPF node will not attempt to connect to the ConfigMgr for registration.

The following is the sequence of distributing UP/UPF-specific configuration to all the registered UP/UPFs.

1. The required configuration is applied in the Ops Center to bring up the ConfigMgr Pod. For details, see the [Configuring the ConfigMgr Pod](#) section.
2. The policy-charging related configuration is applied to generate the respective configuration maps. This is required for the ConfigMgr Pod to come up.
3. The UP/UPF node is configured with the required CLI commands to start the registration process with the ConfigMgr. For details, see [Configuring UP with Day-0 Configuration](#) section.
4. On successful registration, the UP/UPF receives the configured CLIs (configured as part of Step 2) over SSH.

Performing Planned Switchover

Use the following CLI command in Exec mode to perform planned switchover from Active to Standby User Plane.

```
rcm switchover source source_ip_address destination dest_ip_address
```

NOTE:

- The *source_ip_address* and the *dest_ip_address* are the RCM interfaces that you bind under `redundancy-configuration-module` mode.

Deferring SSH IP Installation

After UP is up, the Day-0.5 configuration is executed on UP. When UPs register with RCM, the Controller pushes the hostID and SSH IP to UP along with the state. The SSH IP received may get configured and saved as a part of Day-0.5 configuration. To avoid that, we must defer the SSH IP installation until the Day-0.5 configuration is saved.

The Deferring SSH IP Installation functionality is CLI-controlled. Before applying Day-0.5 configuration, you must execute the following Exec CLI command before entering the configuration mode. After the Day-0.5 configuration is done, you must first save the boot configuration (combined Day-0 and Day-0.5 configuration), and then set the CLI to default value.

```
[ no ] rcm ssh ip install
```

NOTES:

- When `rcm ssh ip install` CLI command is executed, the VPNMgr in UP activates the SSH IP received from the Controller.
- When `no rcm ssh ip install` CLI command is executed, the VPNMgr defers the SSH IP installation until it is enabled again.
- By default, the CLI command is set to enabled state (`rcm ssh ip install`). After the VPNMgr receives the SSH IP from RCM Controller and finds that the SSH IP installation is disabled, it triggers the timer to defer the SSH IP configuration and rechecks the flag after every one second. Whenever the timer times out, it checks for the disable flag and if the flag is set in false state, only then it proceeds with SSH IP activation.
- You can verify the status of SSH IP installation by using `show rcm info` CLI command.

Important NOTE: This CLI is intended only for deployment scenario and must be kept to its default value of `rcm ssh ip install` during normal operation. Outside of deployment window, the behavior of `no rcm ssh ip install` is undefined.

Redesigning Configuration Manager to Support Large Common Configurations

When the common configuration for a redundancy group exceeds 80K lines, the configuration map that is created in the RCM exceeds 1 MB, which is the defined hard limit for the combined size of all the configuration maps created out of a single repository. When the RCM supports more than one redundancy group also, you must extend this hard limit as it turns out to be a very crucial limit. This feature extends the existing hard limit to support large common configurations.

The following CLIs are added for CLI notification support in Ops-center.

```
[ no ] k8 smf profile rcm-config-ep commo-config redundancy-group group-id  
file file-name
```



```
k8 smf profile rcm-config-ep common-config update redundancy-group group-id
```

Mount the host directory on the configuration manager pod by mounting the path as follows:

```
spec:
  template:
    spec:
      volumes:
        -name: common-config
      hostPath:
        path: /data/<rcm ns>/common_config
        type: Directory
      containers:
        VolumeMounts:
          -name: common-config
            mountPath: /config/common_config
```

Configuration Manager receives the following notifications from the RCM-Ops-center:

- To apply the configuration file entirely through the configuration (no) mode.
- To update the configuration with the day N update.

How it Works

You can use this feature by completing the following procedure.

5. A new script **apply_config_v2.sh** is available as part of the VM image's file system.
6. In the same directory, define the **connect_file** as described in the following example:

```
ubuntu@bg126-pl-cups1:~/rcm-scripts/config$ cat connect_file
#Testing
#VM:VMUSERNAME:VMPASSWORD:OPCENTER:OPCUSERNAME:OPCPASSWORD:OPC_EXTERNALIP
1.2.3.4:root:starent:rcm:admin:Mitg@123:1.2.3.4
```

7. Create the directory **/data/<rcm_ns>/common_config/** in the RCM VM as root user. This step is very important as it enables the display of the **Configmgr** pod.
8. Use the root credentials of RCM VM specified in the **connect_file**. Root credentials are mandatory as you copy the file to RCM VM and the permissions of the encrypted configuration file must be a minimum of 644 KB in size.
9. Expose the ops-center IP using the following CLI command. This is not a mandatory step as it is executed by the script. If you run the script remotely, this step is then required.

```
kubectl expose deployment ops-center-rcm-ops-center-type = LoadBalancer
-name = ops-center-rcm-ops-center-cli -- port = 2024 -- target-port =
2024 -n rcm -- external-ip = RCM_VM_IP
```

RCM_VM_IP — Any IP that is reachable from the Host machine in which you can run the script.

10. Disable the string based common configuration map from the ops-center using the following CLI command.

```
config
    k8 smf profile rcm-config-ep disable-cm common
    commit
end
```

Applying the First time Configuration File

```
bash -x ./apply_config_v2.sh -g 1 -n -c UPCommon.cfg -P  
/data/<rcm_ns>/common_config/config4.cfg -G 4 -p connect_file
```

-g1 — It is a group ID and must be an integer.

-n — New configuration file. Use to change a configuration file name.

-c UPCommon.cfg — Apply the StarOS configuration file.

-P /data/<rcm_ns>/common_config/config3.cfg — Use this path in RCM VM to copy the file.

-p connect-file — This file provides all the information about the RCM VM and RCM ops-center credentials to login, copy, and apply the configuration in the RCM ops-center.

Note the password as the same password must be used for configuration update.

No Config Command

```
bash -x ./apply_config_v2.sh -g 1 -r -G 4 -p connect_file
```

-r — Specifies that it is a “no common config” for this group.

Backward Compatibility

To move back to string-based approach, re-enable the cm “common” with this configuration change.

```
config
    no k8 smf profile rcm-config-ep disable-cm common
    commit
end
```

Limitations and Restrictions

Place the configuration file in a directory that is mountable by the configuration manager. For the configuration manager to read the file, the file must be placed in the **/data/<rcm_ns>/common-config** directory.

The supported host configuration and common configuration combinations are described as follows.

The following combinations are supported with RCM as the configurator:

How it Works

- Host Configuration: String-based Approach
- Common Configuration: String-based or File-based Approach

The following combinations are supported with NSO as the configurator:

- Host Configuration: Yang-based Approach
- Common Configuration: Not applicable as NSO pushes the common configuration

Preventing Dual Active Error Scenarios

Use the following CLI configuration in CP to prevent dual Active error scenarios for N:M redundancy.

configure

```

user-plane-group group_name
    sx-reassociation disabled
end

```

NOTE:

- **sx-reassociation disabled**: Disables UP Sx reassociation when the association already exists with the CP.

Preventing Successive Switchover Due to Sx Monitor Failure

Use the following CLI configuration in RCM to prevent successive switchover due to Sx Monitor Failure.

```
k8 smf profile rcm-config-ep switchover disallow-swo-timeout timeout_seconds
```

NOTE:

- **switchover disallow-swo-timeout timeout_seconds**: Specifies the timeout value to wait after receiving an Sx Monitor Failure. *timeout_seconds* is the interval in seconds.

Example Ops Center Host-specific Configuration

```

svc-type upinterface
redundancy-group 1
...
host Active2
    host 1 config
    host 2 " context EPC2"
    host 3 " interface S5_SGW_PGW_loopback_up2 loopback"
    host 4 " ip address 192.168.170.99 255.255.255.255"
    host 5 " #exit"

svc-type cpgrp

```

Configuring the RCM

```
redundancy-group 1
  host Active2
    host 0 config
    host 1 "control-plane-group g1"
    host 2 "peer-node-id ipv4-address 192.168.196.10"
    host 3 exit
    host 4 end

    host 10 "config"
    host 11 "context rcm"
    host 12 "redundancy-configuration-module rcm"
    host 13 "monitor sx context EPC2 bind-address 192.168.170.99 peer-address
192.168.196.10"
    host 14 "end"

  exit
exit
exit
```

NOTE: The **monitor sx context EPC2 bind-address 192.168.170.99 peer-address 192.168.196.10** CLI command must be part of "cpgrp svc-type" so that this configuration is pushed only to Actives during the Day1 config-push. Only at the time of switchover, this configuration is pushed to new Active.

Configuring the RCM

This section describes how to configure the RCM.

Configuring the Controller Pod

Use the following CLI configuration to configure the endpoint to bring up the RCM Controller pod.

```
configure
  endpoint rcm-controller
    vip-ip ip_address
  exit
```

NOTES:

- **vip-ip** *ip_address*: Specifies the host IP address.
- This command is disabled by default.

Configuring the BFD Manager Pod

Use the following CLI configuration to configure the endpoint to bring up the RCM BFD Manager pod.

configure

```
    endpoint rcm-bfdmgr
```

```
    vip-ip ip_address
```

```
    exit
```

```
k8 smf profile rcm-bfd-ep bfd-monitor group group_id
```

```
k8 smf profile rcm-bfd-ep host-networking { true | false }
```

```
k8 smf profile rcm-bfd-ep node-port-enabled { true | false }
```

```
k8 smf profile rcm-bfd-ep setvar bfd-src-ip ip_address
```

```
    endpoint ipv4 ip_address
```

```
    endpoint ipv4 ip_address
```

```
    endpoint ipv4 ip_address
```

```
    min-tx-int tx_microseconds
```

```
    min-rx-int rx_microseconds
```

```
    multiplier count
```

```
    standby count
```

```
    exit
```

NOTES:

- **k8 smf profile:** Specifies the Kubernetes (k8) SMF configuration with the external IP or port configuration.
- **rcm-bfd-ep:** Specifies the BFD endpoint parameters.
- **bfd-monitor:** Specifies the BFD application configuration.
- **group group_id:** Specifies the group ID.
- **bfd-src-ip:** Specifies the source IP of BFD packets.
- **standby count:** Specifies the number of required Standby UP/UPFs.
- **vip-ip ip_address:** Specifies the host IP address.
- This command is disabled by default.

Configuring the ConfigMgr Pod

Use the following CLI configuration to configure the endpoint to bring up the RCM Configuration Manager pod.

configure

```
    endpoint rcm-configmgr
```

```
exit
```

NOTES:

- The UP credentials are passed to Configuration Manager as K8s secret. You must create these credentials before you start the RCM cluster. For details, see [Configuring UP Credentials](#) section.

Configuring UP Credentials

Use the following CLI commands to configure the credentials for UP.

config

```
k8 smf profile rcm-config-ep upfloginmode { upfcredentialsbased |
upfsshkeybased }
```

```
exit
```

NOTES:

- **upfloginmode**: Specifies the mode of UP/UPF login.
- **upfcredentialsbased**: Specifies the default or unique credentials per UP/UPF for username/password. This is the default option.
- **upfsshkeybased**: Specifies the default or unique credentials per UP/UPF for username/SSH-Key.

Sample Configuration for Credential-based UP Login

```
k8 smf profile rcm-config-ep upfloginmode upfcredentialsbased
k8 smf profile rcm-config-ep rcm-upfinfo group group_name
upf-default-cred username username
upf-default-cred password password
host-id active active_name1 management-ip ip_address
host-id active active_name2 management-ip ip_address
...
...
...
host-id standby standby_name1 management-ip ip_address
...
...
...
upf mgmt-ip up1_mgmt_ip upfcredentials username username password password
upf mgmt-ip up2_mgmt_ip upfcredentials username username password password
...
```

Configuring the RCM

...

...

```
upf mgmt-ip up_n_and_m_mgmt_ip upfcredentials username username password
password
```

NOTE:

- **upf mgmt-ip up_n_and_m_mgmt_ip upfcredentials username username password password:** These credentials are required only for per-UP unique-credential scenario.
- *active_name1*, *active_name2*, and so on, must be same as host names under host configuration.
- **management-ip ip_address** and **mgmt-ip up_n_and_m_mgmt_ip** are the IP address of UP/UPF over which configuration push happens.
- *standby_name1* can be any name.

Sample Configuration for SSH Key-based UP Login

```
k8 smf profile rcm-config-ep upfloginmode upfsshkeybased
```

```
k8 smf profile rcm-config-ep rcm-upfinfo group group_name
```

```
upf-default-sshkeys username username
```

```
upf-default-sshkeys private-key private_key
```

```
upf mgmt-ip up1_mgmt_ip upfsshinfo username username private-key private_key
```

```
upf mgmt-ip up2_mgmt_ip upfsshinfo username username private-key private_key
```

...

...

...

```
upf mgmt-ip up_n_and_m_mgmt_ip upfsshinfo username username private-key
private_key
```

NOTE:

- **upf mgmt-ip up_n_and_m_mgmt_ip upfsshinfo username username private-key private_key:** These credentials are required only for per-UP unique-credential scenario.
- After **private-key** keyword, press “Enter” for Multiline mode and then enter the private key.
- You must pass the Management IP of the UPs for configuration push.

Restricting Configuration Maps Pushed to Configuration Manager

Use the following command to restrict the configuration maps that are pushed to the Configuration Manager by default.

```
config
```

```
    k8 smf profile rcm-config-ep disable-cm { apn | apnprofile |
chargingAction | common | creditCtrl | global | gtp | gtpuService |
```

```

lawfulIntercept | misacs | nnrfService | packetFilter | rulebase | ruledef |
sxService | upSvcs | upfCpg | upfIfc | urrList }

    exit

```

NOTES:

- { **chargingAction** | **creditCtrl** | **global** | **gtp** | **gtpuService** | **misacs** | **nnrfService** | **packetFilter** | **rulebase** | **ruledef** | **sxService** | **upSvcs** | **upfCpg** | **urrList** }: Specifies the Kubernetes (k8) Session Manager function (SMF) configuration with the external IP or port configuration.
- **apn**: Restricts the Access Point Name (APN) map.
- **apnprofile**: Restricts the APN Profile map.
- **chargingAction**: Restricts the charging action map.
- **common**: Restricts the common map.
- **creditCtrl**: Restricts the credit control map.
- **global**: Restricts the content filtering and URI blacklisting map.
- **gtp**: Restricts the GTP map.
- **gtpuService**: Restricts the GTPU service map.
- **misacs**: Restricts the miscellaneous active charging services (ACS) map.
- **nnrfService**: Restricts the NNRF service map.
- **packetFilter**: Restricts the packet filter map.
- **rulebase**: Restricts the rulebase map.
- **ruledef**: Restricts the ruledef map.
- **sxService**: Restricts the Sx service map.
- **upSvcs**: Restricts the User Plane (UP) services map.
- **upfCpg**: Restricts the UP function (UP/UPF) Control Plane (CP) group map.
- **upfIfc**: Restricts the UP function (UP/UPF) Interface map.
- **urrList**: Restricts the usage reporting rule (URR) map.
-

Configuring the Redundancy Manager Pod

Use the following CLI configuration to configure the endpoint to bring up the RCM Redundancy (Checkpoint) Manager pod.

```

configure

    endpoint rcm-chkptmgr

    replicas count

    vip-ip ip_address

    exit

```

NOTES:

- **replicas count**: Specifies the number of replicas per node.
- **vip-ip ip_address**: Specifies the host IP address.
- This command is disabled by default.

Configuring Init Wait Timeout and Mass UPF Failure Timeout

Use the following RCM OpsCenter Configuration mode CLIs to configure the Init Wait timer and Mass UPF Failure timer.

```
k8 smf profile rcm-config-ep init-wait-timeout init_wait_timeout
```

```
k8 smf profile rcm-config-ep mass-upf-failure-timeout upf_failure_timeout
```

NOTES:

- **init-wait-timeout init_wait_timeout**: Specifies the Init Wait timer in seconds, as an integer from 0 to 300.
Default: 300 seconds. A value of 0 disables the Init Wait timer.
- **mass-upf-failure-timeout upf_failure_timeout**: Specifies the Mass UPF Failure timer in minutes, as an integer from 0 to 60.

A value of less than 3 minutes disables the timer. UPFs need at least three minutes to reload. When all UPFs are simultaneously reloaded as part of UPF-RCM workflow, a value of less than three minutes can potentially cause false positive alarms.

Configuring UP with Day-0 Configuration

This section describes the CLI commands that are required to configure UP with Day-0 configuration. It involves:

- Registering the UP to RCM
- Multi-hop BFD
- Configuring BGP Monitoring
- Configuring BFD Monitoring
- Configuring UP Auto-reboot
- Configuring Failover Time Reduction in RCM

NOTES:

- All UPs have Day-0 configuration with RCM context.
- The physical interfaces and port configurations are part of the Day-0 configuration.

A new context **rcm** is created in UP. The VPNMgr in UP is used to communicate with the RCM.

If RCM Redundancy is configured, use the following command to configure UP.

configure

```
context context_name
```

```

bfd-protocol

    bfd multihop-peer bfd_manager_ip_address interval tx_interval min_rx
rx_interval multiplier number_of_rx_timeouts

    exit

redundancy-configuration-module rcm_name

    bind address local_bind_ip_address

    rcm controller-endpoint dest-ip-addr control_ep port port_number

    up-mgmt-ip-addr up_mgmt_addr node-name node_name

    monitor bfd peer bfd_peer_ip_address

    monitor bgp context context_name peer-ip [ group group_number ]

    [ default | no ] rcm-unreachable triggers-reload delay
reload_interval_seconds

    [ default | no ] switchover allow-early-active-transition store-
checkpoint { enable | disable }

    exit

    ip route static multihop bfd bfd_name local_bind_ip_address
bfd_peer_ip_address

    switchover allow-checkpoint-processing-active { true | false }

end

```

NOTES:

- **redundancy-configuration-module**: Configures the Redundancy Configuration Module (RCM) and enters the RCM mode.
- **rcm**: Specifies the CUPS-related options in this context.
- **controller-endpoint**: Enables the registration of the UP at the Controller Manager endpoint.
- **dest-ip-addr** *control_ep*: Specifies the destination IP address. *control_ep* is the IP address of the Controller endpoint.
- **port** *port_number*: Specifies the TCP port value. *port_number* must be 9200.
- **up-mgmt-ip-addr** *up_mgmt_addr*: Specifies the management IP of the UP, which the Configuration Manager uses to securely connect. *up_mgmt_addr* is the IP address of the UP.
- **node-name** *node_name*: Specifies the node name of the UP to send the Configuration Manager endpoint. *node_name* is the UP node name.
- **peer** *bfd_peer_ip_address*: The *bfd_peer_ip_address* must already be configured as a multihop BFD peer session with RCM BFD Manager pod in the context *context_name*. *bfd_peer_ip_address* IP address can be different from the RCM Controller Pod IP address.

Configuring the RCM

- **group** *group_number*: [Optional] Configure to track multiple BGP peers under same monitor group. *group_number* must be in the range of 1 through 10.

If group is not specified, monitor will act as an individual monitor.

If previously configured, use **no monitor bgp context** *context_name peer-ip* CLI command to remove the BGP monitor in RCM.

UP/UPF informs RCM to trigger UP/UPF switchover under following scenarios:

- When a monitor, configured without group number, fails.
- When all the monitors, configured under single group number, fails.
- **peer** *bfd_ip_address*: The *bfd_ip_address* should already be configured as a multi-hop BFD peer session with RCM Bfdmgr pod in **context** *context_name*. This IP address can be different than the RCM Controller Pod IP address.

If previously configured, use **no monitor bfd peer** *bfd_ip_address* CLI command to remove the BFD monitor in RCM.

Configuring BFD monitor in RCM provide the following functionality:

- Switchover Scenario 1: The UP/UPF tears down TCP connection with RCM controller if BFD monitor goes down. It waits for both BFD monitor with RCM BFDMgr and TCP connection with RCM Controller to come up per configured CLI.
- Switchover Scenario 2: If UP/UPF is not in Init state and receives Init state from Controller, the UP/UPF reboots itself.

At initial boot time, UP/UPF does not initiate TCP connection with RCM Controller if BFD monitor is down.

- **switchover allow-early-active-transition**: Allows early transition to active during switchover. Traffic is processed along with the pre-allocation of other calls.
- **store-checkpoint { enable | disable }**: Enable or disable storing of checkpoints until the end of checkpoint flushing from RCM.
- **enable**: Enable storing of checkpoints and defer call pre-allocation until end of flushing.
- **disable**: Disable storing of checkpoints and allow call pre-allocation during flushing.
- **bfd multihop-peer**: Specifies the time interval within which RCM must detect failure by using a protocol such as multi-hop BFD.
- **reload_interval_seconds**: Specifies the time interval, zero (0) seconds to 30 days (in seconds), for chassis reload after BFD with RCM goes down. Default is no reload.
- **switchover allow-checkpoint-processing-active { true | false }**:
 - When set to **true**, RCM does not wait for the completion of checkpoint flush before sending Active state and lower Route Modifier to new Active UP.
 - When set to **false**, RCM waits for the completion of checkpoint flush before sending Active state and lower Route Modifier to new Active UP.
 - By default, the CLI command is set to **false**.

Configuring Planned Switchover Timers

Use the following configuration to configure the planned switchover timers in UPF.

configure

context *context_name*

```

redundancy-configuration-module rcm_name
  [ default ] planned-standby-timeout planned_timeout
  [ default ] pending-standby-timeout pending_timeout
end

```

NOTES:

- **planned-standby-timeout** *planned_timeout*: Specify the timeout for planned switchover completion, in seconds. *planned_timeout* must be an integer from 300 to 3600.
- **pending-standby-timeout** *pending_timeout*: Specify the timeout for pending Standby state, in seconds. *pending_timeout* must be an integer from 300 to 3600.

Configuring Failover Time Optimization for Unplanned Switchover

Use the following configuration to allow checkpoint processing in Active state, for a brief period, during unplanned switchover.

configure

```

context context_name
  redundancy-configuration-module rcm_name
    [ no ] switchover allow-checkpoint-processing-active
  end

```

NOTES:

- By default, the configuration is disabled.
- When this CLI command is configured under RCM context in UP, it accepts and processes checkpoints in Active state. This is done only for the Unplanned switchover initiated by the RCM. The checkpoints are accepted only till the checkpoint flush is completed from RCM. Any checkpoint that comes after flush is complete, is dropped.
- Use the **show config context** *context_name* CLI command to verify if **switchover allow-checkpoint-processing-active** CLI command is enabled.

Configuring Local Time Zone

Use the following configuration to set the local time zone in RCM Ops Center.

configure

```

k8 smf profile timezone Europe/Warsaw
exit

```

NOTES:

- **timezone Europe/Warsaw**: Specify to change the time zone for all RCM pods.
- This command causes pod restart for the value to take effect.
- It is recommended to configure this command as part of the day 0 configuration.

IP Pool Audit Configuration

Triggering IP Pool Audit Message

Use the following command in the Exec mode to trigger the IP pool audit message manually.

UPF sends the audit message to RCM. It also stops and restarts any running audit timer to maintain the periodical audit of configured IP pool chunks.

```
send-ip-pool-audit
```

Configuring IP Pool Audit Timer

Use the following configuration to configure the time interval between successive audits:

```
configure
```

```
context context_name
    redundancy-configuration-module rcm_name
        [ no ] ip-pool-audit interval audit_timer
    end
```

NOTES:

- **ip-pool-audit interval** *audit_timer*: Specify to set a time interval to repeat the auditing of IP pool information towards RCM controller. *audit_timer* is the timer value ranging from 900 to 43200 seconds.
- The default value of the timer is 1 hour.
- The **no ip-pool-audit interval** command disables the timer.

Prompting Wrong Route Modifiers

UPF and RCM controller will not accept out-of-limit route modifiers. If UPF or RCM controller receives an invalid route modifier, it disconnects TCP. On reconnecting, UPF sends the available route modifier.

The route modifier 50 is applicable to a standby UPF or RCM node only. Hence, the Active or Pending standby UPF will not accept the standby route modifier value.

Use the following configuration to prompt wrong route modifiers in both RCM and UPF:

```
configure
```

```
context context_name
    redundancy-configuration-module rcm_name
        rcm route-modifier-destination rcm_vpnmgr_ip val <2..32,50> dry-run
    { true | false }
    end
```

NOTES:

Configuring the RCM

- When **dry-run** is set to **true** (default value), it only prints the route modifier value and the UPF state will be sent to UPF.
- To send the route modifier to UPF, set **dry-run** to **false**.

Configuring LZ4 Compression Algorithm

In RCM solutions, you can choose either LZ4 or zlib compression algorithm for session checkpoints. The compression algorithm is configured in UP under RCM configurations.

For detailed configuration steps, see the *UPC CUPS User Plane Administration Guide*. Complete MOP is provided below.

In 21.23.26, 21.28.0 and later releases, perform the following steps to change the compression algorithm from zlib to LZ4:

MOP at RCM System level:

11. On RCM Ops Center, use the **rcm pause switchover true** CLI command to prevent UP(F) switchover.
12. On all UPs, update the compression algorithm to LZ4 (in Day-0.5 config and running-config) across the redundancy group level.

Use the **show config context *context_name*** or **show config url *url*** CLI command to verify if **checkpoint session compression lz4** CLI command is enabled.

13. Restart all the CheckpointMgr containers and wait for all the checkpoints to resync, or perform RCM HA.

For example,

```
kubectl -n rcm get pod rcm-checkpointmgr-0 -o yaml | grep -i "containerID:
docker
```

```
- containerID:
docker://3f7e6b10a1be3005424eae148cca2905df8e24e0a549069dfacba533c7b57bf3
```

```
sudo docker restart
3f7e6b10a1be3005424eae148cca2905df8e24e0a549069dfacba533c7b57bf3
```

```
[sudo] password:
3f7e6b10a1be3005424eae148cca2905df8e24e0a549069dfacba533c7b57bf3
```

In case of RCM HA, execute the **rcm migrate primary** CLI command on the primary RCM Ops Center.

14. Use the **rcm pause switchover false** CLI command to revert the **rcm pause switchover** value to **false**.

MOP at Redundancy Group level:

15. On RCM Ops Center, use the **rcm pause switchover true red-group *red_group_number*** CLI command to prevent UP(F) switchover.
16. On all UPs, update the compression algorithm to LZ4 (in Day-0.5 config and running-config) across the redundancy group level.

Use the **show config context *context_name*** or **show config url *url*** CLI command to verify if **checkpoint session compression lz4** CLI command is enabled.

17. On the UP, bring down the RCM interface, and then bring it up.

The following is a sample configuration to bring down the RCM interface:

Configure

```
port ethernet 1/10
```

```

vlan 2199
shutdown

```

18. On RCM Ops Center, use the **rcm pause switchover false red-group *red_group_number*** CLI command to revert the **rcm pause switchover** value to **false**.

NOTE: You must follow the same MOP to change the compression algorithm from LZ4 to zlib, replacing the keyword **lz4** with **zlib**.

Changing RCM State from Pending-Active to Active

Use the following configuration to change the RCM state from Pending-Active to Active.

configure

```

context context_name
redundancy-configuration-module rcm_name
force-pactv-to-actv-timeout value_seconds
end

```

NOTES:

- *value_seconds*: Specifies the timeout value in seconds. You must set the timeout value to *1* for immediate switchover to Active state. Immediate switchover prevents the switchback from Active to Pending-Active state.

RCM Configuration to Enable NSO as Configurator

The Cisco Network Service Orchestrator (NSO) based configuration management for 4G CUPS supports:

- Onboarding of Cisco Virtual Network Function (VNF) devices—CP, UP, and RCM
- Centralized configuration management of 4G-based CPs, UPs, and RCMs for Day-N, Day-1, and Day-0.5 CUPS configuration push.
 - Day-0.5 applies to N:M UP redundancy scheme that uses RCM. The Day-0.5 configuration is intended for the UP to communicate to the RCM, so that its role can be defined, and suitable configuration be pushed subsequently.

Managing customer configuration management for 4G CUPS deployments using NSO automation also exhibits reusability, standard notification management, and systematic device configuration governance.

For details about NSO-based Configuration Management and NSO Orchestration for 4G CUPS, refer to the *Ultra Packet Core CUPS Control Plane Administration Guide* or the *Ultra Packet Core CUPS User Plane Administration Guide*.

The RCM OpsCenter Configuration mode CLIs must be configured as follows:

```

k8 smf profile rcm-config-ep config-mode NSO
k8 smf profile rcm-config-ep switchover deployment false

```

When NSO is the configurator, the Common and Host-specific configuration with string-based approach must not be configured on RCM.

The following is an example RCM (NSO-specific) and Host-specific configuration to be configured in RCM:

config

```
k8 smf profile rcm-config-ep switchover deployment false
```

```
k8 smf profile rcm-config-ep config-mode NSO
```

The following is an example configuration that is required in RCM. The SSH IP can be random IP addresses and not any working IPs.

```
k8 smf profile rcm-config-ep disable-cm apn gtpb creditCtrl packetFilter
urrList ruledef rulebase miscacs global chargingAction lawfulIntercept
apnprofile common
```

```
k8 smf profile rcm-config-ep rcm-upfinfo group 1
```

```
host-id active Active1 ssh-ip 1.1.1.1 management-ip 1.2.3.10
```

```
host-id active Active2 ssh-ip 1.1.1.2 management-ip 1.2.3.11
```

```
host-id standby Standby1 ssh-ip 1.1.1.3 management-ip 1.2.3.12
```

```
upf mgmt-ip 1.2.3.10
```

```
upf mgmt-ip 1.2.3.11
```

```
upf mgmt-ip 1.2.3.12
```

```
exit
```

Preventing Multiple Configuration Push Notifications

To prevent multiple configuration push notifications toward NSO, the following CLI command is introduced in 21.26.4 and later releases:

```
k8 smf profile rcm-config-ep disable-repeat-config-push { true | false }
```

By default, the CLI command is set to **false**.

Sample Configuration

The following is an example configuration on RCM pushed from NSO that is present in NSO as a separate file per Active UP:

```
control-plane-group g1
  redundancy-group 1
    host Active1
      peer-node-id ipv4-address 192.168.196.10
    exit
  host Active2
    peer-node-id ipv4-address 192.168.196.10
```

Configuring the RCM

```
    exit
exit
context EPC2
interface-loopback S5_SGW_PGW_loopback_up1
    redundancy-group 1
    host Active1
    ipv4-address 192.168.170.77/32
    exit
exit
exit
interface-loopback S5_SGW_PGW_loopback_up2
    redundancy-group 1
    host Active2
    ipv4-address 192.168.170.99/32
    exit
exit
exit
interface-loopback pgw-ingress-ipv6-loopback_up1
    redundancy-group 1
    host Active1
    ipv6-address bbbb:aaaa::14/128
    exit
exit
exit
interface-loopback pgw-ingress-ipv6-loopback_up2
    redundancy-group 1
    host Active2
    ipv6-address bbbb:aaaa::16/128
    exit
exit
exit
interface-loopback pgw-ingress-loopback_up1
    redundancy-group 1
    host Active1
    ipv4-address 192.168.170.14/32
```

Configuring the RCM

```
    exit
  exit
exit
interface-loopback pgw-ingress-loopback_up2
  redundancy-group 1
  host Active2
  ipv4-address 192.168.170.16/32
  exit
exit
exit
interface-loopback sgw-egress-ipv6-loopback_up1
  redundancy-group 1
  host Active1
  ipv6-address bbbb:aaaa::12/128
  exit
exit
exit
interface-loopback sgw-egress-ipv6-loopback_up2
  redundancy-group 1
  host Active2
  ipv6-address bbbb:aaaa::14/128
  exit
exit
exit
interface-loopback sgw-egress-loopback_up1
  redundancy-group 1
  host Active1
  ipv4-address 192.168.170.51/32
  exit
exit
exit
interface-loopback sgw-egress-loopback_up2
  redundancy-group 1
  host Active2
  ipv4-address 192.168.170.53/32
  exit
```

Configuring the RCM

```
exit
exit
interface-loopback sgw-ingress-ipv6-loopback_up1
  redundancy-group 1
  host Active1
  ipv6-address 2001::1:48/128
  exit
exit
exit
interface-loopback sgw-ingress-ipv6-loopback_up2
  redundancy-group 1
  host Active2
  ipv6-address 2001::1:50/128
  exit
exit
exit
interface-loopback sgw-ingress-loopback_up1
  redundancy-group 1
  host Active1
  ipv4-address 101.101.102.48/32
  exit
exit
exit
interface-loopback sgw-ingress-loopback_up2
  redundancy-group 1
  host Active2
  ipv4-address 101.101.102.50/32
  exit
exit
exit
interface-loopback sx-u-ipv6-loopback_up1
  redundancy-group 1
  host Active1
  ipv6-address bbbb:aaaa::33/128
  exit
exit
```

Configuring the RCM

```
exit
interface-loopback sx-u-ipv6-loopback_up2
  redundancy-group 1
  host Active2
  ipv6-address bbbb:aaaa::35/128
  exit
exit
exit
interface-loopback sx-u-loopback_up1
  redundancy-group 1
  host Active1
  ipv4-address 192.168.170.131/32
  exit
exit
exit
interface-loopback sx-u-loopback_up2
  redundancy-group 1
  host Active2
  ipv4-address 192.168.170.33/32
  exit
exit
exit
user-plane-service up_up1
  redundancy-group 1
  host Active1
  associate control-plane-group g1
  associate fast-path service
  associate sx-service sx_up1
  associate gtpu-service pgw-gtpu_up1 pgw-ingress
  associate gtpu-service saegw-sxu_up1 cp-tunnel
  associate gtpu-service sgw-engress-gtpu_up1 sgw-egress
  associate gtpu-service sgw-ingress-gtpu_up1 sgw-ingress
  exit
exit
exit
user-plane-service up_up2
```

Configuring the RCM

```
redundancy-group 1
  host Active2
    associate control-plane-group g1
    associate fast-path service
    associate sx-service sx_up2
    associate gtpu-service pgw-gtpu_up2 pgw-ingress
    associate gtpu-service saegw-sxu_up2 cp-tunnel
    associate gtpu-service sgw-engress-gtpu_up2 sgw-egress
    associate gtpu-service sgw-ingress-gtpu_up2 sgw-ingress
  exit
exit
exit
gtpu-service pgw-gtpu_up1
  redundancy-group 1
  host Active1
    bind ipv4-address 192.168.170.14
  exit
exit
exit
gtpu-service pgw-gtpu_up2
  redundancy-group 1
  host Active2
    bind ipv4-address 192.168.170.16
  exit
exit
exit
gtpu-service saegw-sxu_up1
  redundancy-group 1
  host Active1
    bind ipv4-address 192.168.170.31
  exit
exit
exit
gtpu-service saegw-sxu_up2
  redundancy-group 1
  host Active2
```

Configuring the RCM

```
    bind ipv4-address 192.168.170.33
  exit
exit
gtpu-service sgw-engress-gtpu_up1
  redundancy-group 1
  host Active1
    bind ipv4-address 192.168.170.51
  exit
exit
gtpu-service sgw-engress-gtpu_up2
  redundancy-group 1
  host Active2
    bind ipv4-address 192.168.170.53
  exit
exit
gtpu-service sgw-ingress-gtpu_up1
  redundancy-group 1
  host Active1
    bind ipv4-address 101.101.102.48
  exit
exit
gtpu-service sgw-ingress-gtpu_up2
  redundancy-group 1
  host Active2
    bind ipv4-address 101.101.102.50
  exit
exit
sx-service sx_up1
  sx-protocol heart-beat interval 100
  sx-protocol heart-beat max-retransmissions 10
  sx-protocol heart-beat retransmission-timeout 20
```

Configuring the RCM

```
redundancy-group 1
  host Active1
    bind ipv4-address 192.168.170.77
    instance-type userplane
  exit
exit
exit
sx-service sx_up2
  sx-protocol heart-beat interval 100
  sx-protocol heart-beat max-retransmissions 10
  sx-protocol heart-beat retransmission-timeout 20
redundancy-group 1
  host Active2
    bind ipv4-address 192.168.170.99
    instance-type userplane
  exit
exit
exit
exit
nnrf-nfm-service svc-up1 //only nnrf service names should be configured
  redundancy-group 1
    host Active1
      exit
    exit
exit
nnrf-nfm-service svc-up2
  redundancy-group 1
    host Active2
      exit
    exit
exit
context billing
  edr-module active-charging-service
  redundancy-group 1
    host Active1
      cdr purge storage-limit 110
```

Configuring the RCM

```
    cdr transfer-mode push primary url
sftp://ftpxfer:ftpxfer@10.135.6.32:/data0/source/SEPGW6000 source-address
10.192.150.89

    file name SEPGW600-V9 rotation volume 60000000 rotation time 600 storage-
limit 536870912 headers edr-format-name compression gzip charging-service-
name omit trap-on-file-delete

    exit

    host Active2

    cdr purge storage-limit 111

    cdr transfer-mode push primary url
sftp://ftpxfer:ftpxfer@10.135.6.32:/data0/source/SEPGW6001 source-address
10.192.150.90

    file name SEPGW600-V10 rotation volume 60000001 rotation time 600
storage-limit 536870912 headers edr-format-name compression gzip charging-
service-name omit trap-on-file-delete

    exit

    exit

exit

lawful-intercept redundancy-group 1

    host Active1

    src-ip-addr 21.21.21.21

    exit

    host Active2

    src-ip-addr 21.21.21.22

    exit

    exit

exit

ts-bind-ip redundancy-group 1

    host Active1 Active1 ipv4-address 12.12.12.12ipv6-address
2001:2345:abcd::12

    host Active2 Active2 ipv4-address 12.12.12.13ipv6-address
2001:2345:abcd::13

    exit

    exit

end
```

For sample configurations, refer [Appendix B: Sample Common and Host-specific Configurations](#)

Monitoring and Troubleshooting RCM

This section provides information about monitoring and/or troubleshooting the RCM.

Show Commands and/or Outputs

The following table lists the show CLI commands that can be used to gather RCM statistics.

Statistics/Information	Show CLI commands	Node (where CLI should be executed)
Information on the status of chassis, session, RCM controller, and so on.	show rcm info	UP
Information on the status of BGP and BFD monitor.	show rcm monitor { bfd bgp all }	UP
RCM checkpoint details	show rcm checkpoint { info statistics { active debug-info ipsecmgr { all instance ipsecmgr_instance_number } sessmgr { all instance sessmgr_instance_number } standby verbose } }	UP
Statistics of RCM SNMP event trap history. Displays details for the latest 5000 SNMP traps.	rcm show-snmp-trap history	RCM Ops Center
Statistics of RCM Controller pod	rcm show-statistics controller	RCM Ops Center
Statistics of RCM ConfigMgr pod	rcm show-statistics configmgr	RCM Ops Center
Statistics of UP BFD status	rcm show-statistics bfdmgr	RCM Ops Center
Statistics of RCM checkpointmgr pod	<ul style="list-style-type: none"> rcm show-statistics checkpointmgr-endpoint-upfAddr ipv4_address rcm show-statistics checkpointmgr-endpointstats rcm show-statistics checkpointmgr-session-upfAddr ipv4_address 	RCM Ops Center
Statistics of Switchover	<ul style="list-style-type: none"> rcm show-statistics switchover rcm show-statistics switchover-verbose 	RCM Ops Center
Summary of all RCM show commands	rcm support-summary	RCM Ops Center

SNMP Traps

RCM supports event-based SNMP traps to notify important events to an external Network Management System (NMS)/SNMP Manager by using “rcm-snmp-trapper” pod. This pod is based on the snmp-trapper module in smi-apps and supports outbound alerting.

Controller Pod

The following traps are generated by the Controller Pod:

- UPFRegistered
- SwitchoverTriggered
- SwitchoverFailure
- SwitchoverComplete
- BootTimerExpired
- MassUPFailure
- TCPConnect
- TCPDisconnect
- UPFBootComplete
- UPFStateAssigned

Configuration Manager Pod

The following traps are generated by the Configuration Manager (ConfigMgr) Pod:

- UPFAdded
- UPFDeleted
- SwitchoverAbortedByController
- SwitchoverFailure
- UPFCfgPushComplete
- UPFCfgPushFailure

Checkpoint Manager Pod

The following traps are generated by the Checkpoint Manager (ChkpointMgr)/Redundancy Manager (RedMgr) Pod:

- ActiveSessmgrConnected
- ActiveSessmgrDisconnected
- StandbySessmgrConnected
- StandbySessmgrDisconnected
- CheckpointAuditStarted
- CheckpointAuditEnded
- CheckpointFlushCompleted

Keepalived Pod

The following traps are generated by the Keepalived Pod:

- PodNotFound
- PodNotRunning

NOTE: In 21.23.x and later releases, the PodNotFound and PodNotRunning traps are obsoleted. As replacement, the RCMPodHealthCheck trap is added.

- RCMPodHealthCheck
- RCMStateChange

NOTE: In 21.23.x and later releases, the RCMStateChange trap is obsoleted. As replacement, the RCMStateChangeToFault, RCMStateChangeToActive, RCMStateChangeToStandby, and RCMControllerState traps are added.

- RCMStateChangeToFault
- RCMStateChangeToActive
- RCMStateChangeToStandby
- RCMControllerState
- RCMControllerStateUpdateFailure – This SNMP trap is raised when RCM state change through HTTP POST from RCM keepalived to RCM controller fails.

strongSwan Manager Pod

The following traps are generated by the strongSwan Manager pod:

- TunnelsDropped
- TunnelsAdded

Configuring SNMP Traps

Use the following commands to configure SNMP Trap and various parameters.

configure

```
endpoint rcm-snmp-trapper
```

```
exit
```

```
k8 smf profile rcm-snmp-trapper-ep snmp-trapper { enable | disable-trap
trap_name | v2c-target ip_address } { community public_string [ port
port_number ] | port port_number } | v3-engine-id id_string | v3-target
ip_address | clear-dflt-traps | default-external-vip ip_address | custom-port
port_number [ auth { md5 [ auth-key | port | priv { aes | aes192 | aes256 |
des | none } | user-name ] | none | sha } ] | host-networking { false | true }
| port | user-name }
```

NOTES:

- **enable**: Enables SNMP trapper.
- **disable-trap** *trap_name*: Disables the desired SNMP trap.
- **v2c-target** *ip_address*: Specifies the list of SNMP v2c trap receivers. The *ip_address* specifies the SNMP Trap Receiver hostname or IP address.
- **v3-engine-id** *id_string*: Specifies the source engine ID for v3 traps as hex string, such as 80004f. *id_string* must be a string of minimum five and maximum 32 characters.
- **v3-target**: Specifies the list of SNMP v3 trap receivers.
- **clear-dflt-traps**: Enable the default traps that are disabled by default.

The following traps are disabled by default to prevent flooding of less significant traps in the **rcm show-snmp-trap history** command:

- ActiveSessmgrConnected
- ActiveSessmgrDisconnected
- CheckpointAuditEnded
- CheckpointAuditStarted
- StandbySessmgrConnected
- StandbySessmgrDisconnected
- **default-external-vip** *ip_address*: Specifies the source IP for SNMP traps. Prior to sending any trap to the trap-receiver, this IP address is used as the source of the originating trap.
- **custom-port** *port_number*: Specifies the custom port number. This option must be used only when the **default-external-vip** *ip_address* is defined.
- **community**: Specifies the SNMP Trap Receiver community.
- **port**: Specifies the SNMP Trap Receiver port.
- **auth**: Specifies the authentication protocol to be used.
- **user-name**: Specifies the SNMP trap username.
- **host-networking** { **false** | **true** }: Configures the host networking mode or non-host networking mode.
- **md5**: Specifies that HMAC-MD5-96 authentication protocol is used.
 - **none**: Specifies that no authentication protocol is used.
 - **sha**: Specifies that HMAC-SHA-96 authentication protocol is used.
 - **auth-key**: Specifies that key to authentication protocol.
 - **priv**: Specifies that privacy protocol is used.
 - **aes**: Specifies that AES-CFB (128 bits) protocol is used.
 - **aes192**: Specifies that AES-CFB (192 bits) protocol is used.
 - **aes256**: Specifies that AES-CFB (256 bits) protocol is used.
 - **des**: Specifies that CBC-DES protocol is used.
 - **none**: Specifies that no privacy protocol is used.

Sample SNMP Trap

The following is a sample SNMP trap:

```
DISMAN-EVENT-MIB::sysUpTimeInstance = Timeticks: (43241) 0:07:12.41
SNMPv2-MIB::snmpTrapOID.0 = OID: CISCO-RCM-MIB::rcmFaultActiveNotif
CISCO-RCM-MIB::rcmFaultId = STRING: "SwitchoverTriggered" CISCO-RCM-
MIB::rcmFaultSource = STRING: "rcm-controller" CISCO-RCM-
MIB::rcmFaultSeverity = STRING: "Major" CISCO-RCM-MIB::rcmFaultTime =
STRING: 2572-0-0,0:43:0.0 CISCO-RCM-MIB::rcmFaultType = INT: 3 CISCO-RCM-
MIB::rcmFaultAdditionalInfo = STRING: "Switchover Triggered" CISCO-
RCM-MIB::rcmFaultClusterName = STRING: "k3scluster" CISCO-RCM-
MIB::rcmFaultNamespace = STRING: "rcm" CISCO-RCM-MIB::rcmFaultHostname
= STRING: "host1" CISCO-RCM-MIB::rcmFaultInstance = STRING: "host1"
CISCO-RCM-MIB::rcmVnfAlias = STRING: "*"
```

For information about MIBs, refer [Appendix C: MIBs](#)

RCM High Availability

Feature Description

The Redundancy and Configuration Management (RCM) provides a High Availability (HA) solution for User Planes (UPs). RCM enables support for N:M redundancy which minimizes the number of redundant data UPs required for your deployment. To prevent UP session loss resulting from unplanned RCM outages, the RCM can be deployed in HA mode.

Architecture

RCM HA is achieved by deploying two instances of the RCM. The RCM instances run in active and standby mode. The external IPs for each instance are configured as Virtual IPs (VIP addresses) each running the Virtual Router Redundancy Protocol (VRRP).

Depending on the Primary RCM node (for example, the Primary VRRP), one of the RCM instances assumes the active role and the other RCM instance assumes the Standby role.

When the active RCM is unavailable, then the VRRP selects the standby RCM as Primary, and this instance becomes the new active RCM. The UP automatically connects to the new RCM (as the IP address moves to new RCM). All UPs connected to the previously active RCM experience connection resets and, upon retry, they get connected to the new RCM.

The following image illustrates the RCM HA architecture.

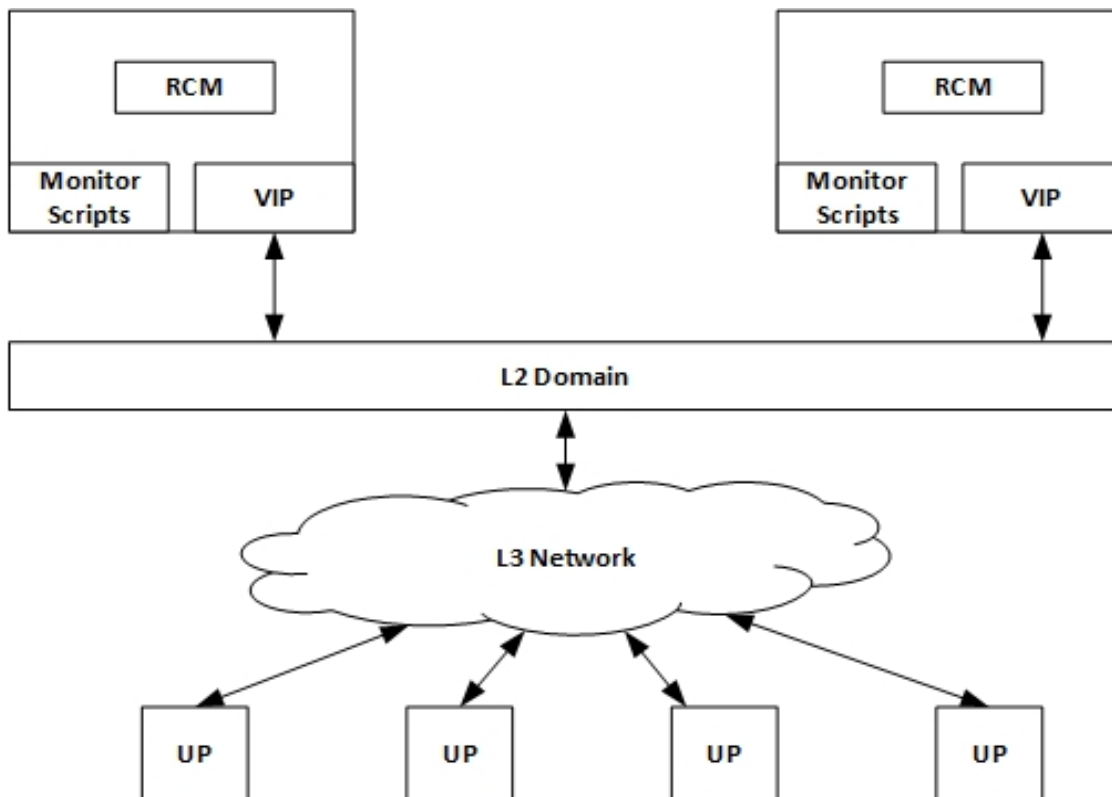

RCM HA deployments require the installation of two RCM instances instead of one. To achieve high-speed communication between the UPs and RCM, and to ensure that the UP switchover time is as minimal as possible, both RCM should be deployed in the same datacenter as the UPs for which they are providing redundancy.

How it Works

RCM HA support is based on VRRP. VRRP dynamically determines which RCM instance serves as the Primary (active) or standby (Backup) based on the assignment of the default route address.

VRRP selects the RCM instance that receives the IP address based on several factors, such as the host priority, first to be active, instance interface state (for example, “Up”), and so on. VRRP provides many options for customizing the rules for determining the Primary and Backup role for the RCM instance.

The RCM architecture is based on UP-to-RCM communication using UDP (BFD) and TCP (Controller, Checkpoint Manager) connections. The UPs are configured with BFD, Controller, and CheckpointMgr IP addresses. The UPs use these IP addresses to communicate with the RCM.

When the RCMs are deployed with HA, BFD, Controller, and Checkpoint IP addresses are configured as one IP address. This IP address, also known as external IP address, is then configured as a VIP in RCM. The VIP is managed by VRRP which determines the RCM that owns the VIP. All UPs use VIP address to communicate with the RCM. The RCM instance which owns the VIP becomes active and the other RCM instance becomes Standby.

When the active RCM reboots or relinquishes its Primary role, the VIP moves to the standby instance resulting in the standby RCM becoming active and the UPs reconnecting to newly active RCM.

The RCM’s Controller Pod learns the state of the UPs and communicates the same to the Configmgr. The Controller Pod ensures consistency of operation and decides when/if to reboot a UP to restore the system to a healthy state. UP reboots are reserved for rare, corner case scenarios.

For double-fault scenarios, (e.g. when the switchover process is left in hung state and UP reboots itself after detecting it is in hung state), the Controller sends a START_SWITCHOVER message to the UP and starts the rest of switchover process after getting an Ack from UP.

Keepalived

Keepalived is a software implementation of VRRP on Linux that runs as a pod on the RCM VM. VRRP uses the concept of a VIP. One or more hosts (routers, servers, and so on) participates in an election to determine the host that will control the VIP. Only one host (Primary) controls the VIP at a time. If the Primary host fails, the VRRP provides mechanisms for detecting that failure and quickly failing over to a Standby host.

The following flow diagram illustrates how RCM achieves HA using Keepalived.

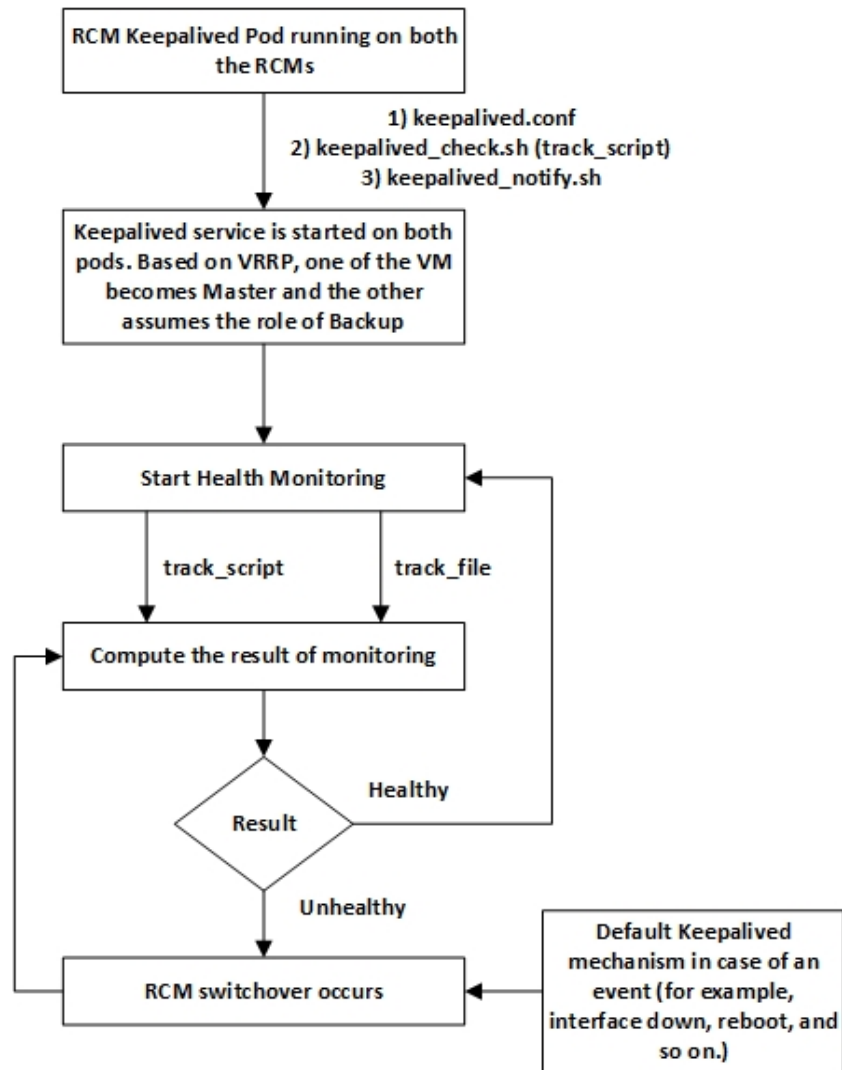

After the Keepalived pod is up and running on both the VMs, one of the RCM VMs comes up as Primary and another as Backup. Keepalived leverages the following files for proper operation:

1. **keepalived.conf**—This is the Keepalived service configuration file. It contains various Keepalived keywords to tune the service and to track VRRP (using `track_file` and `track_script` options) and notify script (`keepalived_notify.sh`) to run when VRRP instance changes the State. VIP details are part of the configuration applied through the RCM Ops Center.
2. **keepalived_notify.sh**—This is specified using the `notify_script` keyword mentioned in `keepalived.conf` file. This script takes actions when the RCM VM changes any state. For example, it specifies what action must be taken when the RCM VM transitions from Primary to a Fault State.

Both `keepalived.conf` and `keepalived_notify.sh` are a part of the Keepalived container inside the Keepalived pod. Keepalived also tracks a file using `track_file` option to keep a check on overall system health. When BFD detects all UPs are down, the RCM controller notifies Keepalived through `track_file`, the RCM is then deemed unhealthy using keepalived mechanism, and an RCM switchover occurs.

There is a possibility for events other than what is explicitly specified as part of `track_file` to occur (such as, VM reboot, interface going down, and so on). During such unspecified events, an RCM switchover event is triggered.

The following figure illustrates the States that the VRRP instance in RCM VM can transition to.

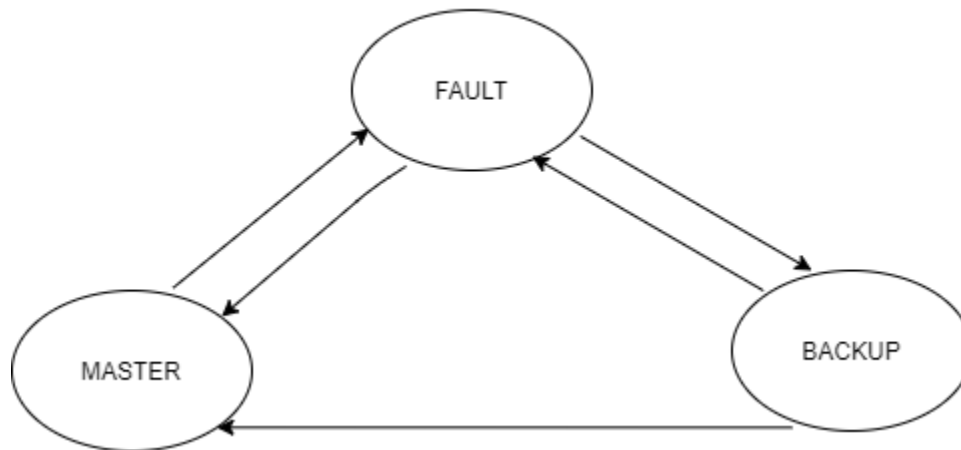

After the Keepalived pod is up and running, one of the RCM VM instances comes up as Primary and the other as Backup. When Keepalived health monitoring fails on Primary, it transitions to Fault state first and then to Backup state. At the same time, Backup transitions to Primary role. Whenever the state transitions to Fault state, the VM is rebooted. This action is done by `keepalived_notify` script.

RCM Upgrade and Downgrade Procedure in HA

In the old RCM VM:

- Take a backup of the running configuration.
- Take a backup of the configuration folders—`master`, `host`, `svc-type`—from `/var/rcm/scripts/config`

In the new RCM VM:

To upgrade the RCM image in case of `qcow2`, delete the old `vol-image`, create a new image, and restart the VM.

- Configure the back-up ops-center configuration
- Copy the backed-up contents of `master/host/svc-type` folders to their respective folders
- Perform system mode running

RCM Pause Switchover Command per Redundancy Group

RCM Pause Switchover functionality is used when there is a UP(F) reload/upgrade due to maintenance, or any other reason, and we don't want UP(F) switchover to occur.

RCM Pause Switchover Command from RCM Ops Center is applicable for all Redundancy Groups managed by the RCM. To pause UP(F) switchover only for a particular Redundancy Group, the RCM Pause Switchover Command must take the Redundancy Group number as an argument.

To achieve this functionality, the following command is introduced in Exec Mode starting 21.24 and later releases:

```
rcm pause switchover <true/false> [ red-group red_group_number ]
```

Where:

- **red-group** *red_group_number* is an optional keyword/variable. The *red_group_number* starts from 1.

In releases prior to 21.24, the following was the command in Configuration Mode:

```
k8 smf profile rcm-config-ep switchover mw-switchover-pause <true/false>
```

Prerequisites and Assumptions

RCM HA operation is based on the following prerequisites/assumptions:

- The Operator must reconfigure any delta configurations that was done on one RCM while the other RCM was in rebooting state.
- The Operator must configure both RCM instances in an identical way for updates.
- The Operator need not track which RCM instance is Active and which one is Standby.
- Only one VIP is configured per RCM. This VIP serves as IP for Controller, BFD, and Checkpoint Manager.
- All VRRP requirements, as specified in RFC3768, are needed to implement RCM HA solution. It includes:
 - The interface on which the VIP is defined for both RCM instances are part of same L2 domain.
 - The L2 switch to which the VIP interfaces are connected are multicast enabled.
- The UP is configured with five minutes BFD timeout by default. If the UP does not find RCM within the timeout period, the UP gets rebooted.
- The VRRP protocol ensures that RCM does not end up in active-active state. RCM Backup-Backup state is possible if both VIP interfaces are down.
- A new or rebooted UP may have to wait up to five minutes before getting registered with the RCM. This is expected during initial RCM bring-up and during RCM switchover.
- RCM HA does not support hot-standby wherein checkpoints are synchronized between RCM instances. RCM HA supports cold-standby. That is, upon switchover, new RCM re-learns checkpoints from the UPs.

RCM HA deployments do not assume the availability of external persistent storage.

Operational Flow

This section describes the scenarios and operation of RCM HA solution.

RCM HA Deployment

The following points describe the operational flow within RCM HA deployments:

1. The Operator brings up the RCM VMs and applies the required configurations (common and host-specific).
NOTE: The Operator reconfigures the RCM whenever it reboots.
2. One of the RCM VMs becomes active because the VRRP selects that RCM instance as Primary for the following reasons:
 - The RCM instance that comes up first becomes the Primary (provided VIP interface is up) and the other RCM that comes up later becomes Backup, OR
 - If both RCM instances come up simultaneously, then the VRRP uses a tie-breaker algorithm to select one of the RCM instances to be the Primary.
3. The active RCM starts receiving connection requests (for example, BFD messages, Controller Request, etc.) from the UPs.

4. All UPs start registering with the active RCM.
5. After registration is complete, the active RCM starts assigning active/standby roles to the UPs and configures them based on their role.
6. Active UPs start the checkpoint operation with the active RCM, and the active RCM starts managing the standby UPs.
7. When the active RCM crashes or relinquishes its role as Primary, the Backup RCM becomes active. The old active RCM either reboots or restarts the Controller Pod.

Should an RCM switchover occur, the UP detects a BFD failure and brings down the TCP connection with the Controller and Checkpoint Manager.

NOTE: The RCM switchover is triggered by moving the VIP. For UPs, the switchover is merely detected as connection failure and UPs retry the connection.

8. The UPs initiate BFD sessions with the newly active RCM and re-establish the controller TCP connection with it.
9. The UPs share information with the newly active RCM:
 - Their role (for example, Active or Sstandby)
 - The host-ID allocated to it (in case it was active)
 - Their configuration state (for example, whether a UP received the configuration or not)
10. The newly active RCM builds the state information with the information supplied by the UPs.
11. The newly active RCM resumes operation based on state information:
 - For active UPs, the it starts a full checkpoint operation.
 - For registering UPs, it determines the role and host configuration.
 - For UPs that did not receive the full configuration, it reconfigures the UP and it determines the role for new RCM.

RCM Switchover During UPs Registration/Configuration

While UP registration/Day-1 configuration is in progress, one or more of State, Host ID, and “Config Pushed” flag might not be updated on the UP. As such, the UP publishes the saved State, Host ID, and “Config Pushed” flag to the new Active RCM:

- If the State is Active, the Host ID is not null, and the Pushed flag is true → The RCM Controller accepts the information and updates the Database. It notifies the Configuration Manager service with this information and the Redundancy Manager about the state.
- If the State is active, the Host ID is not null, and the Pushed flag is false → The RCM Controller accepts the State of the UP and informs the Configuration Manager to push the configuration again.
- If the State is Active and the Host ID is null → The RCM Controller informs the UP to reboot.
- If the State is Standby and the Pushed flag is true → The RCM Controller accepts the information and updates the database. (For Standby, the Host ID is ignored, and the Standby cannot represent an Active host configuration.) It then notifies the Configuration Manager and the Redundancy Manager about the State.
- If the State is Standby and the Pushed flag is false → The RCM Controller either informs the Configuration Manager to push the configuration to the UP again or reboots the UP.

RCM Switchover During UP Switchover

1. Active UP failure is detected but switchover is not initiated: This is a scenario wherein the Active RCM detects the UP failure, however, before the UP switchover can be initiated, the Active RCM fails. In such scenarios, the new Active RCM receives Init request from the failed UP (after it reboots), and the new Active RCM assigns the appropriate role.

NOTE: Loss of sessions are expected in this scenario as the failed UP could not be switched over to standby UP.

- Active UP failure is detected, and switchover is initiated: This is a scenario wherein the Active RCM detects the UP failure and it starts the switchover. However, Active RCM fails before switchover is complete. In such scenarios, the new Active RCM receives Init request from failed UP (after it reboots), and the new Active RCM assigns the appropriate role to the UP. However, the standby UP which received partial checkpoints eventually detects that it is in hung state and so, it reboots. Upon completion of reboot, it registers with new Active RCM and the new Active RCM assigns appropriate role to the UP.

NOTE: Total loss of sessions is expected for the failed UP as switchover is not completed.

RCM Switchover During Provisioning of UP

Scaling up and scaling down of UPs is not supported for RCM.

RCM Switchover During Decommissioning of UP

Scaling up and scaling down of UPs is not supported for RCM.

Reboot of both RCMs

When both the RCMs are unavailable, the BFD restart timers on the UPs reset to a value such that UPs can continue serving until one of the RCMs is available.

RCM Switchover during Loss of Connectivity to Active UP

The Active UP loses connectivity to the RCM before the RCM switchover, the UP switchover completes, and the old Active UP reconnects to new Active RCM. The new Active UP and old Active UP have the same Host ID. The new Active RCM chooses to keep the UP with lower Route Modifier as Active and reboots the UP with higher Route Modifier.

RCM Switchover during Route Modifier Wraparound

If an Active UP registration is received with lowest Route Modifier, the RCM waits for five minutes (UP self-reboot time):

- If the time period is exceeded, the Route Modifier is wrapped around.
- If within the time period, another Active UP registration is received with same Host ID (but with higher Route Modifier), then the reboot is performed on the UP with the higher Route Modifier. The Route Modifier wraparound procedure is then started for the lowest Route Modifier UP.

Limitations

UP switchover is not supported within five minutes of RCMs switchover. If there is any switchover within this time, it is considered as double-failure and Session Recovery is not possible.

Configuring Ops Center for Keepalived Pod

Use the following parameters to configure the Keepalived pod.

```
configure
```

```
    endpoint rcm-keepalived
```

```
exit
```

```
k8 smf profile rcm-keepalived-ep vrrp-config group group_name
```

```

vrrp interface vrrp_interface

vrrp routerId router_id

ipv4-addresses address vip_address

ipv4-addresses mask address_mask

ipv4-addresses broadcast broadcast_ipaddress

ipv4-addresses device device_interface

ipv4-route route_serial_number

    destination host_network_ipv4 mask ipv4_mask gateway host_ipv4 device
interface_name

    host priority priority

    host hostid host_id

track-interface track_interface

exit

```

NOTES:

- **vrrp interface** *vrrp_interface*: Specifies the VRRP tracking interface.
- **vrrp routerId** *router_id*: Specifies the VRRP router ID.
- **address** *vip_address*: Specifies the Keepalived VIP IP address which must be same in both RCM VMs.
- **mask** *address_mask*: Specifies the VIP IP address mask.
- **broadcast** *broadcast_ipaddress*: Specifies the VIP IP broadcast address.
- **device** *device_interface*: Specifies the interface where VIP IP must be configured.
- **ipv4-route** *route_serial_number*: Specifies the Keepalived IPv4 virtual routes.
- **priority** *priority*: Specifies the VRRP host priority and must be different for both the RCM VMs.
- **hostid** *host_id*: Specifies the VRRP host ID.
- **track-interface** *track_interface*: Specifies the Keepalived track interface.

Enabling Standalone RCM without Keepalived

Use the following command when you run RCM without keepalived to force MASTER status:

```
k8 smf profile rcm-config-ep ha-standalone { true | false }
```

For example:

```
k8 smf profile rcm-config-ep ha-standalone true
```

NOTES:

- By default, the CLI command is set to **false**.

Setting IPTables Rules for Keepalived

Set the iptables rules for Keepalived using the following command in each VM:

```
sudo ufw allow in on interface_name from peer_vm_address
```

For example:

```
sudo ufw allow in on ens6.2299 from 192.168.20.247
```

NOTES:

- *peer_vm_address* must be configured to the same value specified in the keepalived.conf file.

RCM IPsec

Feature Description

Security is a very crucial aspect of any solution that meets vital customer requirements on security-related issues. RCM provides a secure computing environment and is part of a stable solution. RCM addresses both internal and external security aspects by protecting traffic between RCM and UP using IP Security (IPsec).

IPsec is a suite of protocols that interact with one another to provide secure private communications across IP networks. These protocols allow the system to establish and maintain secure tunnels with peer security gateways. IPsec provides confidentiality, data integrity, access control, and data source authentication to IP datagrams.

Architecture

The following diagram depicts the overall architecture of the RCM IPsec solution.

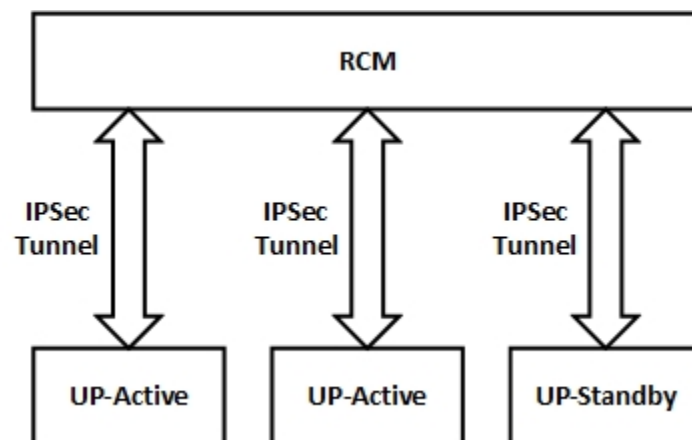

There is one IPsec (L3) tunnel between RCM and each UP. This node-level L3 tunnel between RCM and UP guarantees full protection of information exchanged between RCM and UP.

At a high-level, the RCM IPsec solution provides the following functionality:

- RCM supports multiple IPsec tunnels.
- RCM functions with or without IPsec.
- RCM supports Ops Center CLI using which IPsec can be enabled and IPsec-related information can be configured.
- Show CLI commands display details of the IPsec tunnel and IPsec data exchanged.
- RCM generates SNMP traps when the tunnel is established, released, re-established, and so on.
- Supports configuration of strongSwan with a static routing table.
- RCM HA supports reestablishment of UP with IPsec tunnel during switchover scenario.

Supported Algorithms

The RCM IPsec supports the Internet Key Exchange version 2 (IKEv2) protocol. The following table provides information about the supported options.

Protocol	Type	Supported Options
Internet Key Exchange version 2 (IKEv2)	IKEv2 Encryption	AES-CBC-128 AES-CBC-256
	IKEv2 Pseudo-Random Function (PRF)	PRF-HMAC-SHA1 PRF-HMAC-SHA2-256
	IKEv2 Integrity	HMAC-SHA1-96 HMAC-SHA2-256-128 HMAC-SHA2-384-192 HMAC-SHA2-512-256
	IKEv2 Diffie-Hellman (DH) Group	Group 14 (2048-bit) Group 15 (3072-bit) Group 16 (4096-bit)

How it Works

A single IPSec tunnel is established between RCM and UP. This tunnel carries checkpoint traffic, configuration files, VPMGR traffic towards RCM, and so on. Since configuration from RCM uses SSH, there is no need to use IPSec for SSH traffic.

To support IPSec operation, the following pod is introduced:

- **strongSwan:** Establishes the IPSec tunnel (that is, the Control Plane of IPSec)

The strongSwan runs as a pod with Host mode networking and as a Daemon process. When you enable the IPSec using Ops Center, then strongSwan pod gets created. IPSec tunnel initiation always happens from UP. The strongSwan handles the IPSec tunnel creation aspect. And, once the IPSec tunnel parameters are determined, it configures the host kernel for the IPSec data plane. The host kernel performs the encryption/decryption of IPSec traffic. When host kernel receives the encrypted packet, it decrypts the packet and punts it to the application listening on specific IPs. The strongSwan maintains the tunnel state between the RCM and the UP.

The following illustration depicts the system architecture of RCM VM.

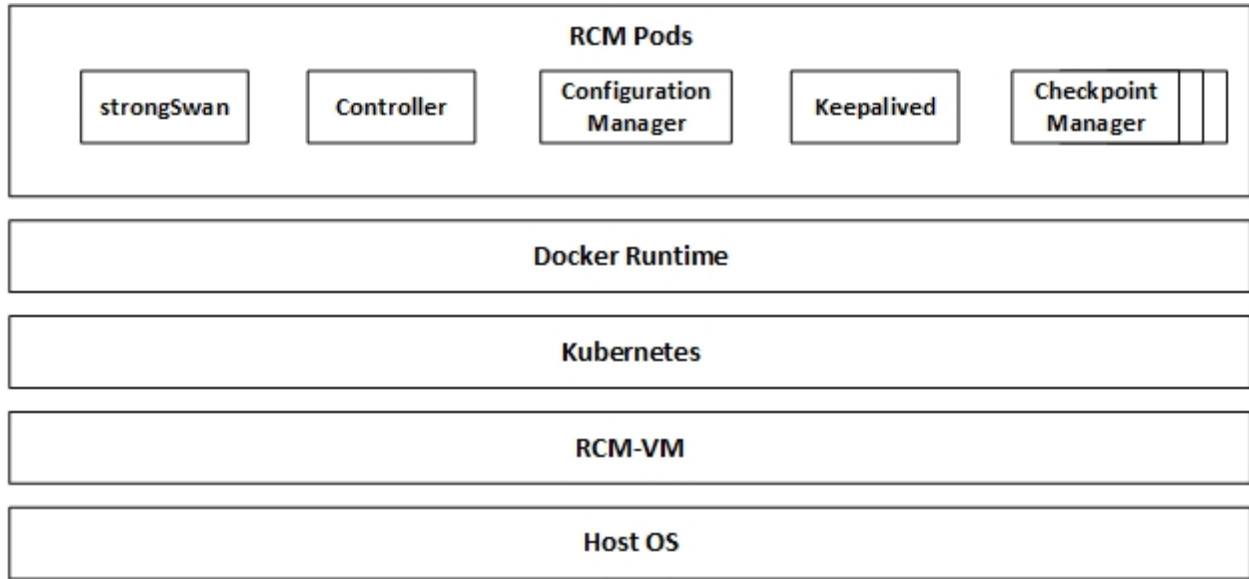

When RCM is deployed on bare metal, the RCM VM layer does not exist, and packet flow involves host kernel.

NOTE: Additional hardware for RCM is required as few cores must be dedicated for strongSwan.

RCM IPsec Tunnel Establishment

The following illustration depicts how IPsec tunnel is established between RCM and UP, and the packet flow.

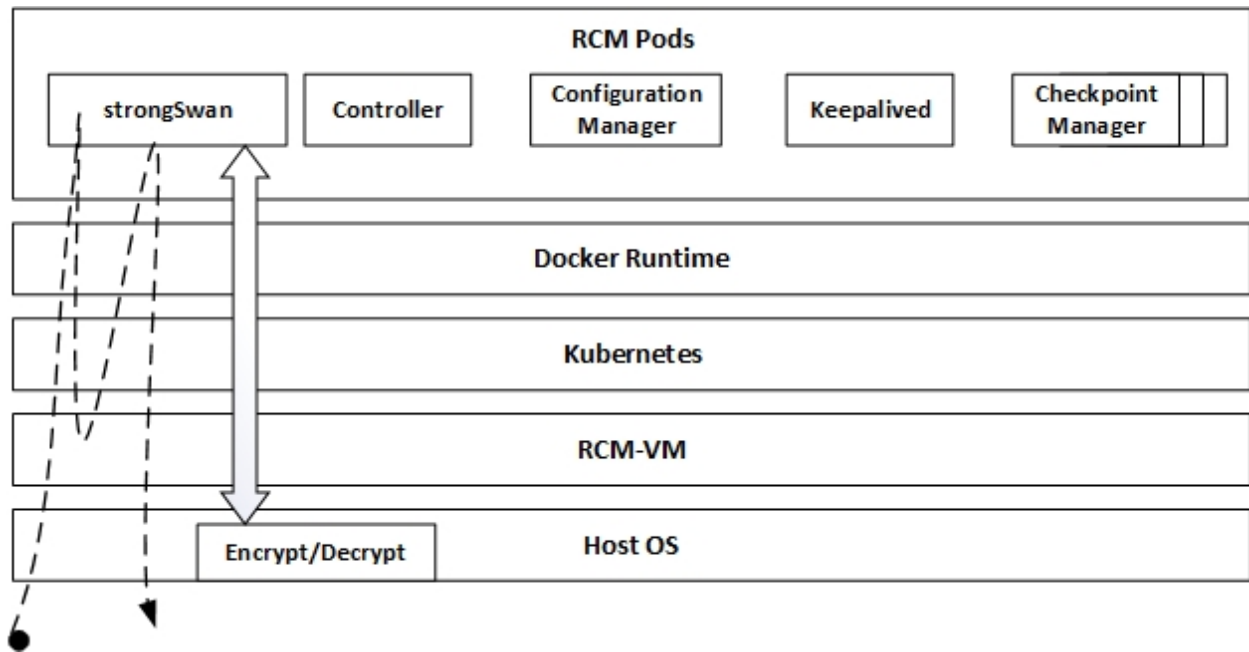

The following steps explain how IPsec tunnel is established between RCM and UP:

RCM IPsec

1. UP initiates IPsec tunnel establishment using IPsec control protocol such as IKEV1 or IKEV2. You may opt to choose only IKEV2.
2. Host kernel receives the packet.
3. The host kernel sends the packet to strongSwan.

The above steps are repeated between UP and RCM till IPsec tunnel establishment concludes.

4. After the tunnel is established, strongSwan configures the host kernel with IPsec data plane parameters.
5. Host kernel is now ready to encrypt/decrypt IPsec packet towards the UP, and strongSwan is ready to maintain the IPsec tunnels between host kernel and UP.

NOTE: Above sequence of operation is executed whenever UP establishes an IPsec tunnel.

Checkpoint Data Transfer

The following illustration depicts the checkpoint data transfer and packet flow.

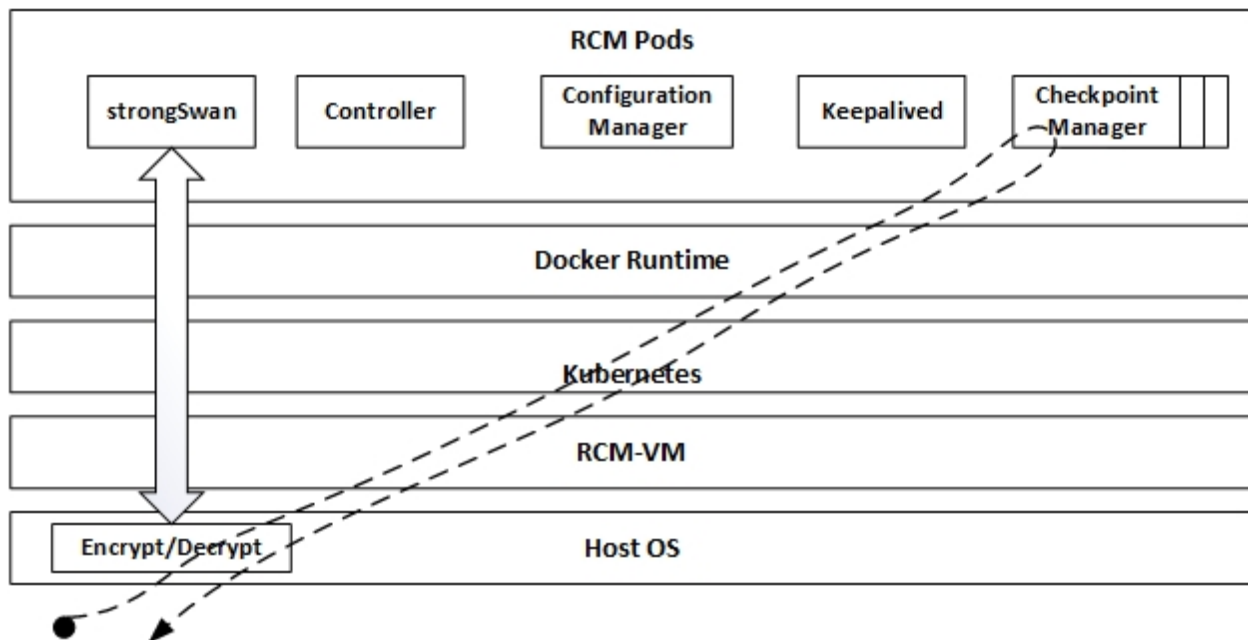

The following steps explain the sequence of checkpoint data transfer and packet flow:

1. SessMgr of UP sends checkpoint over IPsec tunnel (note that all packet between RCM and UP uses the same tunnel, and there is one tunnel between UP and RCM).
2. Host kernel receives the packet and decrypts it.
3. The host kernel sends the packet to desired checkpoint manager (essentially, this happens through Kubernetes networking).
4. Checkpoint manager processes the packet and generates a response (for example, TCP ACK).
5. The response packet is sent to the host kernel.
6. Host kernel encrypts and egresses the packet.
7. The strongSwan maintains the tunnel state between RCM and UP and also keeps count of the tunnels idle-state and count of encrypted/decrypted packets.

RCM IPSec during Switchover

During RCM switchover, Standby RCM becomes Active. During this time, UPs try reconnecting with the new RCM. However, the reconnection fails as the new RCM does not have an IPSec tunnel. To resolve this reconnection failure, IPSec keepalive timer must be configured. IPSec keepalive timer expires as new RCM does not send keepalive messages. When this happens, UP triggers the establishment of new IPSec tunnel. After the IPSec tunnel is established, all UP connections toward new RCM becomes operational, and IPSec data is exchanged.

Limitations and Restrictions

The following are the known limitations/restrictions of RCM IPSec feature:

- Dynamic change of IPSec mode is not supported.
Configuring strongSwan with static routing table is supported. Dynamic routing table update is not supported.
- By default, all ports are blocked for enhanced security. As part of RCM deployment, use the following steps to open the IPSec ports:

```
echo udp:500 >> /usr/local/etc/ports_to_allow.txt
echo udp:4500 >> /usr/local/etc/ports_to_allow.txt
echo esp >> /usr/local/etc/ports_to_allow.txt
/usr/local/bin/block_ports.sh -p /usr/local/etc/ports_to_allow.txt
```

Configuring RCM IPSec

This section provides information about the CLI commands available in support of the RCM IPSec feature.

Enabling IPSec in RCM

Use the following configuration to enable IPSec in RCM.

```
configure
```

```
    rcm-ipsec enable true
```

```
exit
```

NOTE:

- After IPSec is enabled, mandatory parameters like **left-subnet** and **right-subnet** must be configured.

Disabling IPSec in RCM

Use the following configuration to enable IPSec in RCM.

```
configure
```

```
    rcm-ipsec enable false
```

```
exit
```

Configuring IPsec Transform Set

The IPsec Transform Set Configuration mode is used to configure IPsec security parameters. Use the following CLI commands to configure the IPsec Transform Set Configuration mode.

configure

```
rcm-ipsec ikev2-ikesa transform-set  
  
exit
```

Configuring IPsec Parameters

Use the following CLI commands to configure IPsec parameters in RCM.

configure

```
rcm-ipsec ikev2-ikesa transform-set  
  
  dh-group { 14 | 15 | 16 }  
  
  encryption { aes-cbc-128 | aes-cbc-256 }  
  
  hmac { sha1-96 | sha2-256-128 | sha2-384-192 | sha2-512-256 }  
  
  left-subnet  
  
  prf { sha1 | sha2-256 }  
  
  psk aes_encrypted_string  
  
  right-subnet  
  
  exit  
  
end
```

NOTES:

- **dh-group { 14 | 15 | 16 }**: Specifies Diffie-Hellman group configuration. It configures the appropriate key exchange cryptographic strength and activates Perfect Forward Secrecy by applying a Diffie-Hellman group.
 - Group 14 provides 2048 bits of keying strength. This is the default option.
 - Group 15 provides 3072 bits of keying strength.
 - Group 16 provides 4096 bits of keying strength.
- **encryption { aes-cbc-128 | aes-cbc-256 }**: Specifies the encryption algorithm and encryption key length.
 - **aes-cbc-128**: An advanced Encryption Standard Cipher Block Chaining with a key length of 128 bits. This is the default setting for this command.
 - **aes-cbc-256**: An advanced Encryption Standard Cipher Block Chaining with a key length of 256 bits.

RCM IPsec

- **hmac { sha1-96 | sha2-256-128 | sha2-384-192 | sha2-512-256 }**: Specifies integrity algorithm using a Hash-based Message Authentication Code (HMAC).
 - **sha1-96**: Uses a 160-bit secret key and produces a 160-bit authenticator value. This is the default setting for this command.
 - **sha2-256-128**: Uses a 256-bit secret key and produces a 128-bit authenticator value.
 - **sha2-384-192**: Uses a 384-bit secret key and produces a 192-bit authenticator value.
 - **sha2-512-256**: Uses a 512-bit secret key and produces a 256-bit authenticator value.
- **left-subnet**: [Mandatory] Specifies the RCM external IP/VIP.
- **prf**: Specifies the Pseudo-Random Function (PRF) algorithm.
- **psk**: Specifies the Pre-Shared Key for peer authentication.
- **right-subnet**: [Mandatory] Specifies the RCM service IP and port for UP.

Configuring strongSwan Endpoint

Use the following CLI commands to configure the strongSwan endpoint to create the pod.

configure

```
endpoint rcm-strongswan vip-ip ip_address
end
```

Sample Configuration

The following is a sample configuration for your reference.

```
configure
rcm-ipsec enable true
rcm-ipsec ipsec transform-set
encryption aes-256-gcm-128
hmac      sha1-96
dh-group  16
exit
rcm-ipsec ikev2-ikesa timer
ikelifetime      10000
retransmit-tries  5
retransmit-timeout 99
exit
rcm-ipsec ikev2-ikesa transform-set
encryption aes-cbc-128
hmac      sha2-256-128
prf      sha1
```

Appendix A: Deployment Parameters

```
dh-group    14
psk         test
left-subnet 192.0.2.1 port 1111 prefix-length 32
left-subnet 192.0.3.1 port 1111 prefix-length 32
right-subnet 192.0.4.1 port 2222 prefix-length 24
right-subnet 192.0.5.1 port 2222 prefix-length 24
exit
```

SNMP Traps

The following traps are generated by the strongSwan Manager pod:

- TunnelsDropped
- TunnelsAdded

For the complete list of SNMP Traps available in RCM and configuration, see [SNMP Traps](#) under the [Monitoring and Troubleshooting RCM](#) section.

Appendix A: Deployment Parameters

Important NOTE: This section provides sizing parameters and recommendations based on typical deployment setup, and its solely for your reference.

Typical Deployment

Typical deployment consists of:

Appendix A: Deployment Parameters

- 10 Active UPs per RCM
- One or multiple redundancy group with total of 10 Active UPs across all redundancy groups
- Each UP with 10 SessMgrs
- Total UP capacity with 200k (approx.) sessions and per session size of 38 KB (approx.)
 - Approx. 7.2 GB for 200k sessions (Approx. 1.8 GB with compression)

Parameters

For a typical deployment, consider the following sizing parameters:

- Memory
- CPU
- Network
- Hard Disk

The required resources differ with:

- The number of UPs registered with RCM
- The number of SessMgrs in each UP
- The number of sessions in each SessMgr of an UP
- Call Events Per Second (CEPS)

Memory Sizing

For a [Typical Deployment](#) example given above:

- All checkpoints are stored in RAM
- Memory required for checkpoints for each UP is 2 GB (approx.)
- Application garbage collector takes time to free up old checkpoints
- Checkpoints are continuous (Added/Modified/Deleted)
- Based on CEPS
- Typically requires 4 GB for one UP with 200k sessions excluding operational overhead of minimum 10 GB.

To support 10 UPs with 200k sessions each and 500 CEPS, recommended size of RAM is minimum of 50 GB.

CPU Sizing

The following parameters must be considered for CPU sizing:

- The number of Checkpoint Managers (ChkpointMgrs)/Redundancy Managers (RedMgrs) should be equal to the number of SessMgrs in each UP.
- All UP has same number of SessMgrs.
- During switchover, all the ChkpointMgrs work parallelly to flush checkpoints from RCM to new Active UP:
 - To achieve true parallelism, it is recommended to have as many cores as the number of ChkpointMgrs.

Appendix A: Deployment Parameters

- Additionally, two cores for operations involving other pods.

Note: You can try with lesser number of cores if the total number of sessions are less.

Network Sizing

The following parameters must be considered for network sizing:

- Requires two interfaces:
 - RCM service interface where checkpoints are transferred
 - Management interface where SSH and SFTP of configurations can be performed

You can use RCM interface and configure in RCM context of UP. However, its recommended to keep them separate.
- Additionally, operational interface to login to the Ops Center and for NETCONF communication to configure the Ops Center. Operations interface is also used to collect logs, diagnose, alert, and so on. This interface can be same as Management interface.
- For RCM High Availability (HA), an additional L2-level network for VRRP is required.
- Speed:
 - Minimum of 25Gbps link for RCM interface for checkpoints
(Low latency as BFD runs on this interface.)
 - A basic 1Gbps link for management interface

Hard Disk Sizing

The following parameters must be considered for hard disk sizing:

- Disk space required for logging, docker images, and so on.
- It is recommended to have at least 40 GB of disk space.
- If resource crunch occurs, the pods are evicted.
- Some persistent storage to preserve data across reboots.

The following table is a typical recommendation.

Number of UPs	SessMgrs/UP	Total Sessions/RCM	Recommended Cores	Recommended Memory
5	8	1000K	10	32 GB
6	8	1200K	10	36 GB
8	10	1600K	12	45 GB
10	12	2000K	14	55 GB
10	16	2000K	18	55 GB

Appendix B: Sample Common and Host-specific Configurations

Important NOTE: This section provides sample Common and Host-specific configurations based on typical deployment setup, and its solely for your reference.

Common Configuration

The following is a sample Common configuration. All ACS-related configurations are part of Common configuration.

```
redundancy-group 1
common 0 "sleep 5 "
common 1 "config "
common 2 "active-charging service ACS "
common 3 "idle-timeout udp 60 "
common 4 "statistics-collection ruledef all "
common 5 "exit"
```

NOTE: There should be an "exit" in the Common configuration for each section, such as rulebase, ruledef, host pool, port map, and so on.

Host-specific Configuration

The following is a sample Host-specific configuration.

```
svc-type upinterface
  redundancy-group 1
  host Active1
  host 1 config
  host 2 " context EPC2"
  host 3 " interface S5_SGW_PGW_loopback_up1 loopback"
  host 4 " ip address 192.168.170.77 255.255.255.255"
  host 5 " #exit"
  host 6 " interface pgw-ingress-ipv6-loopback_up1 loopback"
  host 7 " ipv6 address bbbb:aaaa::14/128"
  host 8 " #exit"
svc-type sxsvc
  redundancy-group 1
  host Active1
  host 1 config
  host 2 " context EPC2"
  host 42 " sx-service sx_up1"
  host 43 " instance-type userplane"
  host 44 " bind ipv4-address 192.168.170.77"
  host 45 " exit"
  host 46 " end"
exit
svc-type upsvc
  redundancy-group 1
  host Active1
  host 1 config
  host 2 " context EPC2"
  host 46 " user-plane-service up_up1"
  host 47 " associate gtpu-service pgw-gtpu_up1 pgw-ingress"
  host 48 " associate gtpu-service sgw-ingress-gtpu_up1 sgw-ingress"
  host 49 " associate gtpu-service sgw-engress-gtpu_up1 sgw-egress"
  host 50 " associate gtpu-service saegw-sxu_up1 cp-tunnel"
  host 51 " associate sx-service sx_up1"
```

Appendix B: Sample Common and Host-specific Configurations

```
    host 52 " associate fast-path service"
    host 53 " associate control-plane-group g1"
    host 54 " exit"
    host 55 " #exit"
    host 56 end
exit
svc-type gtpusvc
    redundancy-group 1
    host Active1
    host 1 config
    host 2 " context EPC2"
    host 30 " gtpu-service pgw-gtpu_up1"
    host 31 " bind ipv4-address 192.168.170.14"
    host 32 " exit"
    host 33 " gtpu-service saegw-sxu_up1"
    host 34 " bind ipv4-address 192.168.170.31"
    host 35 " exit"
    host 36 " gtpu-service sgw-engress-gtpu_up1"
    host 37 " bind ipv4-address 192.168.170.51"
    host 38 " exit"
    host 39 " gtpu-service sgw-ingress-gtpu_up1"
    host 40 " bind ipv4-address 101.101.102.48"
    host 41 " exit"
    host 42 " end"
exit
svc-type cpgrp
    redundancy-group 1
    host Active1
    host 0 config
    host 1 "control-plane-group g1"
    host 2 "peer-node-id ipv4-address 192.168.196.10"
    host 3 "exit"
    host 4 "end"
    host 5 "config"
    host 6 "context <name>"
    host 7 "<LI config line1>"
```

```

    host 8 "<LI config line2>"
exit
svc-type nnrfsvc
redundancy-group 1
    host Active1
        host 2 "  config"
        host 3 "  context EPC2"
        host 4 "    nrf-nfm-service svc-up1"
        host 5 "      bind ipv4-address 192.168.170.31"
        host 6 "        associate nrf-mgmt-format prof1" //Profile
configuration should be part of UP day-0 config
        host 7 "          endpoint-name end1"
        host 8 "            ipv4-address 192.168.170.32 portv4 8802"
        host 9 "      exit"
        host 10 "    end"
    exit
    host Active2
        host 2 "  config"
        host 3 "  context EPC2"
        host 4 "    nrf-nfm-service svc-up2"
        host 5 "      bind ipv4-address 192.168.170.33"
        host 6 "        associate nrf-mgmt-format prof1"
        host 7 "          endpoint-name end1"
        host 8 "            ipv4-address 192.168.170.34 portv4 8802"
        host 9 "      exit"
        host 10 "    end"
    exit
exit
exit

```

NOTE:

1. If you have 10 active hosts, then you should have 10 active Host-specific configuration present under these services.
2. The Lawful Intercept (LI) configuration must be under "svc-type cgrp". There is no specific service for LI.

Appendix C: N:M Configuration Separation Table

CP	RCM	UP
<ol style="list-style-type: none"> 1. URR List must be explicitly configured under Active Charging Service (ACS). 2. The sx-pfd-push and sx-reassociation CLI commands under UP group must be disabled. 	<p>Common configuration:</p> <ul style="list-style-type: none"> • ACS • APN • GTPP Group (for URR generation) • AAA Group (for URR generation) <p>Host Configuration:</p> <ul style="list-style-type: none"> • Service loopback interfaces • Sx Service • GTPU Service • UP Service • NNRF Service • CP Group • Lawful Intercept (LI): LI configuration must be under CP group configuration. 	<p>Day-0 configuration</p> <p>[All physical interfaces, contexts (including RCM context), routing configurations (including BGP), bulkstats, SNMP, Syslog, and so on.]</p> <p>Day-1 (Common and Host) configuration is pushed from RCM.</p>

Appendix D: Metrics

RCM Bfdmgr Controller Event Stats Category

`bfdmgr_controller_event_stats`

Description: Number of events sent to rcm-controller

Sample Query: `bfdmgr_controller_event_stats{service_name="bfdmgr"}`Labels:

- **Label:** `endpoint`
Label Description: endpoint IP of UPF
Example: 1.1.1.1
- **Label:** `groupid`
Label Description: GroupId of the UPF
Example: 1

RCM Bfdmgr UPF Event Stats Category

`bfdmgr_upf_event_stats`

Description: Number of events received for each UPF

Sample Query: `bfdmgr_upf_event_stats{service_name="bfdmgr"}`

Labels:

- **Label:** `endpoint`
Label Description: endpoint IP of UPF
Example: 1.1.1.1
- **Label:** `groupid`
Label Description: GroupId of the UPF
Example: 1

RCM checkpointmgr Current Emergency call count Category

chkptmgr_emergency_call_count

Description: Current Number of Emergency calls checkpointed to RCM checkpointmgr Sample

Query: `chkptmgr_emergency_call_count{service_name=\"rcm-checkpointmgr\"}`

Labels:

- Label: `sessmgr_no`
Label Description: Sessmgr Number of UPE
Example: 1
- Label: `up_address`
Label Description: IP address of UP
Example: 1.1.1.1

RCM checkpointmgr Current active VOLTE call count Category

chkptmgr_volte_active_call_count

Description: Current Number of volte active calls checkpointed to RCM checkpointmgr Sample

Query: `chkptmgr_volte_active_call_count{service_name=\"rcm-checkpointmgr\"}`

Labels:

- Label: `sessmgr_no`
Label Description: Sessmgr Number of UPE
Example: 1
- Label: `up_address`
Label Description: IP address of UP
Example: 1.1.1.1

RCM checkpointmgr Current call count Category

chkptmgr_total_call_count

Description: Current Number of calls checkpointed to RCM checkpointmgr

Sample Query: `chkptmgr_total_call_count{service_name=\"rcm-checkpointmgr\"}`Labels:

- Label: `sessmgr_no`
Label Description: Sessmgr Number of UPE
Example: 1
- Label: `up_address`
Label Description: IP address of UP
Example: 1.1.1.1

RCM checkpointmgr Current non-active VOLTE call count Category

`chkptmgr_volte_non_active_call_count`

Description: Current Number of non-actove VOLTE calls checkpointed to RCM checkpointmgr Sample

Query: `chkptmgr_volte_non_active_call_count{service_name=\"rcm-checkpointmgr\"}`

Labels:

- Label: `sessmgr_no`
Label Description: Sessmgr Number of UPE
Example: 1
- Label: `up_address`
Label Description: IP address of UP
Example: 1.1.1.1

RCMcheckpointmgrCurrentnon-prioactivecallcountCategory

`chkptmgr_non_prio_active_call_count`

Description: Current Number of non-prio active calls checkpointed to RCM checkpointmgr Sample

Query: `chkptmgr_non_prio_active_call_count{service_name=\"rcm-checkpointmgr\"}` Labels:

- Label: `sessmgr_no`
Label Description: Sessmgr Number of UPE
Example: 1
- Label: `up_address`

Appendix D: Metrics

Label Description: IP address of UP

Example: 1.1.1.1

RCM checkpointmgr Current non-prio non-active call count Category

chkptmgr_non_prio_non_active_call_count

Description: Current Number of non-prio non-active calls checkpointed to RCM checkpointmgr

Sample Query: `chkptmgr_non_prio_non_active_call_count{service_name=\"rcm-checkpointmgr\"}`

Labels:

Label: `sessmgr_no`

Label Description: Sessmgr Number of UP
Example:

1

• Label: `up_address`

Label Description: IP address of UP

Example: 1.1.1.1

RCM checkpointmgr UP Audit count Category

chkptmgr_up_audit_count

Description: Count related to UP Audits in RCM checkpointmgr

Sample Query: `chkptmgr_up_audit_count{service_name=\"rcm-checkpointmgr\"}`

Labels:

• Label: `sessmgr_no`

Label Description: Sessmgr Number of UP
Example:

1

• Label: `up_address`

Label Description: IP address of UP

Example: 1.1.1.1

• Label: `state`

Label Description: Current state

Example: start/end

RCM checkpointmgr UP Flush completed count Category

chkptmgr_up_flush_completed_count

Description: Count related to UP flush completed in checkpointmgr

Sample Query: `chkptmgr_up_flush_completed_count{service_name=\"rcm-checkpointmgr\"}` Labels:

- Label: `sessmgr_no`
Label Description: Sessmgr Number of UP
Example: 1
- Label: `up_address`
Label Description: IP address of UP
Example: 1.1.1.1

RCM checkpointmgr UP connection count Category

chkptmgr_up_connection_count

Description: Count related to UP connections to RCM checkpointmgr

Sample Query: `chkptmgr_up_connection_count{service_name=\"rcm-checkpointmgr\"}`

Labels:

- Label: `sessmgr_no`
Label Description: Sessmgr Number of UP
Example: 1
- Label: `up_address`
Label Description: IP address of UP
Example: 1.1.1.1
- Label: `up_mode`
Label Description: Mode in which UP is running
Example: active/standby

Appendix D: Metrics

- Label: `conn_state`
Label Description: Connection state of UP

Example: connected/disconnected

RCM configmgr UP count Category

`configmgr_upf_count`

Description: Current count of UPs in a particular host group in rcm configmgr Sample

Query: `configmgr_upf_count{service_name=\"rcm-configmgr\"}` Labels:

- Label: `host_grp_name`
Label Description: UP host group name

Example: any string

RCM configmgr config push complete count Category

`configmgr_cfg_push_complete_count`

Description: Count of config push complete in a particular group in rcm configmgr Sample

Query: `configmgr_cfg_push_complete_count{service_name=\"rcm-configmgr\"}`

Labels:

- Label: `host_grp_name`
Label Description: UP host group name

Example: any string

RCM configmgr config push failure count Category

`configmgr_cfg_push_failure_count`

Description: Count of config push failure in a particular host group in rcm configmgr Sample

Query: `configmgr_cfg_push_failure_count{service_name=\"rcm-configmgr\"}`

Appendix D: Metrics

Labels:

- Label: `host_grp_name`
Label Description: UP host group name
Example: any string

RCM configmgr switchover abort count Category

`configmgr_swover_abort_count`

Description: Count of switchover aborts in a particular host group in rcm configmgr Sample

Query: `configmgr_swover_abort_count{service_name=\"rcm-configmgr\"}` Labels:

- Label: `host_grp_name`
Label Description: UP host group name
Example: any string

RCM configmgr switchover failure count Category

`configmgr_swover_failure_count`

Description: Count of switchover failures in a particular host group in rcm configmgr Sample

Query: `configmgr_swover_failure_count{service_name=\"rcm-configmgr\"}`

Labels:

- Label: `host_grp_name`
Label Description: UP host group name
Example: any string

RCM controller BFD heartbeat failure count Category

`controller_bfd_hb_timeout_stats`

Description: Count of total BFD heartbeat timeout received by rcm controller Sample

Query: `controller_bfd_hb_timeout_stats{service_name=\"rcm-controller\"}`

RCM controller IPC received count Category

controller_ipc_rcvd_stats

Description: Count of total IPC message received by rcm controller

Sample Query: controller_ipc_rcvd_stats{service_name=\"rcm-controller\"} Labels:

- Label: pod_name
Label Description: Name of pod with which controller is communicating
Example: rcm-configmgr or rcm-chkptmgr

RCM controller IPC sent count Category

controller_ipc_sent_stats

Description: Count of total IPC message sent from rcm controller

Sample Query: controller_ipc_sent_stats{service_name=\"rcm-controller\"}

Labels:

- Label: pod_name
Label Description: Name of pod with which controller is communicating
Example: rcm-configmgr or rcm-chkptmgr

RCM controller IPC sent error count Category

controller_ipc_sent_error_stats

Description: Count of total IPC message sent error for rcm controller

Sample Query: controller_ipc_sent_error_stats{service_name=\"rcm-controller\"}

Labels:

- Label: pod_name
Label Description: Name of pod with which controller is communicating
Example: rcm-configmgr or rcm-chkptmgr

RCM controller UPF BFD event count Category

controller_upf_bfd_event_stats

Description: Count of total BFD events received by rcm controller

Sample Query: controller_upf_bfd_event_stats{service_name=\"rcm-controller\"}

Labels:

- Label: `grpId`
Label Description: Group ID of UPF
Example: any valid string
- Label: `endpoint`
Label Description: Endpoint address of UPF
Example: any ip address string
- Label: `event`
Label Description: Name of bfd event
Example: `bfd_up` or `bfd_down`

RCM controller UPF TCP connect count Category

controller_upf_tcp_connect_stats

Description: Count of total upf tcp connects received by rcm controller

Sample Query: controller_upf_tcp_connect_stats{service_name=\"rcm-controller\"}

Labels:

- Label: `grpId`
Label Description: Group ID of UPF
Example: any valid string
- Label: `endpoint`
Label Description: Endpoint address of UPF
Example: any ip address string

RCM controller UPF TCP disconnect count Category

controller_upf_tcp_disconnect_stats

Description: Count of total upf tcp disconnects received by rcm controller

Sample Query: controller_upf_tcp_disconnect_stats{service_name=\"rcm-controller\"} Labels:

- Label: grpId
Label Description: Group ID of UPF
Example: any valid string
- Label: endpoint
Label Description: Endpoint address of UPF
Example: any ip address string

RCM controller UPF boot timer expiry count Category

controller_upf_boot_timer_expiry_stats

Description: Count of total UPF boot timer expiry in rcm controller

Sample Query: controller_upf_boot_timer_expiry_stats{service_name=\"rcm-controller\"}

Labels:

- Label: endpoint
Label Description: Endpoint address of UPF
Example: any ip address string

RCM controller UPF msg received count Category

controller_upf_msg_rcvd_stats

Description: Count of total message from UPF received by rcm controller

Sample Query: controller_upf_msg_rcvd_stats{service_name=\"rcm-controller\"}

Labels:

- Label: grpId

Appendix D: Metrics

Label Description: Group ID of UPF

Example: any valid string

- Label: `endpoint`

Label Description: Endpoint address of UPF

Example: any ip address string

- Label: `msg_type`

Label Description: Name of msg sent/recvd

Example: `UpfMsgType_Registration`, `UpfMsgType_HB`, `UpfMsgType_State` etc

RCM controller UPF msg sent count Category

`controller_upf_msg_sent_stats`

Description: Count of total message sent to UPF by rcm controller

Sample Query: `controller_upf_msg_sent_stats{service_name=\"rcm-controller\"}Labels:`

- Label: `grpId`

Label Description: Group ID of UPF

Example: any valid string

- Label: `endpoint`

Label Description: Endpoint address of UPF

Example: any ip address string

- Label: `msg_type`

Label Description: Name of msg sent/recvd

Example: `UpfMsgType_Registration`, `UpfMsgType_HB`, `UpfMsgType_State` etc

RCM controller UPF registered count Category

`controller_upf_registered_stats`

Description: Count of total UPF registered in rcm controller

Sample Query: `controller_upf_registered_stats{service_name=\"rcm-controller\"}Labels:`

- Label: `grpId`

Appendix D: Metrics

Label Description: Group ID of UPF

Example: any valid string

- Label: `endpoint`

Label Description: Endpoint address of UPF

Example: any ip address string

RCM controller last switchover duration Category

`controller_last_switchover_seconds_total`

Description: Duration of last switchover completion in rcm controller

Sample Query: `controller_last_switchover_seconds_total{service_name=\"rcm-controller\"}`

RCM controller mass UPF failure count Category

`controller_mass_upf_failure_stats`

Description: Count of mass UPF failures in rcm controller

Sample Query: `controller_mass_upf_failure_stats{service_name=\"rcm-controller\"}`

RCM controller switchover count Category

`controller_switchover_stats`

Description: Count of total switchover in rcm controller

Sample Query: `controller_switchover_stats{service_name=\"rcm-controller\"}` Labels:

- Label: `swover_reason`

Label Description: Reason string for switchover

Example: BFD Failure, Planned Switchover etc

- Label: `state`

Label Description: State of switchover

Example: started or completed

RCM controller switchover failure count Category

controller_switchover_failure_stats

Description: Count of failed switchover in rcm controller

Sample Query: controller_switchover_failure_stats{service_name=\"rcm-controller\"}

Labels:

- Label: failure_reason

Label Description: Reason string for failure

Example: Unknown Destination Endpoint <> , Pre-switchover Failed, Notification of switchover Trigger to standby UP encountered error etc.

Example Expressions

The following is an example of an expression to get statistics of completed switchovers.

```
"targets": [
{
"expr": "sum (controller_switchover_stats{state=\"completed\"})", "interval":
"",
"legendFormat": "",
"refId": "A"
}
]
```

Whereas the following expression gives the total number of initiated switchovers:

```
"targets": [
{
"expr": "sum (controller_switchover_stats{state=\"started\"})", "interval": "",
"legendFormat": "",
"refId": "A"
}
]
```

The following expression gives the sum total of IPC sent to the controller for each pod, separately. That is, it displays two panels: First for IPC sent by ConfigMgr to the controller, and second for IPC sent by the CheckpointMgr to the controller:

```
"targets": [
{
"expr": "sum by (pod_name) (controller_ipc_sent_stats)", "interval": "",
```

Appendix D: Metrics

```
"legendFormat": "",  
"refId": "A"  
}
```

Appendix E: MIBs

The following is the information from *CISCO-RCM-MIB.my* file.

```
-- *****
-- CISCO-RCM-MIB.my
-- Copyright (c) 2020 by cisco Systems Inc.
-- All rights reserved.
-- *****
```

```
CISCO-RCM-MIB DEFINITIONS ::= BEGIN
```

```
IMPORTS
```

```
    MODULE-IDENTITY,
```

```
    OBJECT-TYPE,
```

```
    NOTIFICATION-TYPE
```

```
        FROM SNMPv2-SMI
```

```
    MODULE-COMPLIANCE,
```

```
    NOTIFICATION-GROUP,
```

```
    OBJECT-GROUP
```

```
        FROM SNMPv2-CONF
```

```
    TEXTUAL-CONVENTION,
```

```
    DateAndTime
```

```
        FROM SNMPv2-TC
```

```
    ciscoMgmt
```

```
        FROM CISCO-SMI;
```

```
ciscoRcmMIB MODULE-IDENTITY
```

```
    LAST-UPDATED      "202008120000Z"
```

```
    ORGANIZATION      "Cisco Systems, Inc."
```

Appendix E: MIBs

CONTACT-INFO

```
"Cisco Systems
Customer Service
Postal: 170 W Tasman Drive
San Jose, CA 95134
USA
Tel: +1 800 553-NETS"
```

DESCRIPTION

```
"The MIB module for the Cisco Redundancy Configuration Manager (RCM)
platform.
```

```
This MIB only handles notifications from the RCM."
```

```
REVISION "202008120000Z"
```

DESCRIPTION

```
"Added rcmFaultClusterName, rcmFaultNamespace, rcmFaultHostname
and rcmFaultInstance fields to identify the faults."
```

```
REVISION "201809190000Z"
```

DESCRIPTION

```
"Initial version of this MIB module."
```

```
::= { ciscoMgmt 1000}
```

```
-- Textual Conventions definition will be defined before this line
```

```
ciscoRcmMIBNotifs OBJECT IDENTIFIER
```

```
::= { ciscoRcmMIB 0 }
```

```
ciscoRcmMIBFaults OBJECT IDENTIFIER
```

```
::= { ciscoRcmMIB 1 }
```

ciscoRcmMIBConform OBJECT IDENTIFIER

::= { ciscoRcmMIB 2 }

rcmFaultId OBJECT-TYPE

SYNTAX OCTET STRING (SIZE (1..64))

MAX-ACCESS not-accessible

STATUS current

DESCRIPTION

"Uniquely identify the fault within a monitored entity."

::= { ciscoRcmMIBFaults 1 }

rcmFaultSource OBJECT-TYPE

SYNTAX OCTET STRING (SIZE (1..128))

MAX-ACCESS not-accessible

STATUS current

DESCRIPTION

"Uniquely identify the monitored entity

It can be a hostname or IP Address or

human readable identity."

::= { ciscoRcmMIBFaults 2 }

rcmFaultSeverity OBJECT-TYPE

SYNTAX OCTET STRING (SIZE (1..16))

MAX-ACCESS not-accessible

STATUS current

DESCRIPTION

"Indicates the level of urgency for operator attention

Appendix E: MIBs

Refer 3GPP TS32.111-5 v9.0.0 section 4.3."

```
::= { ciscoRcmMIBFaults 3 }
```

rcmFaultTime OBJECT-TYPE

```
SYNTAX          DateAndTime
MAX-ACCESS      not-accessible
STATUS          current
```

DESCRIPTION

"The date and time when the fault is detected."

```
::= { ciscoRcmMIBFaults 4 }
```

rcmFaultType OBJECT-TYPE

```
SYNTAX INTEGER {
    indeterminate(0),
    host-level(1),
    rcm-internal(2),
    userplane(3),
    pod-business-logic(4)
}
```

```
MAX-ACCESS      not-accessible
STATUS          current
```

DESCRIPTION

"Indicates the type of fault"

```
::= { ciscoRcmMIBFaults 5 }
```

rcmFaultAdditionalInfo OBJECT-TYPE

```
SYNTAX          OCTET STRING (SIZE (1..2048))
```

Appendix E: MIBs

MAX-ACCESS not-accessible

STATUS current

DESCRIPTION

"Additional Information about the fault."

::= { ciscoRcmMIBFaults 6 }

rcmFaultClusterName OBJECT-TYPE

SYNTAX OCTET STRING (SIZE (1..128))

MAX-ACCESS not-accessible

STATUS current

DESCRIPTION

"The cluster name associated to the fault."

::= { ciscoRcmMIBFaults 7 }

rcmFaultNamespace OBJECT-TYPE

SYNTAX OCTET STRING (SIZE (1..128))

MAX-ACCESS not-accessible

STATUS current

DESCRIPTION

"Identifies the namespace associated to the fault. This field is not always available for every fault."

::= { ciscoRcmMIBFaults 8 }

rcmFaultHostname OBJECT-TYPE

SYNTAX OCTET STRING (SIZE (1..128))

MAX-ACCESS not-accessible

STATUS current

Appendix E: MIBs

DESCRIPTION

"Identifies the hostname or ip address associated with the fault. This field is not always available for every fault."

```
::= { ciscoRcmMIBFaults 9 }
```

rcmFaultInstance OBJECT-TYPE

```
SYNTAX          OCTET STRING (SIZE (1..128))
```

```
MAX-ACCESS      not-accessible
```

```
STATUS          current
```

DESCRIPTION

"Identifies the instance associated to the fault. The instance is set by the alert rule creator and may not reference a host but could reference a process or KPI that is associated to the fault. This field is not always available for every fault"

```
::= { ciscoRcmMIBFaults 10 }
```

rcmVnfAlias OBJECT-TYPE

```
SYNTAX          OCTET STRING (SIZE (1..128))
```

```
MAX-ACCESS      not-accessible
```

```
STATUS          current
```

DESCRIPTION

"Alias for the monitored entity"

```
::= { ciscoRcmMIBFaults 11 }
```

```
-- Default Notification Type
```

```
rcmFaultActiveNotif NOTIFICATION-TYPE

OBJECTS          {

    rcmFaultId,

    rcmFaultSource,

    rcmFaultSeverity,

    rcmFaultTime,

    rcmFaultType,

    rcmFaultAdditionalInfo,

    rcmFaultClusterName,

    rcmFaultNamespace,

    rcmFaultHostname,

    rcmFaultInstance,

    rcmVnfAlias

}

STATUS          current

DESCRIPTION

    "This notification is generated by RCM

    whenever a fault gets triggered."

 ::= { ciscoRcmMIBNotifs 1 }
```

```
rcmFaultClearNotif NOTIFICATION-TYPE

OBJECTS          {

    rcmFaultId,

    rcmFaultSource,

    rcmFaultSeverity,

    rcmFaultTime,

    rcmFaultType,
```

```

        rcmFaultAdditionalInfo,
        rcmFaultClusterName,
        rcmFaultNamespace,
        rcmFaultHostname,
        rcmFaultInstance,
        rcmVnfAlias
    }

STATUS          current

DESCRIPTION

    "This notification is generated by RCM
    whenever a fault gets cleared."

 ::= { ciscoRcmMIBNotifs 2 }

rcmEventNotif NOTIFICATION-TYPE

OBJECTS        {
    rcmFaultId,
    rcmFaultSource,
    rcmFaultSeverity,
    rcmFaultTime,
    rcmFaultType,
    rcmFaultAdditionalInfo,
    rcmFaultClusterName,
    rcmFaultNamespace,
    rcmFaultHostname,
    rcmFaultInstance,
    rcmVnfAlias
}

```

Appendix E: MIBs

```
STATUS          current

DESCRIPTION

    "This notification is generated by RCM
    to notify a RCM event."

 ::= { ciscoRcmMIBNotifs 3 }

ciscoRcmMIBCompliances OBJECT IDENTIFIER

 ::= { ciscoRcmMIBConform 1 }

ciscoRcmMIBGroups OBJECT IDENTIFIER

 ::= { ciscoRcmMIBConform 2 }

rcmMIBCompliance MODULE-COMPLIANCE

STATUS          current

DESCRIPTION

    "The compliance statement for entities that support
    the Cisco RCM Managed Objects"

MODULE          -- this module

MANDATORY-GROUPS {

                rcmMIBFaultGroup,

                rcmMIBNotificationGroup

                }

 ::= { ciscoRcmMIBCompliances 1 }

-- Units of Conformance

rcmMIBFaultGroup OBJECT-GROUP
```

Appendix E: MIBs

```
OBJECTS          {
    rcmFaultId,
    rcmFaultSource,
    rcmFaultSeverity,
    rcmFaultTime,
    rcmFaultType,
    rcmFaultAdditionalInfo,
    rcmFaultClusterName,
    rcmFaultNamespace,
    rcmFaultHostname,
    rcmFaultInstance,
    rcmVnfAlias
}

STATUS          current

DESCRIPTION
    "The set of RCM Fault groups defined by this MIB"
 ::= { ciscoRcmMIBGroups 1 }

rcmMIBNotificationGroup NOTIFICATION-GROUP

NOTIFICATIONS   { rcmFaultActiveNotif,
                  rcmFaultClearNotif }

STATUS          current

DESCRIPTION
    "The set of RCM notifications defined by this MIB"
 ::= { ciscoRcmMIBGroups 2 }

END
```

Appendix F: P2P/ADC Plugin Configuration and Update Procedure

This section provides information about P2P/ADC Plugin configuration and update procedure.

The following steps are required in all the UPs.

1. Copy the patch to */flash* of all the UPs.

2. To patch the plugin, execute the following CLI command:

```
patch plugin p2p /flash/libp2p-<plugin_filename>
```

3. To install the plugin, execute the following CLI command:

```
install plugin p2p patch_libp2p-<plugin_filename>
```

4. Configure the P2P module and upgrade it through RCM for all the UPs (Active and Standby in one step):

```
configure
```

```
  plugin plugin_name
```

```
    module priority number version plugin_version
```

```
  end
```

```
update module plugin_name
```

To roll back the P2P/ADC plugin in all UPs, execute the following CLI command in Exec mode:

```
rollback module plugin_name
```

NOTES:

- You must load, patch, and install the plugin on all the UPs individually.
- Configurations in Step 4 is loaded in the RCM configuration file using the Modify script. For details, see [Modifying Host Configuration](#) section.
- Ensure to save the plugin at CP and UP.

Appendix G: RCM Configuration Generation Utility

This section provides sample Host configurations that is based on typical deployment setup, explanations of the configurations, usage, and script-help.

Important Note: The information captured in this section is solely for your reference.

Host Configurations

```
host Active1 <<<----Name of the host
svc-type upinterface <<<<----For interface-specific configuration, we need to use this svc-type
config
context EPC2
interface loop1_up1 loopback
ip address 192.0.2.1 255.255.255.0
#exit
interface loop2_up1 loopback
ip address 192.0.2.2 255.255.255.0
#exit
interface loop3_up1 loopback
ip address 192.0.2.3 255.255.255.0
#exit
interface loop4_up1 loopback
ip address 192.0.2.4 255.255.255.0
#exit
interface loop5_up1 loopback
ip address 192.0.2.5 255.255.255.0
#exit
#exit
end
svc-type sxsvc <<<<----For Sx service-specific configuration, we need to use this svc-type
config
context EPC2
sx-service sx_up1
instance-type userplane
bind ipv4-address 192.0.2.5
exit
#exit
```



```
end
svc-type upsvc <<<<----For UP service-specific configuration, we need to use this svc-type
config
context EPC2
user-plane-service up_up1
associate gtpu-service pgw-gtpu_up1 pgw-ingress
associate gtpu-service sgw-ingress-gtpu_up1 sgw-ingress
associate gtpu-service sgw-engress-gtpu_up1 sgw-egress
associate gtpu-service saegw-sxu_up1 cp-tunnel
associate sx-service sx_up1
associate fast-path service
associate control-plane-group g1
exit
#exit
#exit
end
svc-type gtpusvc <<<<----For GTPU service-specific configuration, we need to use this svc-type
config
context EPC2
gtpu-service pgw-gtpu_up1
bind ipv4-address 192.0.2.2
exit
gtpu-service saegw-sxu_up1
bind ipv4-address 192.0.2.3
exit
gtpu-service sgw-engress-gtpu_up1
bind ipv4-address 192.0.2.4
exit
gtpu-service sgw-ingress-gtpu_up1
bind ipv4-address 192.0.2.1
#exit
#exit
end
svc-type cpgrp <<<<----For CP group-specific configuration, we need to use this svc-type
config
control-plane-group g1
```

```
peer-node-id ipv4-address 192.0.3.1
exit
end
exit
```

NOTE: The script support for nrf service type currently does exist. So, you must manually configure this service type.

Script Help-string

```
~/Script/script_1302_02$ ./apply_config.sh
```

Usage: `./apply_config.sh` `[-g m i h n G]` `-f filename`

- `-g` : redundancy-group name
- `-m` : Append the starOS common/Host config to ops-center config
- `-i` : Input Common config file where starOS cli is present.
- `-h` : Input Host config file where starOS cli is present.
- `-n` : Input Namespace where ops-center is running.
- `-G` : Input Generation 4/5
 - For RCM VM version, input the value as 4. For RCM Cloud Native version, input the value as 5.

Applying both Common and Host-specific Configuration

```
~/Script/script_1302_02$ ./apply_config.sh -g 1 -G 5 -n smf -i
input/<path_name>/common_master.cli -h
<path_name1>/<path_name2>/host_master.cli
Validating....
Adding Commit Flag
Applying Clean Common Config
admin@10.0.0.1's password:
Commit complete.
Applying Clean Host Config
admin@10.0.0.1's password:
Commit complete.
```

Applying Common Configuration

```
~/Script/script_1302_02$ ./apply_config.sh -g 1 -G 5 -n smf -i
<path_name1>/<path_name2>/common_master.cli
Validating....
Adding Commit Flag
Applying Clean Common Config
```

```
admin@10.0.0.1's password:  
% No modifications to commit.
```

Applying Host-specific Configuration

```
~/Script/script_1302_02$ ./apply_config.sh -g 1 -G 5 -n smf -h  
<path_name1>/<path_name2>/host_master.cli  
Validating....  
Applying Clean Host Config  
admin@10.0.0.1's password:  
Commit complete.
```

Modifying Common Configuration

```
~/Script/script_1302_02$ ./apply_config.sh -g 1 -G 5 -n smf -m -i  
<path_name1>/<path_name2>/common_  
common_config_mod_2.cli common_config_mod.cli common_master.cli  
common_master_mod_2.cli common_master_mod.cli  
~/Script/script_1302_02$ ./apply_config.sh -g 1 -G 5 -n smf -m -i  
<path_name1>/<path_name2>/common_config_mod.cli  
Validating....  
Applying Modified Common Config  
admin@10.0.0.1's password:  
Commit complete.  
~/Script/script_1302_02$ ./apply_config.sh -g 1 -G 5 -n smf -m -i  
<path_name1>/<path_name2>/common_config_mod_2.cli  
Validating....  
Applying Modified Common Config  
admin@10.0.0.1's password:  
Commit complete.
```

Modifying Host Configuration

```
~/Script/script_1302_02$ ./apply_config.sh -g 1 -G 5 -n smf -m -h  
<path_name1>/<path_name2>/host_master_mod.cli  
Validating....  
preparing mod host config  
Applying Modified Host Config  
admin@10.0.0.1's password:  
Commit complete.
```

Appendix G: RCM Configuration Generation Utility

```
~/Script/script_1302_02$ ./apply_config.sh -g 1 -G 5 -n smf -m -h  
<path_name1>/<path_name2>/host_master_mod_2.cli
```

Validating....

preparing mod host config

Applying Modified Host Config

admin@10.0.0.1's password:

Commit complete.

Appendix H: RCM Deployment Known Issues

The following RCM deployment issue is seen in ESXI 6.7.0 with security patch ESXi-6.7.0-20210304001-standard.

RCA: k8s calico plugin fails to initialize on VMware deployment of the RCM VM.

Steps to Reproduce: VMware deployment of RCM VM

Fix Summary: Added the following MOP:

After the RCM VM deployment uses OVF, if the calico pods do not come up in 15-20 minutes, perform the following steps:

1. Configure the management IP and the default gateway. You can perform the same using net plan. Calico pods come up after this step.
2. Restart `init_cluster serice` - `systemctl restart init_cluster`. Ops-center pods come up.

THE SPECIFICATIONS AND INFORMATION REGARDING THE PRODUCTS IN THIS MANUAL ARE SUBJECT TO CHANGE WITHOUT NOTICE. ALL STATEMENTS, INFORMATION, AND RECOMMENDATIONS IN THIS MANUAL ARE BELIEVED TO BE ACCURATE BUT ARE PRESENTED WITHOUT WARRANTY OF ANY KIND, EXPRESS OR IMPLIED. USERS MUST TAKE FULL RESPONSIBILITY FOR THEIR APPLICATION OF ANY PRODUCTS.

THE SOFTWARE LICENSE AND LIMITED WARRANTY FOR THE ACCOMPANYING PRODUCT ARE SET FORTH IN THE INFORMATION PACKET THAT SHIPPED WITH THE PRODUCT AND ARE INCORPORATED HEREIN BY THIS REFERENCE. IF YOU ARE UNABLE TO LOCATE THE SOFTWARE LICENSE OR LIMITED WARRANTY, CONTACT YOUR CISCO REPRESENTATIVE FOR A COPY.

The Cisco implementation of TCP header compression is an adaptation of a program developed by the University of California, Berkeley (UCB) as part of UCB's public domain version of the UNIX operating system. All rights reserved. Copyright © 1981, Regents of the University of California.

NOTWITHSTANDING ANY OTHER WARRANTY HEREIN, ALL DOCUMENT FILES AND SOFTWARE OF THESE SUPPLIERS ARE PROVIDED "AS IS" WITH ALL FAULTS. CISCO AND THE ABOVE-NAMED SUPPLIERS DISCLAIM ALL WARRANTIES, EXPRESSED OR IMPLIED, INCLUDING, WITHOUT LIMITATION, THOSE OF MERCHANTABILITY, FITNESS FOR A PARTICULAR PURPOSE AND NONINFRINGEMENT OR ARISING FROM A COURSE OF DEALING, USAGE, OR TRADE PRACTICE.

IN NO EVENT SHALL CISCO OR ITS SUPPLIERS BE LIABLE FOR ANY INDIRECT, SPECIAL, CONSEQUENTIAL, OR INCIDENTAL DAMAGES, INCLUDING, WITHOUT LIMITATION, LOST PROFITS OR LOSS OR DAMAGE TO DATA ARISING OUT OF THE USE OR INABILITY TO USE THIS MANUAL, EVEN IF CISCO OR ITS SUPPLIERS HAVE BEEN ADVISED OF THE POSSIBILITY OF SUCH DAMAGES.

Any Internet Protocol (IP) addresses and phone numbers used in this document are not intended to be actual addresses and phone numbers. Any examples, command display output, network topology diagrams, and other figures included in the document are shown for illustrative purposes only. Any use of actual IP addresses or phone numbers in illustrative content is unintentional and coincidental.

All printed copies and duplicate soft copies are considered un-Controlled copies and the original on-line version should be referred to for latest version.

Cisco has more than 200 offices worldwide. Addresses, phone numbers, and fax numbers are listed on the Cisco website at www.cisco.com/go/offices.

Cisco and the Cisco logo are trademarks or registered trademarks of Cisco and/or its affiliates in the U.S. and other countries. To view a list of Cisco trademarks, go to this URL: www.cisco.com/go/trademarks. Third-party trademarks mentioned are the property of their respective owners. The use of the word partner does not imply a partnership relationship between Cisco and any other company. (1721R)

© 2024 Cisco Systems, Inc. All rights reserved.