



**System Amplifier and Line Extender
including GainMaker Products Trim
Networks**
Instructions







For Your Safety

Explanation of Warning and Caution Icons



Avoid personal injury and product damage! Do not proceed beyond any symbol until you fully understand the indicated conditions.

The following warning and caution icons alert you to important information about the safe operation of this product:

-  **You may find this symbol in the document that accompanies this product. This symbol indicates important operating or maintenance instructions.**
-  **You may find this symbol affixed to the product. This symbol indicates a live terminal where a dangerous voltage may be present; the tip of the flash points to the terminal device.**
-  **You may find this symbol affixed to the product. This symbol indicates a protective ground terminal.**
-  **You may find this symbol affixed to the product. This symbol indicates a chassis terminal (normally used for equipotential bonding).**
-  **You may find this symbol affixed to the product. This symbol warns of a potentially hot surface.**
-  **You may find this symbol affixed to the product and in this document. This symbol indicates an infrared laser that transmits intensity-modulated light and emits invisible laser radiation or an LED that transmits intensity-modulated light.**

Important

Please read this entire guide. If this guide provides installation or operation instructions, give particular attention to all safety statements included in this guide.

Notices

Trademark Acknowledgments

Cisco and the Cisco logo are trademarks or registered trademarks of Cisco and/or its affiliates in the U.S. and other countries. To view a list of cisco trademarks, go to this URL: www.cisco.com/go/trademarks.

Third party trademarks mentioned are the property of their respective owners.

The use of the word partner does not imply a partnership relationship between Cisco and any other company. (1110R)

Publication Disclaimer

Cisco Systems, Inc. assumes no responsibility for errors or omissions that may appear in this publication. We reserve the right to change this publication at any time without notice. This document is not to be construed as conferring by implication, estoppel, or otherwise any license or right under any copyright or patent, whether or not the use of any information in this document employs an invention claimed in any existing or later issued patent.

Copyright

© 2008, 2012 Cisco and/or its affiliates. All rights reserved. Printed in the United States of America.

Information in this publication is subject to change without notice. No part of this publication may be reproduced or transmitted in any form, by photocopy, microfilm, xerography, or any other means, or incorporated into any information retrieval system, electronic or mechanical, for any purpose, without the express permission of Cisco Systems, Inc.

Contents

Important Safety Instructions	v
Chapter 1	Introducing Trim Networks
Overview	1-1
Trim Facts.....	1-3
Types of Trim Networks	1-4
Trim Networks Naming Conventions	1-5
Trim Networks Part Numbers	1-6
Chapter 2	Installing Trim Networks
Overview	2-1
Illustrations of Trim Networks	2-2
Installing a Trim Network in a GMSA.....	2-9
Installing a Trim Network in a SAI, SAI+ & SAII	2-10
Installing a Trim Network in a SAI	2-12
Installing a Trim Network in a DA.....	2-14
Installing a Trim Network in a GMLE	2-16
Installing a Trim Network in a LEIII GaAs	2-18
Installing a Trim Network in a LEIII	2-20
Installing a Trim Network in a LEII	2-22
Installing a Trim Network in the LEI	2-24
Chapter 3	Frequency Response Plots
Overview	3-1
5-Pin Trim Networks Response Plots	3-2
GainMaker Trim Networks Response Plots.....	3-37
3-Pin Trim Networks Response Plots	3-50
Card Trim Networks Response Plots	3-55
Chapter 4	Customer Information
Glossary	Glossary-1
Index	Index-1

Important Safety Instructions

Read and Retain Instructions

Carefully read all safety and operating instructions before operating this equipment, and retain them for future reference.

Follow Instructions and Heed Warnings

Follow all operating and use instructions. Pay attention to all warnings and cautions in the operating instructions, as well as those that are affixed to this equipment.

Terminology

The terms defined below are used in this document. The definitions given are based on those found in safety standards.

Service Personnel - The term *service personnel* applies to trained and qualified individuals who are allowed to install, replace, or service electrical equipment. The service personnel are expected to use their experience and technical skills to avoid possible injury to themselves and others due to hazards that exist in service and restricted access areas.

User and Operator - The terms *user* and *operator* apply to persons other than service personnel.

Ground(ing) and Earth(ing) - The terms *ground(ing)* and *earth(ing)* are synonymous. This document uses *ground(ing)* for clarity, but it can be interpreted as having the same meaning as *earth(ing)*.

Electric Shock Hazard

This equipment meets applicable safety standards.



WARNING!

To reduce risk of electric shock, perform only the instructions that are included in the operating instructions. Refer all servicing to qualified service personnel only.

Electric shock can cause personal injury or even death. Avoid direct contact with dangerous voltages at all times. The protective ground connection, where provided, is essential to safe operation and must be verified before connecting the power supply.

Know the following safety warnings and guidelines:

- **Dangerous Voltages**
 - Only qualified service personnel are allowed to perform equipment installation or replacement.
 - Only qualified service personnel are allowed to remove chassis covers and access any of the components inside the chassis.
- **Grounding**
 - Do not violate the protective grounding by using an extension cable, power cable, or autotransformer without a protective ground conductor.
 - Take care to maintain the protective grounding of this equipment during service or repair and to re-establish the protective grounding before putting this equipment back into operation.

Important Safety Instructions, Continued

Installation Site

When selecting the installation site, comply with the following:

- **Protective Ground** - The protective ground lead of the building's electrical installation should comply with national and local requirements.
- **Environmental Condition** - The installation site should be dry, clean, and ventilated. Do not use this equipment where it could be at risk of contact with water. Ensure that this equipment is operated in an environment that meets the requirements as stated in this equipment's technical specifications, which may be found on this equipment's data sheet.

Installation Requirements



WARNING:

Allow only qualified service personnel to install this equipment. The installation must conform to all local codes and regulations.

Equipment Placement



WARNING:

Avoid personal injury and damage to this equipment. An unstable mounting surface may cause this equipment to fall.

To protect against equipment damage or injury to personnel, comply with the following:

- Install this equipment in a restricted access location.
- Do not install near any heat sources such as radiators, heat registers, stoves, or other equipment (including amplifiers) that produce heat.
- Place this equipment close enough to a mains AC outlet to accommodate the length of this equipment's power cord.
- Route all power cords so that people cannot walk on, place objects on, or lean objects against them. This may pinch or damage the power cords. Pay particular attention to power cords at plugs, outlets, and the points where the power cords exit this equipment.
- Use only with a cart, stand, tripod, bracket, or table specified by the manufacturer, or sold with this equipment.
- Make sure the mounting surface or rack is stable and can support the size and weight of this equipment.
- The mounting surface or rack should be appropriately anchored according to manufacturer's specifications. Ensure this equipment is securely fastened to the mounting surface or rack where necessary to protect against damage due to any disturbance and subsequent fall.

Ventilation

This equipment has openings for ventilation to protect it from overheating. To ensure equipment reliability and safe operation, do not block or cover any of the ventilation openings. Install the equipment in accordance with the manufacturer's instructions.

Important Safety Instructions, Continued

Rack Mounting Safety Precautions

Mechanical Loading

Make sure that the rack is placed on a stable surface. If the rack has stabilizing devices, install these stabilizing devices before mounting any equipment in the rack.



WARNING:

Avoid personal injury and damage to this equipment. Mounting this equipment in the rack should be such that a hazardous condition is not caused due to uneven mechanical loading.

Reduced Airflow

When mounting this equipment in the rack, do not obstruct the cooling airflow through the rack. Be sure to mount the blanking plates to cover unused rack space. Additional components such as combiners and net strips should be mounted at the back of the rack, so that the free airflow is not restricted.



CAUTION:

Installation of this equipment in a rack should be such that the amount of airflow required for safe operation of this equipment is not compromised.

Elevated Operating Ambient Temperature

Only install this equipment in a humidity- and temperature-controlled environment that meets the requirements given in this equipment's technical specifications.



CAUTION:

If installed in a closed or multi-unit rack assembly, the operating ambient temperature of the rack environment may be greater than room ambient temperature. Therefore, install this equipment in an environment compatible with the manufacturer's maximum rated ambient temperature.

Handling Precautions

When moving a cart that contains this equipment, check for any of the following possible hazards:



WARNING:



Avoid personal injury and damage to this equipment! Move any equipment and cart combination with care. Quick stops, excessive force, and uneven surfaces may cause this equipment and cart to overturn.

- Use caution when moving this equipment/cart combination to avoid injury from tip-over.

Important Safety Instructions, Continued

- If the cart does not move easily, this condition may indicate obstructions or cables that may need to be disconnected before moving this equipment to another location.
- Avoid quick stops and starts when moving the cart.
- Check for uneven floor surfaces such as cracks or cables and cords.

Grounding

This section provides instructions for verifying that the equipment is properly grounded.

Safety Plugs (USA Only)

This equipment is equipped with either a 3-terminal (grounding-type) safety plug or a 2-terminal (polarized) safety plug. The wide blade or the third terminal is provided for safety. Do not defeat the safety purpose of the grounding-type or polarized safety plug.

To properly ground this equipment, follow these safety guidelines:

- **Grounding-Type Plug** - For a 3-terminal plug (one terminal on this plug is a protective grounding pin), insert the plug into a grounded mains, 3-terminal outlet.
Note: This plug fits only one way. If this plug cannot be fully inserted into the outlet, contact an electrician to replace the obsolete 3-terminal outlet.
- **Polarized Plug** - For a 2-terminal plug (a polarized plug with one wide blade and one narrow blade), insert the plug into a polarized mains, 2-terminal outlet in which one socket is wider than the other.
Note: If this plug cannot be fully inserted into the outlet, try reversing the plug. If the plug still fails to fit, contact an electrician to replace the obsolete 2-terminal outlet.

Grounding Terminal

If this equipment is equipped with an external grounding terminal, attach one end of an 18-gauge wire (or larger) to the grounding terminal; then, attach the other end of the wire to a ground, such as a grounded equipment rack.

Safety Plugs (European Union)

- **Class I Mains Powered Equipment** – Provided with a 3-terminal AC inlet and requires connection to a 3-terminal mains supply outlet via a 3-terminal power cord for proper connection to the protective ground.
Note: The equipotential bonding terminal provided on some equipment is not designed to function as a protective ground connection.
- **Class II Mains Powered Equipment** – Provided with a 2-terminal AC inlet that may be connected by a 2-terminal power cord to the mains supply outlet. No connection to the protective ground is required as this class of equipment is provided with double or reinforced and/or supplementary insulation in addition to the basic insulation provided in Class I equipment.
Note: Class II equipment, which is subject to EN 50083-1, is provided with a chassis mounted equipotential bonding terminal. See the section titled **Equipotential Bonding** for connection instructions.

Important Safety Instructions, Continued

Equipotential Bonding

If this equipment is equipped with an external chassis terminal marked with the IEC 60417-5020 chassis icon () , the installer should refer to CENELEC standard EN 50083-1 or IEC standard IEC 60728-11 for correct equipotential bonding connection instructions.

AC Power

Important: If this equipment is a Class I equipment, it must be grounded.

- If this equipment plugs into an outlet, the outlet must be near this equipment, and must be easily accessible.
- Connect this equipment only to the power sources that are identified on the equipment-rating label normally located close to the power inlet connector(s).
- This equipment may have two power sources. Be sure to disconnect all power sources before working on this equipment.
- If this equipment **does not** have a main power switch, the power cord connector serves as the disconnect device.
- Always pull on the plug or the connector to disconnect a cable. Never pull on the cable itself.
- Unplug this equipment when unused for long periods of time.

Connection to -48 V DC/-60 V DC Power Sources

If this equipment is DC-powered, refer to the specific installation instructions in this manual or in companion manuals in this series for information on connecting this equipment to nominal -48 V DC/-60 V DC power sources.

Circuit Overload

Know the effects of circuit overloading before connecting this equipment to the power supply.



CAUTION:

Consider the connection of this equipment to the supply circuit and the effect that overloading of circuits might have on overcurrent protection and supply wiring. Refer to the information on the equipment-rating label when addressing this concern.

General Servicing Precautions



WARNING:

Avoid electric shock! Opening or removing this equipment's cover may expose you to dangerous voltages.

Be aware of the following general precautions and guidelines:

- **Servicing** - Refer all servicing to qualified service personnel. Servicing is required when this equipment has been damaged in any way, such as power supply cord or plug is damaged, liquid has been spilled or objects have fallen into this equipment, this equipment has been exposed to rain or moisture, does not operate normally, or has been dropped.

Important Safety Instructions, Continued

- **Wristwatch and Jewelry** - For personal safety and to avoid damage of this equipment during service and repair, do not wear electrically conducting objects such as a wristwatch or jewelry.
- **Lightning** - Do not work on this equipment, or connect or disconnect cables, during periods of lightning.
- **Labels** - Do not remove any warning labels. Replace damaged or illegible warning labels with new ones.
- **Covers** - Do not open the cover of this equipment and attempt service unless instructed to do so in the instructions. Refer all servicing to qualified service personnel only.
- **Moisture** - Do not allow moisture to enter this equipment.
- **Cleaning** - Use a damp cloth for cleaning.
- **Safety Checks** - After service, assemble this equipment and perform safety checks to ensure it is safe to use before putting it back into operation.

Electrostatic Discharge

Electrostatic discharge (ESD) results from the static electricity buildup on the human body and other objects. This static discharge can degrade components and cause failures.

Take the following precautions against electrostatic discharge:

- Use an anti-static bench mat and a wrist strap or ankle strap designed to safely ground ESD potentials through a resistive element.
- Keep components in their anti-static packaging until installed.
- Avoid touching electronic components when installing a module.

Fuse Replacement

To replace a fuse, comply with the following:

- Disconnect the power before changing fuses.
- Identify and clear the condition that caused the original fuse failure.
- Always use a fuse of the correct type and rating. The correct type and rating are indicated on this equipment.

Lithium Battery

For equipment with a lithium battery, observe the following rules:

- Do not dispose of used batteries through the regular garbage collection system, but follow the local regulations. The batteries may contain substances that could be harmful to the environment.
- Replace batteries with the same or equivalent type recommended by Cisco.
- Insert batteries correctly. There may be a risk of explosion if the batteries are incorrectly inserted.
- When disposing of this equipment, remove the batteries and dispose of them separately in accordance with local regulations.
- Do not recharge the batteries or expose them to temperatures above 100°C (212°F).

Important Safety Instructions, Continued

Electromagnetic Compatibility Regulatory Requirements

This equipment meets applicable electromagnetic compatibility (EMC) regulatory requirements. EMC performance is dependent upon the use of correctly shielded cables of good quality for all external connections, except the power source, when installing this equipment.

- Ensure compliance with cable/connector specifications and associated installation instructions where given elsewhere in this manual.

Otherwise, comply with the following good practices:

- Multi-conductor cables should be of single-braided, shielded type and have conductive connector bodies and backshells with cable clamps that are conductively bonded to the backshell and capable of making 360° connection to the cable shielding. Exceptions from this general rule will be clearly stated in the connector description for the excepted connector in question.
- Ethernet cables should be of single-shielded or double-shielded type.
- Coaxial cables should be of the double-braided shielded type.

EMC

Where this equipment is subject to USA FCC and/or Industry Canada rules, the following statements apply:

FCC Statement for Class A Equipment

This equipment has been tested and found to comply with the limits for a Class A digital device, pursuant to Part 15 of the FCC Rules. These limits are designed to provide reasonable protection against harmful interference when this equipment is operated in a commercial environment.

This equipment generates, uses, and can radiate radio frequency energy and, if not installed and used in accordance with the instruction manual, may cause harmful interference to radio communications. Operation of this equipment in a residential area is likely to cause harmful interference in which case users will be required to correct the interference at their own expense.

Industry Canada – Industrie Canadienne Statement

This apparatus complies with Canadian ICES-003.
Cet appareil est conforme à la norme NMB-003 du Canada.

CENELEC/CISPR Statement with Respect to Class A Information Technology Equipment

This is a Class A equipment. In a domestic environment this equipment may cause radio interference in which case the user may be required to take adequate measures.

Important Safety Instructions, Continued

Modifications

This equipment has been designed and tested to comply with applicable safety, laser safety, and EMC regulations, codes, and standards to ensure safe operation in its intended environment.

Do not make modifications to this equipment. Any changes or modifications could void the user's authority to operate this equipment.

Modifications have the potential to degrade the level of protection built into this equipment, putting people and property at risk of injury or damage. Those persons making any modifications expose themselves to the penalties arising from proven non-compliance with regulatory requirements and to civil litigation for compensation in respect of consequential damages or injury.

Accessories

Use only attachments or accessories specified by the manufacturer.

Chapter 1

Introducing Trim Networks

Overview

Introduction

The amplitude versus frequency response of an amplifier is defined as the variation in amplifier output level over frequency relative to a flat input. Trim networks are passive devices that compensate for amplitude/frequency variations by superimposing a response that is opposite to that of the uncompensated cascade.

The amount of variation over a cascade of amplifiers combined with the response of cable and passives make up the plant's response. The deviation from straight-line response varies depending on the system's age and the condition of the amplifier, cable, connectors, passives, etc. The sweeping process removes, to a great extent, this deviation from straight-line response.

Trim networks are tunable resistance/capacitance (R/C) or inductance/capacitance (L/C) circuits. Each one is designed to compensate for specific system anomalies. The two most common trim types are as follows:

- peak trim network
- dip trim network

A trim network allows you to adjust the amplifier's frequency response to be as uniform as possible across the entire output spectrum. The trim network can be adjusted (within limits) to cover a wide range of individual requirements. Type and use factor is determined by evaluating actual system frequency response.

Peak Trim Networks

Peak trim networks operate as broad bandwidth, tunable attenuators.

The peak trim appears to raise a dipped or rolled-off region to the same amplitude as the surrounding carriers resulting in a flat response. In reality, the trim network reduces the amplitude of the surrounding carriers while leaving the dipped or rolled-off region at the same level. The peak trim typically introduces 2 dB of flat loss. This is compensated for by reducing the input or interstage pad value.

Dip Trim Networks

Dip trim networks operate as narrow bandwidth, tunable attenuators.

The dip trim reduces the amplitude of a hump or peak to the same amplitude as the surrounding carriers. The dip trim typically introduces 1 dB to 2 dB of flat loss. This is compensated for by reducing the input or interstage pad value.

Overview, Continued

Chapter Contents

The following topics are included in this chapter.

Topic	See Page
Trim Facts	1-3
Types of Trim Networks	1-4
Trim Networks Naming Conventions	1-5
Trim Networks Part Numbers	1-6

Trim Facts

Trim Network Response Characteristics

Trim network response characteristics must be fully understood prior to commencing the sweep process. When selecting a trim, choose one that produces only the desired effect at one frequency. While tuning the trim network, observe the portions of bandwidth that appear flat. Ensure that no anomalies (peaks or dips) are introduced into unneeded areas.

Most trims have two controls. One control is a variable capacitor for frequency control and the other is a variable resistor for amplitude control.

Insertion Loss

Insertion loss must be considered when selecting a trim network. Insertion loss is an important consideration during the system design process, as the typical trim network reduces the amplifier gain by an average of 2 dB. If the amplifier is designed with minimum input, installing a trim network may not allow the amplifier to reach the proper RF output level.

Frequency Control

The variable capacitor (C1 in the frequency response plots) varies the frequency of the dip or peak. Depending on the design parameters of the trim network, the variable capacitor usually varies frequency 10 MHz to 100 MHz from nominal.

Amplitude Control

The variable resistor (R1 in the frequency response plots) varies the amplitude of the dip or peak and insertion loss. The typical variable resistor varies peak or dip amplitude between 1 dB and 3 dB.

Introducing a deeper dip increases the overall insertion loss. Likewise, introducing a higher peak increases the insertion loss.

Bench sweeping each trim allows the technician to gain a full understanding of the trim's operation. This can lead to reduced system downtime and increased productivity.

Types of Trim Networks

Trim Descriptions

There are five categories of trim networks that fit into the following equipment.

- GainMaker™ System Amplifier (GMSA)/GainMaker Line Extender (GMLE)
- Distribution Amplifier (DA)/
System Amplifier I, II, II+ and III (SAI, SAIL, SAII+ and SAIII)/
Line Extender III (LEIII)/
Line Extender III GaAs (LEIII GaAs)
- Line Extender II (LEII)
- Line Extender I (LEI)
- Trunk Amplifier

Pin Configurations

The following are the different trim network pin configurations.

Categories of Trim Networks	Description	Location
<ul style="list-style-type: none"> • GMSA • GMLE 	4 pins on the bottom of the board with installation guides	<ul style="list-style-type: none"> • SYS TRIM • SYS TRIM
<ul style="list-style-type: none"> • DA • SAI • SAIL • SAII+ • SAIII • LEIII • LEIII GaAs 	5 pins on the bottom of the board	<ul style="list-style-type: none"> • JUMPER OR TRIM PAD • TRIM • FWD TRIM/PAD • FWD TRIM/PAD • FWD TRIM/PAD • A5 • System Trim
LEII 750 MHz	5 pins on the bottom of the board	A4 TRIM OR PAD BOARD
LEII 550 MHz	3 pins on the bottom of the board	A4 TRIM OR PAD BOARD
LEI 550 MHz	a card (no pins)	INTERSTAGE NETWORK
Trunk Amplifier	3 pins on the bottom of the board	INTERSTAGE TRIM AT2

Trim Networks Naming Conventions

Introduction

Each trim network has been assigned a part number and descriptive title defining the operational characteristics of that particular network. The alphanumeric designation on the trim defines the network function. They are as follows:

- frequency
- insertion loss
- whether it has a pad socket
- which device it is intended to be used in
- whether it will affect the forward or reverse path

Example:

LSP-2SDF

where:

LSP = low single peak
 2 = 2 dB insertion loss
 S = pad socket
 D = DA/SA
 F = forward

Abbreviation Name Structures

The diagram below shows the abbreviated structure that Cisco has developed for selecting its trim network.

Frequency	Number of Peaks		Insertion Loss		Product	Path
L = Low	S = Single	D = Dip	1 = 1 dB	N = No Socket	T = Trunk	F = Forward
M = Mid	D = Double	P = Peak	2 = 2 dB	S = Socket	L = LEI	R = Reverse
H = High	T = Triple		3 = 3 dB		M = LEII 550	
U = Universal					D = DA/SA	
N = Narrow					N = LEII 750	
D = Diplexer					G = GainMaker	

Trim Networks Part Numbers

GainMaker, System Amplifier, Distribution Amplifier, Line Extender III, and Line Extender III GaAs Trim Networks Part Numbers

The following table lists the part numbers and model numbers for the GainMaker, System Amplifier, Distribution Amplifier, Line Extender III, and Line Extender III GaAs trim networks.

Part Number	Model Number	Description
506506	HSP-3SDF	High Frequency Single Peak
500221	MSD-2SDF	Mid. Frequency Single Dip
500300	MDP-3SDF	Mid. Frequency Dual Peak
276754	LDP-2SDF	Low Frequency Dual Peak
381101	MDP-2SDF	Mid. Frequency Dual Peak
381102	MSD-1SDF	Mid. Frequency Dip
501769	HSP-3NDF	High Frequency Single Peak
536640	HSP-3SDFL	High Frequency Single Peak with Low Pass Filter
536644	MSD-2SDFL	Mid. Frequency Single Dip with Low Pass Filter
712557	MSD-2NNL	Mid. Frequency Dual Peak
714446	MSD-1NGF	Mid. Frequency Dual Peak
4021964	HSP-1NGF	High Frequency Single Peak
4022212	MSD-1NGF	High Frequency Dual Peak

Trim Networks Part Numbers, Continued

Line Extender II and I Trim Networks Part Numbers

The following table lists the part numbers and model numbers for the Line Extender II and I trim networks.

Part Number	Model Number	Description	Module
541635	HSP-2NNF	High Frequency Single Peak	750 LEII
541636	MSD-2NNF	Mid. Frequency Single Dip	750 LEII
541637	LDP-2NNF	Low/High Frequency Peak	750 LEII
544125*	HSP-2NNF W/HPF	High Frequency Single Peak with High Pass Filter	750 LEII
544126*	MSD-2NNF W/HPF	Mid. Frequency Single Dip with High Pass Filter	750 LEII
544127*	LDP-2NNF W/HPF	Low Frequency Dual Peak with High Pass Filter	750 LEII
501967	LDP-2SMF	Low Frequency Dual Peak	550 LEII
502273	MDP-3SMF	Mid. Frequency Dip/Peak	550 LEII
372728	LDP-2SLF	Low Frequency Dual Peak	550 LEI

* Unique for 5-40 upgrade of 5-30 750 MHz Line Extender II.

Jumper Boards Part Numbers

The following table lists the part numbers for jumper boards.

Part Number	Module
589285	GMSA/ GMLE
466052	Trunk Amplifier Pad 1S
501326	DA/ SAI/ SAII/ SAII+/ SAIII/ LEIII
379986	LEII 550 MHz
081630	LEII 750 MHz
149666	LEI 550 MHz

Chapter 2

Installing Trim Networks

Overview

Introduction

This chapter describes the procedure to follow when installing the trim network in a GainMaker System Amplifier (GMSA), GainMaker Line Extender (GMLE), System Amplifier (SA), Distribution Amplifier (DA), Line Extender I (LEI), Line Extender II (LEII), Line Extender III (LEIII), and Line Extender III GaAs (LEIII GaAs).

Chapter Contents

The following topics are included in this chapter.

Topic	See Page
Illustrations of Trim Networks	2-2
Installing a Trim Network in a GMSA	2-9
Installing a Trim Network in a SAII, SAII+& SAIII	2-10
Installing a Trim Network in a SAI	2-12
Installing a Trim Network in a DA	2-14
Installing a Trim Network in a GMLE	2-16
Installing a Trim Network in a LEIII GaAS	2-18
Installing a Trim Network in a LEIII	2-20
Installing a Trim Network in a LEII	2-22
Installing a Trim Network in a LEI	2-24

Illustrations of Trim Networks

GM, SA, DA, LEII, and LEIII GaAs Trim Network Illustrations

The following table contains illustrations of the various trim networks used in GM, SA, DA, LEII, and LEIII GaAs.

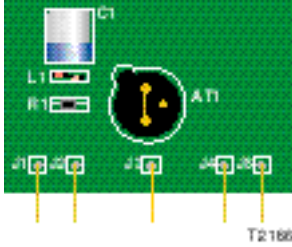
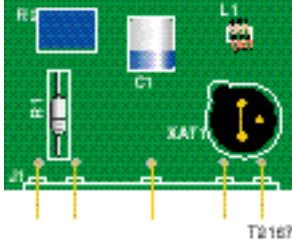
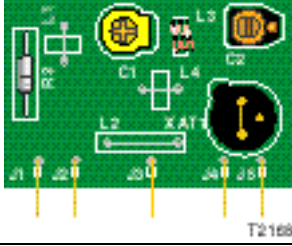
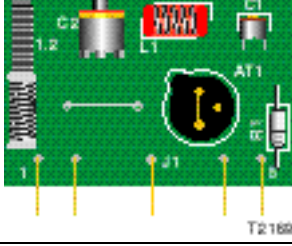
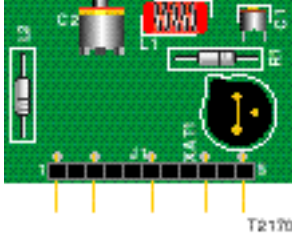
Part and Model Number	Description	Diagram of Trim
506506 HSP-3SDF	High Frequency Single Peak	
500221 MSD-2SDF	Mid. Frequency Single Dip	
500300 MDP-3SDF	Mid. Frequency Dual Peak	
276754 LDP-2SDF	Low Frequency Dual Peak	
381101 MDP-2SDF	Mid. Frequency Dual Peak	

Illustrations of Trim Networks, Continued

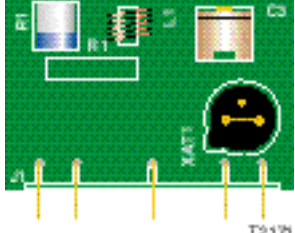
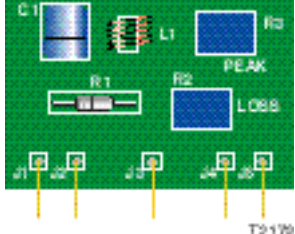
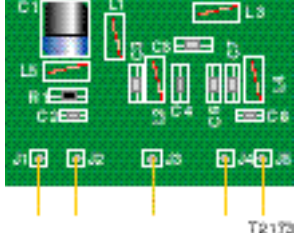
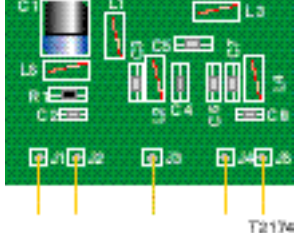
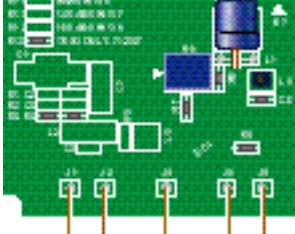
<p>381102 MDP-1SDF</p>	<p>Mid. Frequency Dip</p>	
<p>501769 HSP-3NDF</p>	<p>High Frequency Single Peak</p>	
<p>536640 HSP-3SDFL</p>	<p>High Frequency Single Peak with Low Pass Filter</p>	
<p>536644 MSD-2SDFL</p>	<p>Mid. Frequency Single Dip with Low Pass Filter</p>	
<p>712557 MSD-2NNF</p>	<p>Mid. Frequency Dual Peak</p>	

Illustrations of Trim Networks, Continued

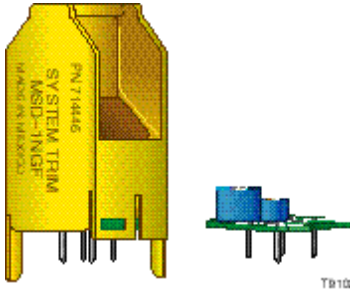
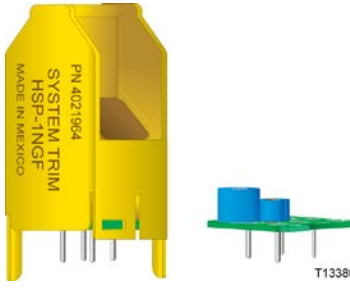
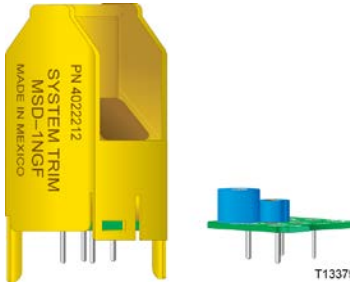
<p>714446 MSD-1NGF</p>	<p>Mid. Frequency Dual Peak</p>	
<p>4021964</p>	<p>High Frequency Single Peak</p>	
<p>4022212</p>	<p>High Frequency Dual Peak</p>	

Illustrations of Trim Networks, Continued

750 MHz Line Extender II Trim Network Illustrations

The following table contains illustrations of the various 750 MHz Line Extender II trim networks.

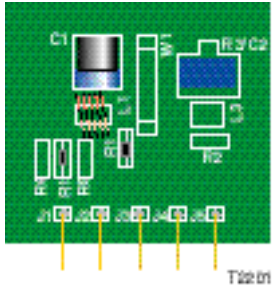
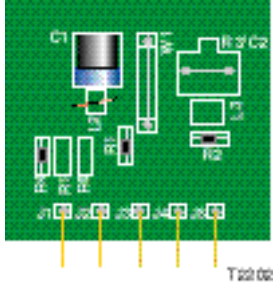
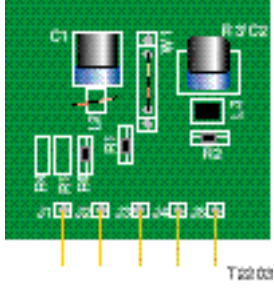
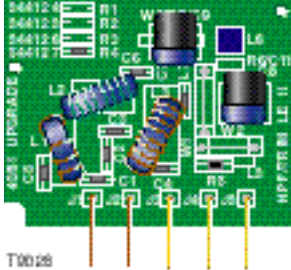
Part and Model Number	Description	Illustration of Trim
541635 HSP-2NNF	High Frequency Single Peak	
541636 MSD-2NNF	Mid. Frequency Single Dip	
541637 LDP-2NNF	Low/High Frequency Peak	
544125* HSP-2NNF W/HPF	High Frequency Single Peak with High Pass Filter	

Illustrations of Trim Networks, Continued

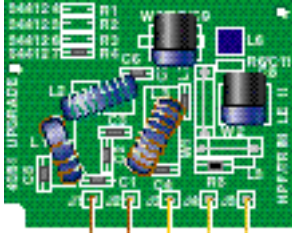
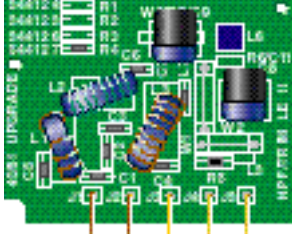
<p>544126* MSD-2NNF W/HPF</p>	<p>Mid. Frequency Single Dip with High Pass Filter</p>	 <p>The image shows a green PCB layout for the 544126* MSD-2NNF W/HPF. It features a central transformer (W) and a high-pass filter (HPF) section. Components include resistors (R1, R2, R3, R4, R5, R6, R7, R8, R9, R10, R11, R12, R13, R14, R15, R16, R17, R18, R19, R20, R21, R22, R23, R24, R25, R26, R27, R28, R29, R30, R31, R32, R33, R34, R35, R36, R37, R38, R39, R40, R41, R42, R43, R44, R45, R46, R47, R48, R49, R50, R51, R52, R53, R54, R55, R56, R57, R58, R59, R60, R61, R62, R63, R64, R65, R66, R67, R68, R69, R70, R71, R72, R73, R74, R75, R76, R77, R78, R79, R80, R81, R82, R83, R84, R85, R86, R87, R88, R89, R90, R91, R92, R93, R94, R95, R96, R97, R98, R99, R100), capacitors (C1, C2, C3, C4, C5, C6, C7, C8, C9, C10, C11, C12, C13, C14, C15, C16, C17, C18, C19, C20, C21, C22, C23, C24, C25, C26, C27, C28, C29, C30, C31, C32, C33, C34, C35, C36, C37, C38, C39, C40, C41, C42, C43, C44, C45, C46, C47, C48, C49, C50, C51, C52, C53, C54, C55, C56, C57, C58, C59, C60, C61, C62, C63, C64, C65, C66, C67, C68, C69, C70, C71, C72, C73, C74, C75, C76, C77, C78, C79, C80, C81, C82, C83, C84, C85, C86, C87, C88, C89, C90, C91, C92, C93, C94, C95, C96, C97, C98, C99, C100), inductors (L1, L2, L3, L4, L5, L6, L7, L8, L9, L10, L11, L12, L13, L14, L15, L16, L17, L18, L19, L20, L21, L22, L23, L24, L25, L26, L27, L28, L29, L30, L31, L32, L33, L34, L35, L36, L37, L38, L39, L40, L41, L42, L43, L44, L45, L46, L47, L48, L49, L50, L51, L52, L53, L54, L55, L56, L57, L58, L59, L60, L61, L62, L63, L64, L65, L66, L67, L68, L69, L70, L71, L72, L73, L74, L75, L76, L77, L78, L79, L80, L81, L82, L83, L84, L85, L86, L87, L88, L89, L90, L91, L92, L93, L94, L95, L96, L97, L98, L99, L100), and a transformer (W). The PCB is labeled with '4581 UPGRADE' and 'HPF/TE BI LE II'. The part number '544126*' is printed on the board. The board is shown with four gold wire bonds at the bottom.</p>
<p>544127* LDP-2NNF W/HPF</p>	<p>Low Frequency Dual Peak with High Pass Filter</p>	 <p>The image shows a green PCB layout for the 544127* LDP-2NNF W/HPF. It features a central transformer (W) and a high-pass filter (HPF) section. Components include resistors (R1, R2, R3, R4, R5, R6, R7, R8, R9, R10, R11, R12, R13, R14, R15, R16, R17, R18, R19, R20, R21, R22, R23, R24, R25, R26, R27, R28, R29, R30, R31, R32, R33, R34, R35, R36, R37, R38, R39, R40, R41, R42, R43, R44, R45, R46, R47, R48, R49, R50, R51, R52, R53, R54, R55, R56, R57, R58, R59, R60, R61, R62, R63, R64, R65, R66, R67, R68, R69, R70, R71, R72, R73, R74, R75, R76, R77, R78, R79, R80, R81, R82, R83, R84, R85, R86, R87, R88, R89, R90, R91, R92, R93, R94, R95, R96, R97, R98, R99, R100), capacitors (C1, C2, C3, C4, C5, C6, C7, C8, C9, C10, C11, C12, C13, C14, C15, C16, C17, C18, C19, C20, C21, C22, C23, C24, C25, C26, C27, C28, C29, C30, C31, C32, C33, C34, C35, C36, C37, C38, C39, C40, C41, C42, C43, C44, C45, C46, C47, C48, C49, C50, C51, C52, C53, C54, C55, C56, C57, C58, C59, C60, C61, C62, C63, C64, C65, C66, C67, C68, C69, C70, C71, C72, C73, C74, C75, C76, C77, C78, C79, C80, C81, C82, C83, C84, C85, C86, C87, C88, C89, C90, C91, C92, C93, C94, C95, C96, C97, C98, C99, C100), inductors (L1, L2, L3, L4, L5, L6, L7, L8, L9, L10, L11, L12, L13, L14, L15, L16, L17, L18, L19, L20, L21, L22, L23, L24, L25, L26, L27, L28, L29, L30, L31, L32, L33, L34, L35, L36, L37, L38, L39, L40, L41, L42, L43, L44, L45, L46, L47, L48, L49, L50, L51, L52, L53, L54, L55, L56, L57, L58, L59, L60, L61, L62, L63, L64, L65, L66, L67, L68, L69, L70, L71, L72, L73, L74, L75, L76, L77, L78, L79, L80, L81, L82, L83, L84, L85, L86, L87, L88, L89, L90, L91, L92, L93, L94, L95, L96, L97, L98, L99, L100), and a transformer (W). The PCB is labeled with '4581 UPGRADE' and 'HPF/TE BI LE II'. The part number '544127*' is printed on the board. The board is shown with four gold wire bonds at the bottom.</p>

* Unique for 5-40 upgrade of 5-30 750 MHz Line Extender II.

Illustrations of Trim Networks, Continued

550 MHz Line Extender II Trim Network Illustrations

The following table contains illustrations of the various 550 MHz Line Extender II trim networks.

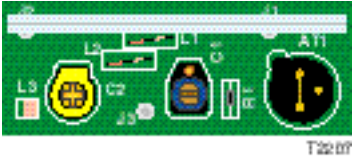
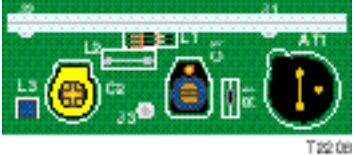
Part and Model Number	Description	Illustration of Trim
501967 LDP-2SMF	Low Frequency Dual Peak	
502273 MDP-3SMF	Mid. Frequency Dip/Peak	

Illustrations of Trim Networks, Continued

550 MHz Line Extender I Trim Network Illustrations

The following table shows an illustration of the 550 MHz Line Extender I trim network.

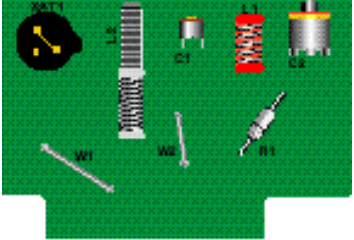
Part and Model Number	Description	Illustration of Trim
372728 LDP-2SLF	Low Frequency Dual Peak	

Installing a Trim Network in a GMSA

Procedure

Follow the procedures below to install a trim network in a GainMaker System Amplifier (GMSA) module.

1. Open the GMSA housing.
2. Switch the AGC to **THERMAL**.
3. Record the RF output levels.

Note: The trim network location is labeled **SYS TRIM** on the module cover. Refer to the illustration below.

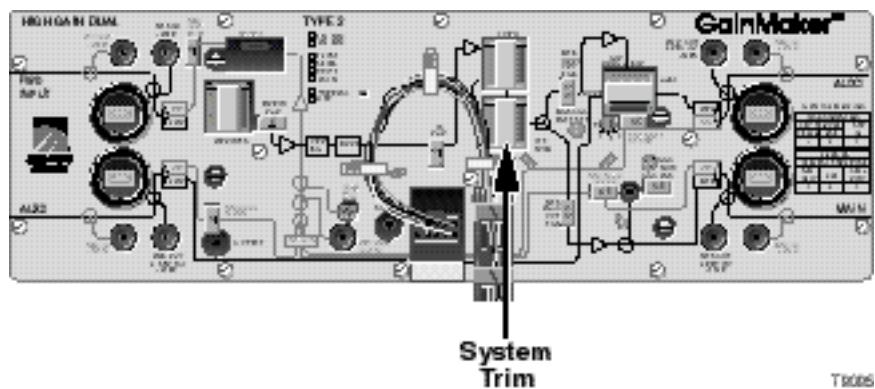

4. Remove jumper from system trim location.
5. Install the trim network into the system trim slot.

Notes:

- Be sure all the pins on the system trim bottom align with the pin holes in the system trim slot, allowing the system trim to install flat against the amplifier module.
 - Make sure the components face the outside of the station (See diagram above for proper positioning).
6. After tuning the trim network for the proper response, measure the RF output level.
 7. Change the interstage pad or input pad to obtain the same RF output level as noted in step 3.
 8. Switch the AGC module to **AUTO**.
 9. Reset the AGC for proper output levels.
 10. Close the GMSA housing.

Installing a Trim Network in a SAI, SAI+ & SAIII

Procedure

Follow the procedure to install a trim network in a System Amplifier II, II+ or III (SAI, SAI+ SAIII) module.

1. Open the SAI, SAI+ or SAIII housing.
2. Open the SAI, SAI+ or SAIII module cover.
3. Switch the AGC to **THERMAL**.
4. Record the RF output levels.

Note: The trim network location is labeled **FWD TRIM/PAD** on the printed circuit board.



5. Using a wire cutter or snips, carefully cut the bus wire jumper as close to the circuit board as possible.
6. Remove the jumper wire from the module using needle-nose pliers.
Note: Do not let the loose cutting fall into the amplifier.
7. Ensure the pins are straight and clean on the trim network.
8. Insert the trim network into the **FWD TRIM/PAD** socket.

Be sure all the pins on the trim network bottom align with the pin holes in the FWD TRIM/PAD socket, allowing the trim network to install flat against the module.

Installing a Trim Network in a SAI, SAI+ & SAIII, Continued

9. After tuning the trim network for the proper response, measure the RF output level.
10. Change the interstage pad or input pad to obtain the same RF output level as noted in step 4.
11. Switch the AGC to **AUTO**.
12. Reset the AGC for proper output levels.
13. Close the SAI, SAI+ or SAIII module cover.
14. Close the housing.

Note: If the trim network is removed, either install a plug-in jumper (part number 501326) or solder a 22 AWG bus wire in the FWD TRIM/PAD location.

Installing a Trim Network in a SAI

Procedure

Follow the procedure to install a trim network in a SAI module.

1. Open the SAI housing.
2. Open the SAI module cover.
3. Switch the ACM to **THERMAL**.
4. Record the RF output levels.

Note: The trim network location is labeled **TRIM** on the printed circuit board.

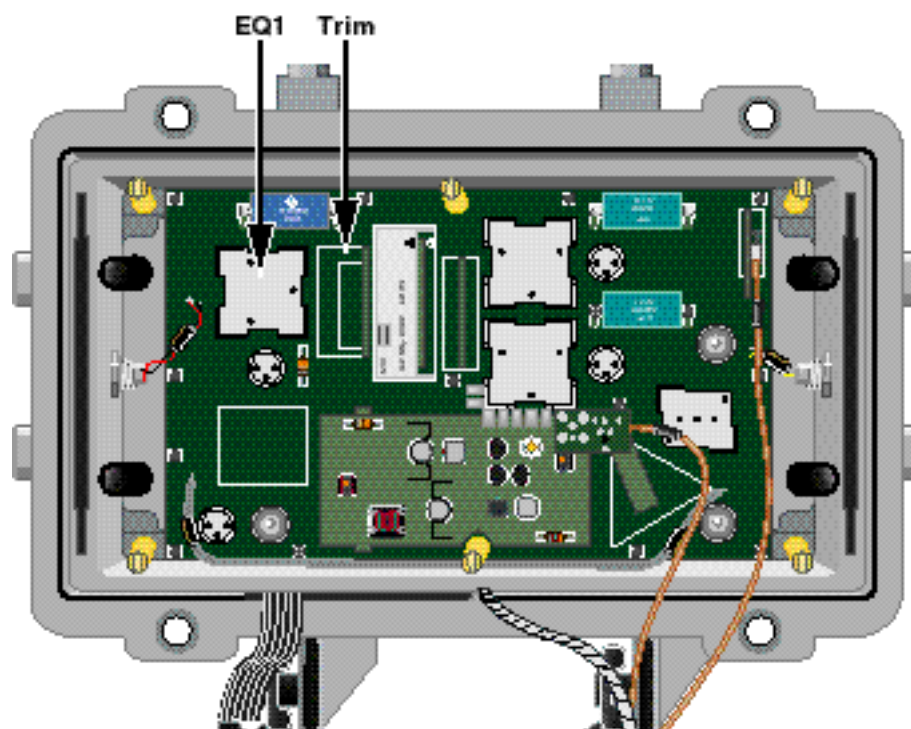

T2216

5. Pull the plug-in jumper from the module.

Installing a Trim Network in a SAI, Continued

6. Ensure the pins are straight and clean on the trim network.
7. Insert the trim network into the **TRIM** sockets, with the body of the trim network facing the input equalizer (EQ1).

Be sure all the pins on the trim network bottom align with the pin holes in the TRIM socket, allowing the trim network to install flat against the module.
8. After tuning the trim network for the proper frequency response, measure the RF output level.
9. Change the interstage pad or the input pad to obtain the same RF output level as noted in step 4.
10. Switch the AGC to **AUTO**.
11. Reset the ACM for proper output levels.
12. Close the SAI module cover.
13. Close the SAI housing.

Note: If the trim network is removed, replace the plug-in jumper (part number 501326) in the TRIM location.

Installing a Trim Network in a DA

Procedure

Follow the procedure to install a trim network in a DA module.

1. Open the DA housing.
2. Open the DA module cover.
3. Switch the ACM/AGC to **THERMAL**.
4. Record the RF output levels.
5. Pull the plug-in jumper from the DA module.

Note: The trim network location is labeled **JUMPER OR TRIM PAD** on the printed circuit board.

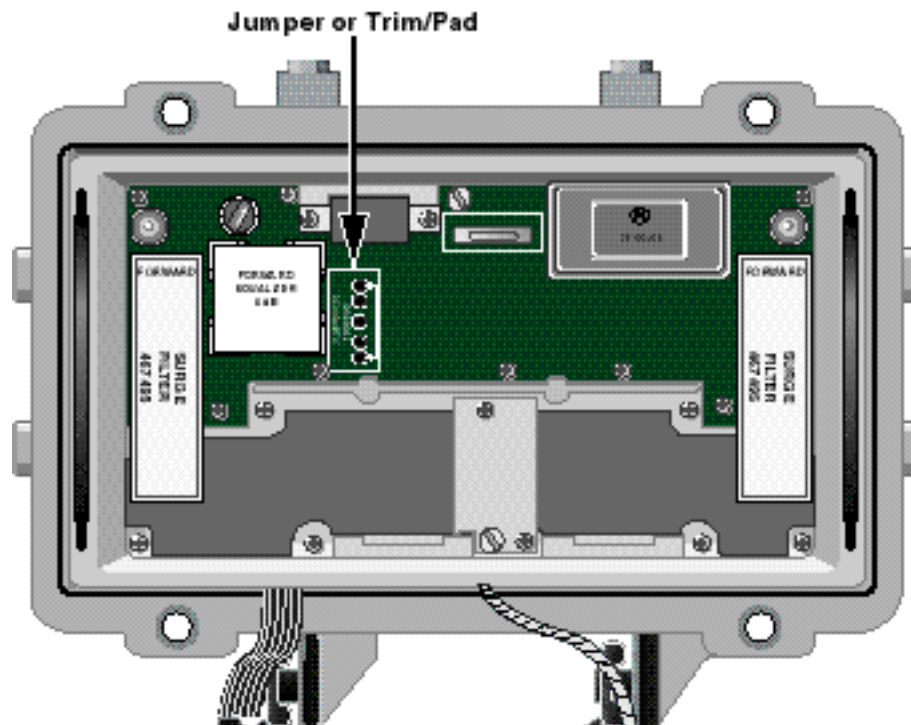

T2213

Installing a Trim Network in a DA, Continued

6. Ensure the pins are straight and clean on the trim network.
7. Insert the trim network into **JUMPER OR TRIM PAD** socket.
Be sure all the pins on the trim network bottom align with the pin holes in the JUMPER OR TRIM PAD socket, allowing the trim network to install flat against the module.
8. After tuning the trim network for the proper response, measure the RF output level.
9. Change the interstage pad or input pad to obtain the same RF output level as noted in step 4.
10. Switch the AGC module to **AUTO**.
11. Reset the AGC for proper output levels.
12. Close the DA module cover.
13. Close the DA housing.

Note: If the trim network is removed, replace the plug-in jumper (part number 501326) in the JUMPER OR TRIM PAD location.

Installing a Trim Network in a GMLE

Procedure

Follow the procedures below to install a trim network in a GMLE module.

1. Open the GMLE housing.
2. Switch the AGC to **THERMAL**.
3. Record the RF output levels.

Note: The trim network is labeled **SYS TRIM** on the module cover. Refer to the illustration below.

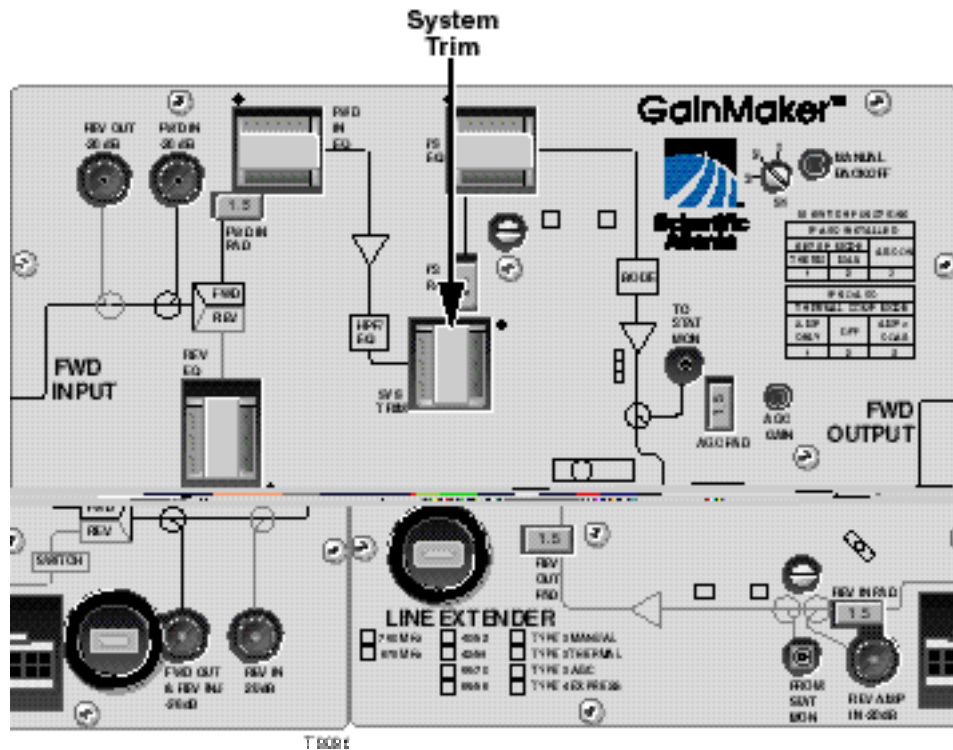

Installing a Trim Network in a GMLE, Continued

4. Remove the jumper from the system trim location.
5. Install the trim network into the system trim slot.

Notes:

- Be sure all the pins on the system trim bottom align with the pin holes in the system trim slot, allowing the system trim to install flat against the amplifier module.
 - Make sure the components face the outside of the station (See diagram above for proper positioning).
6. After tuning the trim network for the proper response, measure the RF output level.
 7. Change the interstage pad or input pad to obtain the same RF output level as noted in step 3.
 8. Switch the AGC module to **AUTO**.
 9. Reset the AGC for proper output levels.
 10. Close the GMLE housing.

Installing a Trim Network in a LEIII GaAs

Procedure

Follow the procedure to install a trim network in an LEIII GaAs module.

1. Open the LEIII GaAs housing.
2. Open the LEIII GaAs module cover.
3. Switch the AGC to **THERMAL**.
4. Record the output levels.
5. Select a system trim that has a frequency response opposite to that of the measured system response. This produces a net effect closer to a flat response.
6. Using a wire cutter or snips, carefully cut the jumper **W1** from the system trim location.



7. Remove the jumper wire from the module using needle-nose pliers.
Do not let the loose cutting fall into the module.
8. Ensure the pins are straight and clean on the trim network.
9. Insert the trim network in the trim network socket.

Note: Be sure all the pins on the system trim bottom align with the pin holes in the system trim slot, allowing the system trim to install flat against the module.

Installing a Trim Network in a LEIII GaAs, Continued

10. Adjust the trim network to produce the flattest frequency response.
11. Using the sweep receiver or spectrum analyzer, check the module output level and the tilt.
12. Reset the output tilt and/or level if necessary.
13. If the LEIII has an AGC module installed...
 - Set the Auto/Thermal switch on the AGC module to **AUTO**, and
 - Adjust R2 on the AGC module to match the output level measured in THERMAL mode.
14. Close the LEIII GaAs module cover.
15. Close the LEIII GaAS housing.

Note: If the trim network is removed, replace the plug-in jumper (part number 501326) in the W1 location.

Installing a Trim Network in a LEIII

Procedure

Follow the procedure to install a trim network in an LEIII module.

1. Open the LEIII housing.
2. Open the LEIII module cover.
3. If equipped with AGC, switch the AGC to **THERMAL**.
4. Record the RF output levels.

Note: The trim network location is labeled **SYS TRIM** on the printed circuit board.

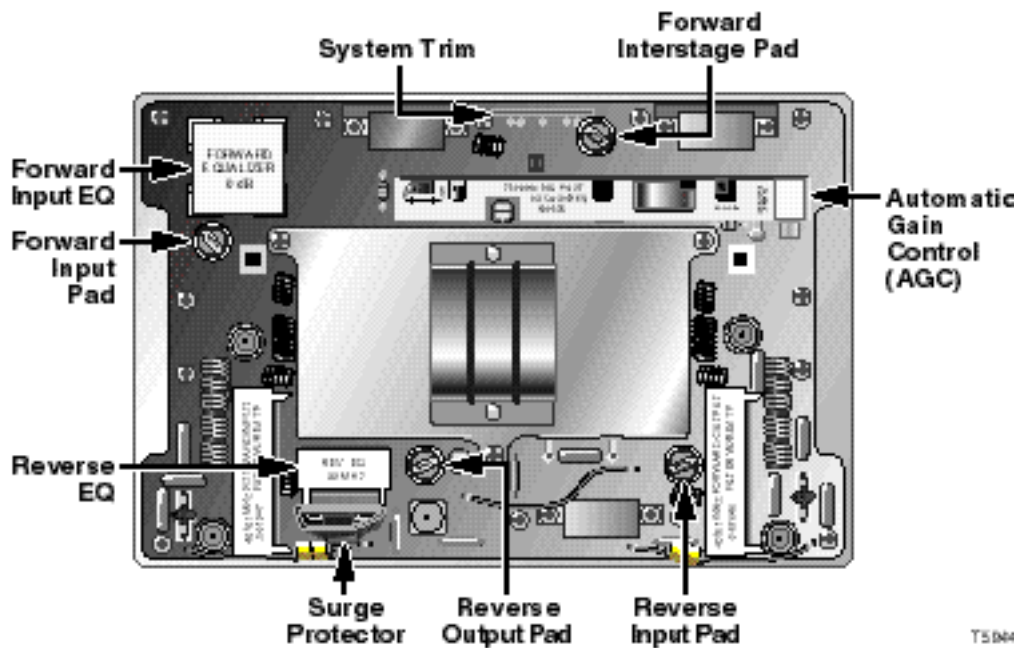

5. Using a wire cutter or snips, carefully cut the bus wire jumper as close to the circuit board as possible.
6. Remove the jumper wire from the module using needle-nose pliers.
Do not let the loose cutting fall into the amplifier.
7. Ensure the pins are straight and clean on the trim network.

Installing a Trim Network in a LEIII, Continued

8. Insert the trim network into the **A5** sockets.
9. After tuning the trim network for the proper response, measure the RF output level.
10. Change the interstage pad or input pad to obtain the same RF output level as noted in step 4.
11. Switch the AGC module to **AUTO** if so equipped.
12. Close the LEIII module cover.
13. Close the LEIII housing.

Note: If the trim network is removed, replace the plug-in jumper (part number 501326) or solder a 22 AWG bus wire in the A5 location.

Installing a Trim Network in a LEII

Procedure

Follow the procedure to install a trim network in an LEII module.

1. Open the LEII housing.
2. Open the LEII module cover.
3. If the station is operating in the automatic mode, set the AUTO/THERMAL switch on the automatic gain control (AGC) to **THERMAL**.
4. Record the RF output levels.

Note: The trim network location is labeled **A4 TRIM OR PAD BOARD** on the printed circuit board.

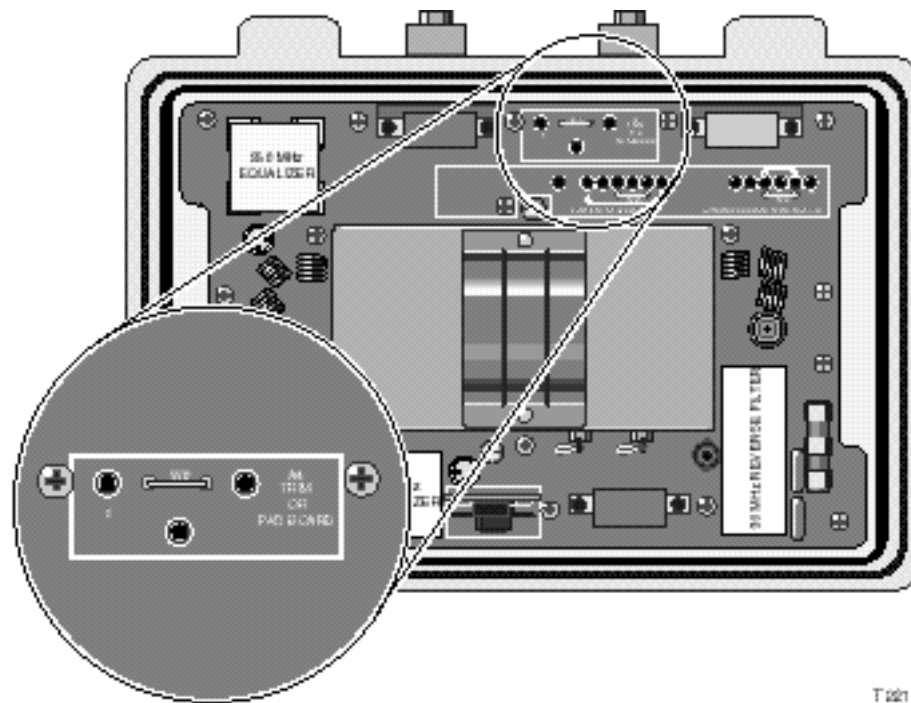

T2214

Installing a Trim Network in a LEII, Continued

5. Using a wire cutter or snips, carefully cut the wire jumper (**W8**) on the module's midstage section (**A4**) as close to the circuit board as possible.
6. Remove the wire jumper from the module using needle-nose pliers.
Do not let loose cutting fall into the amplifier.
7. Ensure the pins are straight and clean on the trim network.
8. After tuning the trim network for the proper response, measure the RF output level.
9. Change the interstage pad or input pad to obtain the same RF output level as noted in step 4.
10. If the station is operating in the automatic mode, set the AUTO/THERMAL switch on the AGC to **AUTO**.
11. Reset the AGC for proper output levels.
12. Close the LEII module cover.
13. Close the LEII housing.

Note: If the trim network is removed, either install a plug-in jumper (part number 379986 for 550 MHz or 081630 for 750 MHz) or solder a 22 AWG bus wire in the A4 location.

Installing a Trim Network in the LEI

Procedure

The LEI has a midstage card-type receptacle where a jumper, trim network, or thermal can reside. Follow the procedure to install a trim network in an LEI module.

1. Open the LEI housing.
2. Open the LEI module cover.
3. Record the RF output levels.
4. Remove the thermal or jumper.

Note: This location is labeled **INTERSTAGE NETWORK**.

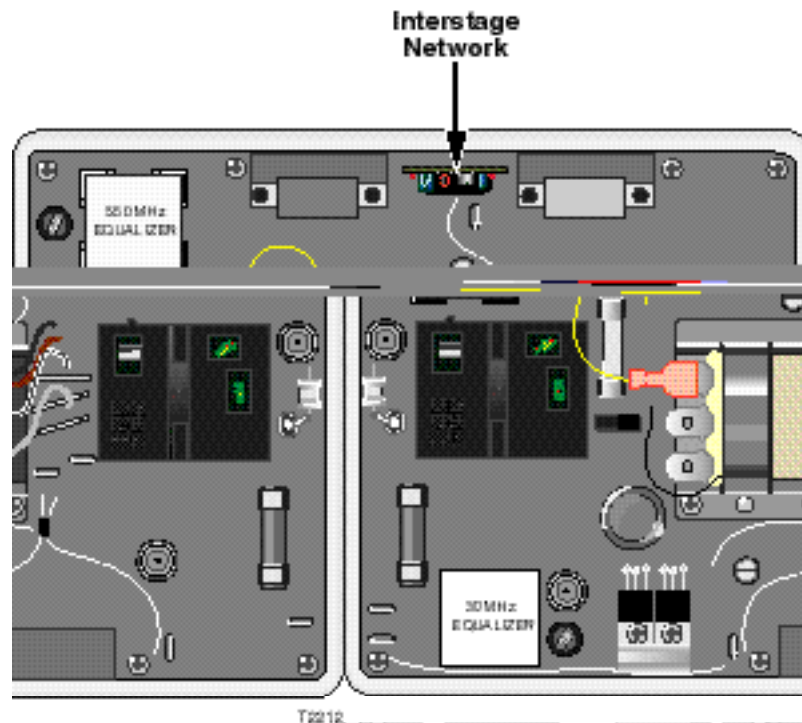

5. Ensure the pins are clean on the trim network.

Installing a Trim Network in the LEI, Continued

6. Insert the trim network into the **INTERSTAGE NETWORK**.
7. After tuning the trim network for the proper response, measure the RF output level.
8. Change the input or interstage pad to obtain the same RF output level as noted in step 3.
9. Close the LEI module cover.
10. Close the LEI housing.

Note: If the trim network is removed, install a plug-in jumper (part number 149666) or thermal in the INTERSTAGE NETWORK location.

Chapter 3

Frequency Response Plots

Overview

Introduction

The following are the frequency response plots for the GainMaker System Amplifier (GMSA), GainMaker Line Extender (GMLE), System Amplifier (SA), Distribution Amplifier (DA), Line Extender I (LEI), Line Extender II (LEII), Line Extender III (LEIII), and Line Extender III GaAs (LEIII GaAs) Trim Networks.

Chapter Contents

The following topics are included in this chapter.

Topic	See Page
5-Pin Trim Networks Response Plots	3-2
GainMaker Trim Networks Response Plots	3-37
3-Pin Trim Networks Response Plots	3-50
Card Trim Networks Response Plots	3-55

5-Pin Trim Networks Response Plots

System Amplifier, Distribution Amplifier, and Line Extender III Trim Networks Part Numbers

The following table lists the part numbers and model numbers for the 5-pin trim networks used in the SA, DA, LEIII, and LEIII GaAs. The table also shows where the corresponding trim plots can be found in this chapter.

Part Number	Model Number	Description	Response Plot
506506	HSP-3SDF	High Frequency Single Peak	Pgs. 3-3 — 3-4
500221	MSD-2SDF	Mid. Frequency Single Dip	Pgs. 3-5 — 3-6
500300	MDP-3SDF	Mid. Frequency Dual Peak	Pgs. 3-7 — 3-8
276754	LDP-2SDF	Low Frequency Dual Peak	Pgs. 3-9 — 3-10
381101	MDP-2SDF	Mid. Frequency Dual Peak	Pgs. 3-11 — 3-12
381102	MSD-1SDF	Mid. Frequency Dip	Pgs. 3-13 — 3-14
501769	HSP-3NDF	High Frequency Single Peak	Pgs. 3-15 — 3-17
536640	HSP-3SDFL	High Frequency Single Peak w/ Low Pass Filter	Pg. 3-18
536644	MSD-2SDFL	Mid. Frequency Single Dip w/ Low Pass Filter	Pgs. 3-19 — 3-20
712557	MSD-2NNF	Mid. Frequency Dual Peak	Pgs. 3-33 — 3-36

750 MHz Line Extender II Trim Networks Part Numbers

The following table lists the part numbers and model numbers for the 5-pin trim networks used in the 750 MHz LEII. The table also shows where the corresponding trim plots can be found in this chapter.

Part Number	Model Number	Description	Response Plot
541635	HSP-2NNF	High Frequency Single Peak	Pgs. 3-21 — 3-22
541636	MSD-2NNF	Mid. Frequency Single Dip	Pgs. 3-23 — 3-24
541637	LDP-2NNF	Low/High Frequency Peak	Pgs. 3-25 — 3-26
544125*	HSP-2NNF W/HPF	High Frequency Single Peak with High Pass Filter	Pgs. 3-27 — 3-28
544126*	MSD-2NNF W/HPF	Mid. Frequency Single Dip with High Pass Filter	Pgs. 3-29 — 3-30
544127*	LDP-2NNF W/HPF	Low Frequency Dual Peak with High Pass Filter	Pgs. 3-31 — 3-32

5-Pin Trim Networks Response Plots, Continued

HSP-3SDF - part number 506506

High Frequency Peak

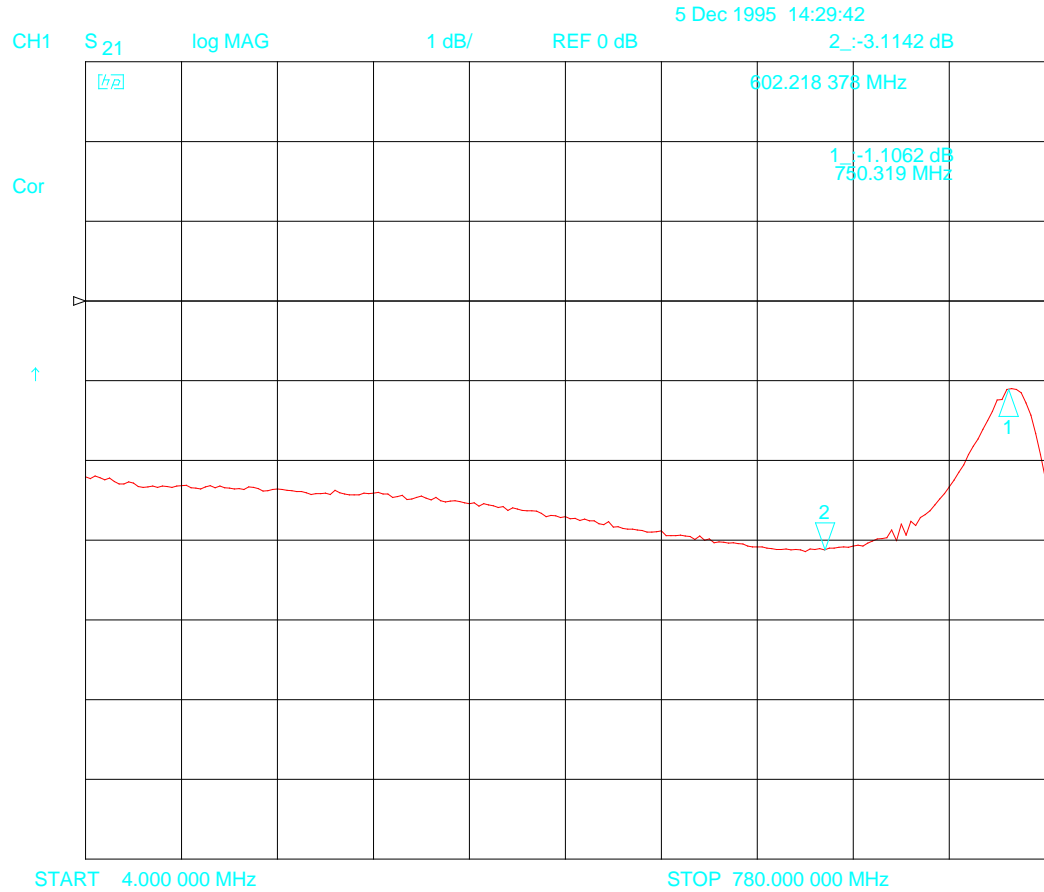

C1 adjusted to depict the peak's maximum range.

C1 adjusts the frequency of the peak between 326 MHz and 750 MHz.
Insertion loss varies from 2 to 4 dB.

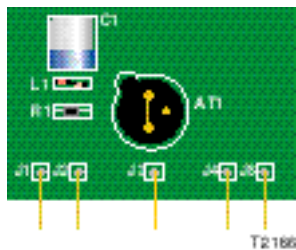

5-Pin Trim Networks Response Plots, Continued

HSP-3SDF - part number 506506, continued

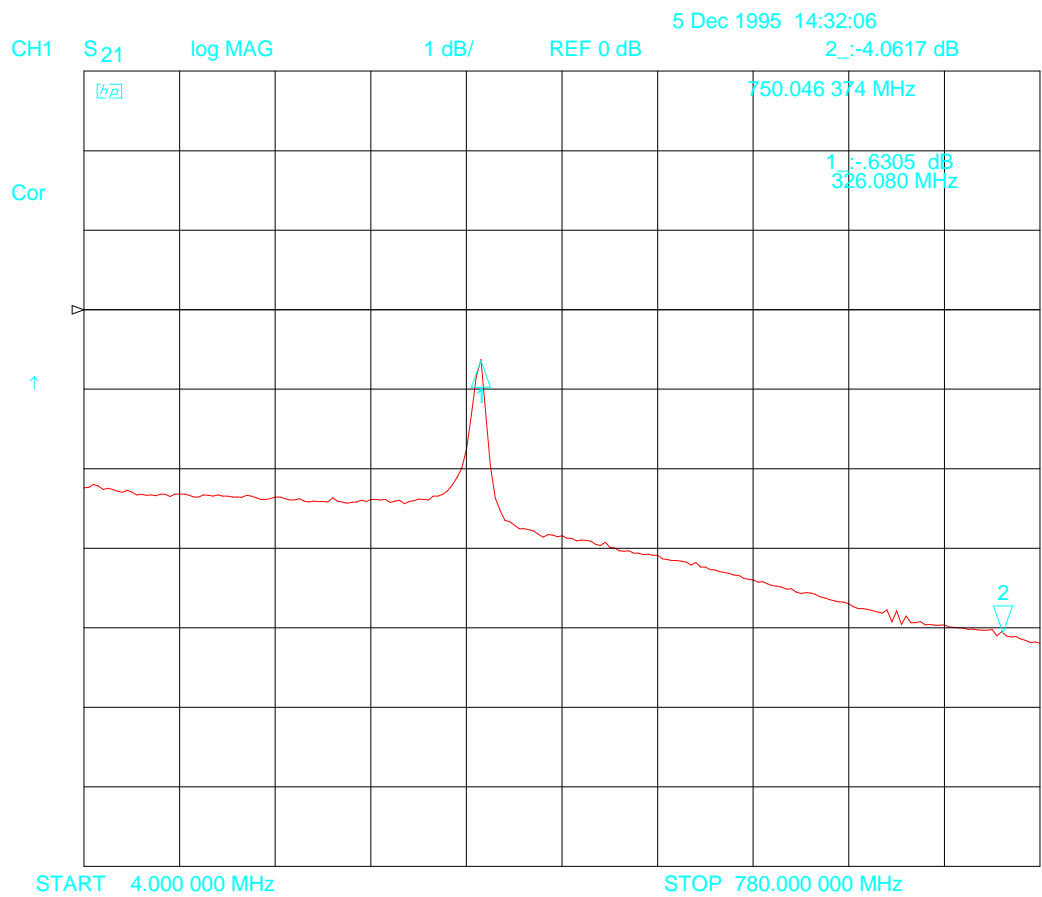

C1 adjusted to depict peak tuned to minimum range.

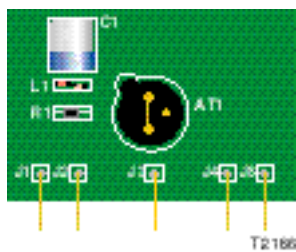

5-Pin Trim Networks Response Plots, Continued

MSD-2SDF - part number 500221

Mid. Frequency Single Dip

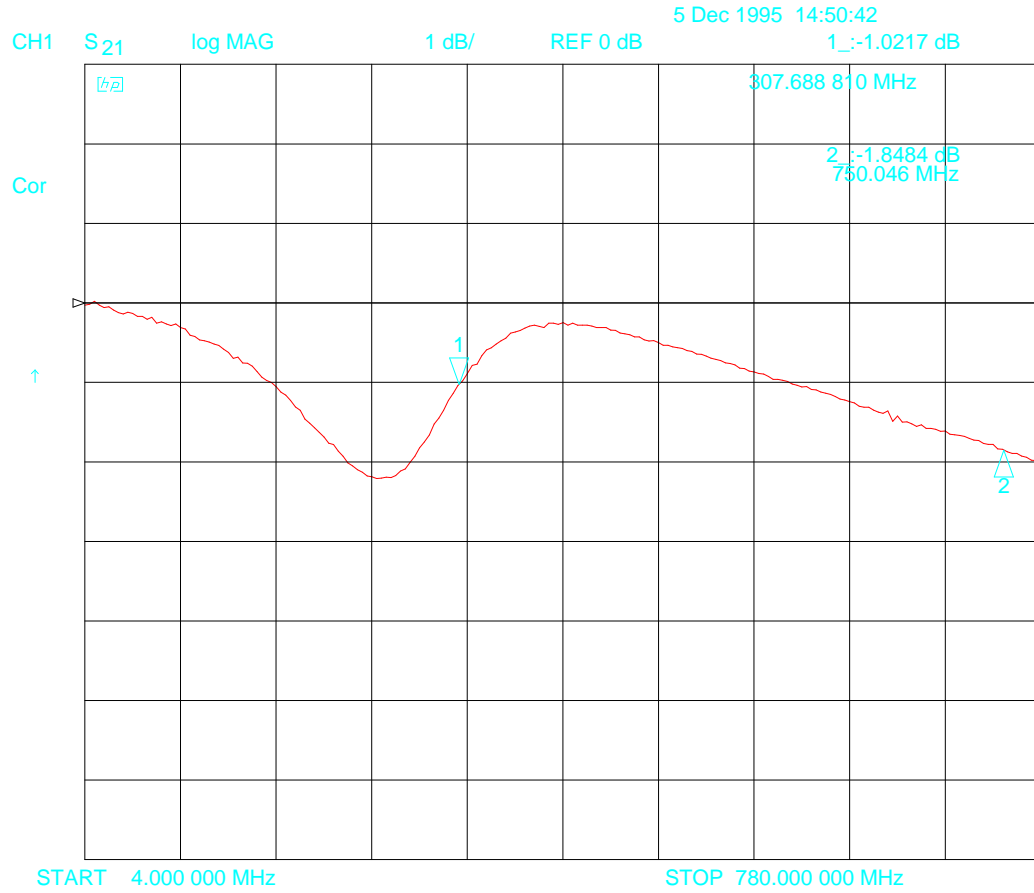

C1 is tuned near the maximum range. L1 is tuned for a broad dip.

C1 varies frequency of the dip between 150 MHz and 308 MHz.

R2 adjusts amplitude of the dip.

L1 adjusts width of the dip.

Insertion loss is equal to 2 dB.

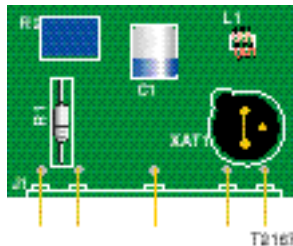

5-Pin Trim Networks Response Plots, Continued

MSD-2SDF - part number 500221, continued

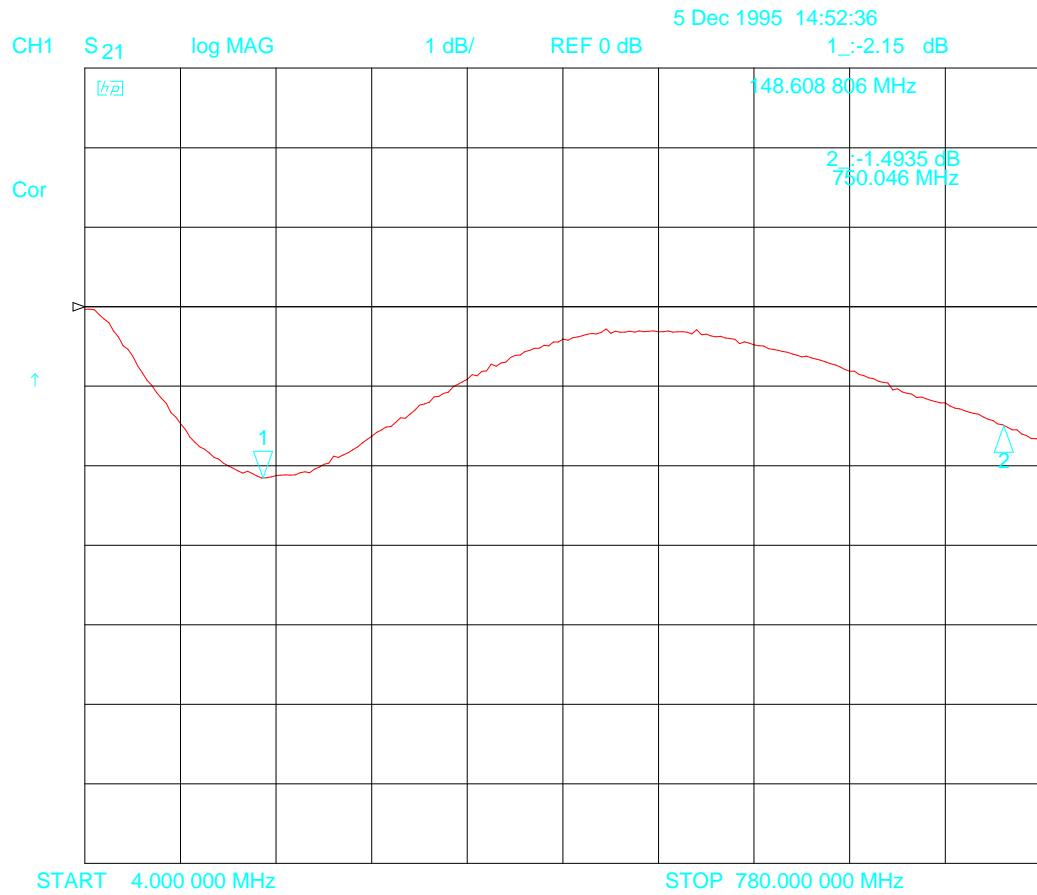

C1 adjusted to the dip's minimum range. L1 adjusted to broaden the dip.

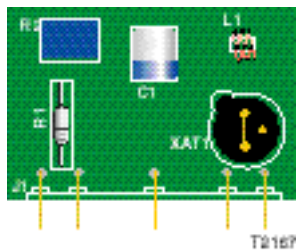

5-Pin Trim Networks Response Plots, Continued

MDP-3SDF - part number 500300

Combination Peak / Dip

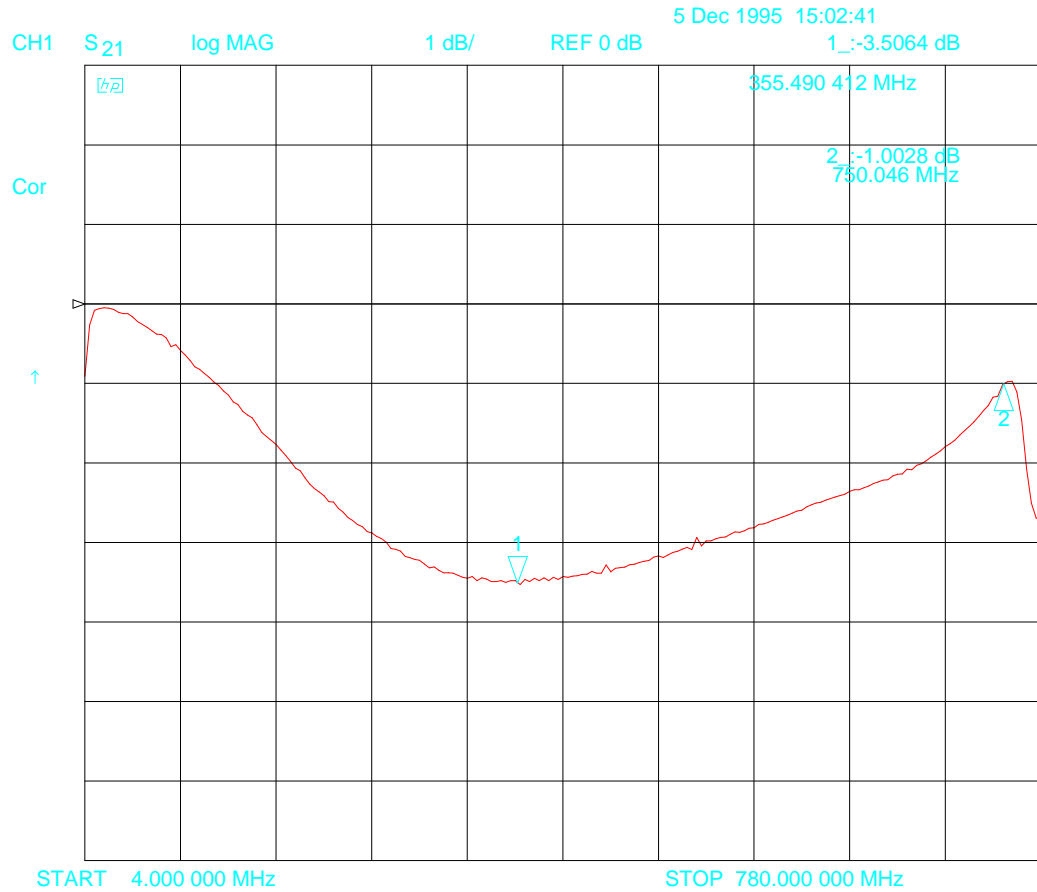

C1 adjusted for maximum range.

C1 adjusts the high peak frequency between 325 MHz and 780 MHz.

L1 adjusts the frequency range of C1.

L3 adjusts the dip's frequency between 118 MHz and 355 MHz.

L1 adjusted for a broad dip.

Average insertion loss is 3 dB.

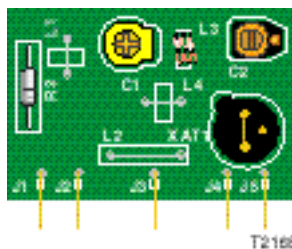

5-Pin Trim Networks Response Plots, Continued

MDP-3SDF - part number 500300, continued

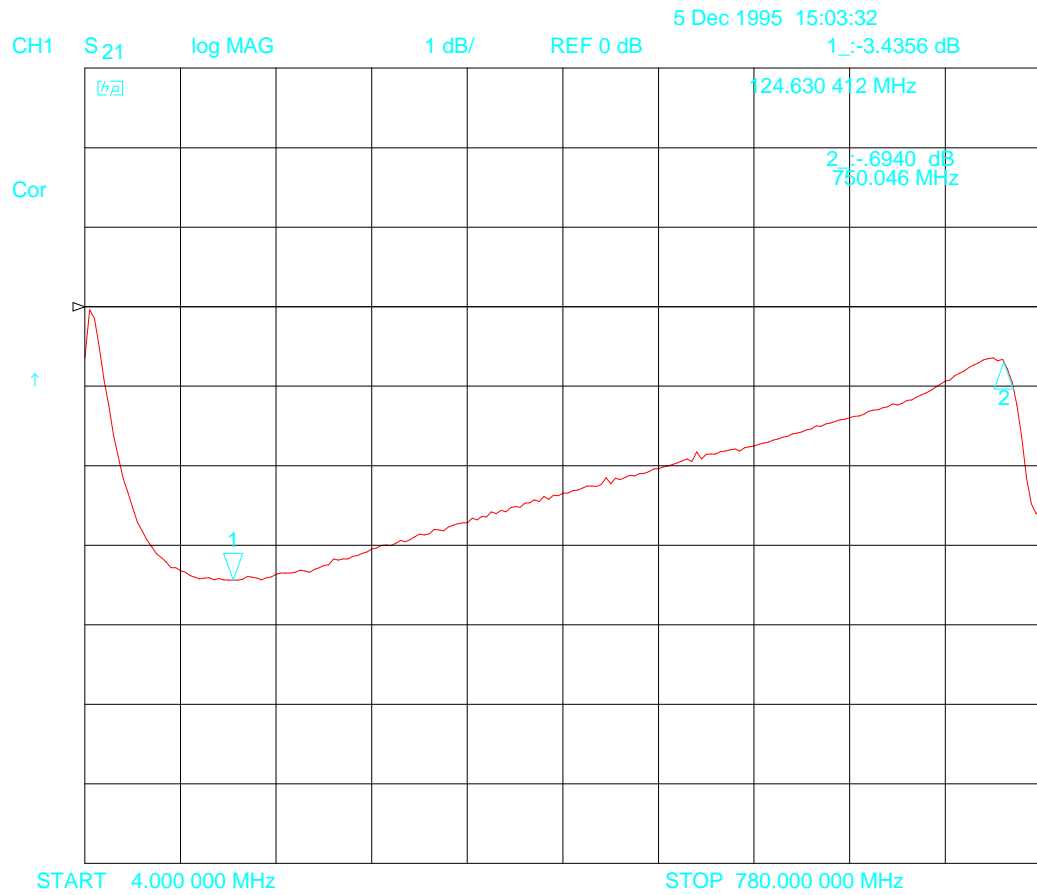

L1 tuned for a narrower dip.

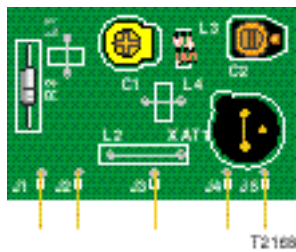

5-Pin Trim Networks Response Plots, Continued

LDP-2SDF - part number 276754

Low Frequency Dual Peak

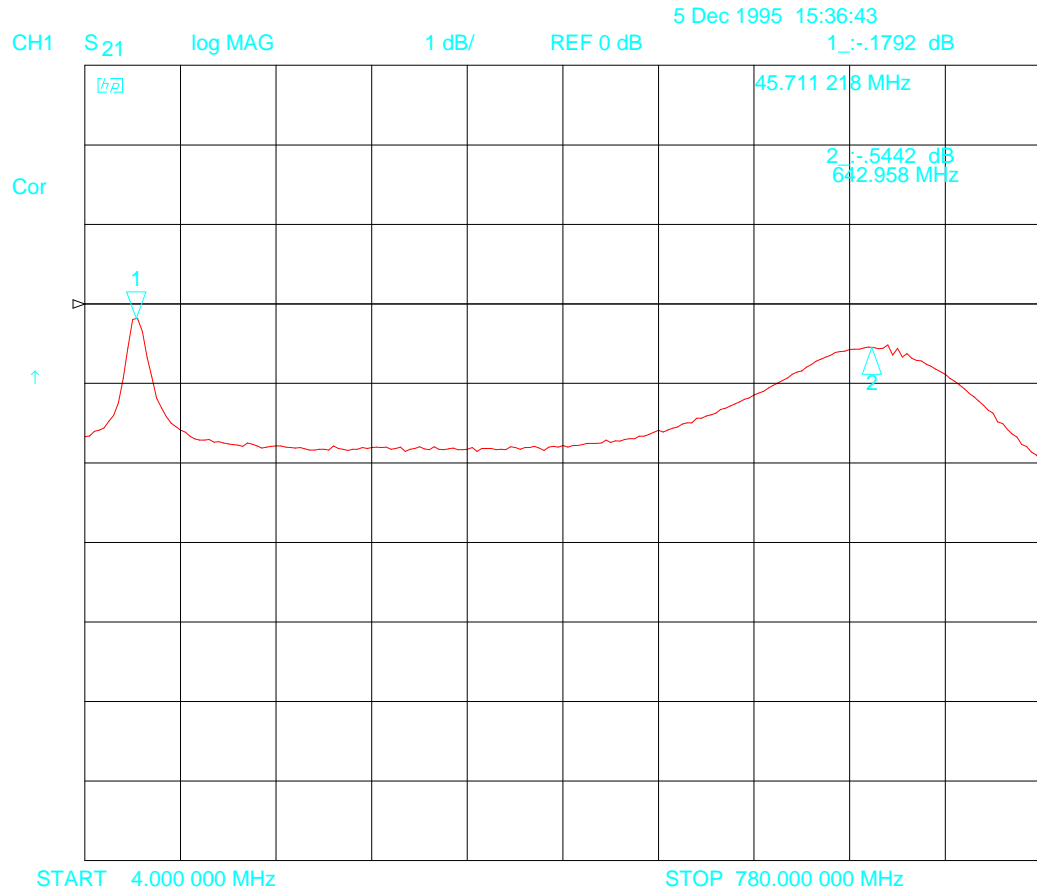

C2 adjusted to depict its minimum range.
C1 is adjusted to depict its maximum range.

C1 adjusts the high peak frequency between 341 MHz and 653 MHz.
 C2 adjusts the low peak frequency between 45 MHz and 146 MHz.
 L2 (or 1.2 as shown on trim) adjusts the range of C2.
 Insertion loss is equal to 2 dB.

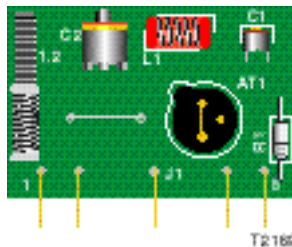

5-Pin Trim Networks Response Plots, Continued

LDP-2SDF - part number 276754, continued

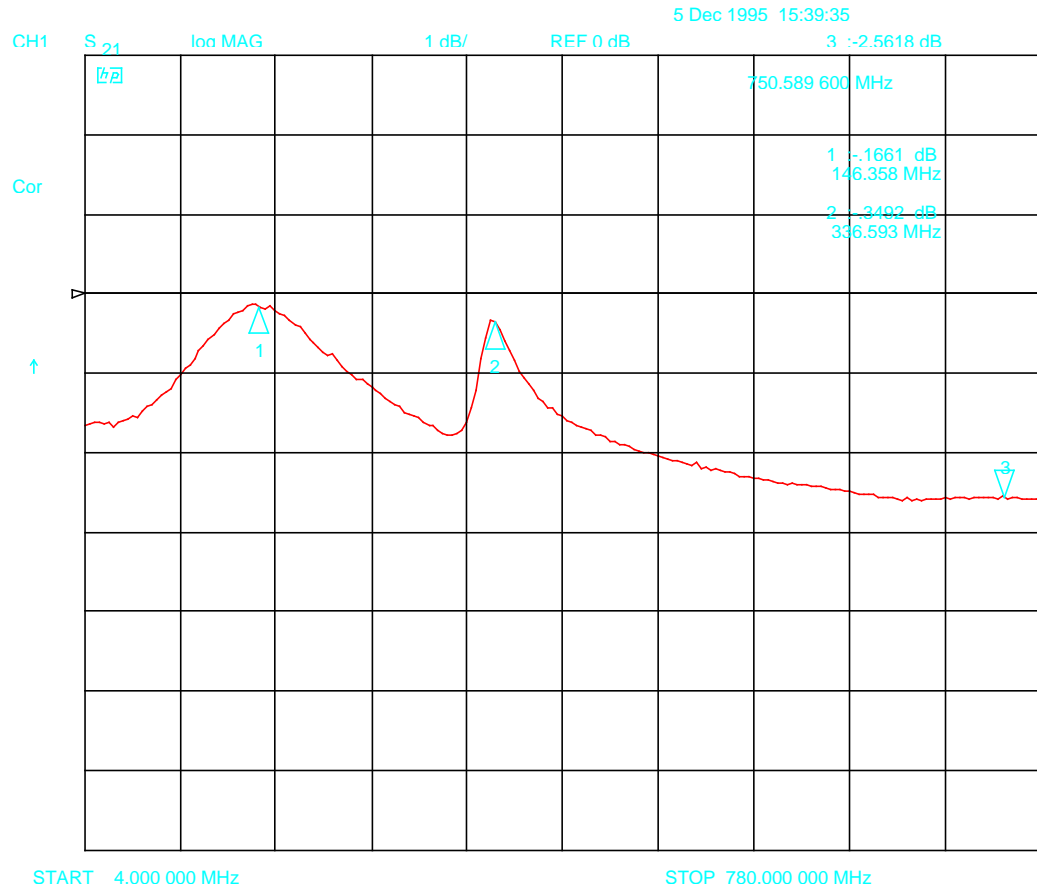

C2 adjusted to maximum range. C1 adjusted to minimum range.

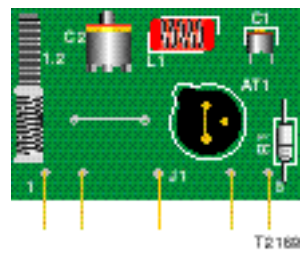

5-Pin Trim Networks Response Plots, Continued

MDP-2SDF - part number 381101

Mid. Frequency Dual Peak

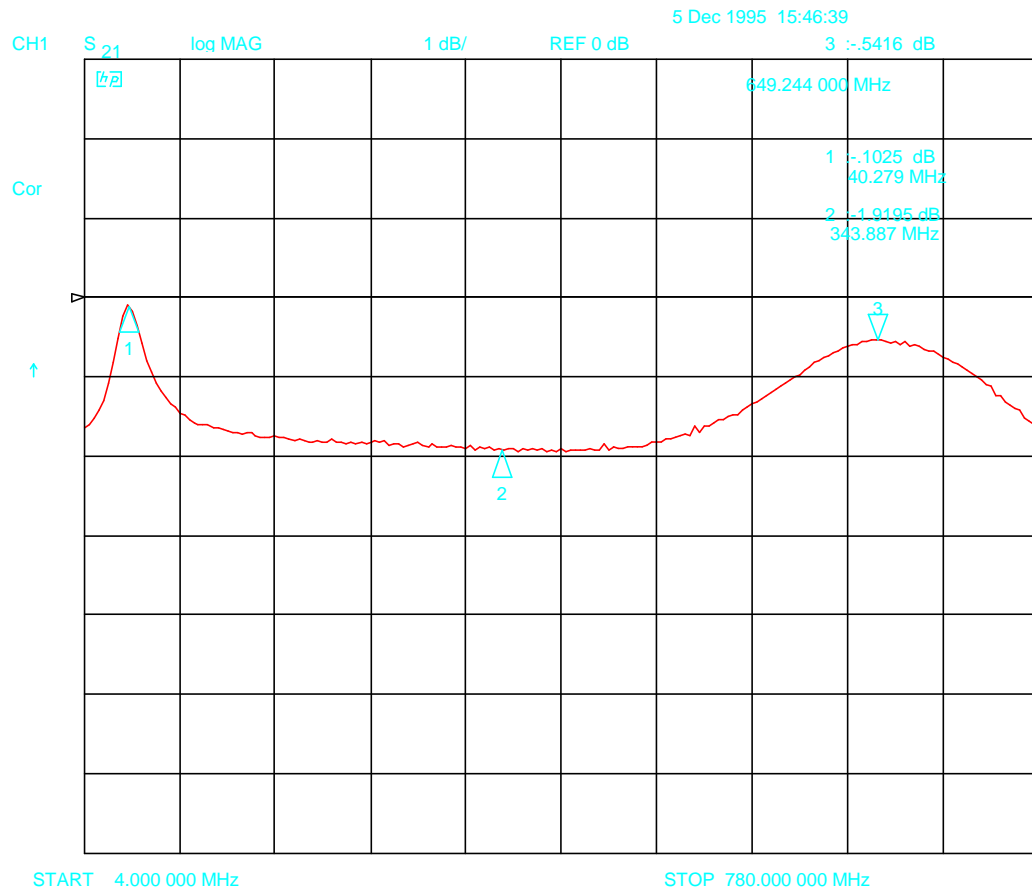

C2 adjusted to minimum range. C1 adjusted to maximum range.

C1 adjusts the high peak frequency between 344 MHz and 650 MHz.

C2 adjusts the low peak frequency between 41 MHz and 84 MHz.

Insertion loss is equal to 2 dB.

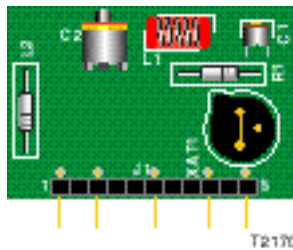

5-Pin Trim Networks Response Plots, Continued

MDP-2SDF - part number 381101, continued

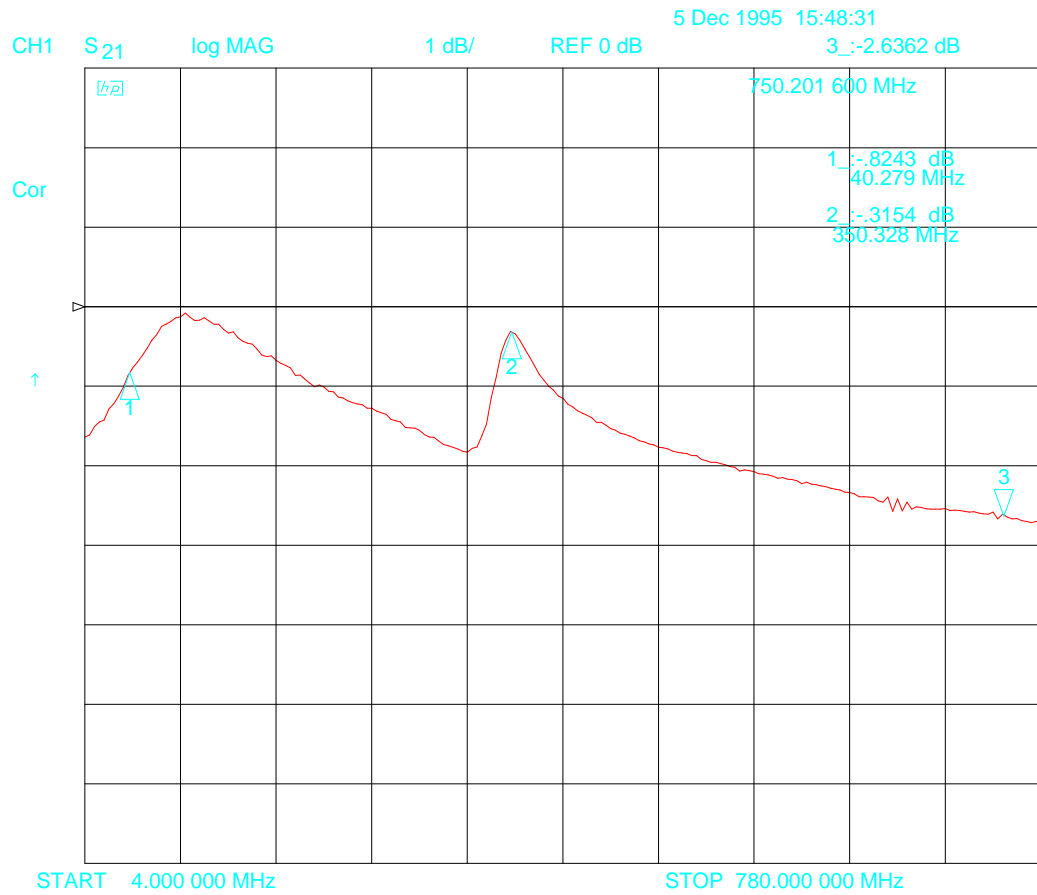

C2 adjusted to maximum range. C1 adjusted to minimum range.

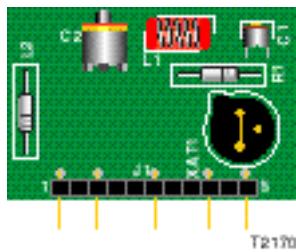

5-Pin Trim Networks Response Plots, Continued

MSD-1SDF - part number 381102

Mid. Frequency Dip

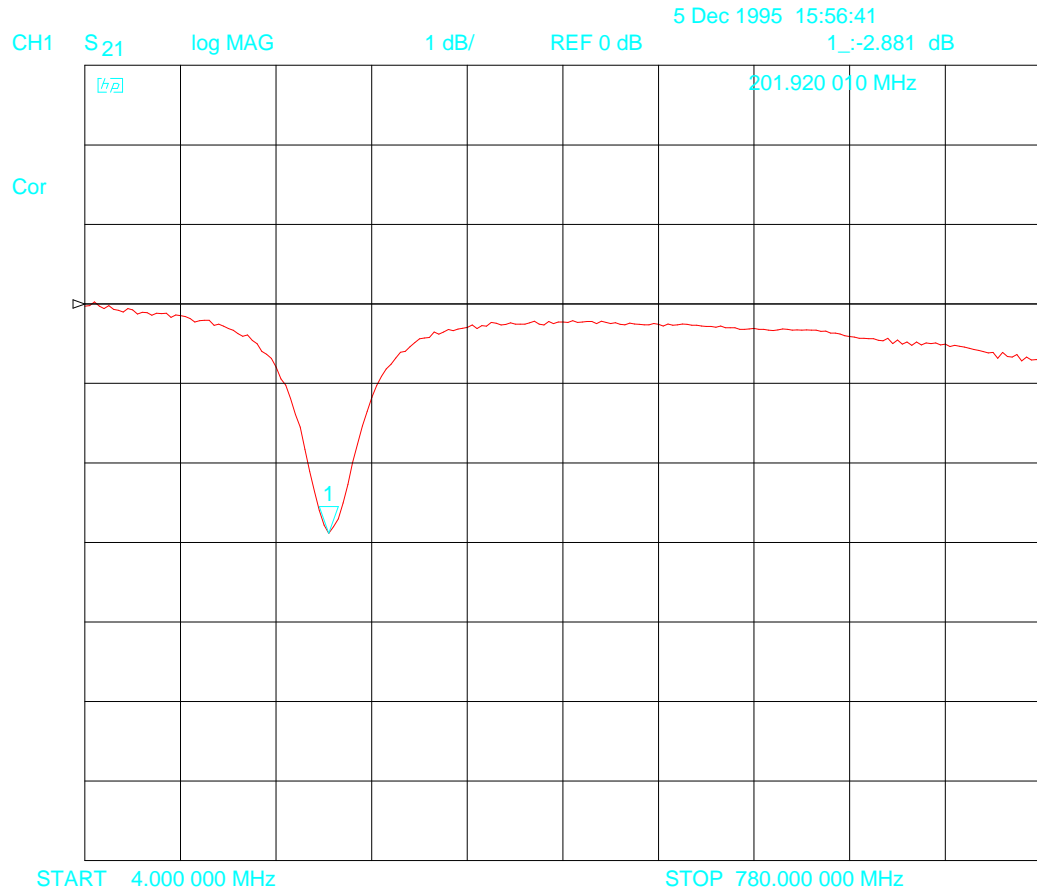

C3 adjusted to depict maximum range.

C3 adjusts the dip's frequency between 108 MHz and 202 MHz.

L1 adjusts the range of C3.

R1 adjusts the dip's amplitude.

Insertion loss is equal to 1 dB.

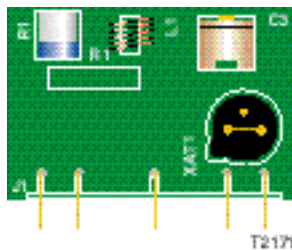

5-Pin Trim Networks Response Plots, Continued

MSD-1SDF - part number 381102, continued

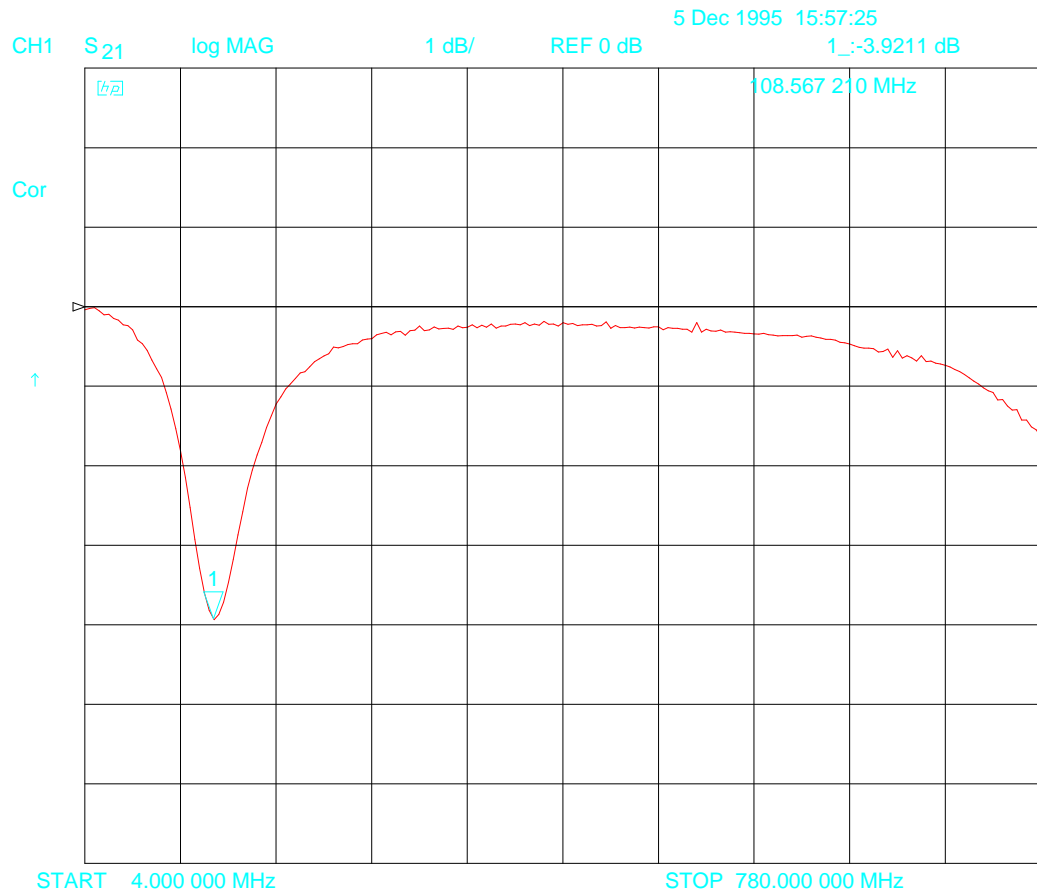

C3 adjusted to depict minimum range.

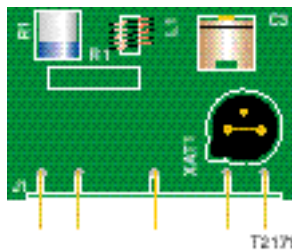

5-Pin Trim Networks Response Plots, Continued

HSP-3NDF - part number 501769

High Frequency Single Peak

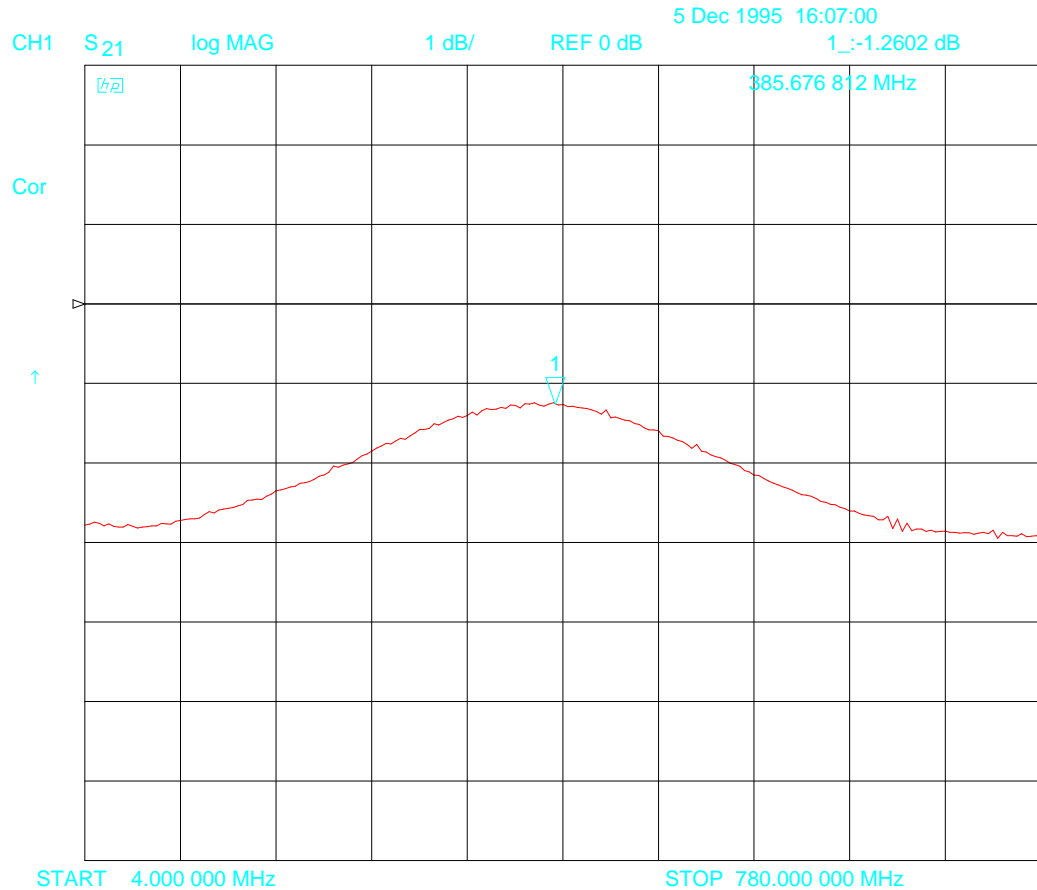

C1 adjusted to depict maximum range.

C1 adjusts the peak's frequency between 275 MHz and 385 MHz.

R2 and R3 adjust the peak's amplitude.

L1 adjusts the range of C1.

Insertion loss is equal to 3 dB.

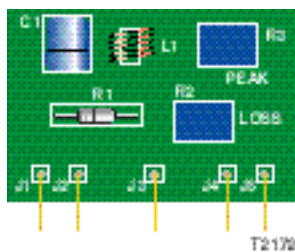

5-Pin Trim Networks Response Plots, Continued

HSP-3NDF - part number 501769, continued

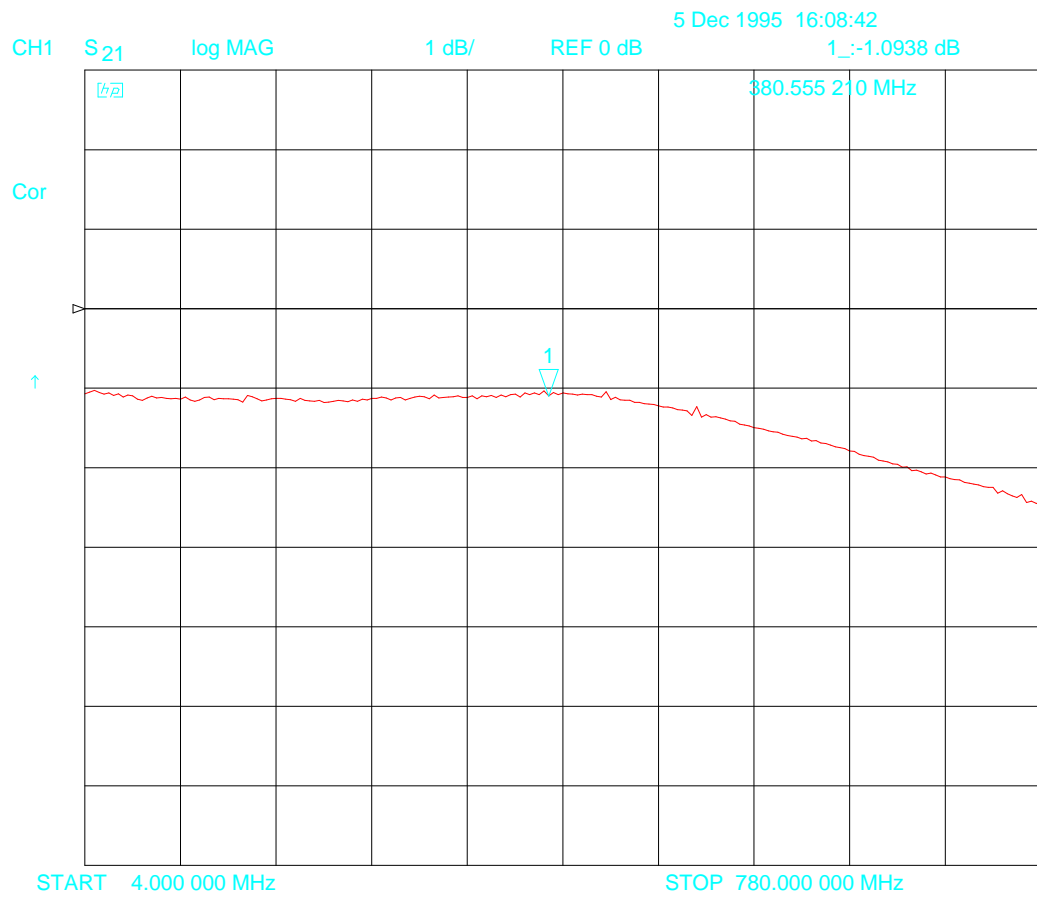

R2 adjusted for minimum loss.

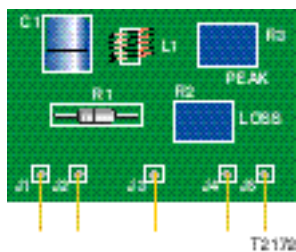

5-Pin Trim Networks Response Plots, Continued

HSP-3NDF - part number 501769, continued

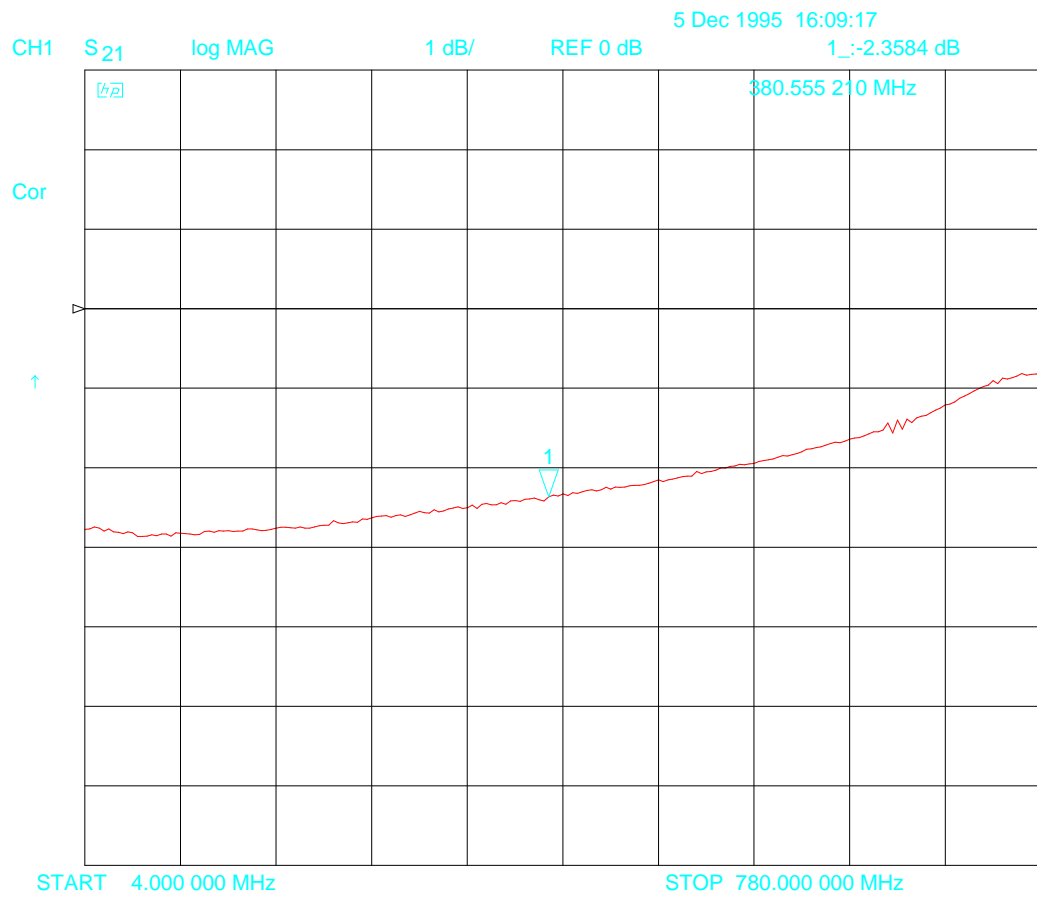

R3 adjusted for minimum loss.

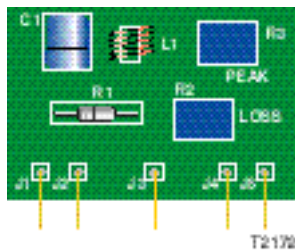

5-Pin Trim Networks Response Plots, Continued

HSP-3SDFL - part number 536640

High Frequency Single Peak

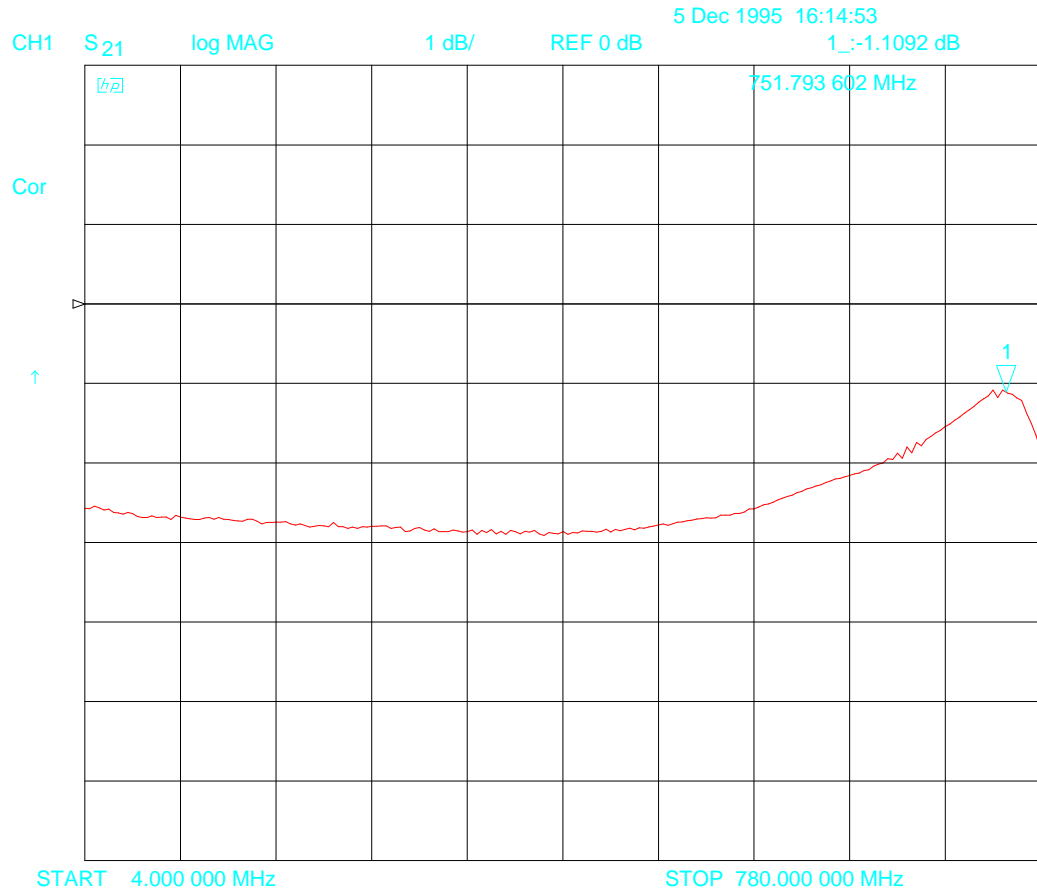

C1 adjusted to maximum of range.

C1 adjusts the high peak frequency.
Insertion loss is equal to 3 dB.

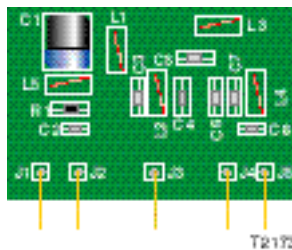

5-Pin Trim Networks Response Plots, Continued

MSD-2SDFL - part number 536644

Mid. Frequency Single Dip

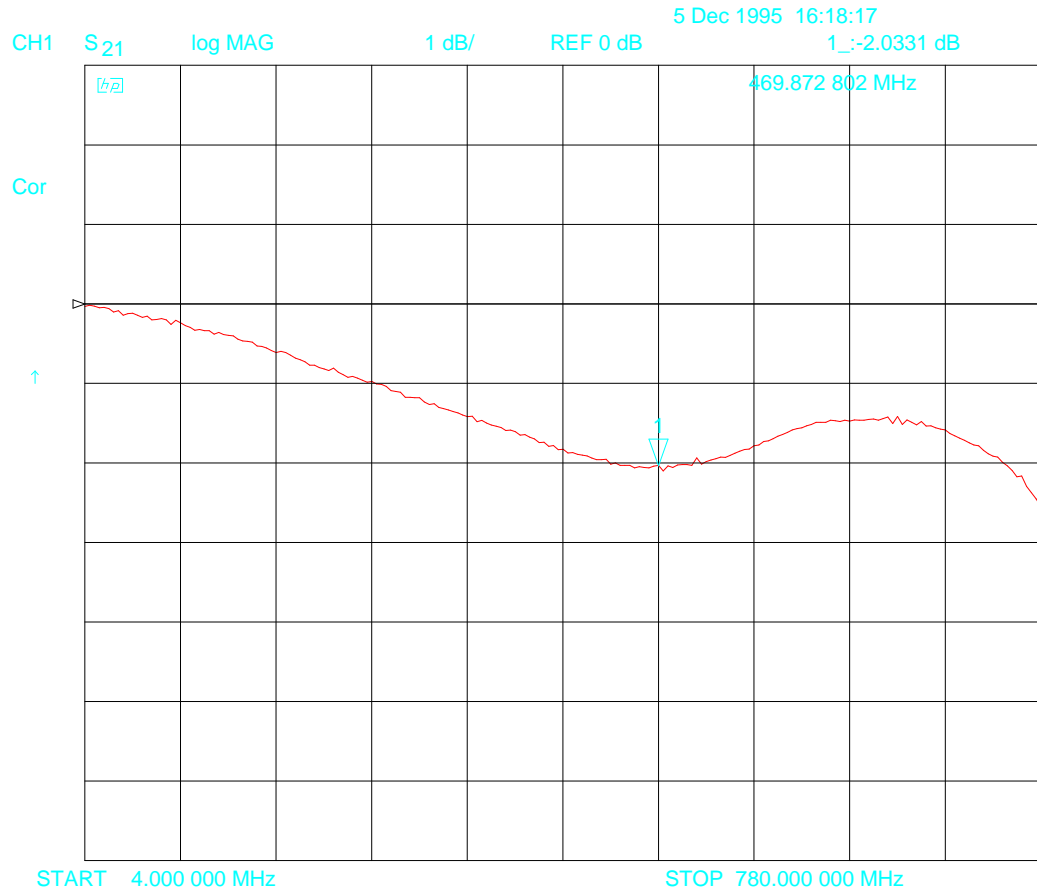

C1 adjusted to top of its range.

C1 adjusts dip frequency.
R2 adjusts dip amplitude.
Insertion loss is equal to 2 dB.

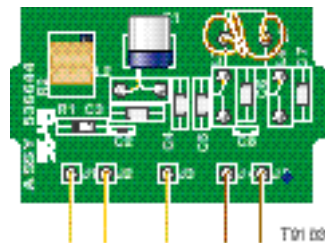

5-Pin Trim Networks Response Plots, Continued

MSD-2SDFL - part number 536644, continued

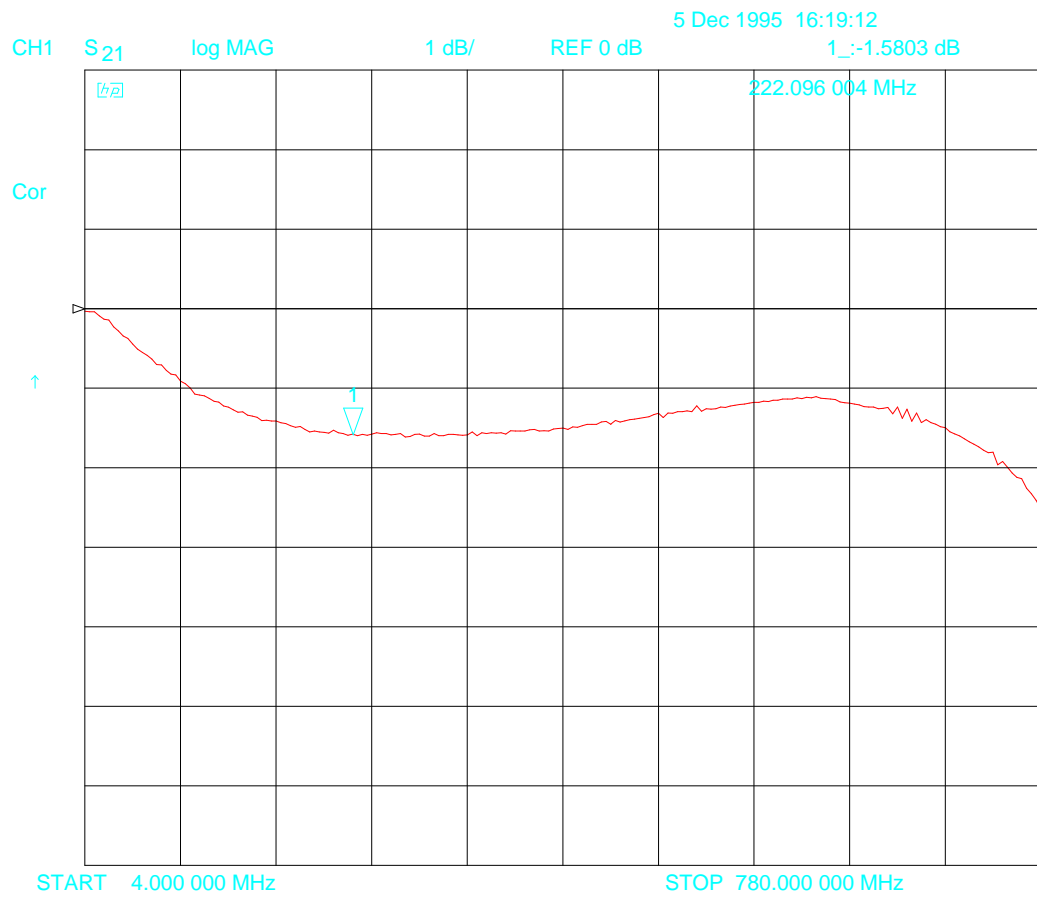

C1 adjusted to bottom of its range.

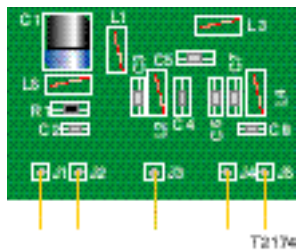

5-Pin Trim Networks Response Plots, Continued

HSP-2NNF - part number 541635

High Frequency Single Peak

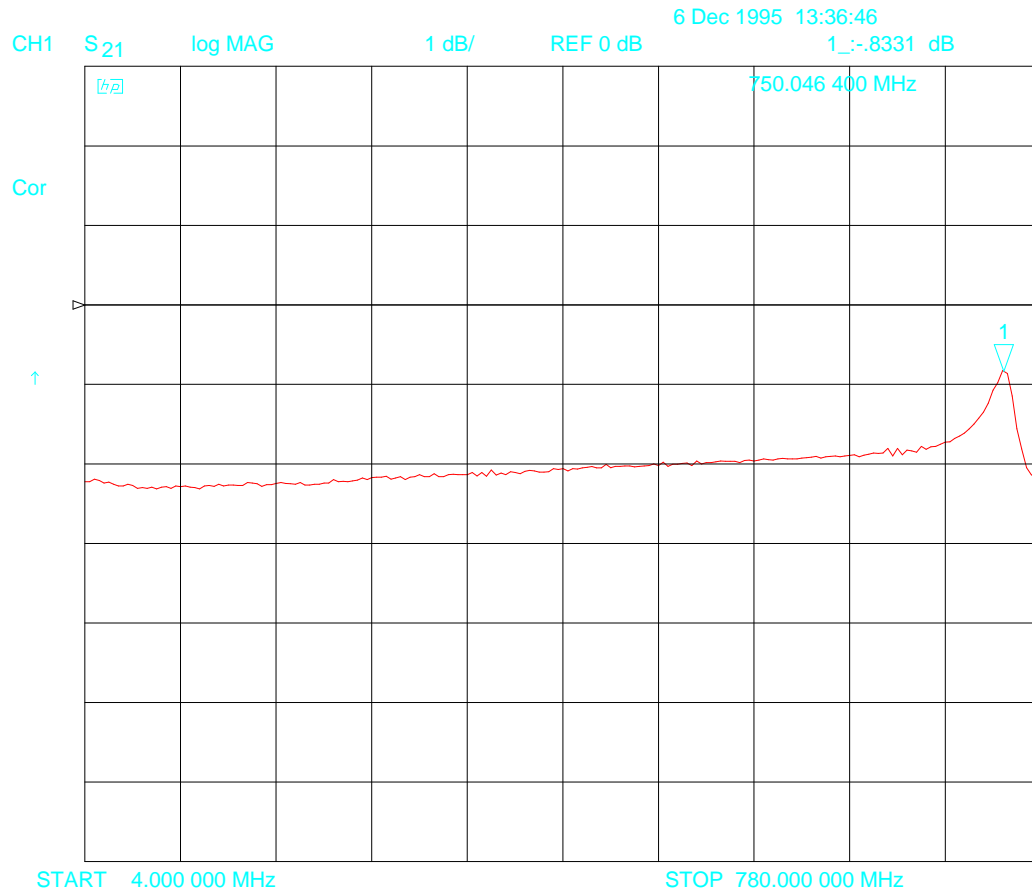

C1 adjusted to depict the peak's maximum range.

C1 varies the peak frequency between 590 MHz and 780 MHz.
Insertion loss is equal to 2 dB.

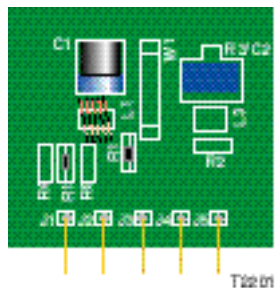

5-Pin Trim Networks Response Plots, Continued

HSP-2NNF - part number 541635, continued

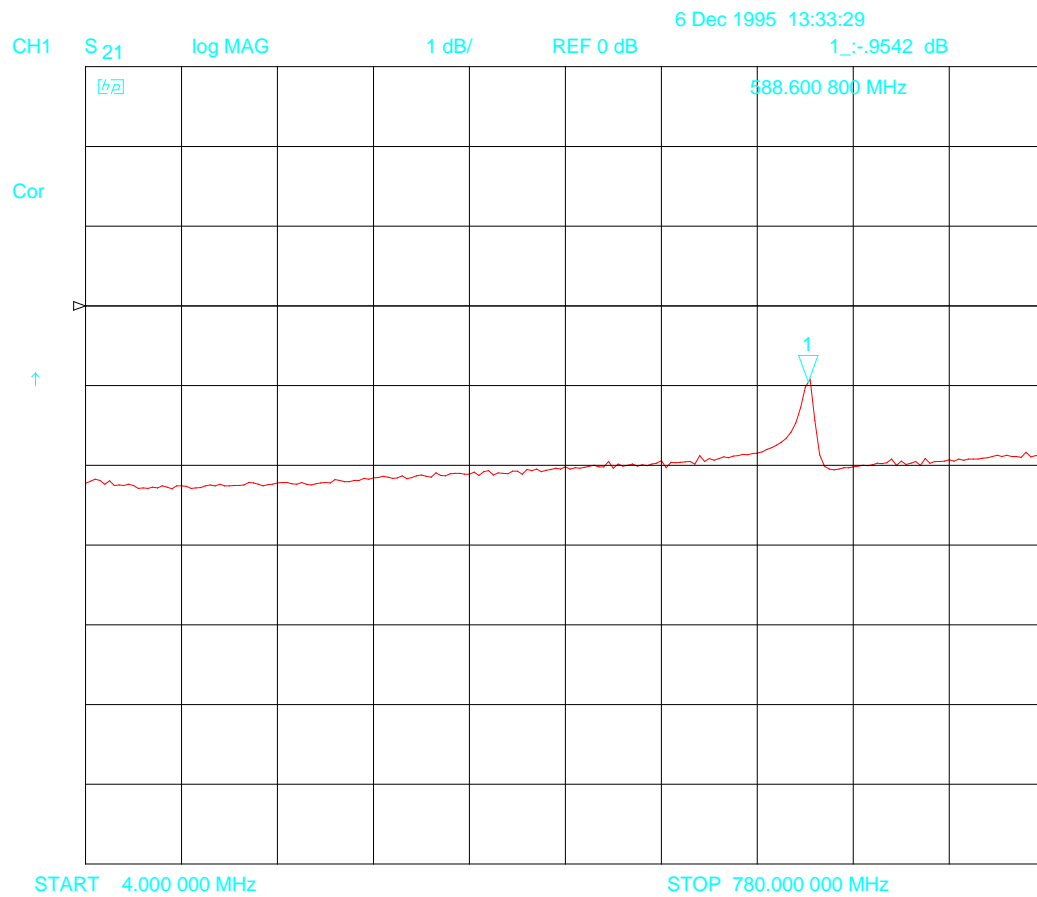

C1 adjusted to depict the peak's minimum range.

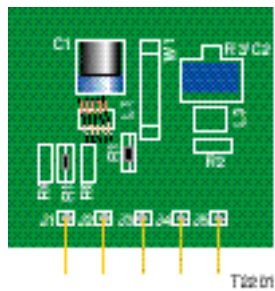

5-Pin Trim Networks Response Plots, Continued

MSD-2NNF - part number 541636

Mid. Frequency Dip

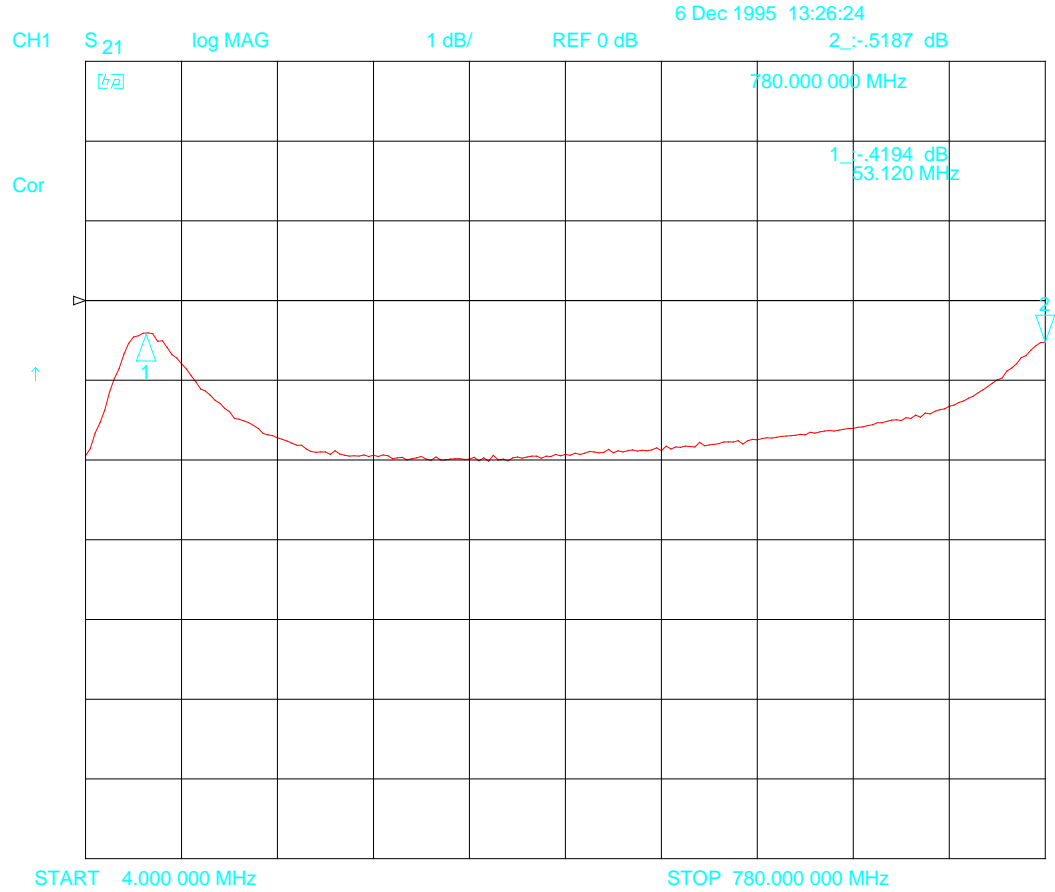

C1 adjusted to depict the dip's maximum range.

- C1 varies frequency of the dip.
- R3 controls amplitude of the dip.
- L2 controls range of C1.
- Insertion loss is equal to 2 dB.

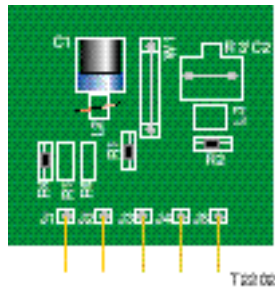

5-Pin Trim Networks Response Plots, Continued

MSD-2NNF - part number 541636, continued

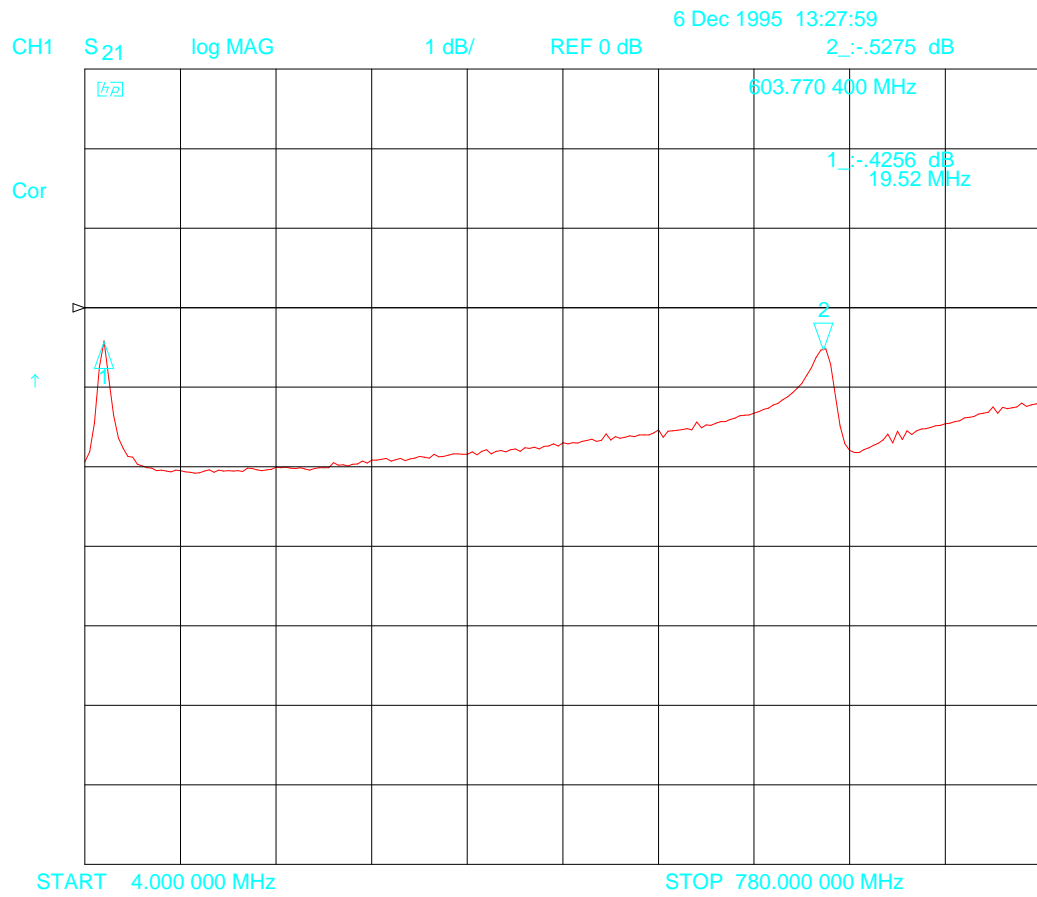

C1 adjusted to depict the dip's minimum range.

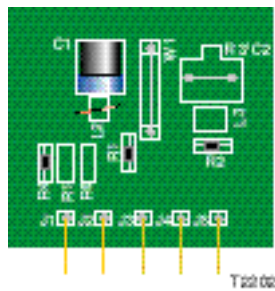

5-Pin Trim Networks Response Plots, Continued

LDP-2NNF - part number 541637

Low Frequency Dual Peak

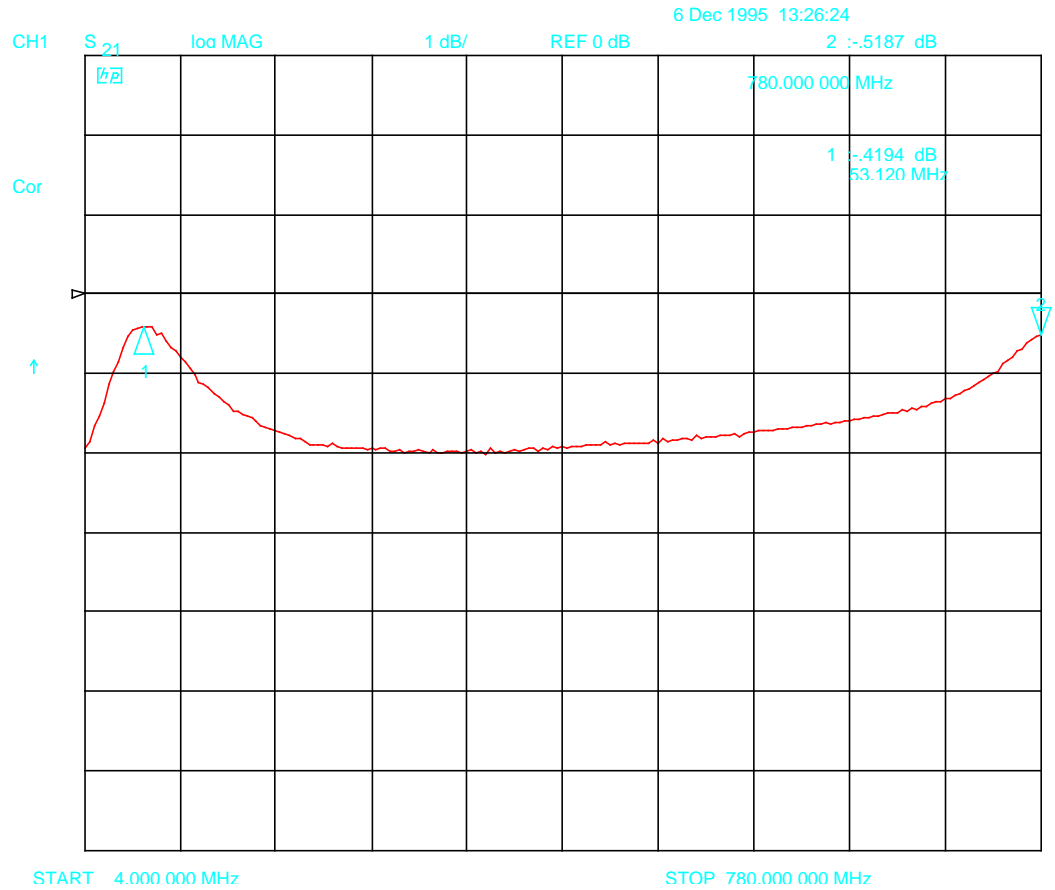

C1 and C2 adjusted to depict both peaks at maximum range.

C1 varies the frequency of the high peak between 605 MHz and 780 MHz.

C2 varies the frequency of the low peak between 19 MHz and 54 MHz.

Insertion loss is equal to 2 dB.

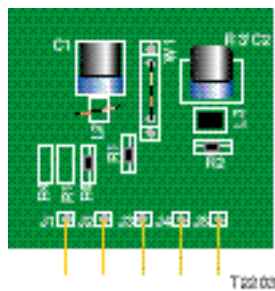

5-Pin Trim Networks Response Plots, Continued

LDP-2NNF - part number 541637, continued

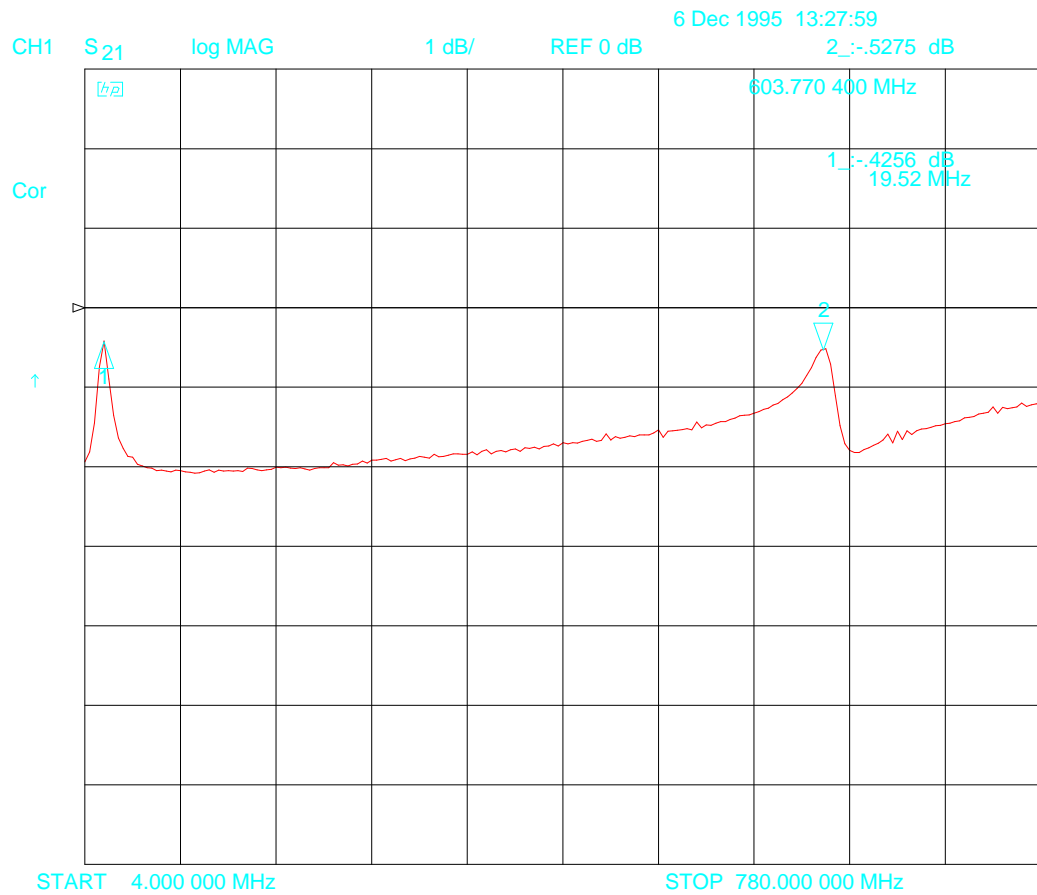

C1 and C2 adjusted to depict both peaks at minimum range.

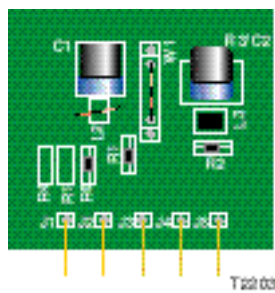

5-Pin Trim Networks Response Plots, Continued

HSP-2NNF-HPF - part number 544125

High Frequency Peak

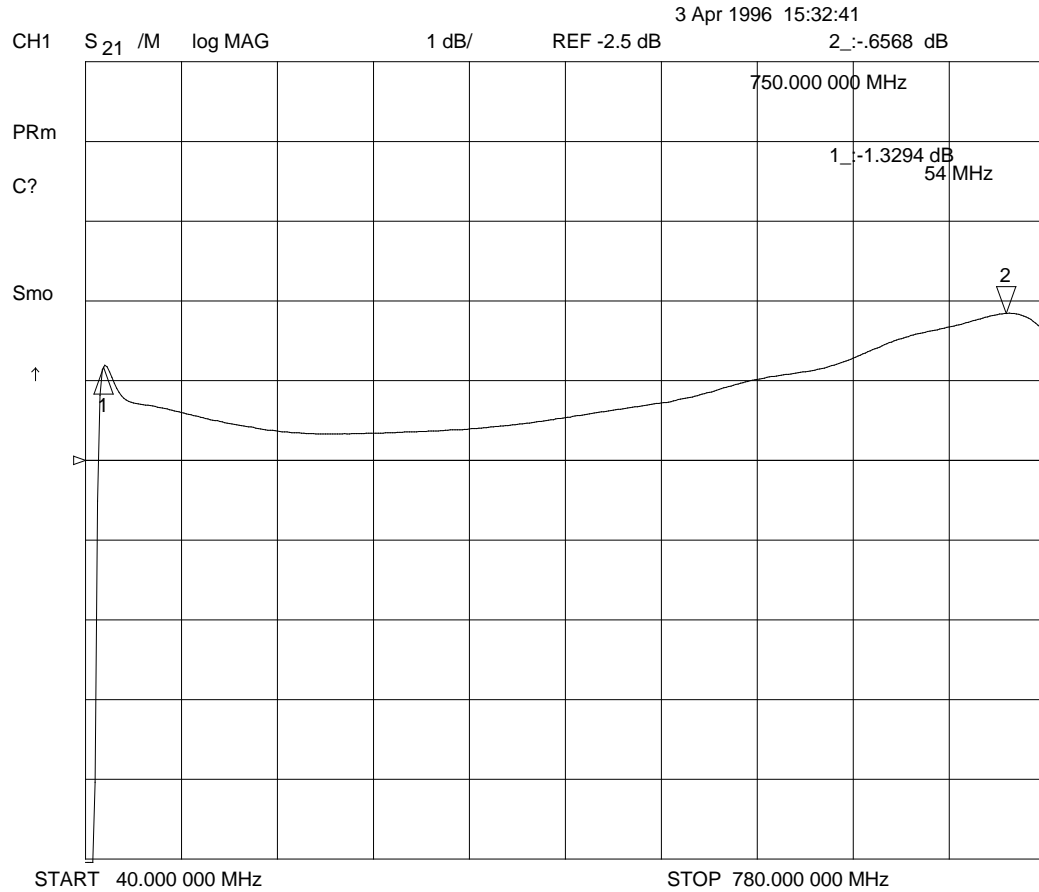

C8 adjusted to depict the peak at 750 MHz.

C8 varies the peak frequency from 590 MHz to 780 MHz.

Fixed low frequency peak at 54 MHz.

54 MHz high pass filter.

Insertion loss is equal to 2 dB.

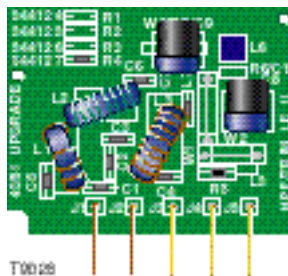

5-Pin Trim Networks Response Plots, Continued

HSP-2NNF-HPF - part number 544125, continued

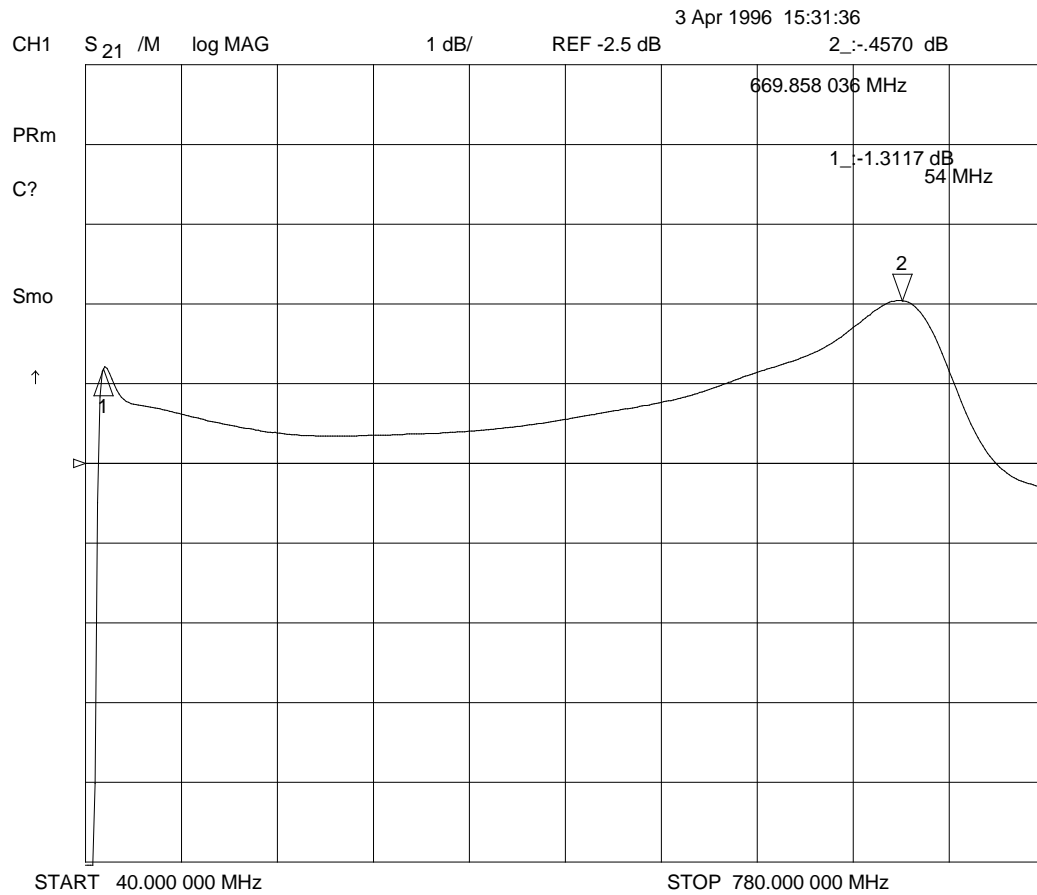

C8 adjusted to depict peak at minimum range.

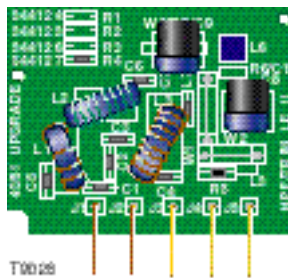

5-Pin Trim Networks Response Plots, Continued

MSD-2NNF-HPF - part number 544126

Mid. Frequency Dip

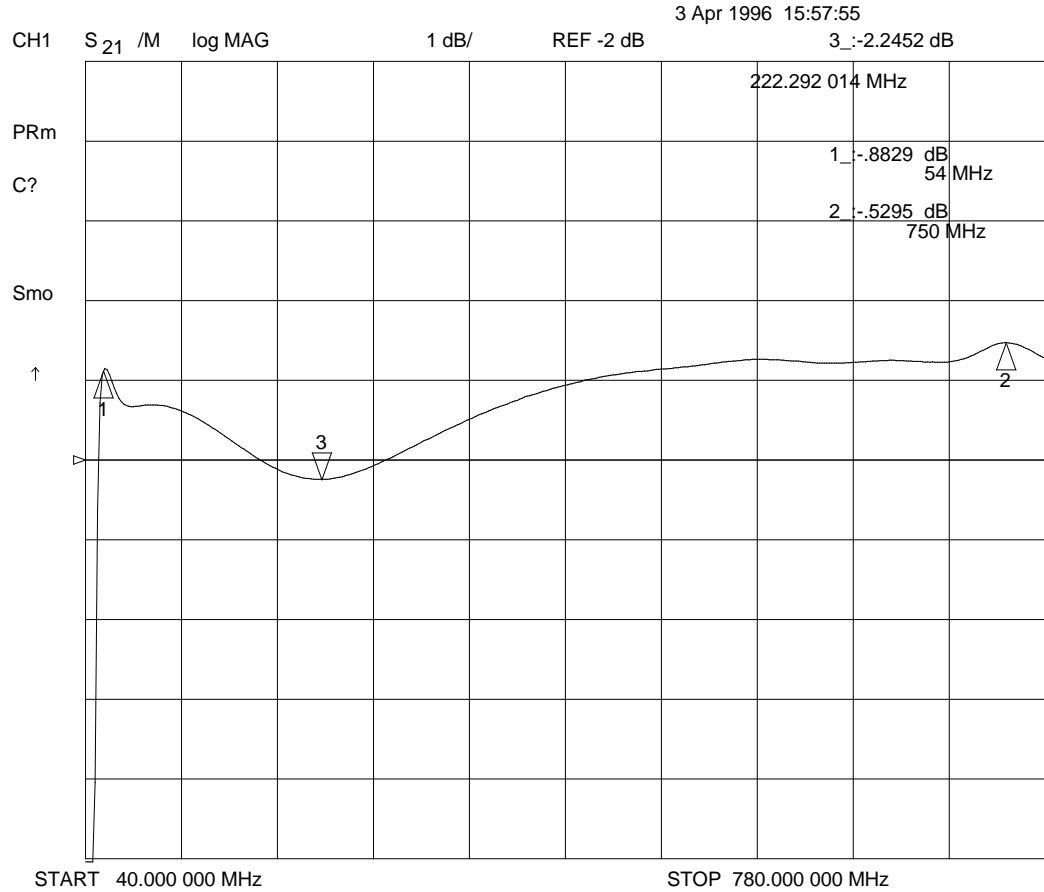

C10 adjusted to depict dip at minimum range.

C8 varies frequency of the dip.

R9 varies the amplitude of the dip.

Fixed low frequency peak at 54 MHz.

54 MHz high pass filter.

Insertion loss is equal to 2 dB.

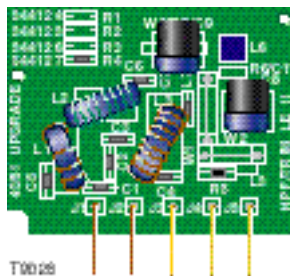

5-Pin Trim Networks Response Plots, Continued

MSD-2NNF-HPF - part number 544126, continued

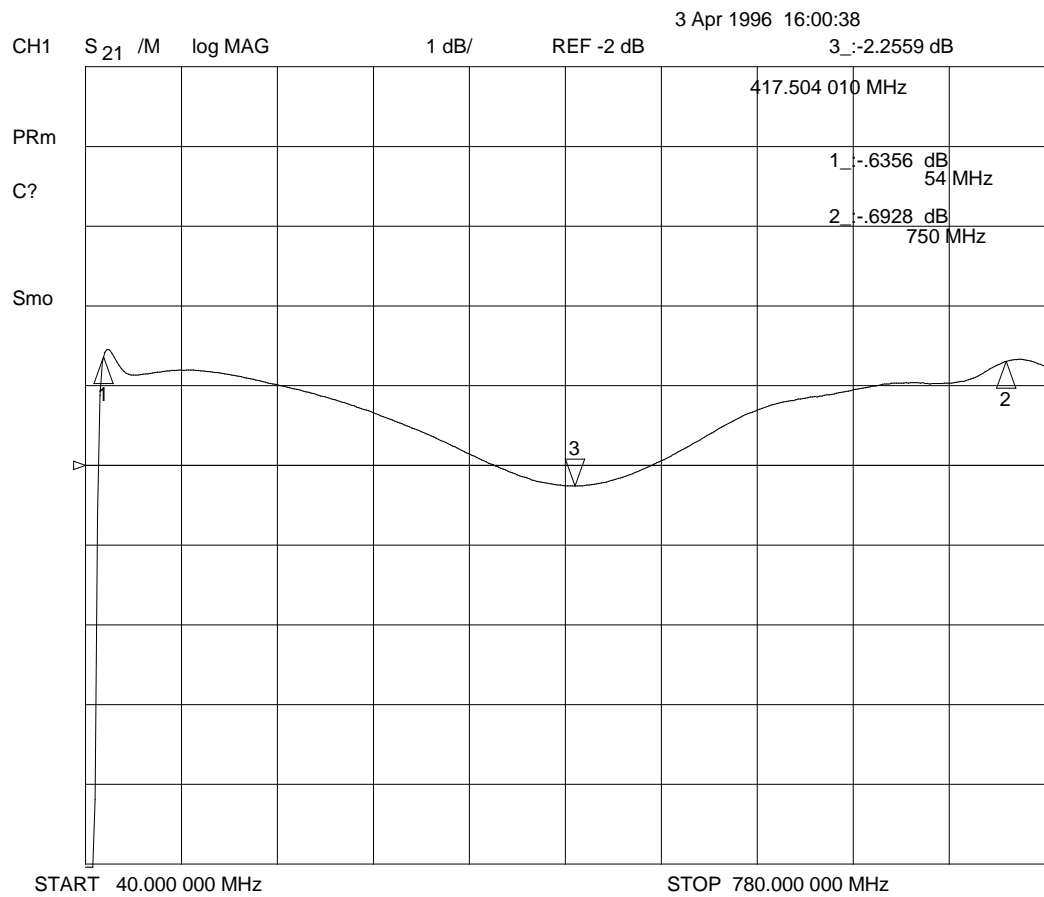

C10 adjusted to depict maximum frequency.

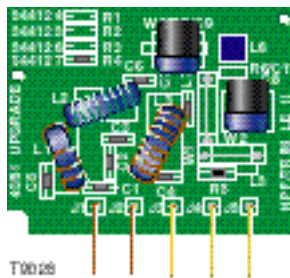

5-Pin Trim Networks Response Plots, Continued

LDP-2NNF-HPF - part number 544127

Low Frequency Peak

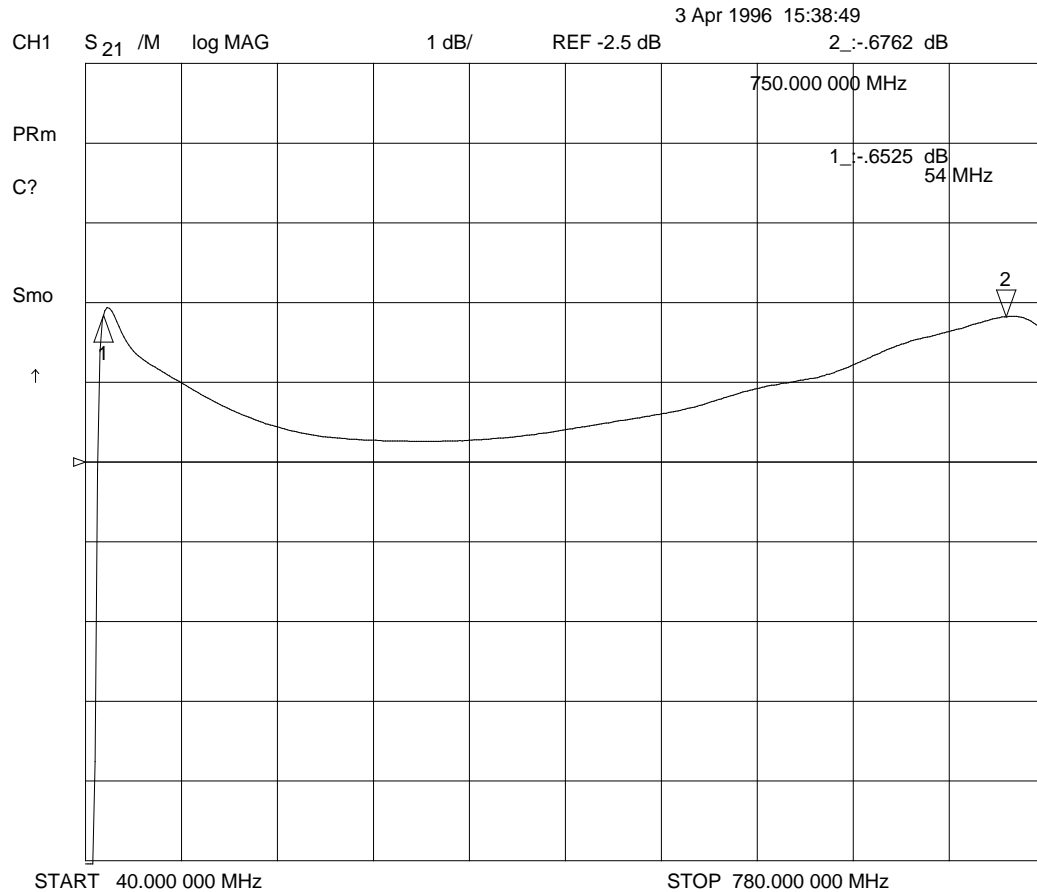

C9 and C8 adjusted to depict peaks at 54 MHz and 750 MHz.

- C9 controls the low frequency peak.
- C8 controls the high frequency peak.
- Fixed low frequency peak at 54 MHz.
- 54 MHz high pass filter.
- Insertion loss is equal to 2 dB.

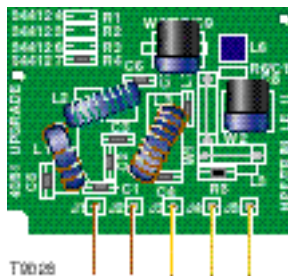

5-Pin Trim Networks Response Plots, Continued

LDP-2NNF-HPF - part number 544127, continued

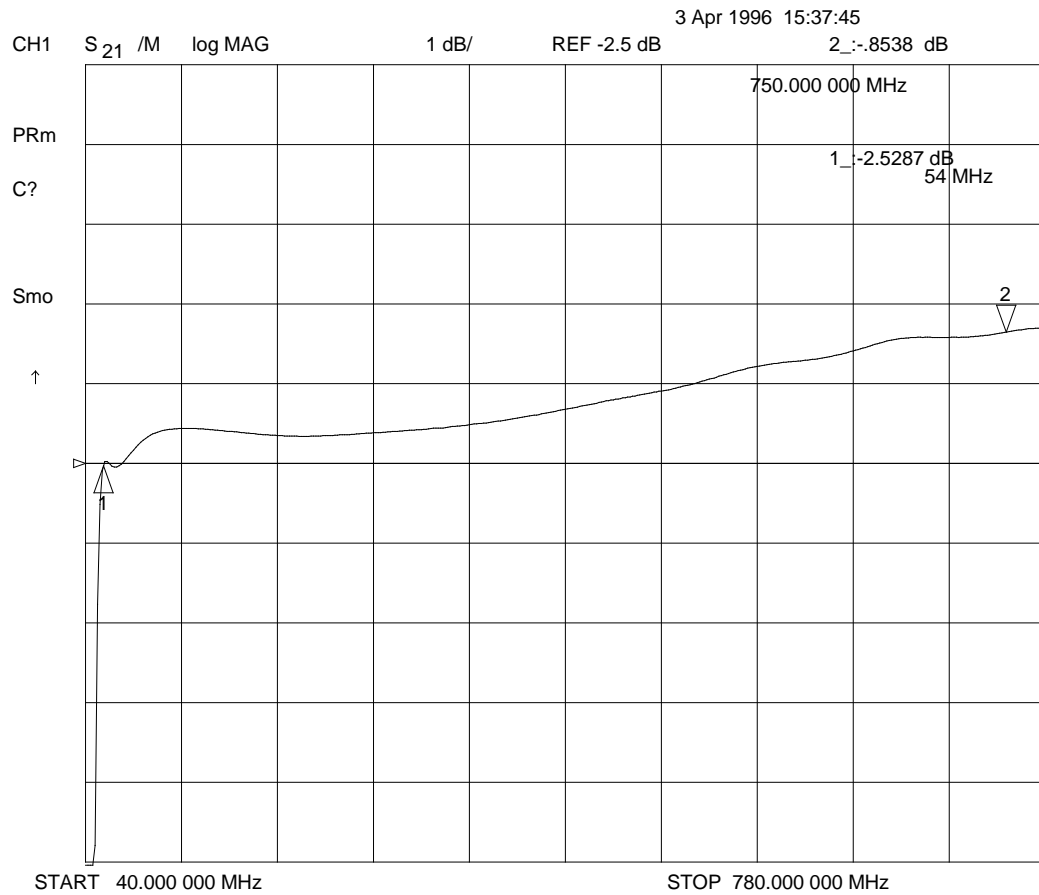

C9 & C8 adjusted to depict minimum peak at 54 MHz and 750 MHz.

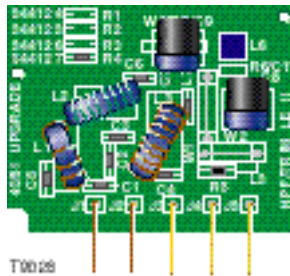

5-Pin Trim Networks Response Plots, Continued

MSD-2NNF - part number 712557*

Mid. Frequency Dual Peak

* Plot also applies to part numbers 589136, 589137 and 589138.

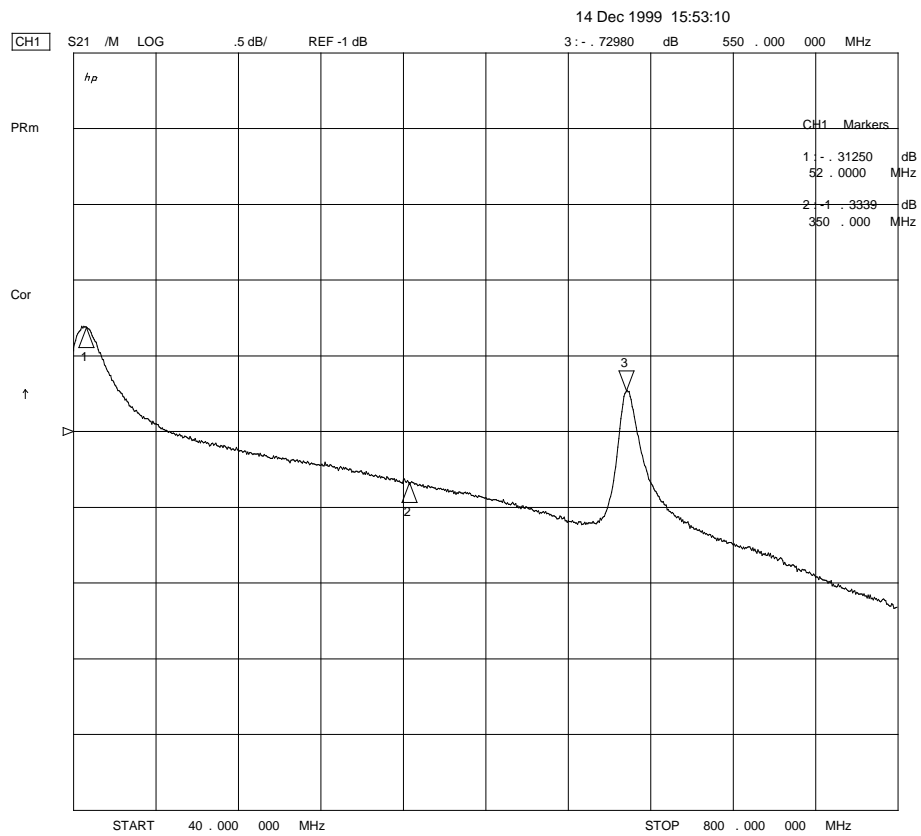

Adjusting C5 changes the high-end frequency peak from 550 MHz to 750 MHz.

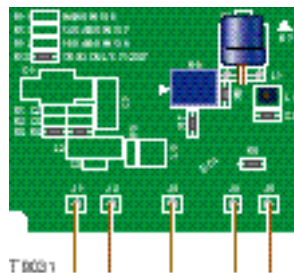

5-Pin Trim Networks Response Plots, Continued

MSD-2NNF - part number 712557, continued

Mid. Frequency Dual Peak

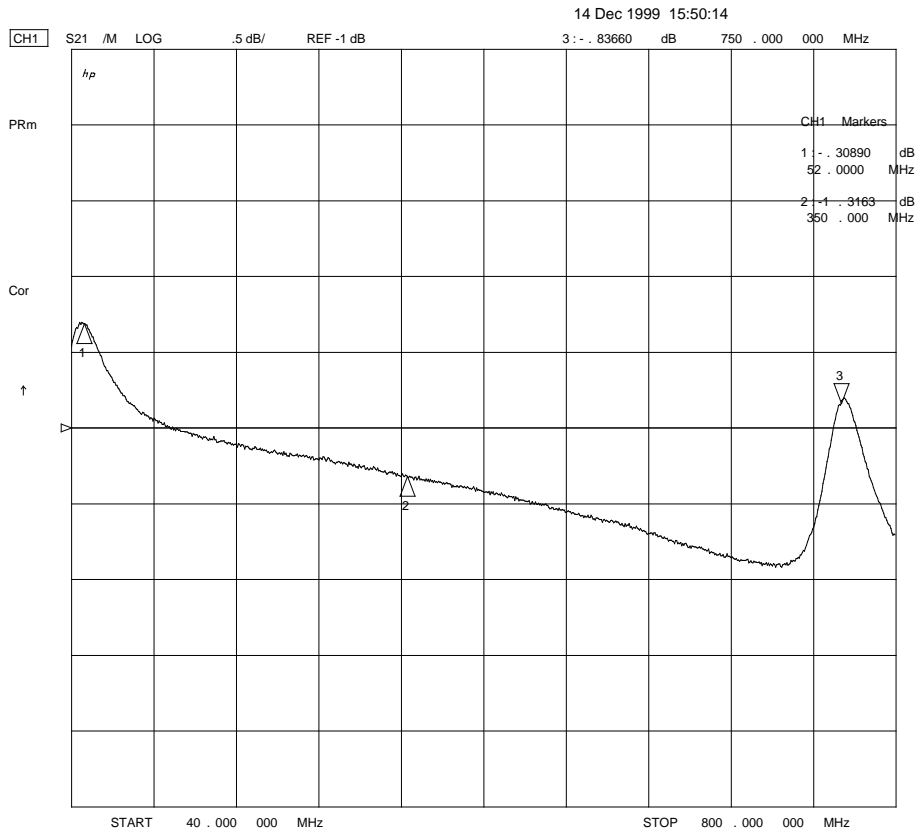

Adjusting C5 changes the high-end frequency peak from 550 MHz to 750 MHz.

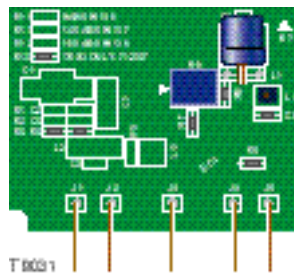

5-Pin Trim Networks Response Plots, Continued

MSD-2NNF - part number 712557, continued

Mid. Frequency Dual Peak

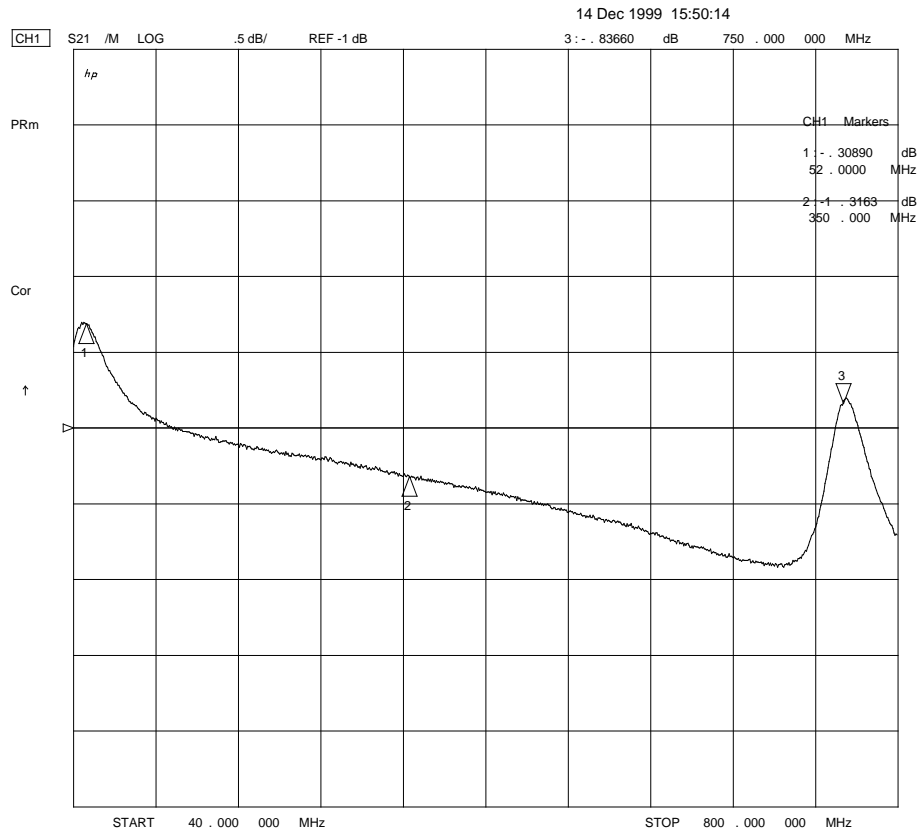

Adjusting R8 changes the depth of the mid-band dip without changing the location of the peaks.

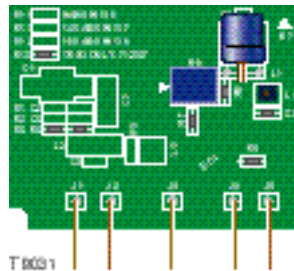

5-Pin Trim Networks Response Plots, Continued

MSD-2NNF - part number 712557, continued

Mid. Frequency Dual Peak

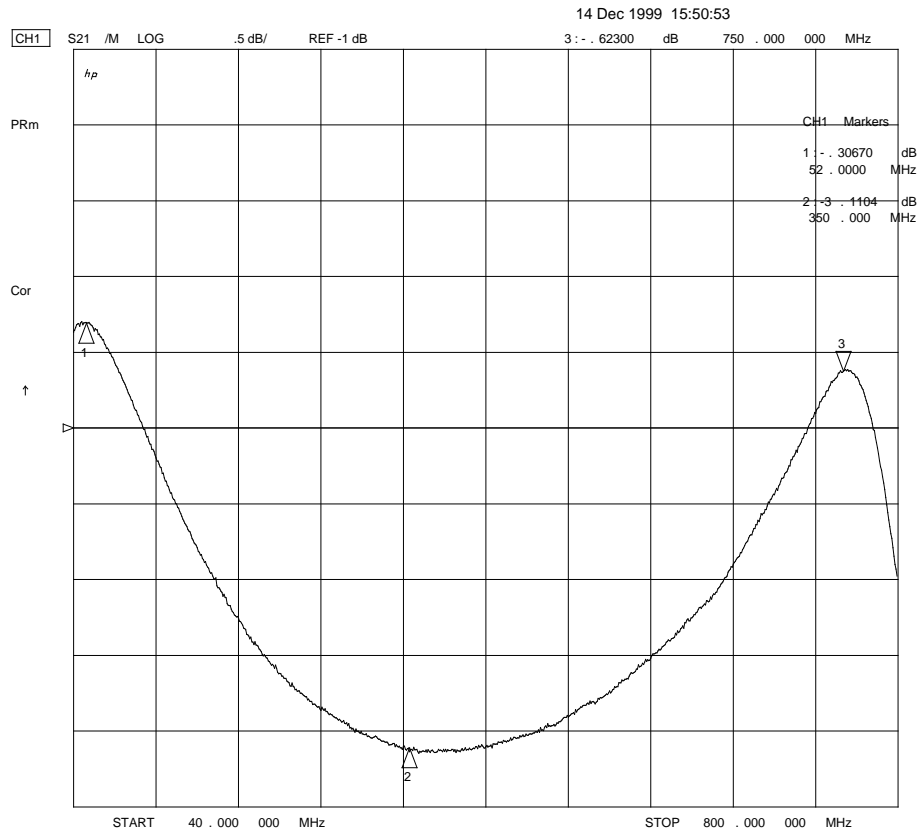

Adjusting R8 changes the depth of the mid-band dip without changing the location of the peaks.

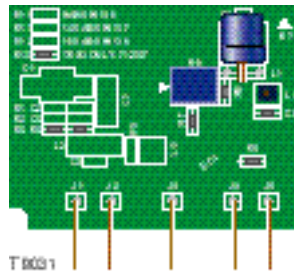

GainMaker Trim Networks Response Plots

GainMaker Trim Networks Part Number

The following table lists the part number and model number for the GainMaker trim networks used in the GMSA and GMLE.

Part Number	Model Number	Description
714446	MSD-1NGF	Mid. Frequency Dual Peak
4021964	HSP-1NGF	High Frequency Single Peak
4022212	MSD-1NGF	High Frequency Dual Peak

GainMaker Trim Networks Response Plots, Continued

MSD-1NGF - part number 714446

Mid. Frequency Dual Peak

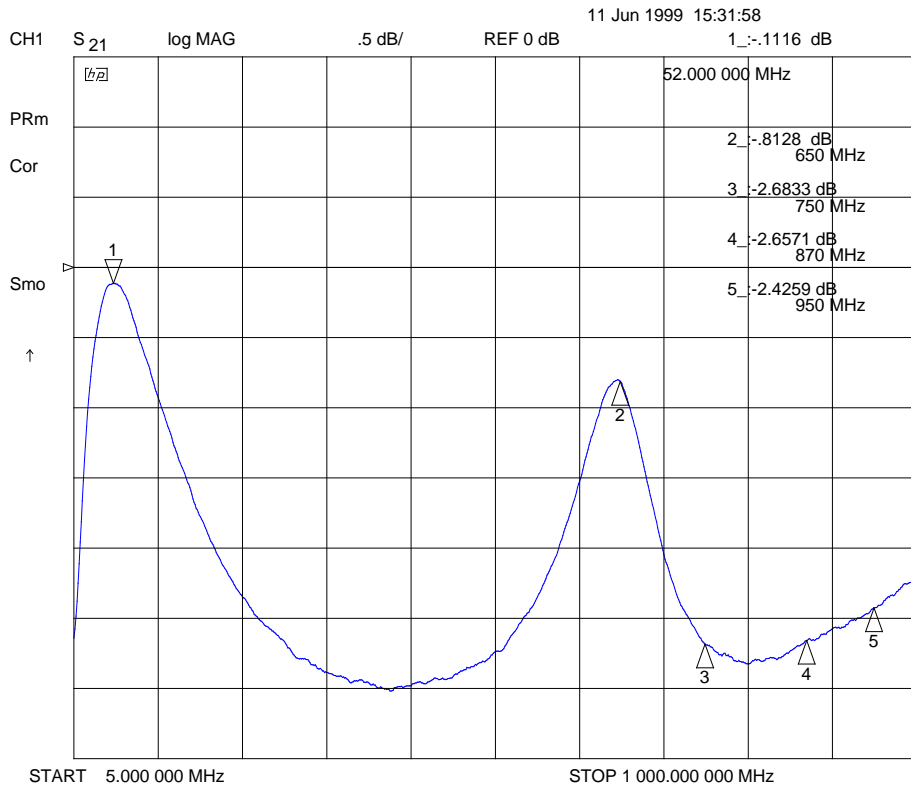

Adjusting C1 changes the high-end frequency peak from 650 MHz to 950 MHz.

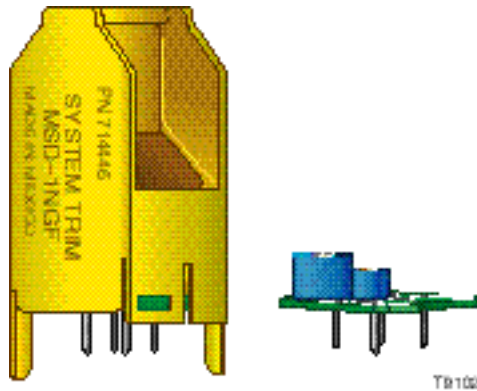

GainMaker Trim Networks Response Plots, Continued

MSD-1NGF - part number 714446, continued

Mid. Frequency Dual Peak

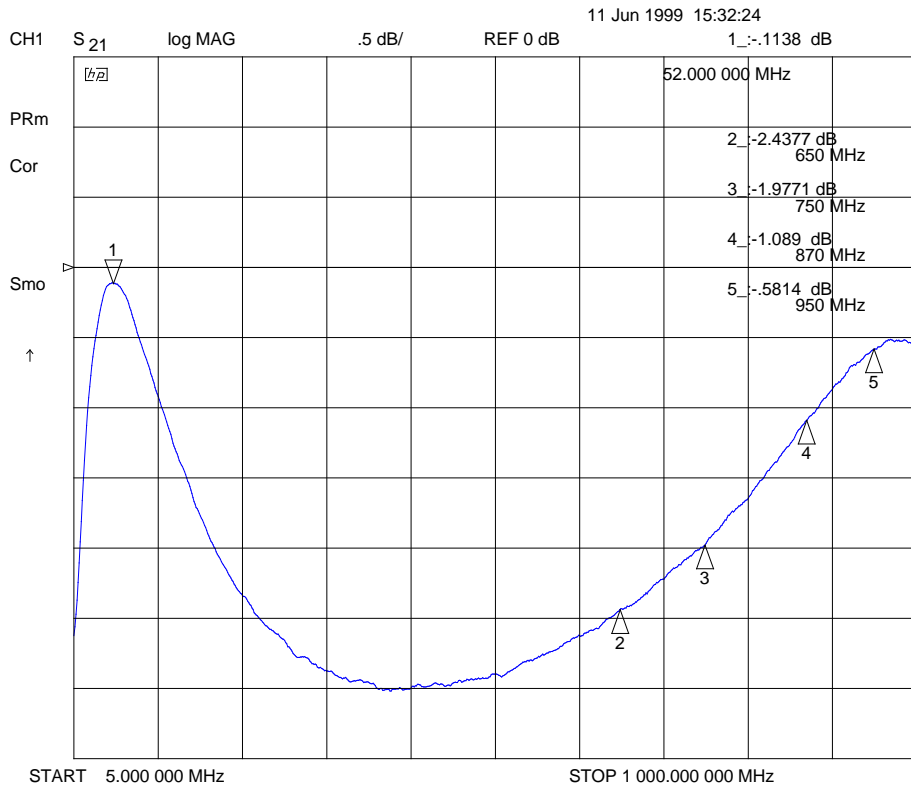

Adjusting C1 changes the high-end frequency peak from 650 MHz to 950 MHz.

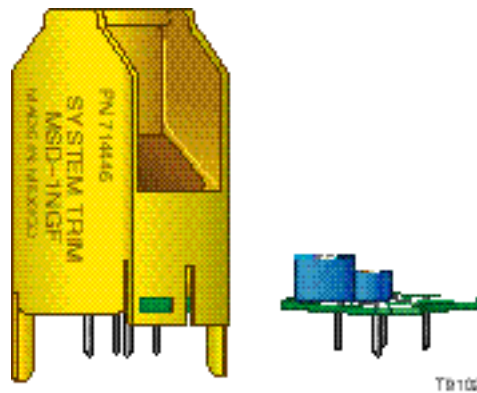

GainMaker Trim Networks Response Plots, Continued

MSD-1NGF - part number 714446, continued

Mid. Frequency Dual Peak

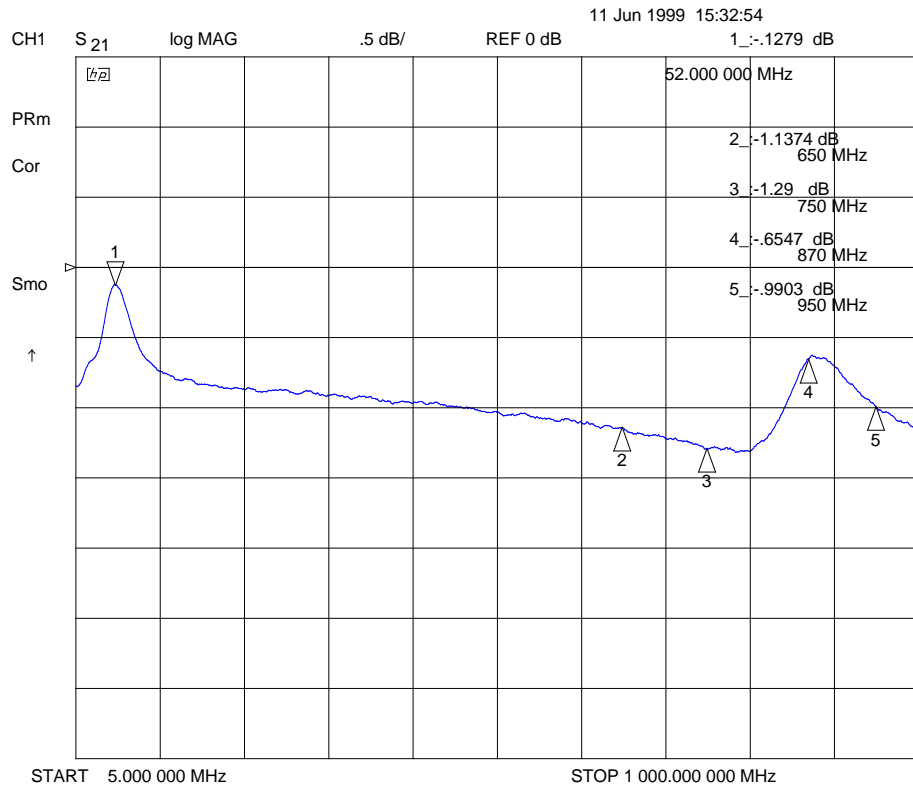

Adjusting R2 changes the depth of the mid-band dip without changing the location of the peaks.

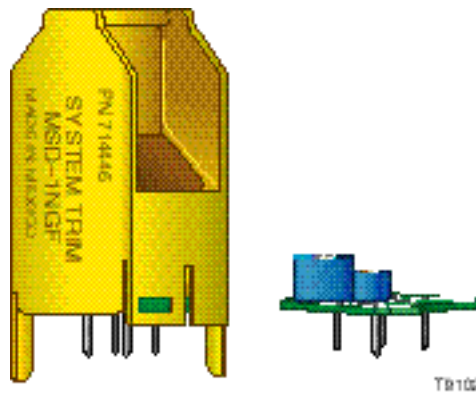

GainMaker Trim Networks Response Plots, Continued

MSD-1NGF - part number 714446, continued

Mid. Frequency Dual Peak

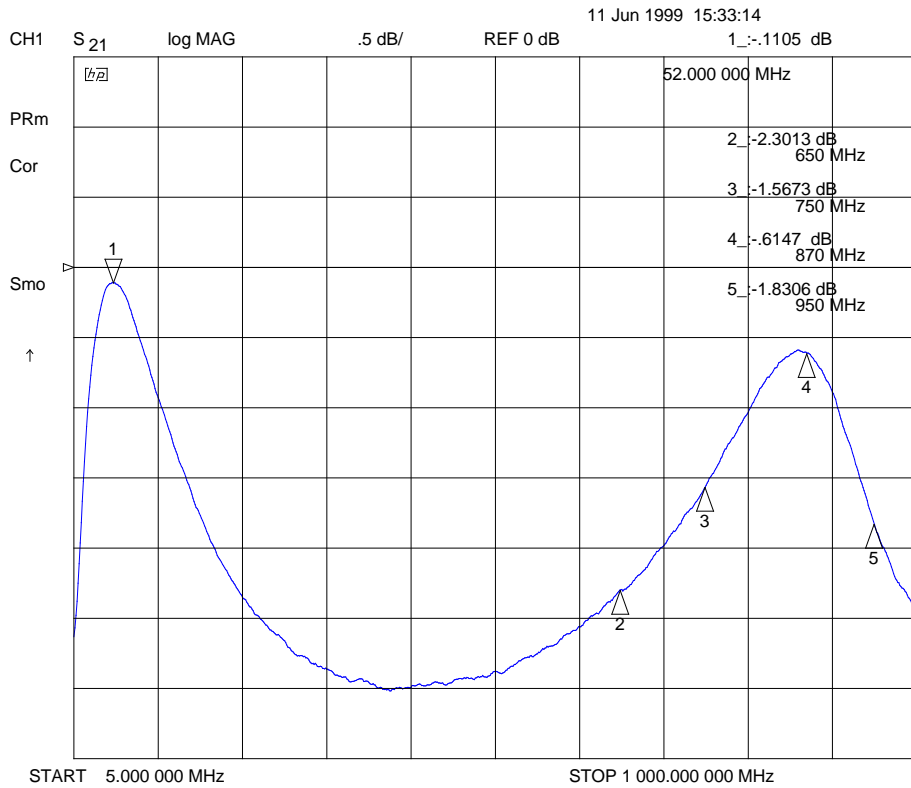

Adjusting R2 changes the depth of the mid-band dip without changing the location of the peaks.

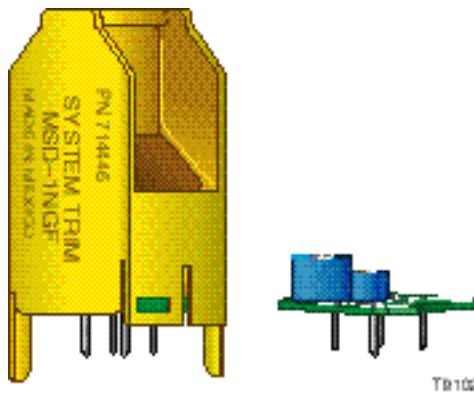

GainMaker Trim Networks Response Plots, Continued

HSP-1NGF - part number 4021964

High Frequency Single Peak

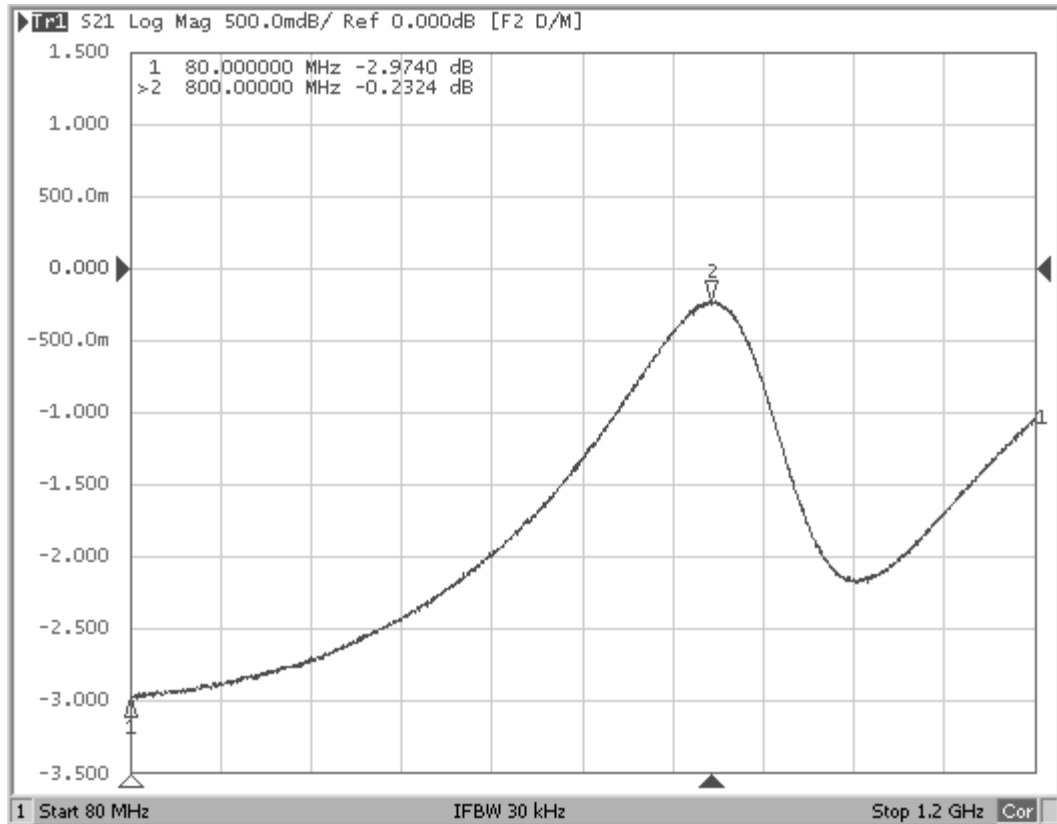

Adjusting C1 changes the high-end frequency peak from 800 MHz to 1.1 GHz.

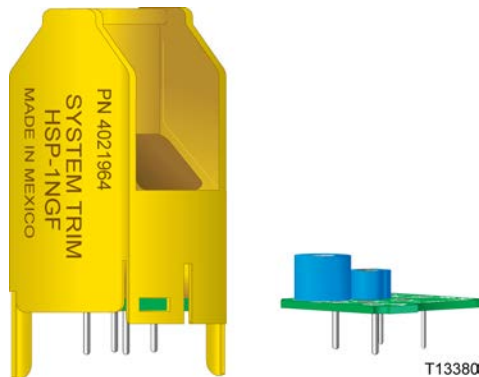

GainMaker Trim Networks Response Plots, Continued

HSP-1NGF - part number 4021964, continued

High Frequency Single Peak

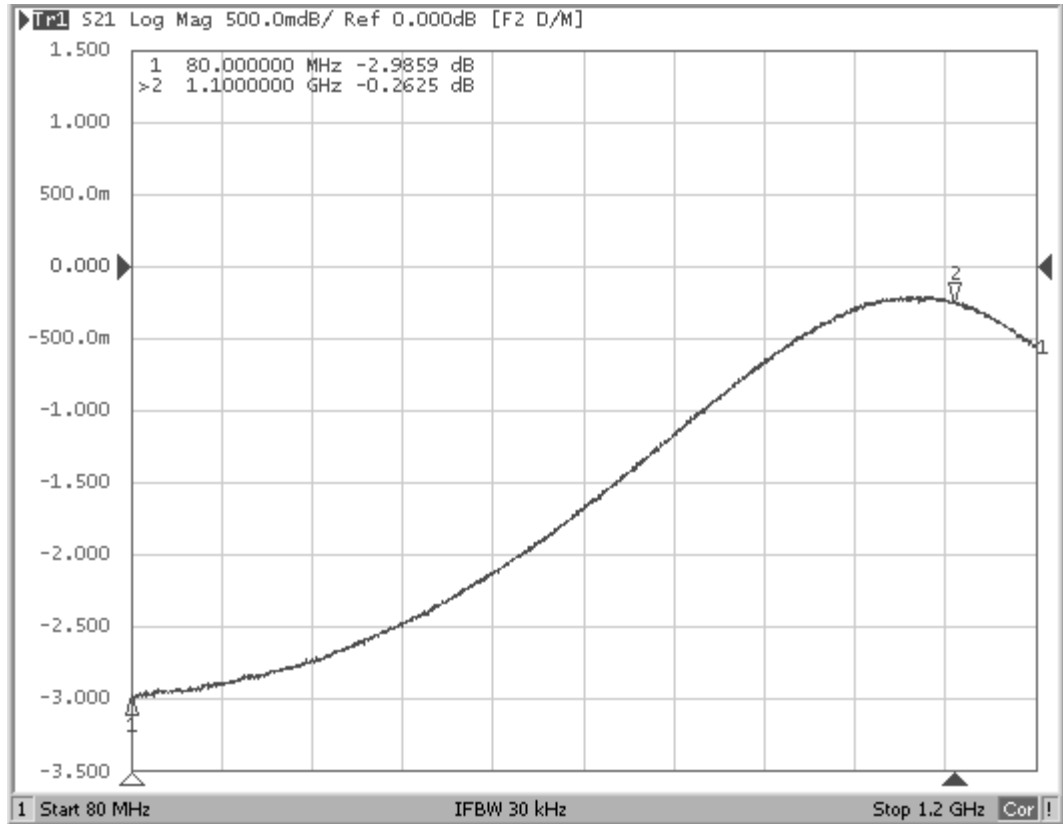

Adjusting C1 changes the high-end frequency peak from 800 MHz to 1.1 GHz.

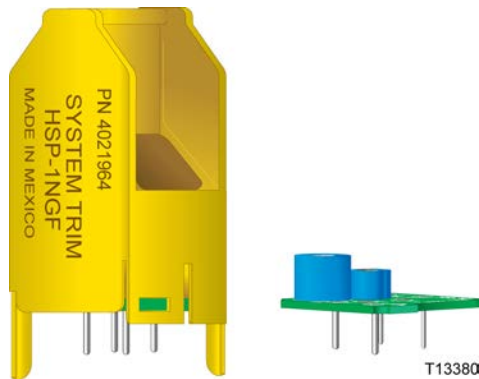

GainMaker Trim Networks Response Plots, Continued

HSP-1NGF - part number 4021964, continued

High Frequency Single Peak

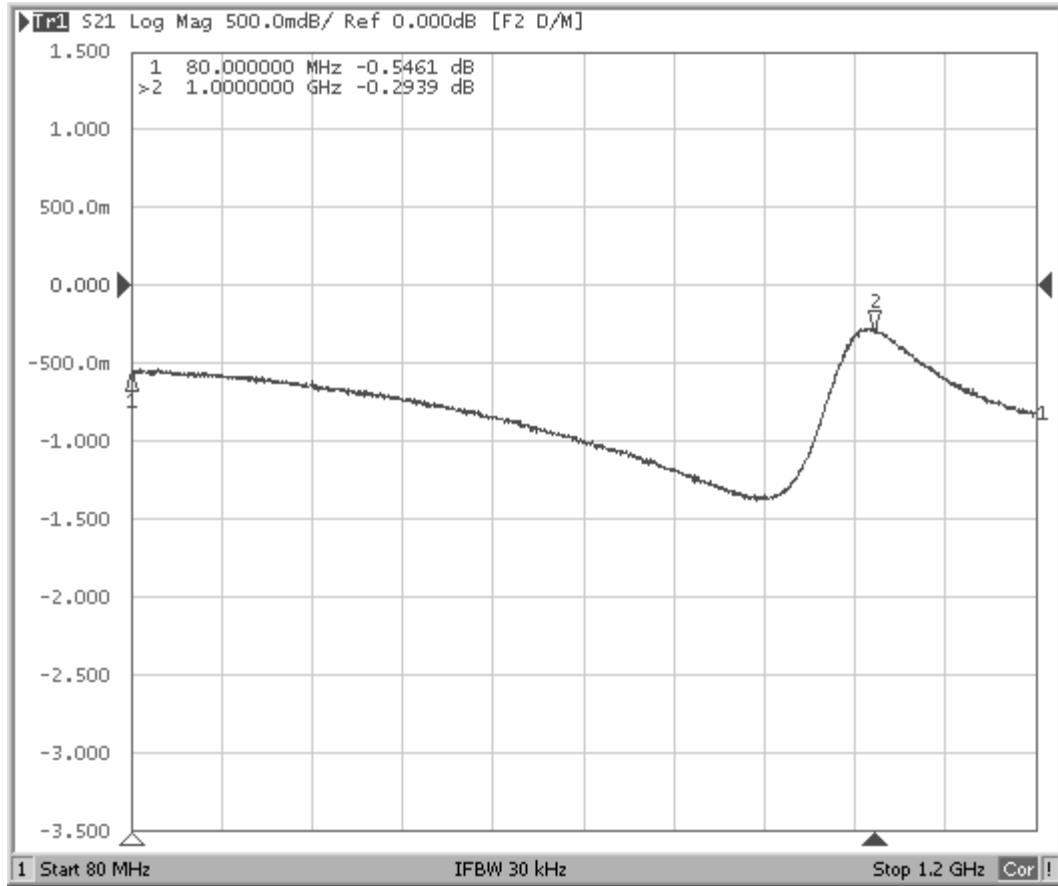

Adjusting R2 changes the depth of the low frequency response without changing the location of the peak.

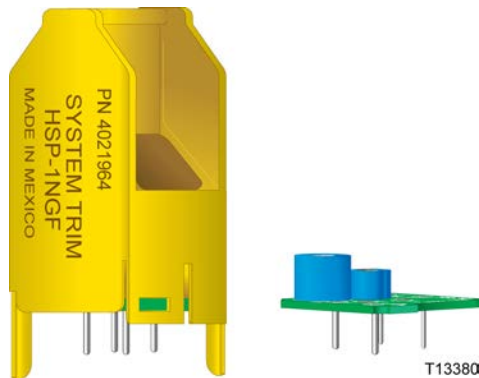

GainMaker Trim Networks Response Plots, Continued

HSP-1NGF - part number 4021964, continued

High Frequency Single Peak

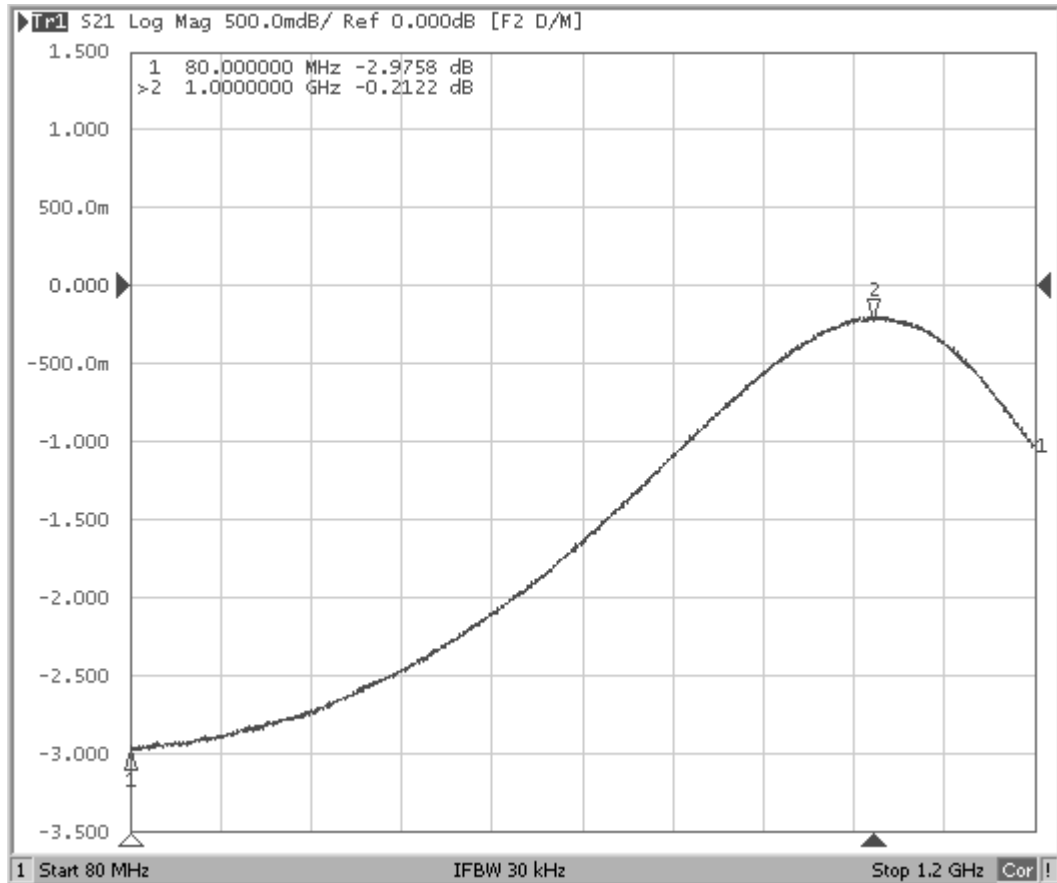

Adjusting R2 changes the depth of the low frequency response without changing the location of the peak.

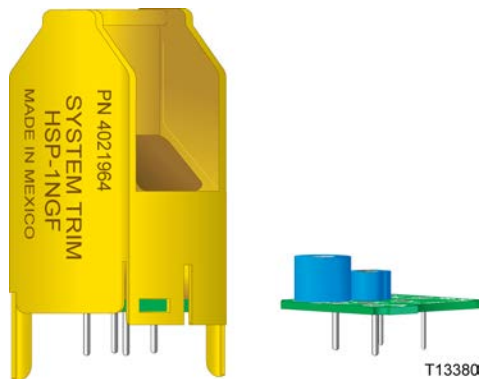

GainMaker Trim Networks Response Plots, Continued

MSD-1NGF - part number 4022212

High Frequency Dual Peak

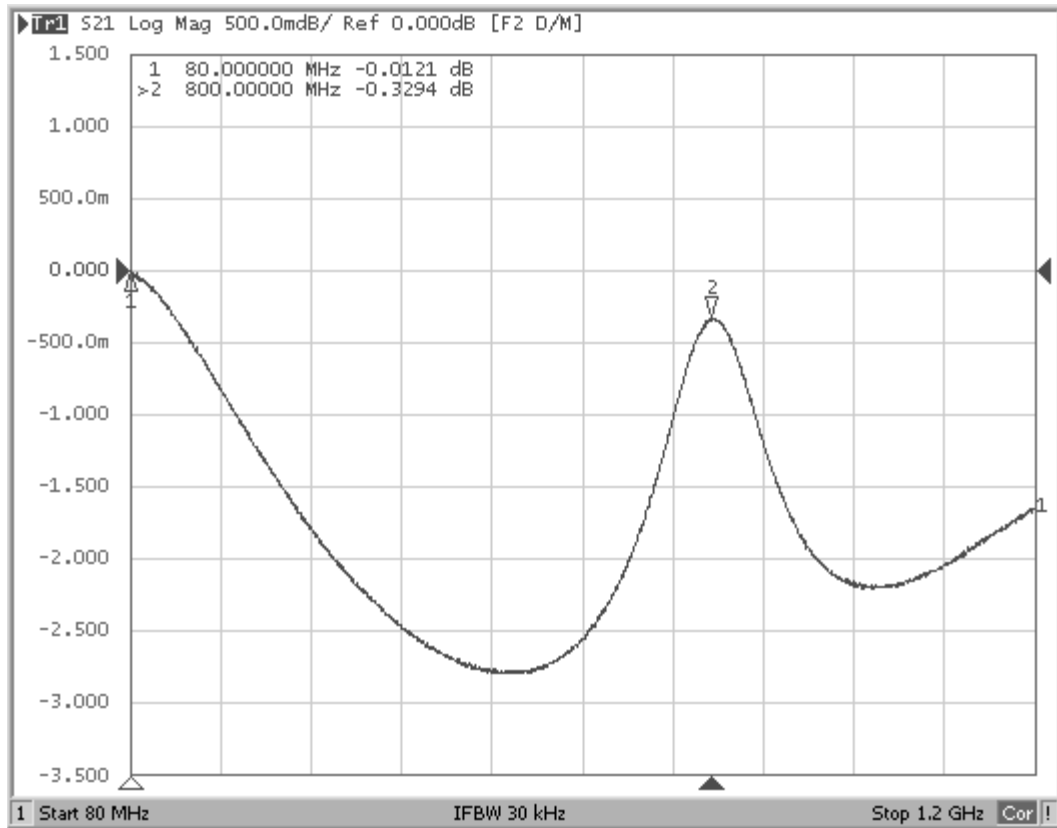

Adjusting C1 changes the high-end frequency peak from 800 MHz to 1.1 GHz.

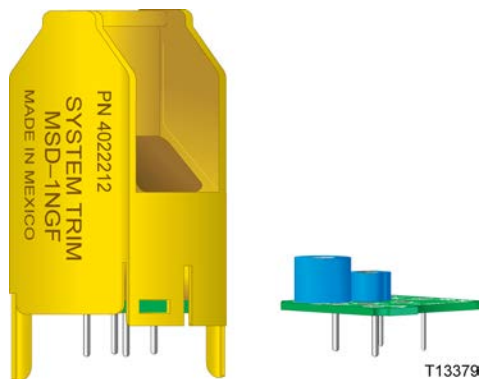

GainMaker Trim Networks Response Plots, Continued

MSD-1NGF - part number 4022212, continued

High Frequency Dual Peak

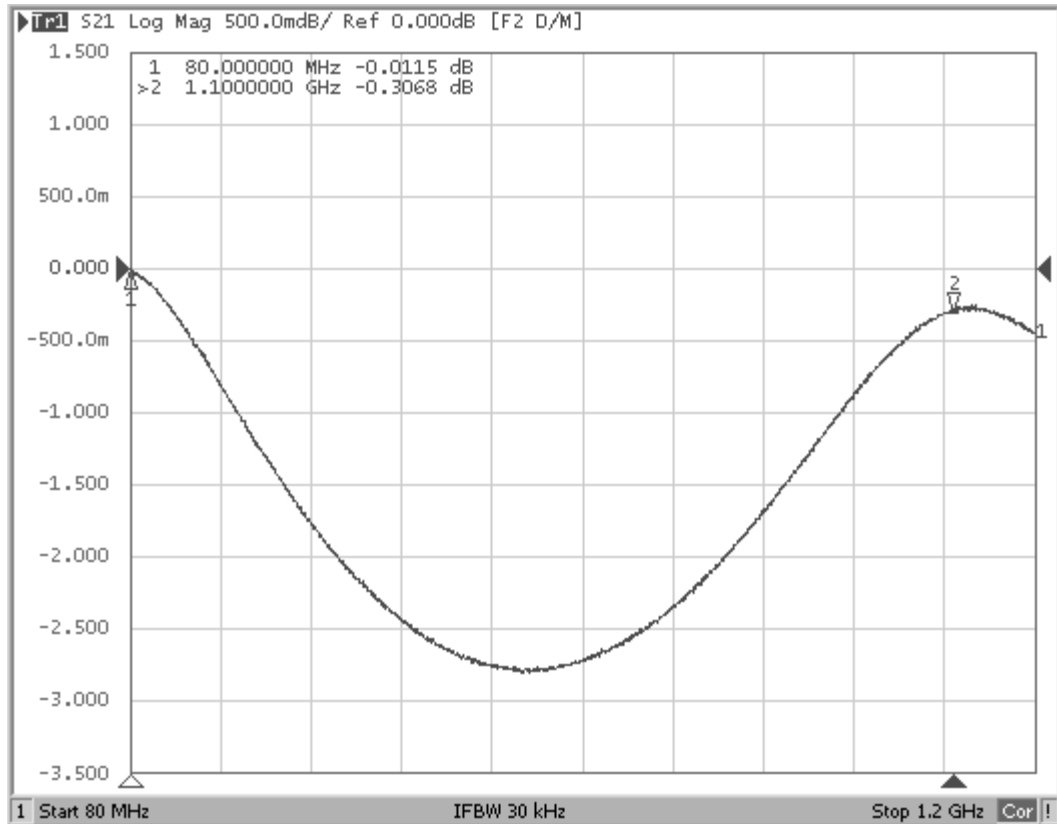

Adjusting C1 changes the high-end frequency peak from 800 MHz to 1.1 GHz.

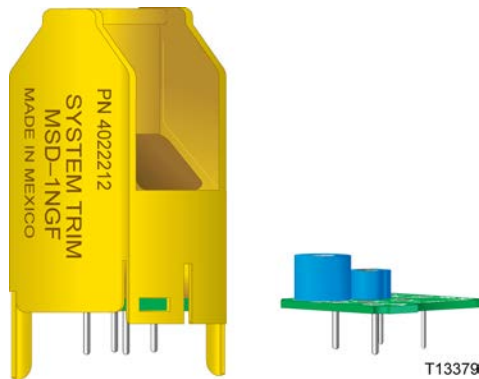

GainMaker Trim Networks Response Plots, Continued

MSD-1NGF - part number 4022212, continued

High Frequency Dual Peak

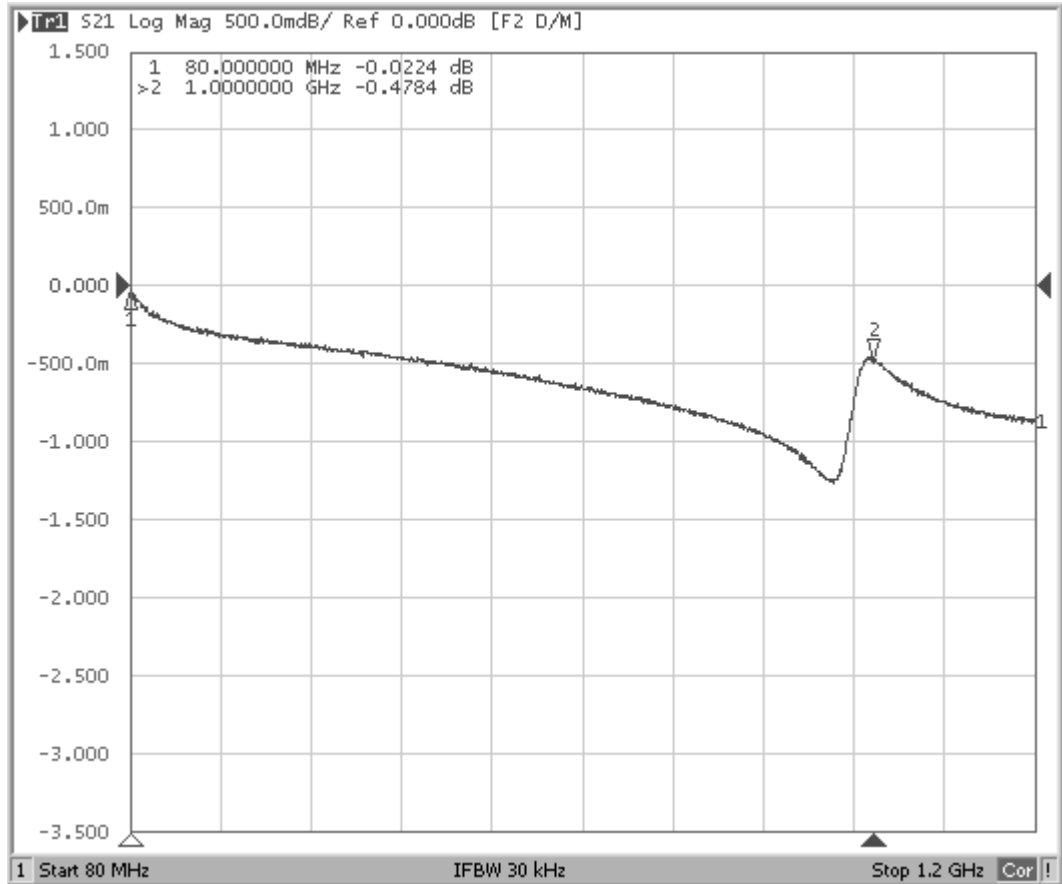

Adjusting R2 changes the depth of the mid-band dip without changing the location of the peaks.

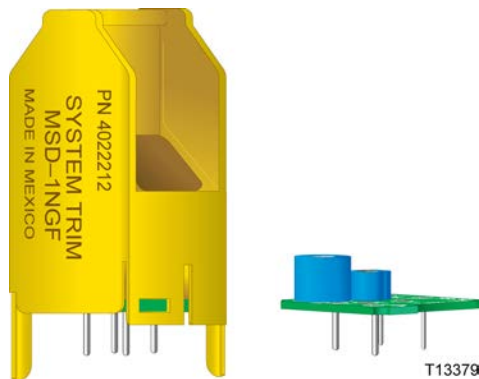

GainMaker Trim Networks Response Plots, Continued

MSD-1NGF - part number 4022212, continued

High Frequency Dual Peak

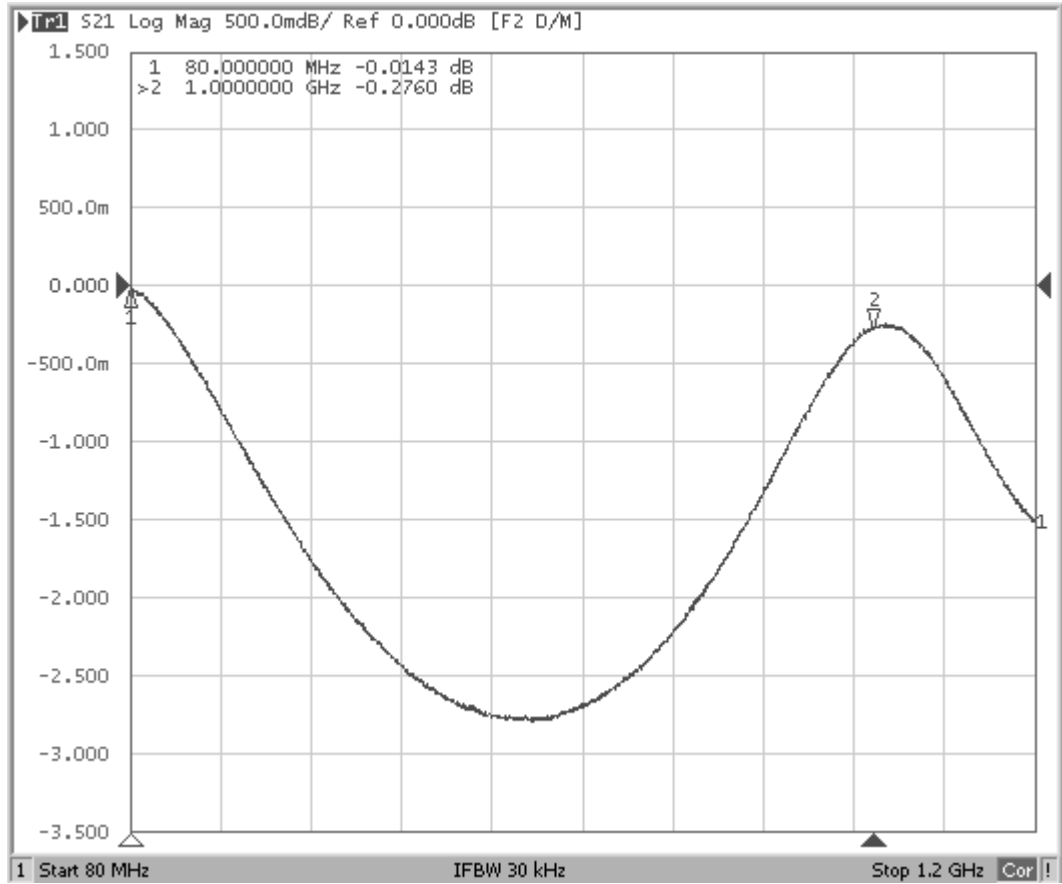

Adjusting R2 changes the depth of the mid-band dip without changing the location of the peaks.

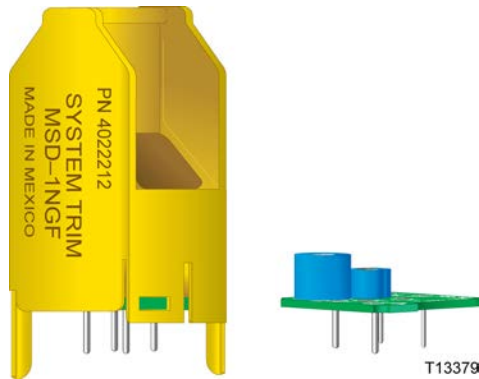

3-Pin Trim Networks Response Plots

550 MHz Line Extender II Trim Networks Part Numbers

The following table lists the part numbers and model numbers for 3-pin trim networks used in the 550 MHz LEII.

Part Number	Model Number	Description	Module
501967	LDP-2SMF	Low Frequency Dual Peak	550 LEII
502273	MDP-3SMF	Mid. Frequency Dip/Peak	550 LEII

3-Pin Trim Networks Response Plots, Continued

LDP-2SMF - part number 501967

Low Frequency Dual Peak

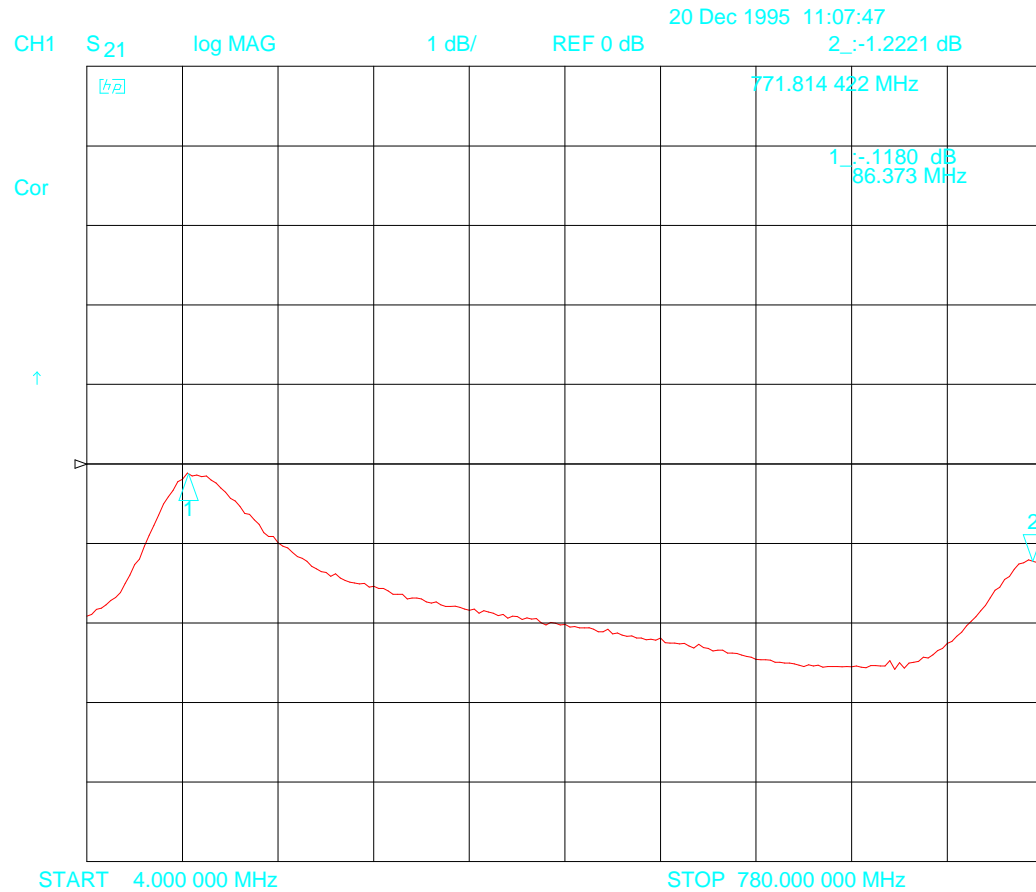

C1 and C2 adjusted to depict the peak's maximum range.

C1 varies the frequency of the high peak between 236 MHz and 780 MHz.

C2 varies the frequency of the low peak between 36 MHz and 90 MHz.

Average insertion loss is 2 dB.

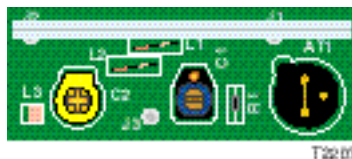

3-Pin Trim Networks Response Plots, Continued

LDP-2SMF - part number 501967, continued

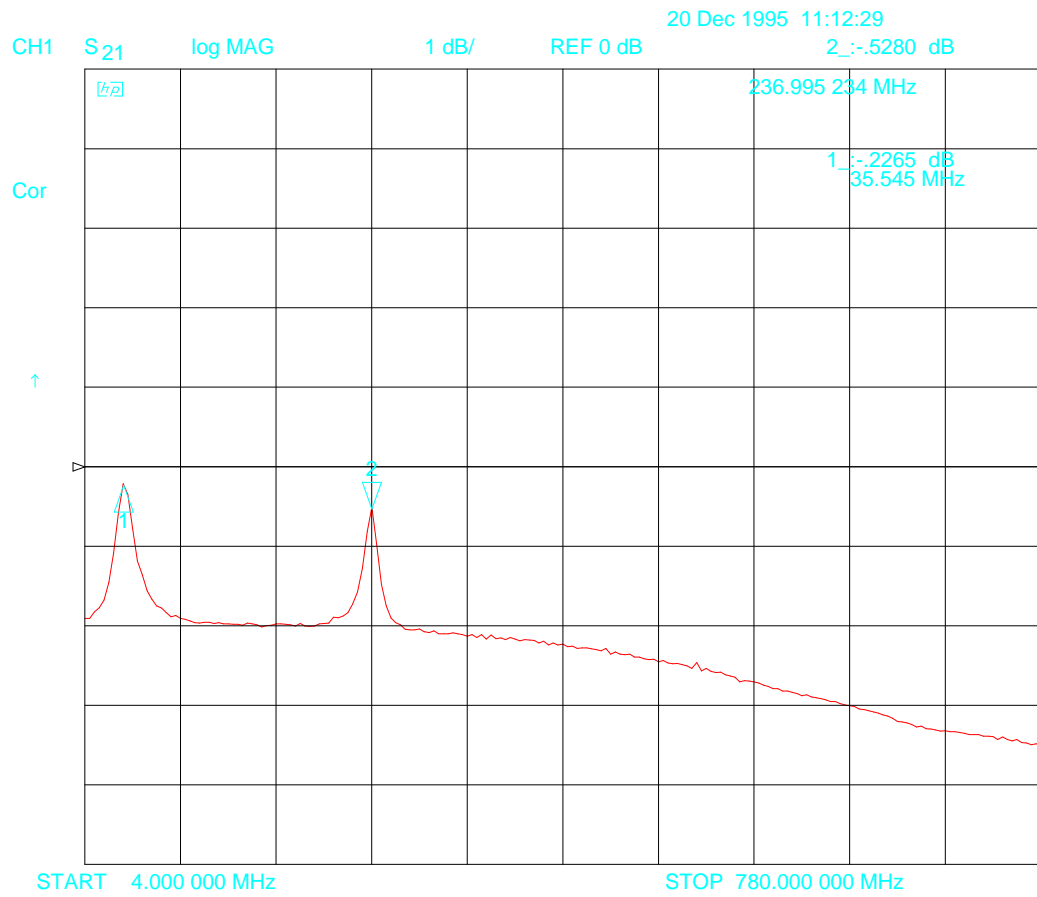

C1 and C2 adjusted to depict the peak's minimum range.

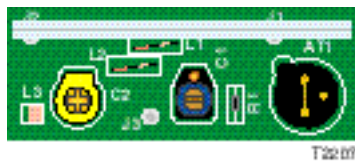

3-Pin Trim Networks Response Plots, Continued

MDP-3SMF - part number 502273

Mid. Frequency Dual / Peak

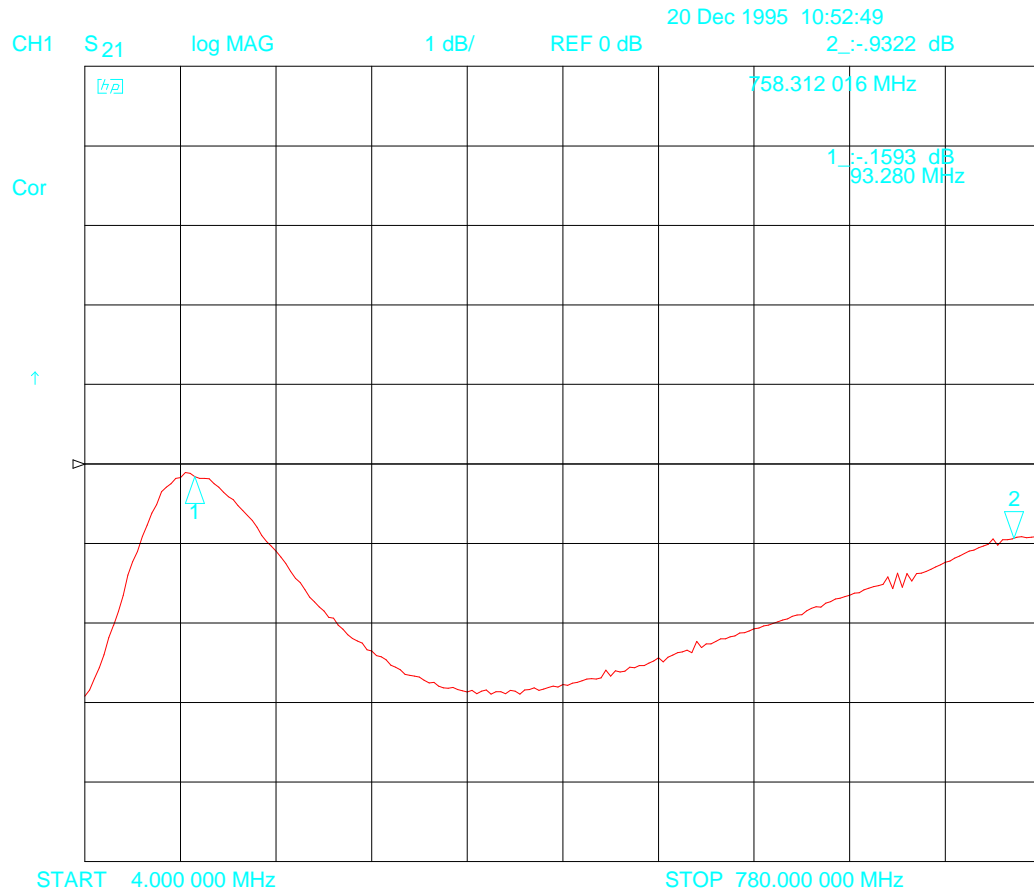

C1 and C2 adjusted to depict the peak's maximum range.

C1 varies the frequency of the high peak between 215 MHz and 780 MHz.

C2 varies the frequency of the low peak between 34 MHz and 88 MHz.

Insertion loss is equal to 3 dB.

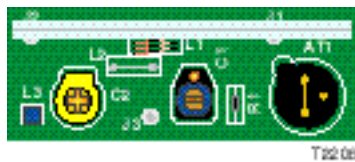

3-Pin Trim Networks Response Plots, Continued

MDP-3SMF - part number 502273, continued

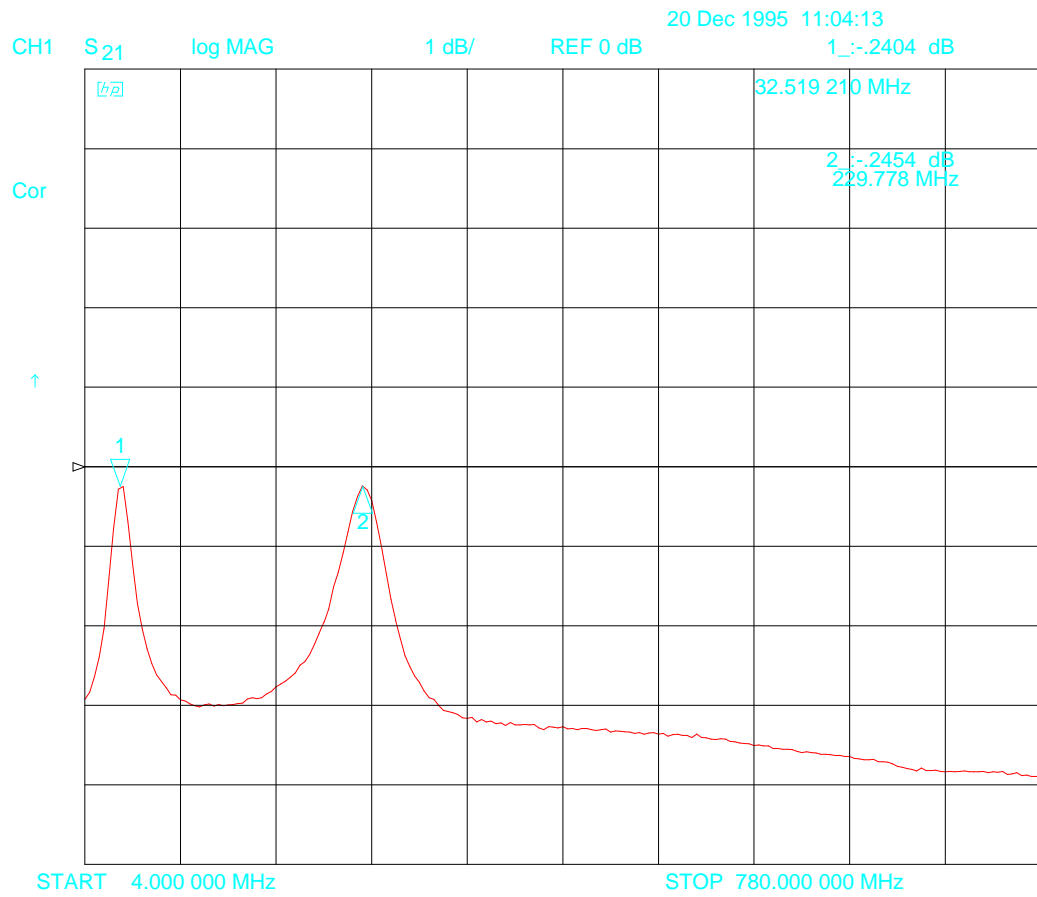

C1 and C2 adjusted to depict the peak's minimum range.

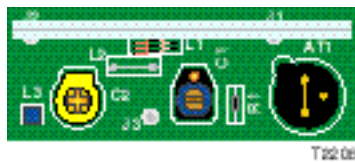

Card Trim Networks Response Plots

550 MHz Line Extender I Trim Networks Part Numbers

The following table lists the part numbers and model numbers for card trim networks used in the 550 MHz LEI.

Part Number	Model Number	Description	Module
501967	LDP-2SMF	Low Frequency Dual Peak	550 LEII

Card Trim Networks Response Plots, Continued

LDP-2SLF - part number 372728

Low Frequency Dual Peak

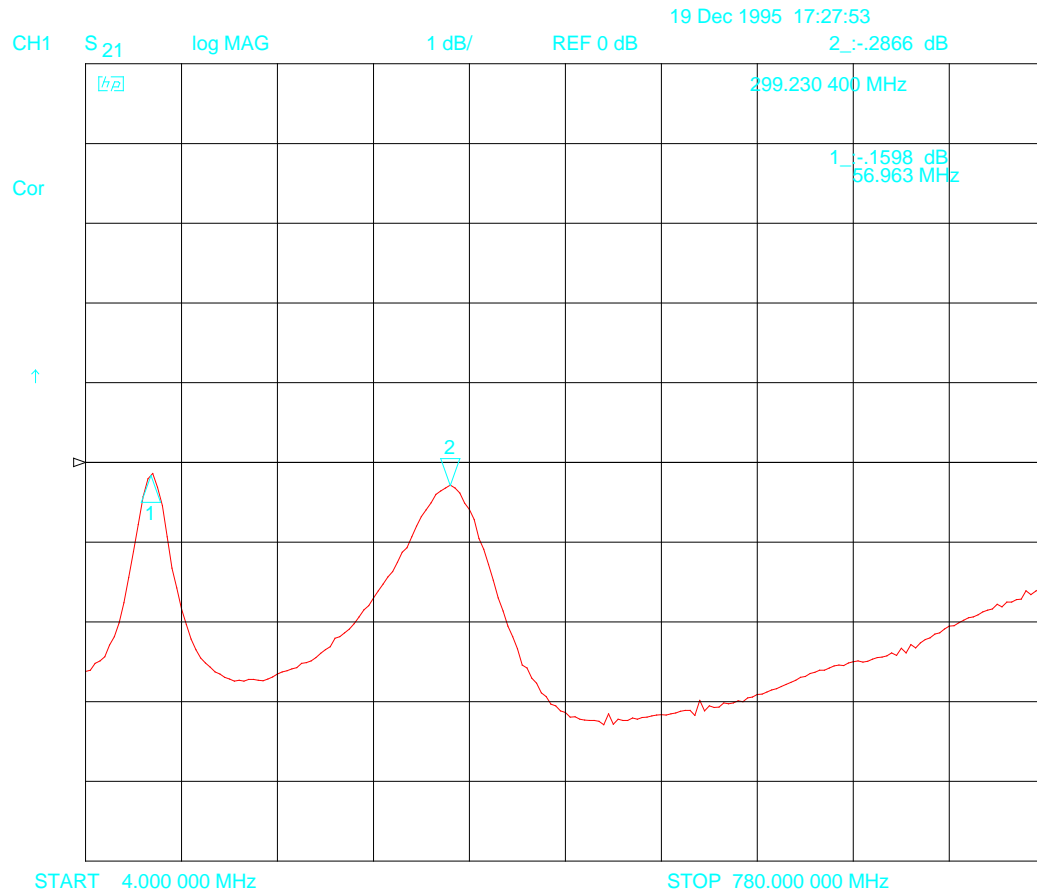

C1 and C2 adjusted to depict the peak's minimum range.

C1 varies the frequency of the high peak between 305 MHz and 530 MHz.

C2 varies the frequency of the low peak between 57 MHz and 141 MHz.

Average insertion loss is 2 dB.

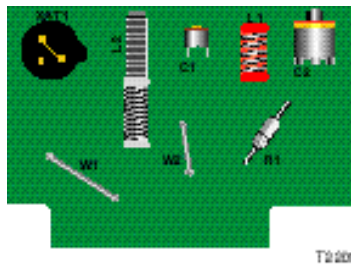

Card Trim Networks Response Plots, Continued

LDP-2SLF - part number 372728, continued

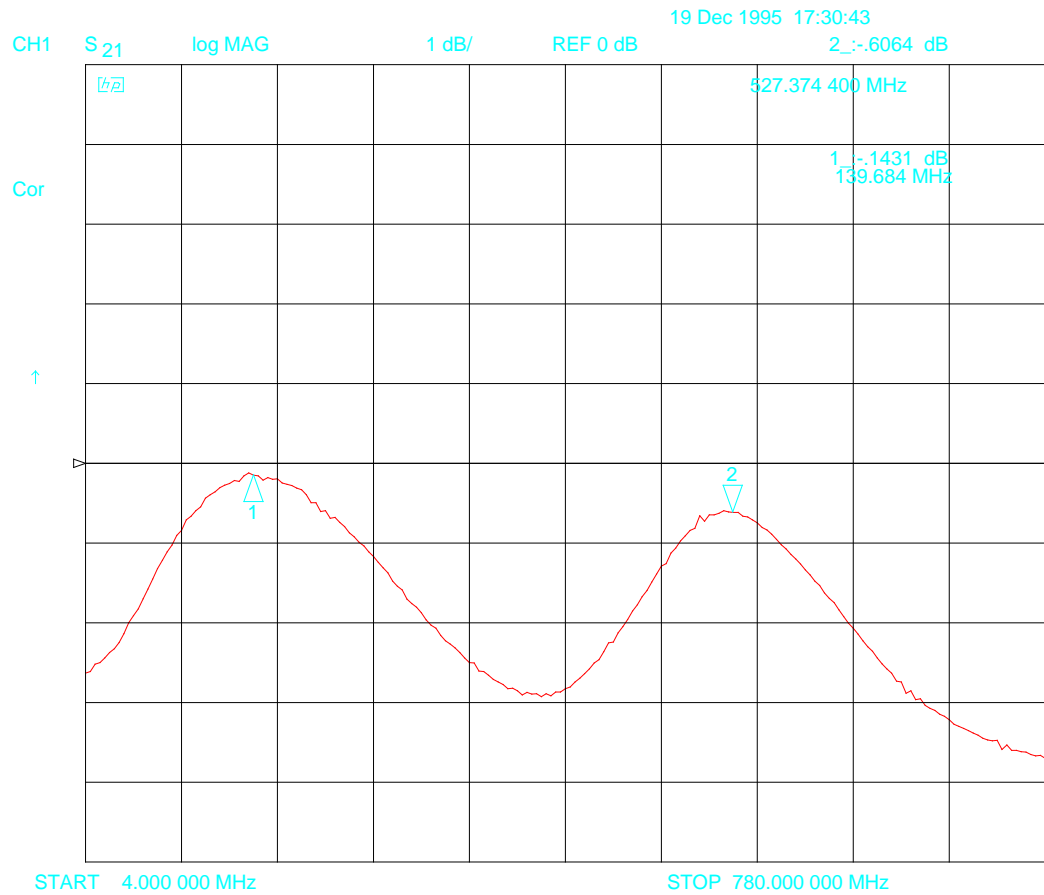

C1 and C2 adjusted to depict the peak's maximum range.

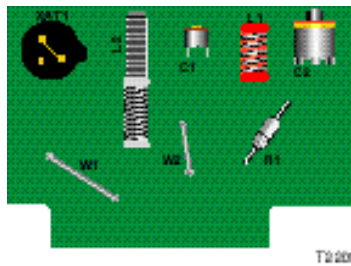

Chapter 4

Customer Information

Customer Information

If You Have Questions

If you have technical questions, call Cisco Services for assistance. Follow the menu options to speak with a service engineer.

Access your company's extranet site to view or order additional technical publications. For accessing instructions, contact the representative who handles your account. Check your extranet site often as the information is updated frequently.

Glossary

Term, Acronym, Abbreviation	Meaning
A	Ampere (amp) is the unit of measure for electrical current
AC	Alternating current
AGC	Automatic Gain Control
AUX	Auxiliary
Baud (Bd)	The number of times a state change occurs per second on a communications channel.
Bps	Bits per second. The total number of bits sent in a second of time.
BPSK	Binary phase shift keying
BW	bandwidth
CCW	Counterclockwise
C/N or CNR	Carrier-to-noise ratio
CW	Continuous wave
DA	Distribution Amplifier
dB	Decibel
dBc	Decibels of gain relative to a reference carrier
dBm	Decibels relative to 1 milliwatt
dB _i	Decibels of gain relative to an isotropic radiator
dB _u V	Decibels relative to 1 microvolt
dBW	Decibels relative to 1 watt
dBmV	Decibels relative to 1 millivolt
DC	Direct current or directional coupler
DPU	Digital processing unit
EC	The European Community

Glossary, Continued

EPROM	Erasable Programmable Read-Only Memory
EQ	Equalizer
Equalization	The process of compensating for an undesired result. For example, equalizing tilt in a distribution system.
Ext	External
FITT	Forward Intermediate Terminating Trunk
FM	Frequency modulation
Forward	Signal direction from the headend to the set-top terminal.
Frequency	The number of similar shapes in a unit of time. For example, the number of sine waves moving past a fixed point in a second.
FSM	Field strength meter
FSK	Frequency-shift keying
ft-lb	Foot-pound
FTP	File Transfer Protocol
GaAs FET	Gallium arsenide field effect transistor
GMLE	GainMaker Line Extender
GMSA	GainMaker System Amplifier
Hertz	A unit of frequency equal to one cycle per second.
I/C	Induction/capacitance
I/O	Input/output
IC	Integrated circuit
IDR	Intermediate Data Rate
IEC	International Electrotechnical Commission
IF	Intermediate frequency
in -lb	Inch-pound-
LEI, LEII, LEIII	Line Extender I, Line Extender II, Line Extender III

Glossary, Continued

LED	Light emitting diode
Mbps	Megabits per second
N/C	Not connected
Nanosecond	1 thousandth of a microsecond
Nm	Newton meter
NIU	Network Interface Unit
OEM	Original equipment manufacturer
OOB	Out of band
PA	Power amplifier
PCB	Printed circuit board
PDI	Pressure Differential Indicator
PROM	Programmable Read Only Memory
PWB	Printed wiring board
PWR	Power
QAM	Quadrature amplitude modulation
QPSK	Quadrature phase-shift keying
R/C	Resistance/capacitance
RC	Reverse conditioner
RCVR	Receiver
Reverse or return	Signal flow direction toward the headend
RF	Radio frequency
RMA	Return material authorization
RMS	Root-mean square
RX	Receive
SAI, SAIL, SAIII	System Amplifier I, System Amplifier II, System Amplifier III

Glossary, Continued

SA	Spectrum analyzer
SAM	Signal analysis meter
SMC	Status monitoring and control
SM	Status monitor
S/N or SNR	Signal-to-noise ratio
SNMP	Simple Network Management Protocol
Torque	Force applied to bolt or screw to tighten the device.
TS	Transport stream
TX	Transmit
UPS	Uninterruptible power supply
UTP	Unshielded twisted pair
V	Volt
V AC	Volts alternating current
V DC	Volts direct current
VBR	Variable bit rate
W	Watts

Index

3

3-pin trim networks response plots

501967, 3-51

502273, 3-53

3-Pin Trim Networks Response Plots, 3-50

5

5-pin trim networks response plots

276754, 3-9

381101, 3-11

381102, 3-13

500221, 3-5

500300, 3-7

501769, 3-15

506506, 3-3

536640, 3-18

536644, 3-19

541635, 3-21

541636, 3-23

541637, 3-25

544125, 3-27

544126, 3-29

544127, 3-31

5-Pin Trim Networks Response Plots, 3-2

A

Automatic Gain Control (AGC), 2-21

B

Bench sweeping, 1-3

C

card trim networks response plots

372728, 3-57

D

Dip Trim Networks, 1-1

F

Forward Input EQ, 2-20

forward input pad, 2-20

Forward Trim/Pad, 2-10

frequency response

defined, 1-1

G

GainMaker trim networks response plots

4021964, 3-42

4022212, 3-46

712557, 3-33

714446, 3-38

GainMaker Trim Networks Response Plots,
3-37

I

install a trim network in a GMLE, 2-16

installing a trim network in a GainMaker
System Amplifier, 2-9

installing a trim network in a GMLE
system trim, 2-16

interstage network, 2-24

interstage pad, 2-21

J

JUMPER OR TRIM PAD, 2-14

L

Low Frequency Peak, 3-31

M

Mid. Frequency Dip, 3-29

Mid. Frequency Dual Peak, 3-33

N

Name Structures, 1-5

Index, Continued

- O
 - 544126, 2-6
 - 544127, 2-6
- P
 - 712557, 2-3
 - 714446, 2-4
 - Trim Network Response Characteristics
 - Insertion Loss, 1-3
 - Trim Networks Response Characteristics
 - Frequency Control, 1-3
 - Trim Networks Response Characteristics
 - Amplitude Control, 1-3
- R
 - reverse EQ, 2-20
 - Reverse Input Pad, 2-20
 - reverse output pad, 2-20
- S
 - Surge Protector, 2-20
 - system trim, 2-9
- T
 - trim, 2-12
 - Trim Network Illustrations
 - 276754, 2-2
 - 372728, 2-8
 - 381101, 2-2
 - 381102, 2-3
 - 4021964, 2-4
 - 4022212, 2-4
 - 500221, 2-2
 - 500300, 2-2
 - 501769, 2-3
 - 501967, 2-7
 - 502273, 2-7
 - 506506, 2-2
 - 536640, 2-3
 - 536644, 2-3
 - 541635, 2-5
 - 541636, 2-5
 - 541637, 2-5
 - 544125, 2-5
- V
 - variable resistor, 1-3



Cisco Systems, Inc.
5030 Sugarloaf Parkway, Box 465447
Lawrenceville, GA 30042

678 277-1120
800 722-2009
www.cisco.com

This document includes various trademarks of Cisco Systems, Inc. Please see the Notices section of this document for a list of the Cisco Systems, Inc. trademarks used in this document.

Product and service availability are subject to change without notice.

© 2008, 2012 Cisco and/or its affiliates. All rights reserved.

August 2012 Printed in USA

Part Number 741338 Rev D