



Prisma II bdr 4:1 Redundant Transmit Processor Installation and Operation Guide







For Your Safety

Explanation of Warning and Caution Icons



Avoid personal injury and product damage! Do not proceed beyond any symbol until you fully understand the indicated conditions.

The following warning and caution icons alert you to important information about the safe operation of this product:

-  You may find this symbol in the document that accompanies this product. This symbol indicates important operating or maintenance instructions.
-  You may find this symbol affixed to the product. This symbol indicates a live terminal where a dangerous voltage may be present; the tip of the flash points to the terminal device.
-  You may find this symbol affixed to the product. This symbol indicates a protective ground terminal.
-  You may find this symbol affixed to the product. This symbol indicates a chassis terminal (normally used for equipotential bonding).
-  You may find this symbol affixed to the product. This symbol warns of a potentially hot surface.
-  You may find this symbol affixed to the product and in this document. This symbol indicates an infrared laser that transmits intensity-modulated light and emits invisible laser radiation or an LED that transmits intensity-modulated light.

Important

Please read this entire guide. If this guide provides installation or operation instructions, give particular attention to all safety statements included in this guide.

Notices

Trademark Acknowledgments

Cisco and the Cisco logo are trademarks or registered trademarks of Cisco and/or its affiliates in the U.S. and other countries. To view a list of cisco trademarks, go to this URL: www.cisco.com/go/trademarks.

Third party trademarks mentioned are the property of their respective owners. The use of the word partner does not imply a partnership relationship between Cisco and any other company. (1110R)

Publication Disclaimer

Cisco Systems, Inc. assumes no responsibility for errors or omissions that may appear in this publication. We reserve the right to change this publication at any time without notice. This document is not to be construed as conferring by implication, estoppel, or otherwise any license or right under any copyright or patent, whether or not the use of any information in this document employs an invention claimed in any existing **or** later issued patent.

Copyright

© 2001, 2008, 2012 Cisco and/or its affiliates. All rights reserved. Printed in the United States of America.

Information in this publication is subject to change without notice. No part of this publication may be reproduced or transmitted in any form, by photocopy, microfilm, xerography, or any other means, or incorporated into any information retrieval system, electronic or mechanical, for any purpose, without the express permission of Cisco Systems, Inc.

Contents

Safety Precautions	vi
Compliance	viii
Laser Safety	ix
Chapter 1	Introduction
Overview	1-1
Overview of the Prisma II bdr 4:1 Transmit Processor	1-2
The Front Panel of the Processor	1-5
The Front Panel of the bdr Transmitter	1-6
Transmitter Identification	1-8
The Back Panel of the Processor	1-9
Configuration Overview	1-10
Configuration Options.....	1-11
Chapter 2	Installation
Overview	2-1
Before You Begin	2-2
Site Requirements.....	2-3
Preparing for Installation	2-4
Connecting the RF Cables to the Chassis	2-6
Installing the Processor in the Chassis	2-7
Connecting Optical Cables.....	2-9
Installing Transmitters in the Processor.....	2-12
Prisma II Redundancy Interface Panel	2-14
Prisma II Redundancy Interface Panel Features	2-15
Interface Panel Installation and Connections.....	2-16
Master/Slave Connections.....	2-18

Contents, Continued

Chapter 3	Operation Using the ICIM	
	Overview	3-1
	ICIM Introduction	3-2
	The ICIM Front Panel	3-3
	The ICIM Password.....	3-6
	Operating the ICIM	3-12
	Monitoring Operating Status Using the ICIM.....	3-16
	Configuring the Prisma II bdr Transmit Processor Using the ICIM	3-20
	Checking bdr Transmit Processor Alarms Using the ICIM.....	3-24
	Checking Manufacturing Data Using the ICIM.....	3-30
	Using the ICIM to Save the Configuration	3-33
Chapter 4	Operation Using the LCI Software	
	LCI Introduction.....	4-3
	System Requirements.....	4-4
	Obtaining and Installing the Prisma II Driver Update	4-5
	Installing LCI.....	4-6
	Connecting Your Computer to the Chassis	4-10
	Starting LCI	4-11
	LCI Device Tree Overview.....	4-13
	Accessing the Device Details Window	4-15
	Checking the Operating Status.....	4-18
	Configuring the bdr Transmit Processor	4-20
	Checking bdr Transmit Processor Alarms.....	4-22
	Checking Device Properties.....	4-24

Contents, Continued

- Chapter 5 **Maintenance and Troubleshooting**
 - Overview 5-1
 - Module Maintenance 5-2
 - General Troubleshooting Information 5-3
 - Troubleshooting Alarm Conditions..... 5-4
 - Troubleshooting LCI..... 5-6
 - Cleaning Fiber-Optic Connectors..... 5-10

- Chapter 6 **Customer Information..... 6-1**

- Optoelectronic Glossary Glossary -1

- Index Index -1

Safety Precautions

Protect Yourself From Electric Shock and Your System From Damage!

- This product complies with international safety and design standards. Observe all safety procedures that appear throughout this guide, and the safety symbols that are affixed to this product.
- If circumstances impair the safe operation of this product, stop operation and secure this product against further operation.

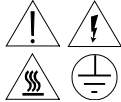

Avoid personal injury and product damage! Do not proceed beyond any symbol until you fully understand the indicated conditions!



You will find this symbol in the literature that accompanies this product. This symbol indicates important operating or maintenance instructions.



You may find this symbol affixed to this product. This symbol indicates a live terminal; the flash points to the terminal device.



You may find this symbol affixed to this product. This symbol indicates a protective earth terminal.



You may find this symbol affixed to this product. This symbol indicates excessive or dangerous heat.

Safety Precautions, Continued

Enclosure

- Do not allow moisture to enter this product.
- Do not open the enclosure of this product unless otherwise specified.
- Do not push objects through openings in the enclosure of this product.

Cables

- Always pull on the plug or the connector to disconnect a cable. Never pull on the cable itself.
- Do not walk on or place stress on cables or plugs.

Factory Service

Refer service only to service personnel who are authorized by the factory.

Compliance

Laser and Electrical Safety

UL 1419:1997: A sample of this equipment has been tested and found to meet the requirements of UL 1419:1997

CSA C22.2 No. 1:1998: A sample of this equipment has been tested and found to meet the requirements of CSA C22.2 No. 1:1998.

21 CFR: A sample of this equipment has been tested and found to meet the requirements of 21 CFR chapter 1, subchapter J.

Electromagnetic Compatibility

FCC Part 15 Subpart B: This equipment has been tested and found to comply with the limits for a Class A digital device according to Part 15 of FCC Rules. These limits are designed to provide reasonable protection against harmful interference when the equipment is operated in a commercial environment.

This equipment generates, uses, and can radiate radio frequency energy and, if not installed and used in accordance with the instruction manual, may cause harmful interference to radio communications. Operation of this equipment in a residential area is likely to cause harmful interference in which case the user will be required to correct the interference at his own expense.

Industry Canada ICES-003: This Class A digital apparatus meets all the requirements of the Canadian Interference-Causing Equipment Regulations.

Industrie Canadienne ICES-003: Cet appareil numérique de la class A respecte toutes les exigences du Règlement sur le matériel brouilleur du Canada.

Laser Safety

Introduction

This product contains an infrared laser that transmits intensity-modulated light and emits invisible radiation.

Warning: Radiation



WARNING:

- **Avoid personal injury! Use of controls, adjustments, or procedures other than those specified herein may result in hazardous radiation exposure.**
 - **Avoid personal injury! The laser light source on this product emits invisible laser radiation. Avoid direct exposure to the laser light source.**
- Do not apply power to this product if the fiber is unmated or unterminated.
 - Do not stare into an unmated fiber or at any mirror-like surface that could reflect light that is emitted from an unterminated fiber.
 - Do not view an activated fiber with optical instruments.

Warning: Fiber Chips



WARNING:

Avoid personal injury! Wear safety glasses and use extreme caution when you handle the glass chips that are inside the cladding of the optical fiber. X-ray cannot detect these glass chips if they become embedded in the skin. Place the chips immediately in a small waste container and discard.

Modifications

Do not make modifications to this product without the approval of Cisco.

Whenever modifications that may affect hazard levels are made to the optical fiber communication system, the person or organization that performs such modification must reassess hazard levels. They must do this by conducting tests and measurements wherever appropriate for the ensurance of compliance. If there is a change in the hazard level, they must re-label this product.

Laser Safety, Continued

Maximum Laser Power

The maximum laser power that can be passed through this product, due to misadjustment or component failure, is 30 mW.

Laser Warning Labels

The Prisma II bdr Transmitter sub-module bears the following labels.



Chapter 1

Introduction

Overview

Introduction

This chapter introduces the front and back panels of the Prisma II™ bdr™ 4:1 Redundant Transmit Processor, the Prisma II bdr Transmitters, and presents a configuration overview.

Qualified Personnel

Only appropriately qualified and trained personnel should attempt to install this product.



WARNING:

Allow only qualified personnel to install, operate, maintain, and service this product. Otherwise, personal injury or equipment damage may occur.

In This Chapter

This chapter contains the following topics.

Topic	See Page
Overview of the Prisma II bdr 4:1 Redundant Transmit Processor	1-2
The Front Panel of the Processor	1-5
The Front Panel of the bdr Transmitter	1-6
Transmitter Identification	1-8
The Back Panel of the Processor	1-9
Configuration Overview	1-10
Configuration Options	1-11

Overview of the Prisma II bdr 4:1 Redundant Transmit Processor

bdr Transmit Processor Overview

The Prisma II optical network is an advanced transmission system designed to optimize network architectures and increase reliability, scalability, and cost effectiveness. The Prisma II bdr 4:1 Redundant Transmit Processor is designed to operate over a range of optical output powers and loss budgets, delivering both analog and digital signals. Microprocessor control allows ease of installation and flexibility of application. The Prisma II bdr 4:1 Redundant Transmit Processor houses up to two bdr transmitters.

For the purpose of this guide, the Prisma II bdr 4:1 Redundant Transmit Processor is often referred to as “the processor”. The Prisma II bdr Transmitters are referred to as the “transmitter”.

bdr Transmit Processor Features

The Prisma II bdr 4:1 Redundant Transmit Processor has the following features.

- Front panel green LED to indicate operating status
- Front panel red LED to indicate alarm status
- -20 dB test point
- Test point selector
- bdr Transmitter insertion slots (2)
- Plug-and-play capability
- Compatible with LCI and TNCS software
- Blind mate RF connections

Overview of the Prisma II bdr 4:1 Redundant Transmit Processor, Continued

Prisma II bdr 4:1 Redundant Transmit Processor Operation

The Prisma II platform supports Baseband Digital Reverse technology. The Prisma II bdr Digital Reverse 4:1 Multiplexing System includes a unique approach for incorporating network redundancy. At the transmit end of the system, typically in a hub or remote terminal, four 7 to 42 MHz (or user selectable 5-40 MHz and 10-45 MHz) analog reverse path signals are input to a transmit processor. The transmit processor converts each signal to a baseband digital data stream and time division multiplexes the four streams into a single data stream. The data stream is duplicated to enable routing for redundant optical transport.

One (non-redundant application) or two (redundant application) transmitters installed within the transmit processor, convert the baseband data stream to an optical signal for transmission at either 1310 nm or 1550 nm ITU grid wavelengths. ITU grid wavelengths are used for Dense Wave Division Multiplexing (DWDM) applications.

On the receive end, typically in a large hub or headend, one or two Prisma II bdr Optical Receivers located in a Prisma II bdr Receive Processor receive the optical signal and perform conversion back to the baseband data stream. The Prisma II bdr Receive Processor demultiplexes the data stream and converts the four resultant data streams back to four broadband analog RF signals.

The Prisma II bdr 4:1 Redundant Transmit Processor can be controlled by an ICIM, the LCI software, or TNCS software. Prisma II bdr 4:1 Redundant Transmit Processor is not compatible with previous Prisma bdr receivers and should only be paired with Prisma II bdr 4:1 Redundant Receive Processors.

Optical Output

Optical output connectors for the Prisma II bdr Transmitters are SC/APC and should only be mated with SC/APC connectorized jumpers or fiber connectors.



WARNING:

Avoid damage to your eyes! Do not look into any optical connector while the system is active. Even if the unit is off, there may still be hazardous optical levels present.

Overview of the Prisma II bdr 4:1 Redundant Transmit Processor, Continued

Prisma II bdr Digital Reverse 4:1 Multiplexing System

A block diagram of the Prisma II bdr Digital Reverse 4:1 Multiplexing System is shown below.

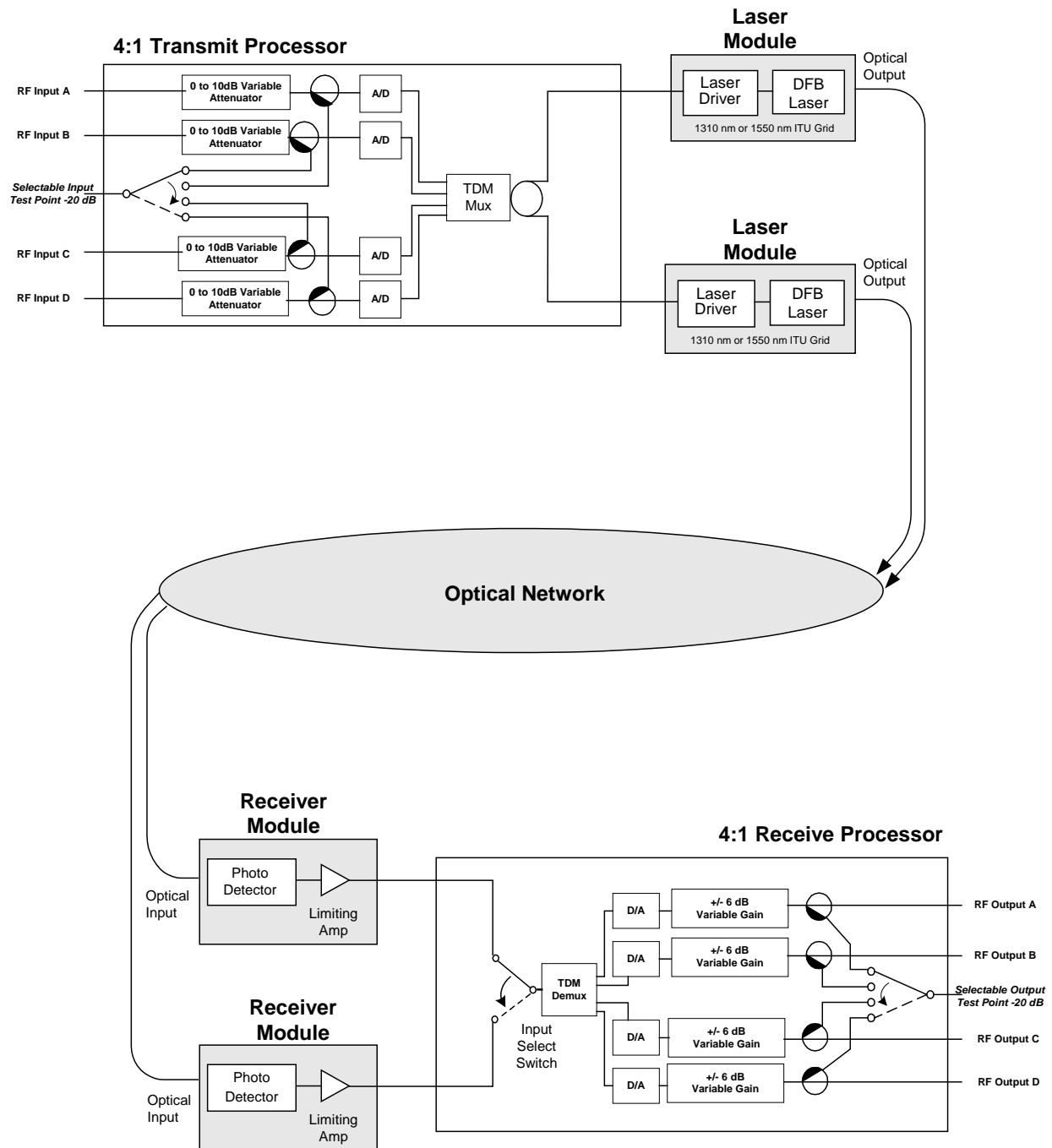

The Front Panel of the Processor

Illustration

The front of the Prisma II bdr 4:1 Redundant Transmit Processor is shown below.

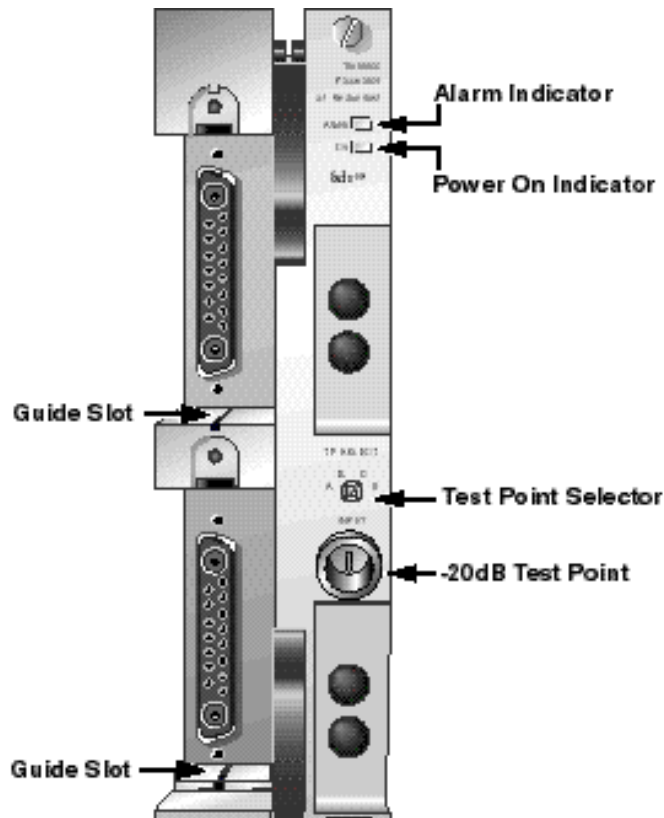

Transmit Processor Front Panel Features

Features of the Prisma II bdr 4:1 Redundant Transmit Processor are shown below.

Feature	Description
Alarm Indicator	Illuminates or blinks when an alarm condition occurs
Power On Indicator	Illuminates when power is supplied to the module
Test point selector	Selects which RF input the -20 dB test point represents
-20 dB Test Point	Provides a -20 dB sample relative to the selected RF input signal
Guide slots	Guide the Prisma II bdr Transmitter into the processor

The Front Panel of the bdr Transmitter

Introduction

The Prisma II bdr 4:1 Redundant Transmit Processor houses one or two Prisma II bdr Transmitter sub-modules. The processor creates a 2.5 Gbps digital representation of the RF reverse path signal and delivers it to the transmitter in PECL format.

The front panel of a Prisma II bdr 4:1 Redundant Transmitter is shown below.

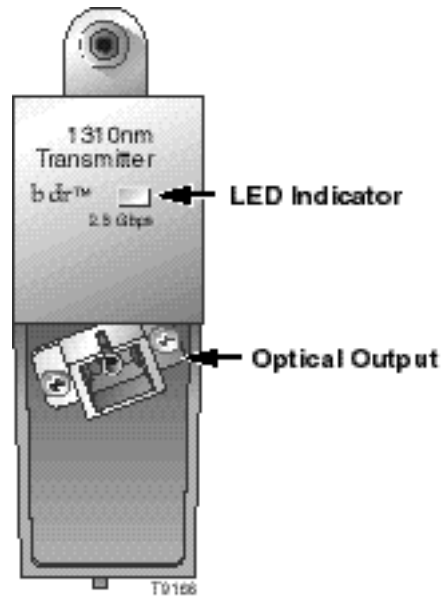

Transmitter Front Panel Features

The features of the front of the Prisma II bdr Transmitter are described below.

Part	Function
LED indicator (bicolor)	Illuminates red when an alarm condition occurs, illuminates green when operation is normal
Optical output	Connects the optical output fiber to the transmit processor

The Front Panel of the bdr Transmitter, Continued

The Bicolor LED

The transmitter incorporates a bicolor LED. The LED is an indicator of laser alarm conditions and DC power presence in the transmitter sub-module.

The bicolor LED status is shown in the table below.

Condition	LED Status/Color
DC Power OFF/optical output OFF	OFF
DC Power ON/alarm condition exists	Red
DC Power ON/No alarm condition	Green
DC Power OFF/optical output ON	N/A

Transmitter Identification

Transmitter Identification Table

The Product ID Number is located on the side of each transmitter sub-module. The following table shows the Product ID Number and how it represents the ITU channel, and wavelength of the Prisma II bdr Transmitter sub-modules.

Product ID	ITU Channel	Wavelength
Prisma II-BDR-LSM-ITU13-00-SA	13	1567.13 nm
Prisma II-BDR-LSM-ITU15-00-SA	15	1565.49 nm
Prisma II-BDR-LSM-ITU17-00-SA	17	1563.86 nm
Prisma II-BDR-LSM-ITU19-00-SA	19	1562.23 nm
Prisma II-BDR-LSM-ITU21-00-SA	21	1560.60 nm
Prisma II-BDR-LSM-ITU22-00-SA	22	1559.79 nm
Prisma II-BDR-LSM-ITU23-00-SA	23	1558.98 nm
Prisma II-BDR-LSM-ITU25-00-SA	25	1557.63 nm
Prisma II-BDR-LSM-ITU27-00-SA	27	1555.74 nm
Prisma II-BDR-LSM-ITU29-00-SA	29	1554.13 nm
Prisma II-BDR-LSM-ITU31-00-SA	31	1552.52 nm
Prisma II-BDR-LSM-ITU33-00-SA	33	1550.91 nm
Prisma II-BDR-LSM-ITU35-00-SA	35	1549.31 nm
Prisma II-BDR-LSM-ITU37-00-SA	37	1547.71 nm
Prisma II-BDR-LSM-ITU39-00-SA	39	1546.11 nm
Prisma II-BDR-LSM-ITU41-00-SA	41	1544.52 nm
Prisma II-BDR-LSM-ITU43-00-SA	43	1542.93 nm
Prisma II-BDR-LSM-ITU45-00-SA	45	1541.34 nm
Prisma II-BDR-LSM-ITU47-00-SA	47	1539.76 nm
Prisma II-BDR-LSM-ITU49-00-SA	49	1538.18 nm
Prisma II-BDR-LSM-ITU51-00-SA	51	1536.60 nm
Prisma II-BDR-LSM-ITU53-00-SA	53	1535.03 nm
Prisma II-BDR-LSM-ITU55-00-SA	55	1533.46 nm
Prisma II-BDR-LSM-ITU57-00-SA	57	1531.89 nm
Prisma II-BDR-LSM-ITU59-00-SA	59	1530.33 nm
Prisma II-BDR-LSM-1310D-00-SA	1310 DFB	~1310 nm *
Prisma II-BDR-LSM-1310F-00-SA	1310 FP	~1310 nm *
Prisma II-BDR-LSM-1550D-00-SA	1550 DFB	~1550 nm *

* Laser wavelength in these products is not precisely controlled.

The Back Panel of the Processor

Back Panel Connectors

Self-mating connectors make it easy to install the Prisma II 4:1 Redundant Transmit Processor in the Prisma II Chassis. The chassis provides:

- RF signal input connection
- Electrical power input connection
- Alarm communications
- Status-monitoring communications
- Communications and control connections



Power and Communications Connector

The power and communications connector on the back of the module mates with a connector inside of the chassis, and supplies power from the chassis to the processor. The 110-pin connector also routes alarm and status-monitoring information from the processor to the Prisma II Chassis.

Configuration Overview

Overview

The Prisma II bdr 4:1 Redundant Transmit Processor is shipped from the factory with operational parameters set to factory defaults. However, you may choose to configure the operating parameters so that they are best suited for your application.

Configuration and Monitoring Methods

The Prisma II bdr 4:1 Redundant Transmit Processor may be controlled using one of three different methods.

- The Prisma II Intelligent Communications Interface Module (ICIM)

If an ICIM is installed in the Prisma II Chassis, it may be used to configure and monitor Prisma II application modules within its domain. For instructions on operating this module using the ICIM, refer to Chapter 3, **Operation Using the ICIM**.

- The Local Craft Interface (LCI) software.

The Local Craft Interface (LCI) software running on a locally connected PC may be used to configure operating parameters of Prisma II modules. For instructions on operating this module using the LCI software, refer to Chapter 4, **Operation Using the LCI Software**.

- Cisco's Transmission Network Control System (TNCS) software.

If the ICIM is installed, TNCS software may be used to configure and monitor all functions of the Prisma II modules. For instructions on operating this module using TNCS, see the manual that was shipped with the TNCS software, *TNCS Administrator Software User's Guide*, part number 730201.

Configuration Summary

Using any of the above methods, you can configure the following parameters.

- Configure the module in master, slave, or independent mode
- Enable or disable redundant mode
- Enable or disable transmitter 1
- Enable or disable transmitter 2
- Set the amount of RF attenuation for all channels

For detailed information on configuring this module, see Chapter 3, **Operation Using the ICIM**, or Chapter 4, **Operation Using the LCI Software**.

Configuration Options

Factory Default Configuration

After initialization, you may restore the processor's factory default configuration at any time. However, you must use an ICIM to be able to use the restore function. The **Restore Factory Defaults** command is the last item in the processor's MFG. DATA menu. For details about the ICIM, the MFG. DATA menu, and the required User password, refer to Chapter 3, **Operation Using the ICIM**.

Other configuration options for the processor are described below.

Internal Redundancy

The Prisma II bdr 4:1 Redundant Transmit Processor may be configured to operate in one of two different redundancy modes.

- **Internal Redundancy (Yes)** - The processor can be configured to operate with internal redundancy where a redundant transmitter is located in the same processor as the primary transmitter. The redundant transmitter is activated only if the primary transmitter has failed. **Redundant Mode (Yes)** is the default setting.
- **Internal Redundancy (No)** - The processor can be configured to operate without redundancy. The primary transmitter operates without backup and does not generate any alarm as long as it is installed and operating.

Laser Function

The processor can be configured to have laser 1 and laser 2 to **Enable** (on) or **Disable** (off). **Enable** is the default setting.

Clock Source Function

The processor can be configured to have its clock source set to Independent (**Independ**), **Master**, or **Slave** mode. **Independ** is the default setting.

Configuration Options, Continued

Attenuation

The amount of attenuation for each of the four RF input channels of the processor can be individually configured. Using the ICIM, the RF input of channels A, B, C, and D can be individually attenuated over a range of 0 dB to 10 dB in 0.5 dB steps. Using the LCI or TNCS software, RF inputs can be individually attenuated over the same range (0 dB to 10 dB), but in 0.1 dB steps. **0 dB** is the default setting.

Alarms

While this module contains no user-configurable alarm thresholds, some alarms may occur as a result of user-configurable settings or user action. For example, muting of all outputs generates an alarm. An alarm is also generated when, in redundant mode, one of the receivers is removed. Another example of user action that could generate an alarm would be disconnection of input cables.

Alarm conditions for specific parameters are labeled as Major, Minor, or as a Fault. Major and Minor alarms also designate if the parameter in alarm is of too high a value (MajorH) or too low a value (MajorL). Major alarms generated by the processor generate a constant, illuminated red LED on the processor front panel. Minor alarms generate a blinking red LED. Alarm conditions may be investigated by using the ICIM, LCI software, or TNCS software.

For specific information on processor alarms see either **Checking bdr Transmit Processor Alarms Using the ICIM**, in Chapter 3, or **Checking bdr Transmit Processor Alarms (LCI)** in Chapter 4.

Configuration Options, Continued

Test Point Selector

The processor front panel houses a -20 dB Test Point (-20 dB relative to the RF input) and a Test Point Selector. The Test Point selector configures which RF output (A, B, C, or D) the -20 dB test point represents. The test point provides a -20 dB sample of the selected RF input signal.

Additional Information

For additional information on configuring the Prisma II bdr 4:1 Redundant Transmit Processor, including factory default settings, see Chapter 3, **Operation Using the ICIM**, or Chapter 4, **Operation Using the LCI Software**.

For specific information on processor alarms see either **Checking bdr Transmit Processor Alarms Using the ICIM**, in Chapter 3, or **Checking bdr Transmit Processor Alarms** in Chapter 4.

Chapter 2 Installation

Overview

Introduction

This chapter contains instructions, site requirements, equipment, and tools needed to install the Prisma II bdr 4:1 Redundant Transmit Processor and Prisma II bdr Transmitters.

Qualified Personnel



WARNING:

Allow only qualified personnel to install, operate, maintain, or service this product. Otherwise, personal injury or equipment damage may occur.

In This Chapter

This chapter contains the following topics.

Topic	See Page
Before You Begin	2-2
Site Requirements	2-3
Preparing for Installation	2-4
Connecting the RF Cables to the Chassis	2-6
Installing the Processor in the Chassis	2-7
Connecting Optical Cables	2-9
Installing Transmitters in the Processor	2-12
Prisma II Redundancy Interface Panel	2-14
Prisma II Redundancy Interface Panel Features	2-15
Interface Panel Installation and Connections	2-16
Master/Slave Connections	2-18

Before You Begin

Overview

Before you begin, make sure that the module is in good condition and that you have the tools and equipment listed here.

Unpacking and Inspecting the Module

As you unpack the module, inspect it for shipping damage. If you find any damage, contact us. Refer to Chapter 6 for information on contacting our Technical Assistance Center.

Equipment and Tools Needed

You need the following equipment and tools to install these modules.

You need . . .	To . . .
a Prisma II Chassis equipped with 56 RF connectors and a Prisma II power supply	provide housing, power and input/output connections to the module.
3/8-in. flat-blade screwdriver	secure the module in the chassis.
two optical cables with SC/APC connectors	carry optical output signals.
four 75 ohm RF cables with F-type connectors	carry RF input signals.
a 7/16-in. open-end wrench	secure RF cables to the connectors on the chassis.

Site Requirements

Overview

Before you begin, make certain that your installation site meets the requirements discussed in this section.

Access Requirements

Ensure that only authorized personnel have access to this equipment. Otherwise, personal injury or equipment damage may occur.



WARNING:

Use this product in locations that restrict access to all persons who are not authorized. Otherwise, personal injury or equipment damage may occur.

Equipment Rack

To install the modules, your site should be equipped with an Electronics Industry Association (EIA) equipment rack that properly houses the Prisma II Chassis with proper spacing for air circulation. For instructions on installing the chassis in the rack, refer to *Prisma II Chassis Installation and Operation Guide*, part number 713375.

Operating Environment



CAUTION:

Avoid damage to this product! Operating this product above the maximum operating temperature specified voids the warranty.

Follow these recommendations to maintain an acceptable operating temperature.

- Temperature inside the rack must be between -40°C and 65°C (-40°F and 149°F).
- Keep cooling vents clear and free of obstructions.
- Provide a non-condensing environment
- Provide ventilation, as needed, using one or more of the following methods.
 - air-deflecting baffles
 - forced-air ventilation
 - air outlets above enclosures

Preparing for Installation

Overview

Before installing the module, review the Prisma II Chassis electrical power, slot availability restrictions, and illustrations discussed in this section.

Electrical Power

The Prisma II modules receive electrical power from the Prisma II Chassis via the Prisma II power supplies. For specific information concerning chassis power requirements and power supply installation, see the guide that was shipped with the chassis, the *Prisma II Chassis Installation and Operation Guide*, part number 713375.

Chassis Slot Availability

The Prisma II bdr 4:1 Transmit Processor is a double-wide module. It may only be installed in slots 5 through 16. Slots 15 and 16 are usually reserved for the Intelligent Communications Interface Module (ICIM), if installed. However, if an ICIM is not installed in slots 15 and 16, this processor or any other module(s) could be installed in those slots.

Power Supply Installation Slot Restrictions (Slots 1 through 4)

Important: Slots 1 through 4 of the Prisma II Chassis are reserved exclusively for the Prisma II primary and redundant power supplies. If a redundant power supply is not installed, and slots 5-16 contain 4:1 Transmit Processors or 4:1 Receive Processors, then no other module can be installed in the redundant power supply slots.

If only one power supply is installed, a Prisma II Power Supply Blank, part number 716308 must be installed in the unused power supply slots.

Front and Rear Access Chassis Styles

The Prisma II Chassis has power inlets, RF input and output ports, and other connectors which are located on the connector interface panel. This panel may be located on the front (front access) or rear (rear access) of the chassis depending on the system you have purchased. Regardless of their location, these connections are labeled the same, serve the same function, and are made in the same manner whether located on the front or the rear of the chassis.

Detailed illustrations of both the front and rear access chassis are located on the next page of this guide.

For more detailed information concerning the connector interface panel, see the guide that was shipped with the chassis, the *Prisma II Chassis Installation and Operation Guide*, part number 713375.

Preparing for Installation, Continued

Rear Access Chassis Illustration

The Prisma II Chassis may be configured with front or rear connectors depending on the system you have purchased. The rear access chassis is shown here.

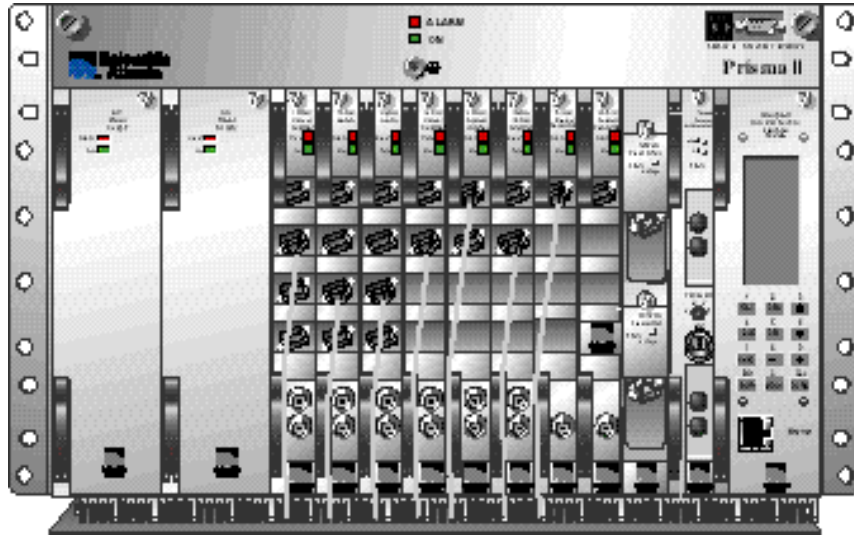

T8026

Front Access Chassis Illustration

The front access chassis is shown here.

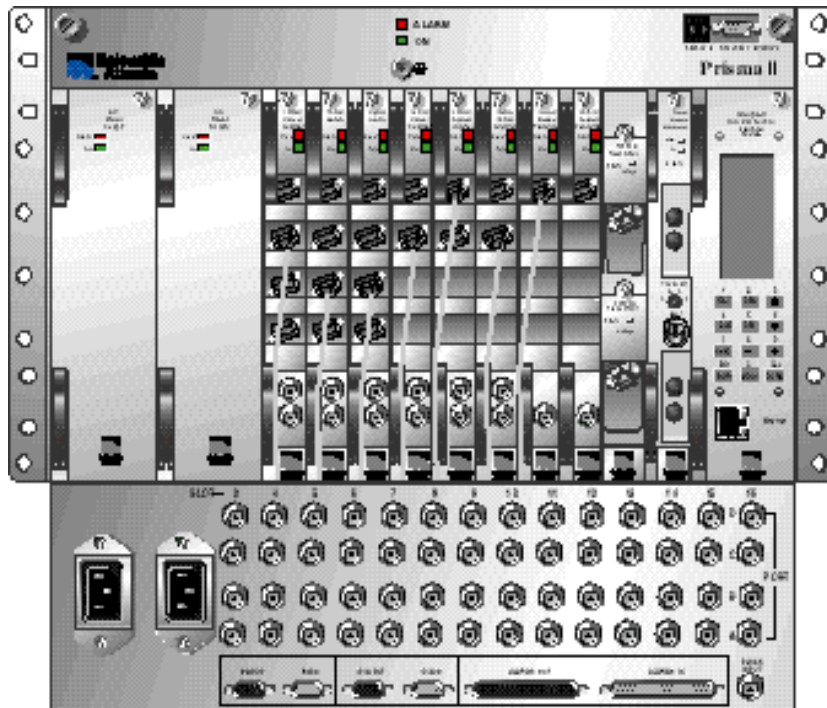

T8025

Connecting the RF Cables to the Chassis

RF Cable Connection Procedure

Follow this procedure to make the RF cable connections for the transmit processor.

1. Locate the RF ports of the corresponding slot where the Prisma II bdr 4:1 Redundant Transmit Processor is to be installed.

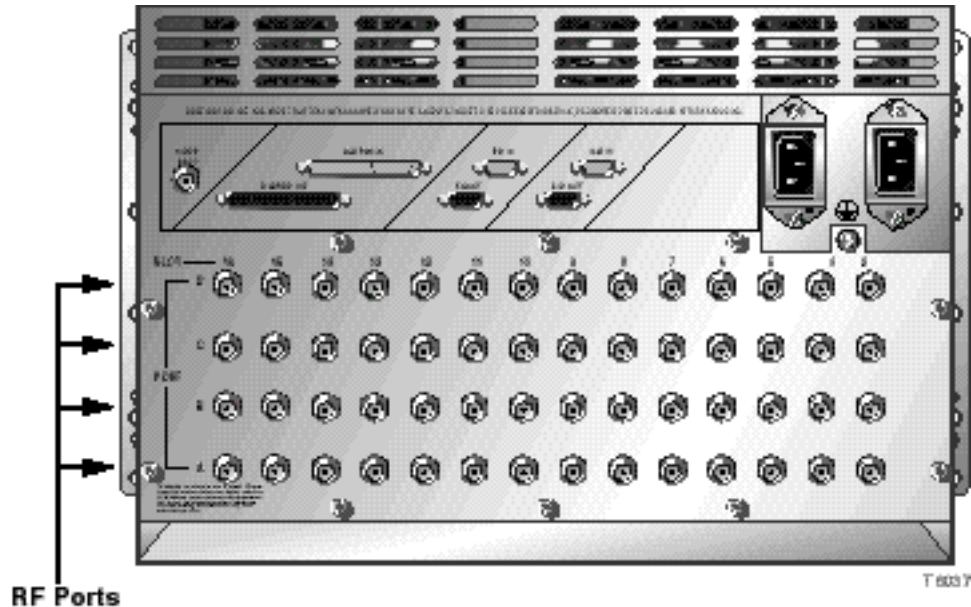

2. Attach one 75 ohm RF cable to Port A connector (RF output 1) of the corresponding slot where the module is to be installed. This is the channel A RF input connection. See the illustration below.
3. Attach the other three 75 ohm RF cables to the Port B, C, and D connectors (RF inputs B, C, and D) of the corresponding slot where the processor is to be installed.

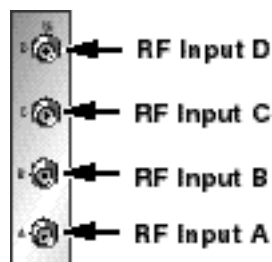

4. Route the four RF cables to the appropriate RF sources.
5. If F-connectors are installed, use a 7/16-in. open-end wrench, secure all cables to the connectors at the chassis.
6. Proceed to the next section, **Installing the Processor in the Chassis.**

Installing the Processor in the Chassis

Installing the Module

Important: The following procedure assumes the Prisma II Chassis is mounted in a rack. This procedure applies to both chassis styles.

To install the transmit processor in the chassis, follow these steps.

1. Locate the fiber guides at the bottom of the chassis and the module guide slots inside the chassis as shown in the following illustration.

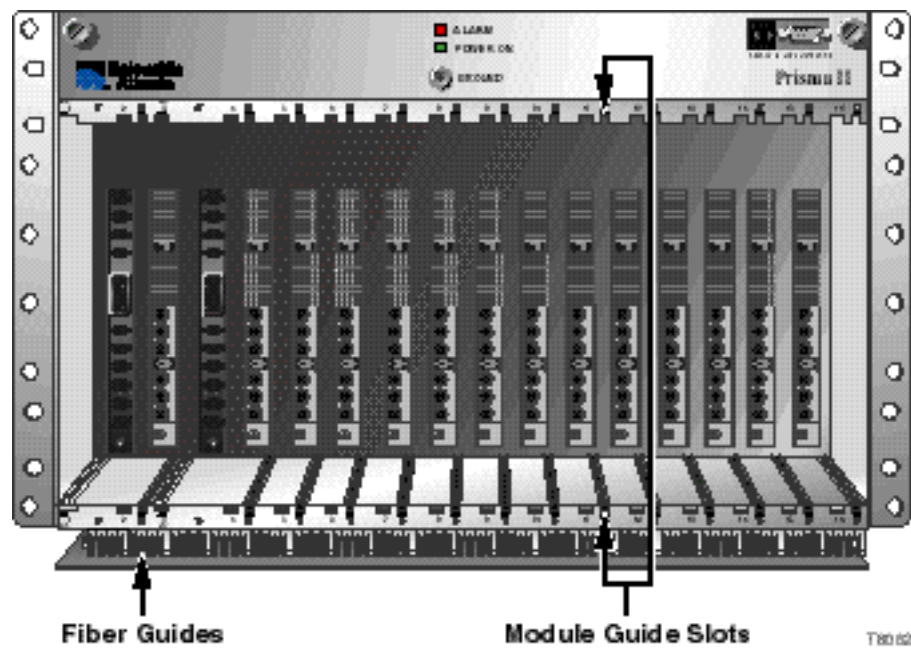

2. Align the ridges on the top and bottom of the processor with the module guide slots located on the chassis. Module ejectors must be fully extended when inserting the processor.

Installing the Processor in the Chassis, Continued

3. Gently slide the processor into the chassis until you feel the power and communications connections on the back of the processor join connectors on the backplane. Use the module ejectors on the left side of the module to lock the module in place.

Note: Do not force or bang the processor into the chassis. If properly aligned, it slides in with minimal force.

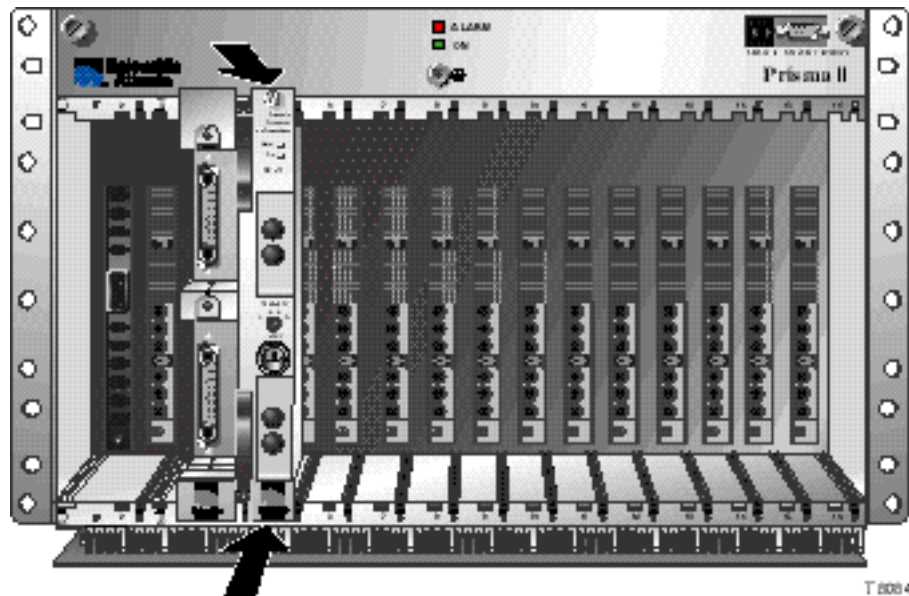

4. Hand-tighten the screw at the top of the processor to secure it in the chassis. Use a $\frac{3}{8}$ -in. flat-blade screwdriver to secure. **Do not over tighten.**

Connecting Optical Cables

The Fiber Fish Tool

The Fiber Fish tool that was shipped along with the Prisma II Chassis is used to pull an optical cable from the rear of the chassis to the front of the chassis so the optical cables can be connected to optical connectors on the front panel of the Prisma II modules.

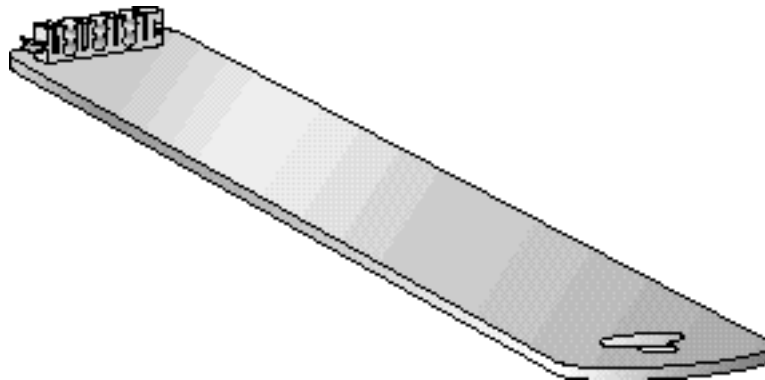

The Fiber Fish Tool Hook

At the end of the Fiber Fish tool is a small hook holds an optical cable so that you can pull it through to the front panel of the Prisma II Chassis.

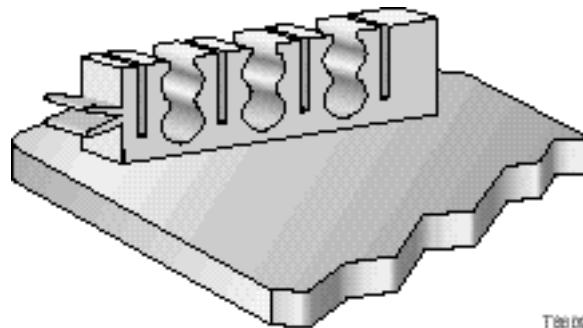

Connecting Optical Cables, Continued

Using the Fiber Fish to Pull the Optical Cable to the Prisma II Module

Important: Use a protective cap to protect the end of the fiber while the fiber is being fished (or handled in general).

To pull the optical cable to the front of the chassis, follow these procedures.

1. Insert the Fiber Fish tool through the slot located just above the bottom of the chassis.
2. At the rear of the chassis, locate the appropriate optical cable.
3. Insert the optical cable into notched area of the Fiber Fish tool as shown.

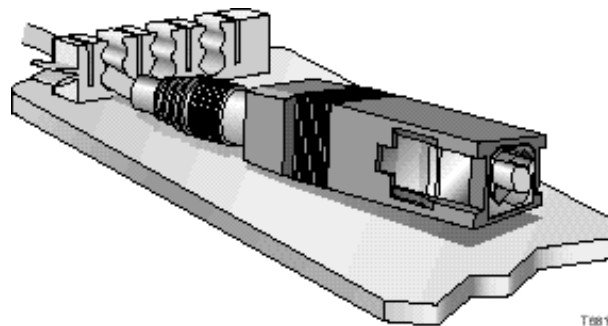

4. At the front of the chassis, pull the Fiber Fish tool (with cable attached) to the front of the chassis.
5. Disengage the optical cable from the Fiber Fish tool and remove the protective cap.
6. Attach the optical cable to the appropriate connector on the processor front panel. See **Cable Connection Procedure**.



WARNING:

Avoid damage to your eyes! Do not look into any optical connector while the system is active. Even if the unit is off, there may still be hazardous optical levels present.

Connecting Optical Cables, Continued

Cable Connection Procedure

Important: This procedure assumes that the Prisma II bdr Transmitter has not been installed in the Prisma II bdr 4:1 Redundant Transmit Processor.

Follow this procedure to make the optical cable connections for each transmitter to be installed.

1. Attach one end of the optical cable to the optical output connector located on the front of the transmitter.

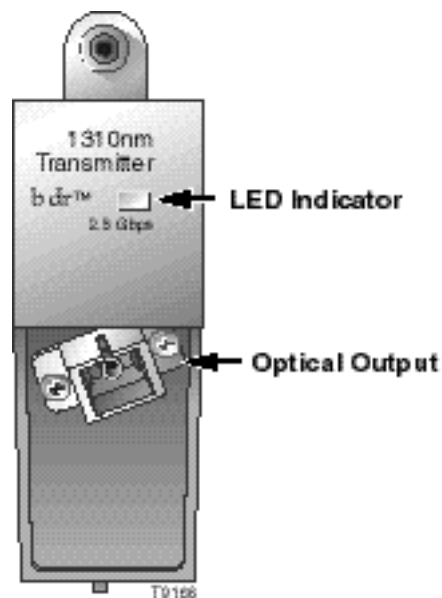

2. Route the other end of the optical cable to the appropriate destination.
3. Repeat steps 1 and 2 for transmitter 2.



WARNING:

Avoid damage to your eyes! Do not look into any optical connector while the system is active. Even if the unit is off, there may still be hazardous optical levels present.

Installing Transmitters in the Processor

Installing the Transmitter

Important! For best results, install the Prisma II bdr 4:1 Redundant Transmit Processor into the Prisma II Chassis before installing the transmitters into the processor. To install the transmitters in the processor, follow these steps.

1. Align the ridges on the top and bottom of the transmitter with the guide slots located on the processor.

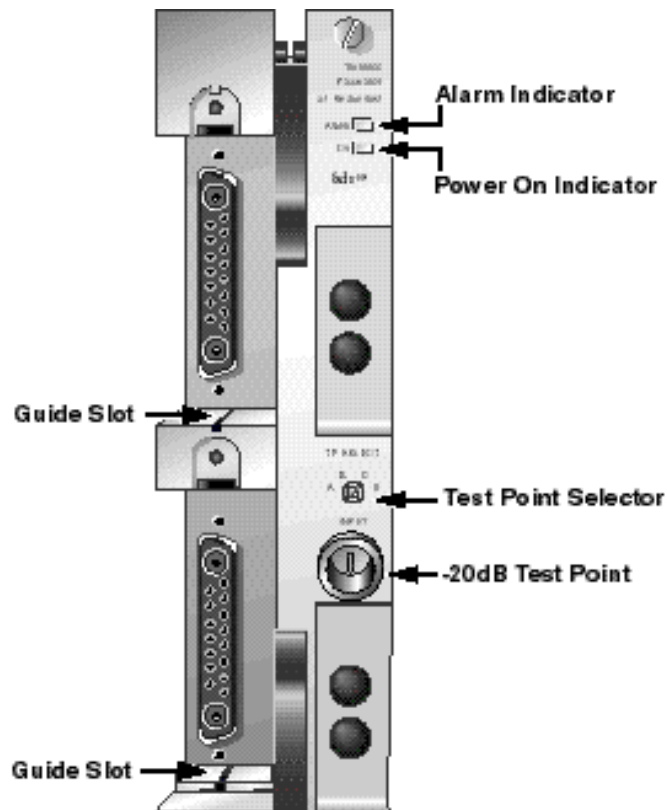

2. Gently slide the transmitter into the processor until you feel the power and communications connections on the back of the transmitter join connectors on the processor. Use the thumbscrew on the top of the transmitter to lock it in place.

Installing Transmitters in the Processor, Continued

Transmitter is Installed

After you have installed both Prisma II bdr Transmitters into the bdr 4:1 Redundant Transmit Processor, the assembly appears as shown below.

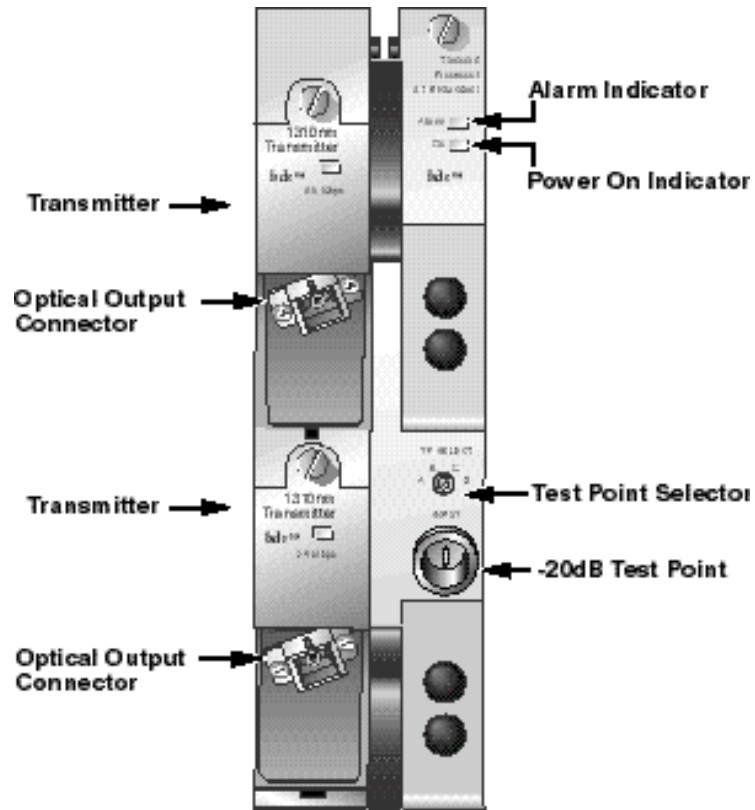

Prisma II Redundancy Interface Panel

Redundancy Interface Panel Introduction

The Prisma II Redundancy Interface Panel is an accessory to the Prisma II platform. The interface panel is intended to be used with the master/slave feature and the contact closure alarm feature of the Prisma II platform.

The terminals on the interface panel serve as extensions to the two DB-37 connectors labeled **ALARMS IN** and **ALARMS OUT** on the connector interface panel of the Prisma II Chassis.

The interface panel consists of the rack-mount panel, two cables, and jumper wire. The panel is to be mounted near the designated Prisma II Chassis in a 19-inch rack.

Slave Mode Operation in Prisma II Modules

All Prisma II modules can be hard-wired to operate as a backup or slave module in a parallel redundant mode.

In this mode, a master and a slave module are interconnected and configured so that if a critical fault occurs in the master, its output is turned off. When this occurs, the slave module senses that the master is no longer operating and is automatically enabled. If the master's critical alarm disappears (for example, by replacing the module), the slave turns off and the master is re-enabled.

Prisma II modules are factory configured in master mode. Modules must be hard-wire connected and manually reconfigured using an ICIM, the LCI software, or Transmission Network Control System (TNCS) in order to operate in slave mode.

Redundancy Interface Panel Illustration (Front)

The front of the Prisma II Redundancy Interface Panel is shown below.



Redundancy Interface Panel Illustration (Rear)

The rear of the Prisma II Redundancy Interface Panel is shown below.

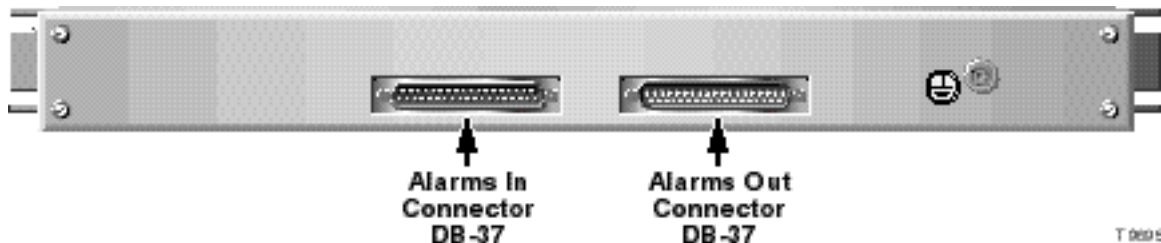

Prisma II Redundancy Interface Panel Features

Prisma II Chassis Slot Numbers

The Prisma II Chassis has sixteen slots. Each chassis slot has two alarm outputs and two alarm inputs. Slot numbers and the corresponding outputs and inputs are represented and labeled just below the terminal strips on the front of the Prisma II Redundancy Interface Panel.

Note: Slot 1 of the Prisma II Chassis is always reserved for the Prisma II Power Supply and has no terminals on the panel. Slot 3 of the Prisma II Chassis is represented on the interface panel, but is reserved for the Prisma II Fan Tray. Therefore, the interface panel's slot 3 spring terminals can only be used as alarm outputs or inputs for the Prisma II Fan Tray.

Terminals Strips

The front of the Prisma II Redundancy Interface Panel has four terminal strips that house spring terminals for each slot. The two left-side strips house two **ALARMS OUT** terminals for each of the chassis slots 2 through 16, and the two right-side strips house two **ALARMS IN** terminals for each of the chassis slots 2 through 16.

Spring Terminals

The spring terminals are the points where the actual hardwire connections between modules are made. Each spring terminal on the interface panel is an extension of a pin on the **ALARMS OUT** and **ALARMS IN** connectors on the Prisma II Chassis. Pressing the bottom lever of the spring terminal allows insertion of a jumper wire into the hole of the terminal. Releasing the lever secures the wire to the terminal.

Alarm Terminal Designations

The **ALARMS OUT** and **ALARMS IN** terminal strips, chassis slot numbers, and A/B spring terminals are labeled just below the terminal strips on the front of the interface panel.

Redundancy Interface Panel Cables

The two supplied DB-37 cables serve as extensions of the **ALARMS IN** and **ALARMS OUT** connectors on the Prisma II Chassis.

Jumper Wire

The 20-gauge insulated jumper wire is used to make hardwire connections between spring terminals. It is to be cut to length, end-stripped, and inserted in the spring terminal.

Wire Routing Clips

Wire routing clips are used to gather loose jumper wires near the interface panel.

Interface Panel Installation and Connections

Redundancy Interface Panel Installation

Follow the steps below to install the Prisma II Redundancy Interface Panel.

1. Position the interface panel in the rack near the designated Prisma II Chassis.
2. Insert a mounting screw through each of the four mounting slots on the front of the interface panel, and then into the rack. (Screws are not included.)
3. Use an appropriate screwdriver to tighten each mounting screw until it is tight.
4. Tie the interface panel to earth ground via the ground stud (ground cable not included).

Important: Grounding the Prisma II Redundancy Interface Panel via the ground stud is especially important for ESD and EMC performance.

Connecting the Redundancy Interface Panel to the Prisma II Chassis

Follow the steps below to connect the Prisma II Redundancy Interface Panel to the Prisma II Chassis.

1. Connect the female end of one DB-37 cable to the male end **ALARMS OUT** connector on the Prisma II Chassis.
2. Connect the male end of the same DB-37 cable to the female end **ALARMS OUT** connector on the rear of the interface panel.
3. Connect the male end of the second DB-37 cable to the female end **ALARMS IN** connector on the Prisma II Chassis.
4. Connect the female end of the second DB-37 cable to the male end **ALARMS IN** connector on the rear of the interface panel.

Connecting a Slave Module to a Master Module Using the Prisma II Redundancy Interface Panel

Follow the steps below to connect a slave module to a master module using the Prisma II Redundancy Interface Panel.

1. On the **ALARMS OUT** strip at the front of the interface panel, locate the slot number representing the chassis slot location of the master module. Connect one end of a jumper wire to spring terminal A of that slot number.
2. Connect the other end of the same jumper wire to the A terminal of the slot of the slave module on the **ALARMS IN** connector. This connection may or may not be on the same interface panel.

Interface Panel Installation and Connections, Continued

3. Repeat steps 1 and 2 for the B terminals of both the master and the slave module's **ALARMS IN** and **ALARMS OUT** terminal strips.
4. Upon connecting all wires, adhere the wire routing clips to the interface panel and connect the wires onto the clips.

Configuring Prisma II Modules as Master or Slave

To configure a module as master or slave, Use the ICIM, LCI, or TNCS software as shown in the guide that was shipped with the specific Prisma II module.

Checking the Master/Slave Connection

Follow the steps below to verify that the master/slave connection is operating properly.

1. Ensure that all master and slave modules are installed, power is applied to your system, and that all cable connections between chassis and the interface panel(s) are secure.
2. Ensure that the primary module is configured to operate as a "master", and the backup module is configured to operate as a "slave" (or as "externally redundant" when connecting bdr processors).
3. Ensure that all jumper wires are securely connected to the proper terminals.
4. When the system is powered and properly configured, remove the master module and verify that the slave module turns on and begins operation. If the slave does not operate, review the installation and connection steps given in this section.

Master/Slave Connections

Redundancy Interface Panel Terminal Strips

On the interface panel terminal strips, all chassis slots except for slot 1 and slot 3 are available. Each chassis slot has two outputs (A and B) and two inputs (A and B) for communication of alarm information to or from other modules. However, on most Prisma II modules, the B output is disabled. See the note below.

Typical Master/Slave Jumper Connections for Modules in the Same Chassis

The diagram below shows the **ALARM OUT** and **ALARM IN** terminal strips and jumper connections for a typical master/slave connection between two modules in the same Prisma II Chassis. The master module is assumed to be in slot 4 and the slave module is in slot 6. If a critical fault occurs in the master module, its relay signal travels from the slot 4 **ALARM OUT** terminal to the slave module slot 6 **ALARM IN** terminal. This turns on the slave module in slot 6. The slave module continues in operation until the master module is fixed. At that time the master module automatically takes over and the slave module switch relay turns off.

Note: The Prisma II Dual Reverse Receiver is the only Prisma II module that requires a second jumper to be connected to the B terminal of the **ALARM OUT** strip for master/slave operation. A single jumper wire from the A terminal of the master to the A terminal of the slave is the only jumper connection required for master/slave operation with all other Prisma II modules. The connection using the B terminals for backing-up a Prisma II Dual Reverse Receiver, is shown as the dotted line.

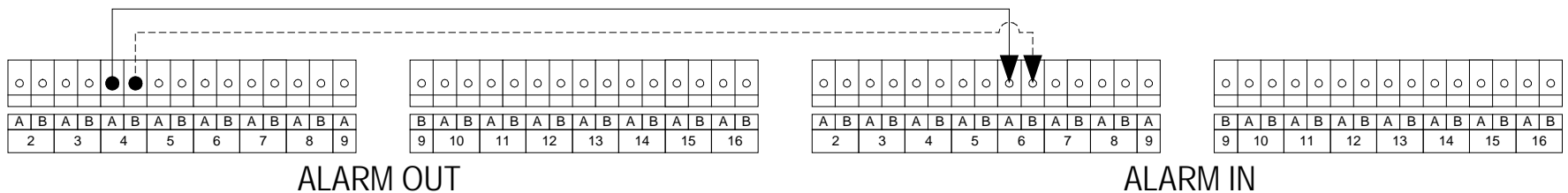

Master/Slave Connections, Continued

Typical Master/Slave Jumper Connections for Modules in Separate Prisma II Chassis

Important! Each Prisma II Chassis that is used for alarm connections must have a separate, dedicated Prisma II Redundancy Interface Panel.

The diagram below shows jumper connections for a typical master/slave connection between two modules in separate Prisma II Chassis. The master module is shown in chassis 1-slot 4 and the slave module is in chassis 2-slot 6. If a critical fault occurs in the master module, its relay signal is carried via the jumpers, from the chassis 1-slot 4 **ALARM OUT** terminal to the chassis 2-slot 6 **ALARM IN** terminal. This turns on the slave module located in chassis 2-slot 6. The slave module continues in operation until the master module is fixed. At that time, the master module automatically takes over and the slave module switch relay turns off.

Note: The Prisma II Dual Reverse Receiver is the only Prisma II module that requires a second jumper to be connected to the B terminal of the **ALARM OUT** strip for master/slave operation. A single jumper wire from the A terminal of the master to the A terminal of the slave is the only jumper connection required for master/slave operation with all other Prisma II modules. The connection using the B terminals for backing-up a Prisma II Dual Reverse Receiver, is shown as the dotted line.

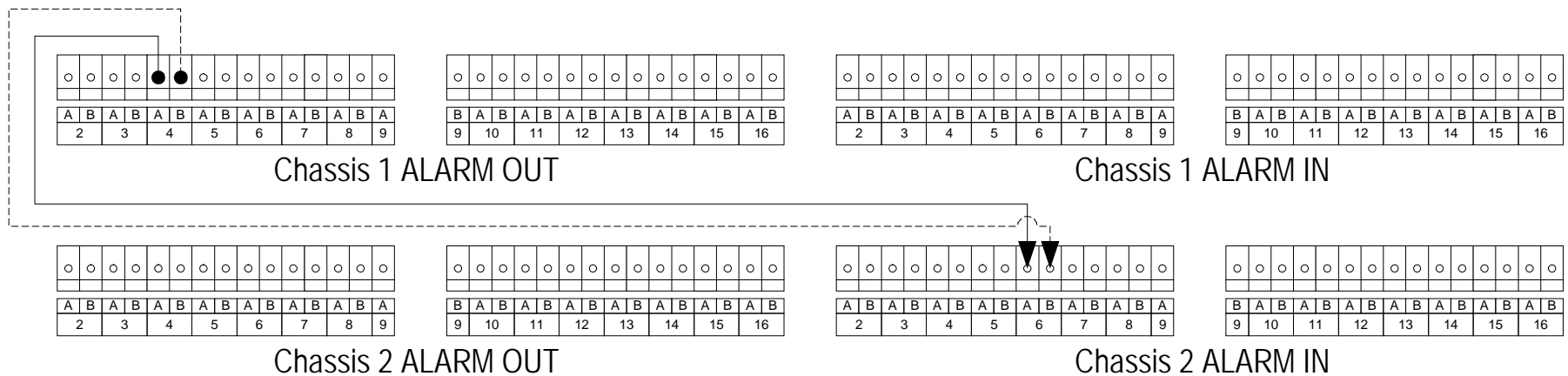

Chapter 3

Operation Using the ICIM

Overview

Introduction

The procedures in this chapter apply if you are using the Prisma II Intelligent Communications Interface Module (ICIM) to configure and operate the Prisma II bdr 4:1 Redundant Transmit Processor.

Scope of This Chapter

Included in this chapter are descriptions of the ICIM front panel and the ICIM LCD, and detailed procedures on how to use the software menus to configure the transmitter.

In This Chapter

This chapter contains the following topics.

Topic	See Page
ICIM Introduction	3-2
The ICIM Front Panel	3-3
The ICIM Password	3-6
Operating the ICIM	3-12
Monitoring Operating Status Using the ICIM	3-16
Configuring the Prisma II bdr Transmit Processor Using the ICIM	3-20
Checking bdr Transmit Processor Alarms Using the ICIM	3-24
Checking Manufacturing Data Using the ICIM	3-30
Using the ICIM to Save the Configuration	3-33



WARNING:

Avoid damage to your eyes! Do not look into any optical connector while the system is active. Even if the unit is off, there may still be hazardous optical levels present.

ICIM Introduction

ICIM Function

The ICIM functions as the user interface to the Prisma II application modules as well as the interface between the Prisma II modules and the Transmission Networks Control Systems (TNCS) software. The ICIM allows local module configuration and status monitoring for up to 82 modules located in multiple chassis. The ICIM features easy-to-use software that is navigated using the numeric keypad and the LCD display.

Important: Do not operate any Prisma II Chassis without a fan tray installed properly. If a fan tray is not installed in the Prisma II Chassis, the ICIM will not communicate with any of the modules in that chassis.

Important: All chassis connected in a “daisy-chain” must be powered and have a fan tray installed. A chassis that is connected but is either not powered, or does not have a fan tray installed, will cause faulty operation of the ICIM.

Important: All chassis connected in this “daisy-chain” must have a unique chassis I.D. number.

ICIM Block Diagram

The ICIM is illustrated in the block diagram below.

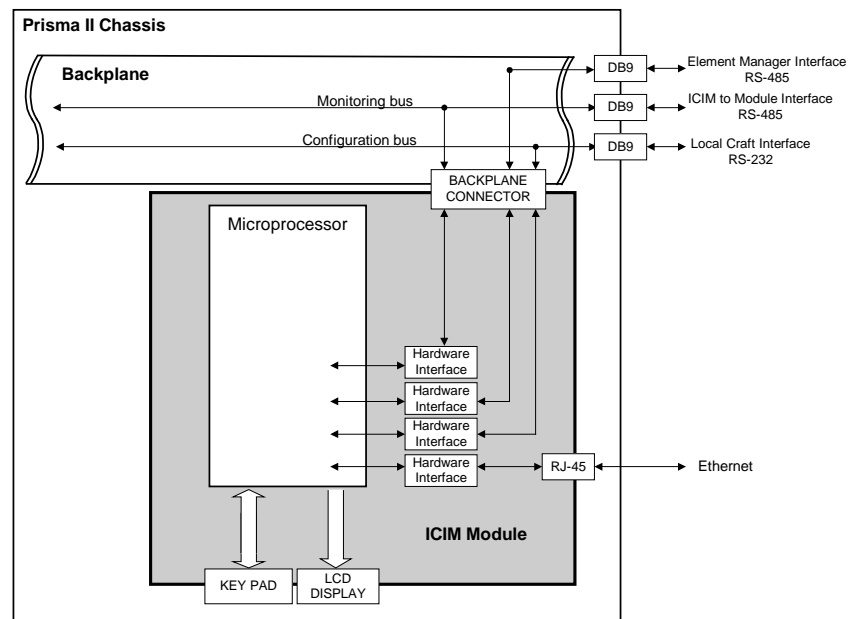

The ICIM Front Panel

ICIM Front Panel Illustration

The illustration below shows the front panel of the ICIM.

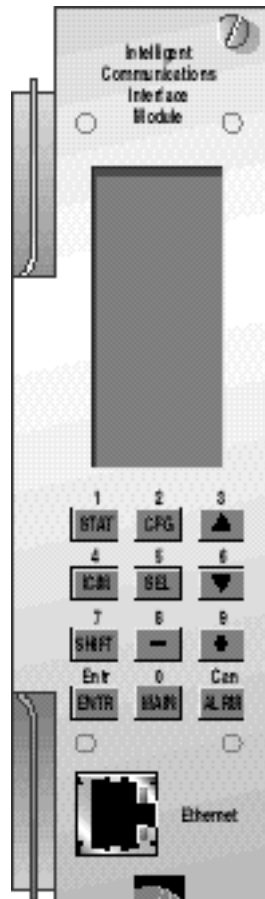

The ICIM Front Panel, Continued

ICIM Front Panel Features

Part	Function
LCD screen	Displays the ICIM menus, alarms, and status information.
12-key numeric keypad	Used to navigate the ICIM's menus and configure the application modules.
Ethernet connector	Directly connects the ICIM to a network (future release).

The ICIM LCD

The ICIM LCD is the operator's visual link to the ICIM software. When the ICIM is installed and powered up, the **MAIN** menu is displayed on the LCD. The following illustration shows the ICIM's **MAIN** menu.

MAIN

Offline

Modules
15

Alarms
0













Scroll

Module
Shelf
Slot

The ICIM Front Panel, Continued

The ICIM Key Pad

The ICIM keypad has twelve keys for entering and monitoring operational parameters. The table below lists each key and a brief description of its function.

Button	Function
	Displays status information for the selected module
	Displays configuration information for the selected module
	Displays all of the parameters in alarm for a selected module
	Moves the menu selection area up
	Moves the menu selection area down
	Selects the highlighted parameter
	Displays ICIM module information such as firmware version, serial number, and baud rate
	Shifts function of a keypad button to the function or number label just above that button
	Decreases numerical readings of selected configuration parameters
	Increases numerical readings of selected configuration parameters
	Enters input data (if valid)
	Exits the current menu and displays the MAIN menu

The ICIM Password

Using the ICIM Password

The ICIM allows you to send configuration commands, to check alarms and operating status, and restore factory default settings in Prisma II modules. In order to ensure that no unauthorized changing of these parameters occurs, you have the option of using a password protection system. Password authorization only applies to the configurable parameters. Status and alarm information is always available on the ICIM regardless of password implementation.

The password system consists of:

- The User password - **User Psw**. A user-settable password. The User password is created, entered, and changed by the system operator(s). The password must be exactly eight digits using only the 0-9 number keys.
- The ability to change an existing User password - **Change Psw**.
- The ability to disable the User password function - **Disable Psw**.
- A service password - **SA Psw**. Used only by Cisco personnel.

Important: If you only want to monitor status and alarm data, simply skip the password function when it appears on the ICIM menu. You can access all module status and alarm information without a password. However, once a user password is entered, you are required to enter it every time you want to set configurable parameters to any module controlled by that ICIM. See **Expired Password or Inactive Password Messages** and **Entering the User Password** that follow.

The ICIM Password, Continued

Accessing the Password Function

The Password menu allows you to create, enter, change, or disable the user password. It also allows service personnel to use the Cisco (SA) password. To access the Password menu, follow the steps below.

1. Press the **ICIM** key.
2. Use the **▼** key to scroll down until **Password** is highlighted.
3. Press the **SEL** key. The Password menu is displayed. **User Psw** is highlighted.

MAI N	ICIM	ICIM	ICIM
-----	-----	-----	-----
Off line	Shelf 0	Shelf 0	Shelf 0
-----	Slot 15	Slot 15	Slot 15
-----	-----	-----	-----
Modules	Mfg Data	Mfg Data	User Psw
0	-----	-----	-----
Alarms	-----	-----	SA Psw
0	-----	-----	-----
-----	Password	Password	-----
-----	-----	-----	Change Psw
Scroll	-----	-----	-----
-----	-----	-----	-----
Module	Update Adr	Update Adr	Disable
Shelf	-----	-----	Psw
Slot	-----	-----	-----







Expired Password or Inactive Password Messages

The entry of a valid User or SA password allows changes to system parameters for a period of 10 minutes. If more than 10 minutes has passed since your last keystroke, and you attempt to make any changes to system parameters, the menu displays **Psw Expired**. If, after more than 10 minutes, you attempt to disable the password the menu displays **Failed, Password Not Active**. If either of these messages is displayed, you are required to re-enter the password. To re-enter the password, follow the procedure in the section **Entering or Enabling the User Password**.

The ICIM Password, Continued

Using Your Password for the First Time

Important: To enter a User password in an ICIM that has never had the User password function implemented, follow the steps in the procedure below.

1. Access the password function as shown in **Accessing the ICIM Password Function**.
2. Use the  key to scroll down until **Change Psw** is highlighted.
3. Press the  key. **Change Psw/Shift Off** is displayed.
4. Press the  key to display **Shift On** - then enter 8 digits as your User password, using the 0-9 number keys. If at any time you input a digit that is incorrect or you wish to change a digit, use the **CAN** (Cancel) function by pressing the  key to delete that digit.
5. Press the  key. The ICIM updates the display to show if your password entry was accepted or rejected. If the entry was accepted, you are able to return to the MAIN menu.
6. If the password you entered is rejected, press the  key to return to the password function, then re-enter an 8-digit password using only the 0-9 number keys. Press the  key.

Reasons for a User password to be rejected include:

- Entering more than 8 digits for the password
- Pressing keys other than the 0-9 number keys
- Entering an incorrect password if a valid password has been entered

The ICIM Password, Continued

Re-Entering a User Password

If more than 10 minutes have passed since your last keystroke, and you attempt to make any changes to system parameters, the menu displays **Psw Expired**. If you attempt to disable the password, the menu displays **Failed, Password Not Active**. When either of these messages is displayed, you must re-enter the User password as outlined in the steps below.

1. Access the password as described in **Accessing the Password Function**.
2. Press the **SEL** key. **User Psw/Shift Off** is displayed.
3. Press the **SHIFT** key to display **Shift On** - then enter the 8 digits of the User password, using the 0-9 number keys. If at any time you input a digit that is incorrect or you wish to change a digit, use the **CAN** (Cancel) function by pressing the **ALRM** key to delete that digit.
4. Press the **ENTER** key. The ICIM updates the display to show if your password entry was accepted or rejected. If the entry was accepted, you are able to return to the MAIN menu.
5. If the password you entered is rejected, press the **SHIFT** key to return to the password function, then re-enter your password. Press the **ENTER** key.

Reasons for a User password to be rejected include:

- Entering more than 8 digits for the password
- Pressing keys other than the 0-9 number keys
- Entering an incorrect password if a valid password has been entered







ICIM	ICIM	ICIM	ICIM
Shelf 0 Slot 15	Shelf 0 Slot 15	Shelf 0 Slot 15	Shelf 0 Slot 15
User Psw	User Psw *****	User Psw 1234****	User Psw 12345678
Shift Off	Shift On	Rejected Shift Off	Accepted Shift Off

The ICIM Password, Continued

Changing the User Password

Important: The current User password must be active prior to changing it. If the current password has expired (more than 10 minutes have passed since your last keystroke), you must re-enter the current password before changing to a new one.

Follow the steps below to change the User password.

1. Access the password function as shown in the procedure **Accessing the Password Function**.
2. Use the  key to scroll down until **Change Psw** is highlighted.
3. Press the  key to select **Change Psw**.
4. When **Change Psw /Shift Off** is displayed, press the  key to display **Shift On** - then enter the 8 digits of your new password, using the 0-9 number keys. If you input a digit that is incorrect or wish to change a digit, use the **CAN** (Cancel) function by pressing the  key to delete that digit.
5. Press the  key to. The ICIM updates the display to show if your password entry was accepted or rejected. If the entry was accepted, you are able to return to the MAIN menu.
6. If the new password you entered is rejected, press the  key to return to the password function, then re-enter the new 8-digit password. Press the  key.

<pre>ICIM ----- Shelf 0 Slot 15 ----- User Psw ----- SA Psw ----- Change Psw ----- Disable Psw</pre>	<pre>ICIM ----- Shelf 0 Slot 15 ----- Change Psw ----- Shift Off</pre>	<pre>ICIM ----- Shelf 0 Slot 15 ----- Change Psw ***** ----- Shift On</pre>	<pre>ICIM ----- Shelf 0 Slot 15 ----- Change Psw 87654321 ----- Shift On</pre>
---	---	--	---

The ICIM Password, Continued

Disabling the User Password

If a User password has been entered, you may disable it at any time. However, the current password must be active prior to disabling it. If the current password has expired (more than 10 minutes have passed since your last keystroke), you must re-enter the current password before disabling it.

1. Press the **ICIM** key.
2. Use the **▼** key to scroll down until **Password** is highlighted.
3. Press the **SEL** key.
4. Use the **▼** key to scroll down until **Disable Psw** is highlighted.
5. Press the **SEL** key to select **Disable Psw**.
6. If the current password is active, the menu displays **Password Is Now Disabled**. You can now make changes to parameters without any password.
7. If the current password has expired (more than 10 minutes have passed since your last keystroke), the menu displays **Failed, Password Not Active**. You must re-enter the current password and then repeat this procedure.

ICIM	ICIM	ICIM
----- Shelf 0 Slot 15 ----- User Psw ----- SA Psw ----- Change Psw ----- Disable Psw -----	----- Shelf 0 Slot 15 ----- ----- ----- Password Is Now Disabled ----- Shift Off	----- Shelf 0 Slot 15 ----- ----- ----- Failed, Password Not Active ----- Shift Off

Operating the ICIM

Using the ICIM

Once the module is installed as described in Chapter 2, it runs without the aid of an operator. Unless alarms are generated or your system configuration changes, you should not need to make any adjustments to the module beyond the initial setup.

Accessing the ICIM LCD Contrast

To access the ICIM LCD contrast control from the MAIN menu, press the **ICIM** key. Use the **+** key to increase or the **-** key to decrease ICIM display contrast.

The MAIN Menu

A few seconds after power-up, the MAIN menu (shown below) is displayed. Press the **SEL** key to select the specific option.

Display	Description
Offline	Indicates TNCS communication status with the ICIM
Modules	Indicates the number of modules in the ICIM domain.
Alarms	Displays the number of modules that are in alarm. Selecting this option allows scrolling through all modules in alarm condition.
Scroll	Allows scrolling through all modules in the ICIM domain.
Module Shelf Slot	Allows selection of any specific module in the ICIM domain.

MAIN

Offline

Modules
15

Alarms
0

Scroll

Module
Shelf
Slot

Operating the ICIM, Continued

Prisma II ICIM Menu

To display the ICIM menu, press the **ICIM** key. The ICIM menu (shown below) is displayed. Press the **SEL** key to select the specific option.

Display	Description
Shelf Slot	Displays the location of the ICIM module. Shelf = Chassis ID number on the front of the chassis. Slot = Slot number in the chassis.
Mfg Data	Displays manufacturing data about the ICIM.
Password	Allows you to enter, change, or disable a system password. See The ICIM Password earlier in this chapter.
Update Adr	If the Chassis ID number switch has been changed, you must highlighted the Update Adr menu and press the SEL key for the ICIM to recognize the change.

ICIM	
Shelf	0
Slot	15

Mfg Data	

Password	

Update Adr	

ICIM	
Shelf	0
Slot	15

Mfg Data	

Password	

Update Adr	

ICIM	
Shelf	0
Slot	15

Mfg Data	

Password	

Update Adr	

Operating the ICIM, Continued

Prisma II MAIN Menu Structure

Pressing the **MAIN** key initiates the MAIN software menu. Pressing the **ICIM** key initiates the ICIM software menu. The MAIN and ICIM software structures are shown below.

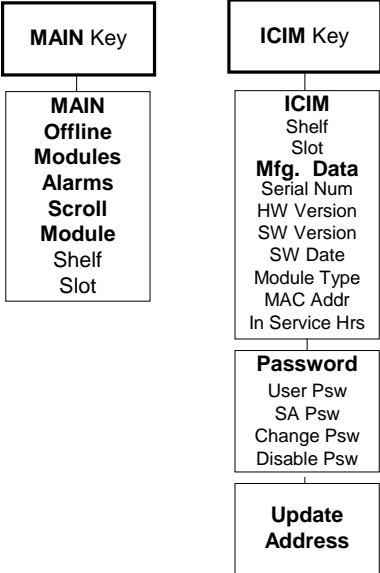

Operating the ICIM, Continued

Prisma II bdr Transmit Processor Software Menu Structure

From the MAIN or SCROLL menus, you can navigate to the Prisma II bdr Transmit Processor MODULE menu. From the MODULE menu, press the **STAT**, **CFG**, or **ALRM** key to display the desired parameter menu.

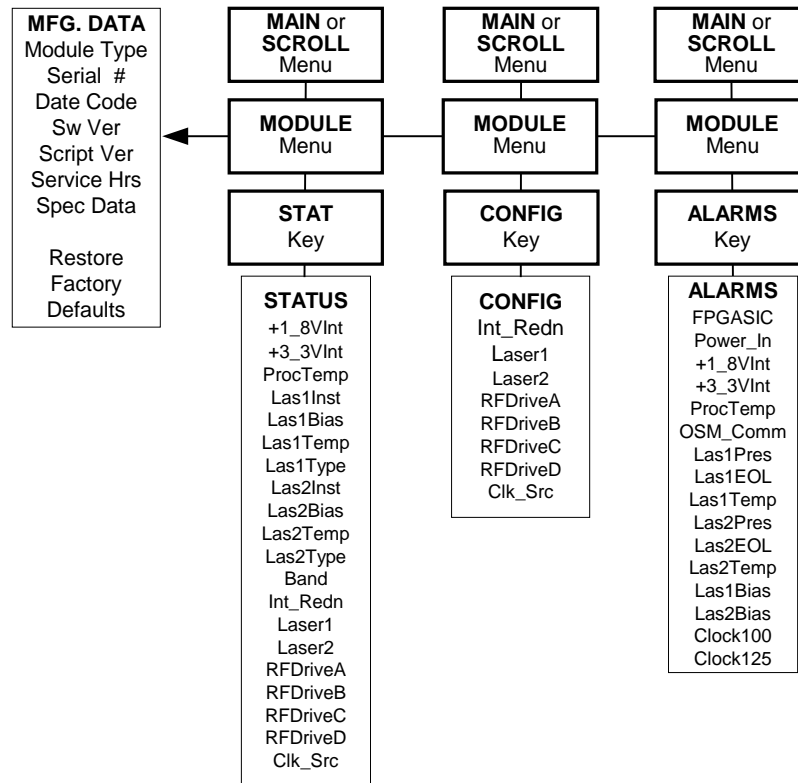

Monitoring Operating Status Using the ICIM

Monitored Parameters

You can monitor the status of operating parameters. The table below describes the monitored parameters for this module.

Parameter	Units	Function
+1_8VInt	V	Internal voltage level-nominal 1.8 V DC.
+3_3VInt	V	Internal voltage level-nominal 3.3 V DC.
ProcTemp	°C	Indicates processor temperature.
Las1Inst	Yes or No	Indicates if transmitter is installed.
Las1Bias	mA	Indicates laser 1 bias current.
Las1Temp	delC	Indicates laser 1 temperature in degrees C relative to its target temperature.
Las1Type	0 or 3	Indicates what type of transmitter is installed. 0 = 1550 nm cooled laser 3 = Uncooled 1550 nm or 1310 nm laser
Las2Inst	Yes or No	Indicates if transmitter is installed.
Las2Bias	mA	Indicates laser 1 bias current.
Las2Temp	delC	Indicates laser 2 temperature in degrees C relative to its target temperature.
Las2Type	0 or 3	Indicates what type of transmitter is installed. 0 = 1550 nm cooled laser 3 = Uncooled 1550 nm or 1310 nm laser
Band	MHz	Indicates how the frequency bandwidth of the processor has been set in the CONFIG menu.
Int_Redn	Yes or No	Indicates how the redundancy mode for a second transmitter in the same processor has been set in the CONFIG menu. If Yes , the transmitter acts as a backup to the primary transmitter. If No , redundancy is off.













Monitoring Operating Status Using the ICIM, Continued

Parameter	Units	Function
Laser1	Enable or Disable	Indicates how laser 1 has been set in the CONFIG menu.
Laser2	Enable or Disable	Indicates how laser 2 has been set in the CONFIG menu.
RFDriveA RFDriveB RFDriveC RFDriveD	dB	Indicates how the RF drive level at the RF inputs are actually set in the CONFIG menu.
Clk_Src	Indpend, Master, or Slave	<p>Indicates how the clock signal has been set in the CONFIG menu.</p> <p>Indpend - The transmitter generates the clock signal but does not send it outside the module.</p> <p>Master - The transmitter generates its own clock signal and sends it out.</p> <p>Slave - Uses the clock input supplied from the backplane, typically from another transmitter in Master mode. If the clock is not present clock alarms are generated.</p>

Monitoring Operating Status Using the ICIM, Continued

Checking Operating Status

Using the ICIM, you can check the status of all operating parameters of this module. To monitor the module operating parameters, follow these steps.

1. From the MAIN menu, press the  key to highlight **Shelf** and **Slot** fields.
2. Press the  key to address the **Shelf** number. Then press the  key or the  key to scroll to the number of the desired shelf.
3. Press the  key. The **Slot** field is highlighted.
4. Press the  key or the  key to scroll to the number of the desired slot.
5. Press the  key. The information for the module of interest is now displayed on the ICIM menu.
6. Press the  key.
7. Press the  key or the  key to scroll through the monitored parameters until you find the parameter of interest.
8. Check the status of the desired parameter or select other parameters to monitor. When finished, press the  key to return to the MAIN menu.

STATUS Menus

Press  to select the **STATUS** menus. Typical **STATUS** menus are shown below.

STATUS	STATUS	STATUS	STATUS
----- Shelf 0 Slot 14 -----	----- Shelf 0 Slot 14 -----	----- Shelf 0 Slot 14 -----	----- Shelf 0 Slot 14 -----
bdr 4:1R TRANSMIT PROCESSOR -----	bdr 4:1R TRANSMIT PROCESSOR -----	bdr 4:1R TRANSMIT PROCESSOR -----	bdr 4:1R TRANSMIT PROCESSOR -----
Band 5- 40MHz +1_8 VInt 1.809 V ▲ ▼	+3_3 VInt 3.301 V ProcTemp 30.50 C ▲ ▼	Las1Inst Yes Las1Bias 29.08 mA ▲ ▼	Las1Temp 0 delC Las1Type 0 Type ▲ ▼

Monitoring Operating Status Using the ICIM, Continued

```

STATUS
-----
Shelf    0
Slot     14
-----
bdr 4:1R
TRANSMIT
PROCESSOR
-----
Las2Inst
  Yes
-----
Las2Bias
29.08 mA
  ▲ ▼
    
```

```

STATUS
-----
Shelf    0
Slot     14
-----
bdr 4:1R
TRANSMIT
PROCESSOR
-----
Las2Temp
0      de lC
-----
Las2Type
  3
  ▲ ▼
    
```

```

STATUS
-----
Shelf    0
Slot     14
-----
bdr 4:1R
TRANSMIT
PROCESSOR
-----
Int_Redn
  Yes
-----
Laser1
Enable
  ▲ ▼
    
```

```

STATUS
-----
Shelf    0
Slot     14
-----
bdr 4:1R
TRANSMIT
PROCESSOR
-----
Laser2
Enable
-----
RFDriveA
0      dB
    
```

```

STATUS
-----
Shelf    0
Slot     14
-----
bdr 4:1R
TRANSMIT
PROCESSOR
-----
RFDriveB
0      dB
-----
RFDriveC
0      dB
  ▲ ▼
    
```

```

STATUS
-----
Shelf    0
Slot     14
-----
bdr 4:1R
TRANSMIT
PROCESSOR
-----
RFDriveD
0      dB
-----
Clk_Src
Indpend
  ▲ ▼
    
```

Configuring the Prisma II bdr Transmit Processor Using the ICIM

Configurable Parameters















Configurable parameters for this module include the following.

Parameter	Function	Values	Default
Int_Redn	Internal Redundancy. When set to Yes , the module will generate an alarm if either transmitter is removed.	Yes or No	Yes
Laser1	Controls whether laser 1 is enabled or disabled. If Disable , laser 1 will be forced off. If Enable , this control will allow the laser to operate but will be subject to transmitter safeguards that prevent the laser from operating (e.g., when the wavelength would be out of specification).	Enable or Disable	Enable
Laser2	Controls whether laser 2 is enabled or disabled. If Disable , laser 2 will be forced off. If Enable , this control will allow the laser to operate but will be subject to transmitter safeguards that prevent the laser from operating (e.g., when the wavelength would be out of specification).	Enable or Disable	Enable
RFDriveA RFDriveB RFDriveC RFDriveD	Sets the amount of RF attenuation for channel A, B, C, and D.	0 to 10 dB in .5 dB steps	0 dB
Clk_Src	<p>Indpend = The transmitter generates the clock signal but does not send it outside the module.</p> <p>Master mode = The transmitter generates its own clock signal and sends it out.</p> <p>Slave mode = Uses the clock input supplied from the backplane, typically from another transmitter in Master mode. If the clock is not present clock alarms are generated.</p>	Indpend, Master, or Slave	Indpend

Configuring the Prisma II bdr Transmit Processor Using the ICIM, Continued

Configuring Parameters

Using the ICIM, you can configure the parameters listed above. To configure the parameters, follow these steps. CONFIG parameters are listed after these procedures.

1. From the MAIN menu, press the  key to highlight the **Shelf** and **Slot** fields.
2. Press the  key to address the **Shelf** number. Then press the  key or the  key to scroll to the number of the desired shelf.
3. Press the  key. The **Slot** field is highlighted.
4. Press the  key or the  keys to scroll to the number of the desired slot.
5. Press the  key. The initial information for the module of interest is now displayed on the ICIM menu.
6. To configure the module, press the  key.
7. Press the  key or the  key to scroll through the configurable controls until you find the parameter of interest.
8. Press the  key to select the highlighted control.
9. Press the  key or the  key to activate or change the value of the selected control.
10. Press the  key to save the changes and return to the MAIN menu.

Configuring the bdr Transmit Processor Using the ICIM, Continued

CONFIG Menus

Some typical Prisma II bdr Transmit Processor CONFIG menus are shown below.

<pre> CONF I G ----- Shelf 0 Slot 14 ----- bdr 4:1R TRANSMIT PROCESSOR ----- Band Int_Redn Laser1 Laser2 RFDriveA ▲ ▼ </pre>	<pre> CONF I G ----- Shelf 0 Slot 14 ----- bdr 4:1R TRANSMIT PROCESSOR ----- RFDriveB RFDriveC RFDriveD Clk_Src </pre>	<pre> CONF I G ----- Shelf 0 Slot 14 ----- bdr 4:1R TRANSMIT PROCESSOR ----- Int_Redn YES ▲ ▼ </pre>	<pre> CONF I G ----- Shelf 0 Slot 14 ----- bdr 4:1R TRANSMIT PROCESSOR ----- Laser1 Enable ▲ ▼ </pre>
<pre> CONF I G ----- Shelf 0 Slot 14 ----- bdr 4:1R TRANSMIT PROCESSOR ----- Laser2 Enable ▲ ▼ </pre>	<pre> CONF I G ----- Shelf 0 Slot 14 ----- bdr 4:1R TRANSMIT PROCESSOR ----- RFDriveA 0 dB ▲ ▼ </pre>	<pre> CONF I G ----- Shelf 0 Slot 14 ----- bdr 4:1R TRANSMIT PROCESSOR ----- RFDriveB 0 dB ▲ ▼ </pre>	<pre> CONF I G ----- Shelf 0 Slot 14 ----- bdr 4:1R TRANSMIT PROCESSOR ----- RFDriveC 0 dB ▲ ▼ </pre>

Configuring the bdr Transmit Processor Using the ICIM, Continued

CONF I G		CONF I G	
Shelf	0	Shelf	0
Slot	14	Slot	14
-----		-----	
bdr 4:1R TRANSMIT PROCESSOR		bdr 4:1R TRANSMIT PROCESSOR	
-----		-----	
RFD riveD		Clk_Src	
0	dB	Indpend	
▲ ▼		▲ ▼	

Checking bdr Transmit Processor Alarms Using the ICIM

Alarm Data Display

The alarms generated by the Prisma II bdr 4:1 Redundant Transmit Processor are shown below.

Alarm	Alarm Condition	Indication	Possible Cause
FPGASIC	Indicates that the FPGASIC can not be read or written.	Fault	FPGASIC can not be read or written. Reseat module.
Power_In	Status of +24V and -5V power inputs.	Fault	Check power supplies. Make sure the module is fully seated in chassis.
+1_8VInt	1.8 Voltage fault	Fault	1.8 Voltage level internal to the receiver too high or low.
+3_3VInt	3.3 Voltage fault	Fault	3.3 Voltage level internal to the receiver too high or low.
ProcTemp	Processor temperature	Fault	Ensure chassis is within temperature specs.
OSM_Comm	Gets set when it is not possible to read and write to the EEPROM in an installed transmitter.	Fault	Ensure transmitter is fully seated. Remove and reinstall transmitter.
Las1Pres	Transmitter 1 is missing.	Fault	Ensure transmitter 1 is installed and fully seated.
Las1EOL	Laser 1 is near end of life.	Fault	Time to replace transmitter.
Las1Temp	Laser 1 temperature is out of spec.	Fault	Ensure transmitter is within temperature specs and laser has had a chance to stabilize.
Las2Pres	Transmitter 2 is missing.	Fault	Ensure transmitter is installed and fully seated.
Las2EOL	Laser 2 is near end of life.	Fault	Time to replace transmitter.
Las2Temp	Laser 2 temperature is out of spec.	Fault	Ensure transmitter is within temperature specs and laser has had a chance to stabilize.

Checking bdr Transmit Processor Alarms Using the ICIM, Continued

Alarm	Alarm Condition	Indication	Possible Cause
Las1Bias	Bias current of the laser in transmitter 1 is out of spec.	Minor L or H Major L or H	Re-seat transmitter.
Las2Bias	Bias current of the laser in transmitter 2 is out of spec.	Fault	Re-seat transmitter.
Clock100	Alarms when the 100 MHz clock does not lock on to the 100 MHz reference.	Fault	Ensure module Clk_Src has not been accidentally set to Slave. If in Slave mode make sure there is a valid 1 MHz reference present.
Clock125	Alarm when 125 MHz clock will not lock on 125 MHz reference.	Fault	Hardware failure.

Checking bdr Transmit Processor Alarms Using the ICIM, Continued

Checking Alarms

If the red ALARM LED on the front panel is blinking a minor alarm condition is indicated. If the red ALARM LED on the front panel is illuminated, a critical alarm condition is indicated.

Alarms fall into one of the following categories.

- Major low
- Minor low
- Minor high
- Major high

To check alarm conditions follow these steps.

1. From the MAIN menu, press the key to highlight the **Shelf** and **Slot** fields.
2. Press the key to address the **Shelf** number. Then press the key or the keys to scroll to the number of the desired shelf.
3. Press the key. The **Slot** field is highlighted.
4. Press the key or the key to scroll to the number of the desired slot.
5. Press the key. The **MODULE** menu is displayed on the ICIM.
6. Press the key. The module alarm conditions are displayed here.
7. Use the key or the key to scroll through alarm conditions until the desired alarm is displayed.
8. Monitor the alarm condition(s). Take appropriate action. Verify that all settings and thresholds relating to the alarm indication are set correctly to rule out an unintended alarm.
9. When finished, press the key. The display returns to the MAIN menu.

Checking bdr Transmit Processor Alarms Using the ICIM, Continued

Alarm Thresholds

Factory-set alarm thresholds for the Prisma II bdr 4:1 Redundant Transmit Processor are shown below. Alarm thresholds are not adjustable on this module.

Alarm	Function	Major Low Thold	Minor Low Thold	Minor High Thold	Major High Thold	Unit	Typical range
+1_8VInt	Internal 1.8 voltage	1.620	1.67	1.93	1.980	V DC	1.77 - 1.83
+3_3VInt	Internal 3.3 voltage	2.970	3.070	3.530	3.630	V DC	3.2 - 3.4
ProcTemp	Module temperature	-40	-30	80	85	°C	40-50
Las1Bias	Bias current of the laser in transmitter 1	5.0	8.0	32.5	40	mA	10 to 30
Las2Bias	Bias current of the laser in transmitter 2	5.0	8.0	32.5	40	mA	10 to 30
Las1Temp	Laser 1 temperature (cooled laser only)	-1.0	N/A	N/A	N/A	mA	0.00 to 0.15
Las2Temp	Laser 2 temperature (cooled laser only)	-1.0	N/A	N/A	N/A	mA	0.00 to 0.15
Las1EOL	Laser 1 end of life monitor	34	N/A	N/A	N/A	mA	34 mA for cooled lasers; 100 mA for uncooled lasers
Las2EOL	Laser 2 end of life monitor	34	N/A	N/A	N/A	mA	34 mA for cooled lasers; 100 mA for uncooled lasers

Checking bdr Transmit Processor Alarms Using the ICIM, Continued

bdr 4:1 Redundant Transmit Processor ALARM Menus

When a module's **ALARM** menu is selected, press the key or the key to scroll through alarms. Typical **ALARM** menus are shown below.

<pre> ALARMS ----- Shelf 0 Slot 14 ----- bdr 4:1R TRANSMIT PROCESSOR ----- FPGASIC Fault </pre>	<pre> ALARMS ----- Shelf 0 Slot 14 ----- bdr 4:1R TRANSMIT PROCESSOR ----- Power_In Fault </pre>	<pre> ALARMS ----- Shelf 0 Slot 14 ----- bdr 4:1R TRANSMIT PROCESSOR ----- +1_8 VInt Fault </pre>	<pre> ALARMS ----- Shelf 0 Slot 14 ----- bdr 4:1R TRANSMIT PROCESSOR ----- +3_3 VInt Fault </pre>
<pre> ALARMS ----- Shelf 0 Slot 14 ----- bdr 4:1R TRANSMIT PROCESSOR ----- Proc Temp Fault </pre>	<pre> ALARMS ----- Shelf 0 Slot 14 ----- bdr 4:1R TRANSMIT PROCESSOR ----- OSM_Comm Fault </pre>	<pre> ALARMS ----- Shelf 0 Slot 14 ----- bdr 4:1R TRANSMIT PROCESSOR ----- Las1Pres Fault </pre>	<pre> ALARMS ----- Shelf 0 Slot 14 ----- bdr 4:1R TRANSMIT PROCESSOR ----- Las1EOL Fault </pre>

Checking bdr Transmit Processor Alarms Using the ICIM, Continued

<p style="text-align: center;">ALARMS</p> <hr/> <p>Shelf 0 Slot 14</p> <hr/> <p>bdr 4:1R TRANSMIT PROCESSOR</p> <hr/> <p>Las1Temp Fault</p>	<p style="text-align: center;">ALARMS</p> <hr/> <p>Shelf 0 Slot 14</p> <hr/> <p>bdr 4:1R TRANSMIT PROCESSOR</p> <hr/> <p>Las2Pres Fault</p>	<p style="text-align: center;">ALARMS</p> <hr/> <p>Shelf 0 Slot 14</p> <hr/> <p>bdr 4:1R TRANSMIT PROCESSOR</p> <hr/> <p>Las2EOL Fault</p>	<p style="text-align: center;">ALARMS</p> <hr/> <p>Shelf 0 Slot 14</p> <hr/> <p>bdr 4:1R TRANSMIT PROCESSOR</p> <hr/> <p>Las2Temp MajorH</p>
<p style="text-align: center;">ALARMS</p> <hr/> <p>Shelf 0 Slot 14</p> <hr/> <p>bdr 4:1R TRANSMIT PROCESSOR</p> <hr/> <p>Las1Bias MajorL</p>	<p style="text-align: center;">ALARMS</p> <hr/> <p>Shelf 0 Slot 14</p> <hr/> <p>bdr 4:1R TRANSMIT PROCESSOR</p> <hr/> <p>Las2Bias MajorL</p>	<p style="text-align: center;">ALARMS</p> <hr/> <p>Shelf 0 Slot 14</p> <hr/> <p>bdr 4:1R TRANSMIT PROCESSOR</p> <hr/> <p>Cloc k100 Fault</p>	<p style="text-align: center;">ALARMS</p> <hr/> <p>Shelf 0 Slot 14</p> <hr/> <p>bdr 4:1R TRANSMIT PROCESSOR</p> <hr/> <p>Cloc k125 Fault</p>

Checking Manufacturing Data Using the ICIM

Manufacturing Data Display

The table below describes the manufacturing data available for this module.

Manufacturing Data	Explanation
Module Type	Cisco module type number.
Serial #	The alphanumeric device serial number.
Date Code	Code describing year and month of module manufacture.
Sw Ver (Software Version)	Core code software version.
Script Ver (Script Version)	Module software script version.
In Service Hours	Number of hours that the module has been used.
Spec Data	No special data for this module.
Restore Factory Defaults	Restores all factory default configuration settings.

Checking Manufacturing Data Using the ICIM, Continued

Checking Manufacturing Data

The manufacturing data (**MFG. DATA**) information listed above may be displayed on the ICIM menu. To access the module's manufacturing data, follow these steps.



1. From the MAIN menu, press the key to highlight the **Shelf** and **Slot** fields.
2. Press the key to address the **Shelf** number. Then press the key or the keys to scroll to the number of the desired shelf.
3. Press the key. The **Slot** field is highlighted.
4. Press the key or the key to scroll to the number of the desired slot.
5. Press the key. The MODULE menu for this module will be selected, as shown on the left below. Press the key to enter the start of the manufacturing data screens, as shown on the right below.

MODULE	MFG. DATA
-----	-----
Shelf 0	Shelf 0
Slot 14	Slot 14
-----	-----
bdr 4:1R	bdr 4:1R
TRANSMIT	TRANSMIT
PROCESSOR	PROCESSOR
-----	-----
Alarms	Module
1	Type
-----	-----
Mfg. Data	1008
▲ ▼	▲ ▼

6. The or keys allow you to scroll through the manufacturing data menus.

Checking Manufacturing Data Using the ICIM, Continued

MFG. DATA Screens

When the **MFG. DATA** screen is selected, the  key or the  key allows you to scroll through the manufacturing parameters specific to this module. Some typical **MFG. DATA** screens are show below.

```

MFG. DATA
-----
Shelf  0
Slot  14
-----
bdr 4:1R
TRANSMIT
PROCESSOR
-----
Module
Type

    1008

    ▲ ▼
    
```

```

MFG. DATA
-----
Shelf  0
Slot  14
-----
bdr 4:1R
TRANSMIT
PROCESSOR
-----
Serial #
!AAYCUAA
Date Code
H00

    ▲ ▼
    
```

```

MFG. DATA
-----
Shelf  0
Slot  14
-----
bdr 4:1R
TRANSMIT
PROCESSOR
-----
SW Ver
NCCB111
Script Ver
1

    ▲ ▼
    
```

```

MFG. DATA
-----
Shelf  0
Slot  14
-----
bdr 4:1R
TRANSMIT
PROCESSOR
-----
In Service
Hours

    10

    ▲ ▼
    
```

```

MFG. DATA
-----
Shelf  0
Slot  14
-----
bdr 4:1R
TRANSMIT
PROCESSOR
-----
Spec Data
Prisma II

    ▲ ▼
    
```

```

MFG. DATA
-----
Shelf  0
Slot  14
-----
bdr 4:1R
TRANSMIT
PROCESSOR
-----
Restore
Factory
Defaults

    ▲ ▼
    
```

Using the ICIM to Save the Configuration

Saving the Current Configuration

To save the current module configuration, follow these steps after every change.

1. After you have changed a parameter or entered data, press the **ENTER** key to save the changes and return to the MAIN menu.
2. If you do not save your changes for two minutes, or if you press the **SHIFT** **CAN** keys at the same time, changes are aborted and the display returns to the MAIN menu.

Configuration Complete

Once you have configured this module to your system's specifications using the ICIM and no alarms are indicated, no further action is necessary. The module operates without further input. Alarms, changes in operating parameters, electrical power fluctuations, or changes in system design may be cause for additional action.

Chapter 4

Operation Using the LCI Software

Overview

Introduction

The installation steps and the procedures in this chapter only apply if you are using the Local Craft Interface (LCI) software to operate the Prisma II bdr 4:1 Redundant Transmit Processor.

Scope of This Chapter

Included in this chapter are LCI installation instructions and detailed descriptions of how to use LCI to view and modify information for the transmitter.

In This Chapter

This chapter contains the following topics.

Topic	See Page
LCI Introduction	4-3
System Requirements	4-4
Obtaining and Installing the Prisma II Driver Upgrade	4-5
Installing LCI	4-6
Connecting Your Computer to the Chassis	4-10
Starting LCI	4-11
LCI Device Tree Overview	4-13
Accessing the Device Details Window	4-15

Overview, Continued

Topic	See Page
Checking the Operating Status	4-18
Configuring the bdr Transmit Processor	4-20
Checking bdr Transmit Processor Alarms	4-22
Checking Device Properties	4-24



WARNING:

Avoid damage to your eyes! Do not look into any optical connector while the system is active. Even if the unit is off, there may still be hazardous optical levels present.

LCI Introduction

LCI Function

The LCI software functions as a user interface for the Prisma II platform. The LCI software operates on a computer, which is connected to a Prisma II Chassis. Using the LCI software, you can configure and monitor the modules in the chassis the computer is connected to.

Important: Do not operate any Prisma II Chassis without a Fan Tray installed. If a Fan Tray is not installed in the Prisma II Chassis, the LCI software will not communicate with the power supplies in that chassis.

System Requirements

Introduction

You will need the following computer software and hardware to run the LCI software. Typically a laptop PC is used for portability.

Computer Requirements

- Pentium II 300 MHz processor or equivalent
- 128 MB RAM
- 10 MB available hard drive space
- 1.44 MB floppy drive
- CD-ROM Drive
- Windows 98 or Windows NT

Connecting the PC to the Prisma II Chassis

The required cable is a standard “off the shelf” DB9 Female to DB9 Male serial extension cable. The connectors are a serial 9-pin D-shell (EIA 574/232).

The Cisco part number for a six-foot DB9 Female to DB9 Male extension cable is 180143.

Obtaining and Installing the Prisma II Driver Upgrade

Required Software

To operate the Prisma II bdr 4:1 Redundant Transmit Processor and the Prisma II bdr 4:1 Redundant Receive Processor using the LCI software, you must have (in addition to Windows) the following Cisco software installed on your PC.

- LCI software version 1.4.3 or later
- Prisma II Driver Upgrade if using LCI version 1.4.3.

Important: If you are using LCI software version 1.4.3, it must be installed on your PC prior to installing the Prisma II Driver Upgrade. LCI software version 1.4.3 was shipped on CD-ROM with the 56-connector chassis and is also available at the Cisco web site shown below.

This upgrade is *not* required to operate the Prisma II bdr 4:1 Redundant Transmit and Receive Processors if you are using the Prisma II ICIM or any LCI software later than 1.4.3.

Downloading the Prisma II Driver Upgrade

To obtain the Prisma II Driver Upgrade, you must download the upgrade from the internet at the Cisco web site. The URL is:

<http://www.scientificatlanta.com/tncs/upgrades/upgrades.htm>

Internet access is required in order to obtain this software. Downloads may be made to any computer but must ultimately be installed on the PC running the LCI software.

Saving and Installing the Prisma II Driver Upgrade (LCI Software Version 1.4.3 ONLY)

To install this upgrade, follow the instructions below.

1. Ensure that LCI software version 1.4.3 is installed on your system. If not, install it before proceeding.
2. Access the web site shown above.
3. Click the **Prisma II Driver Upgrade** link.
4. At the prompt, save the file to a location of your choice on your system.
5. In Windows Explorer, double-click the saved file.
6. Follow the prompts of the install program. The Prisma II Driver Upgrade is installed in the proper location on your system. The LCI software is now ready to use with the Prisma II bdr 4:1 Redundant Transmit and Receive Processors.

Installing LCI

Introduction

This section describes how to install your LCI software.

Installing the LCI Software

To install the LCI software, follow these steps.

1. Close all programs that are running on your computer.
2. Insert the LCI CD-ROM into your CD-ROM drive.

Result: The LCI software installation program starts automatically. If the installation program does not start automatically, open Windows Explorer and double-click the file **setup.exe** on the LCI CD-ROM.

3. The Welcome screen opens. Click **Next**.

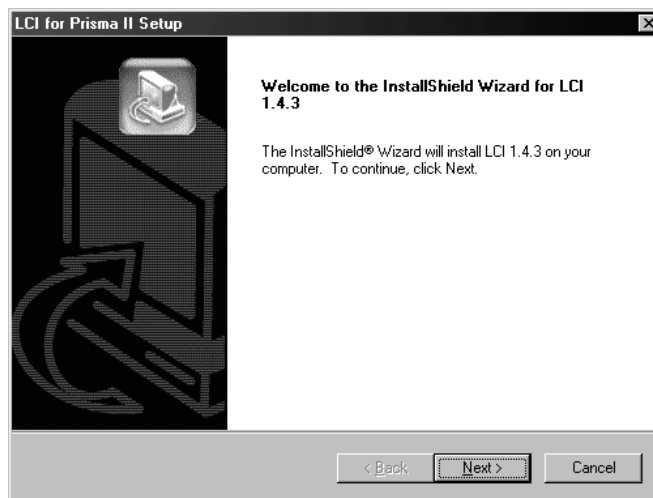

Result: The License Agreement screen opens.

Installing LCI, Continued

4. Click **Yes** to accept the license agreement.



Result: The License Agreement Confirmation dialog box opens.

5. Click **Yes**.

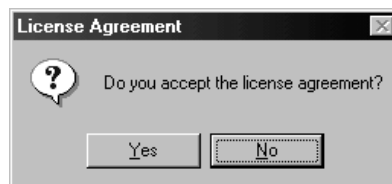

Note: The Destination Folder screen opens.

Installing LCI, Continued

6. Do you want to install the LCI software in the specified **Destination Folder**?
 - If **yes**, click **Next** to begin the installation, and go to step 10.
 - If **no**, go to step 7.

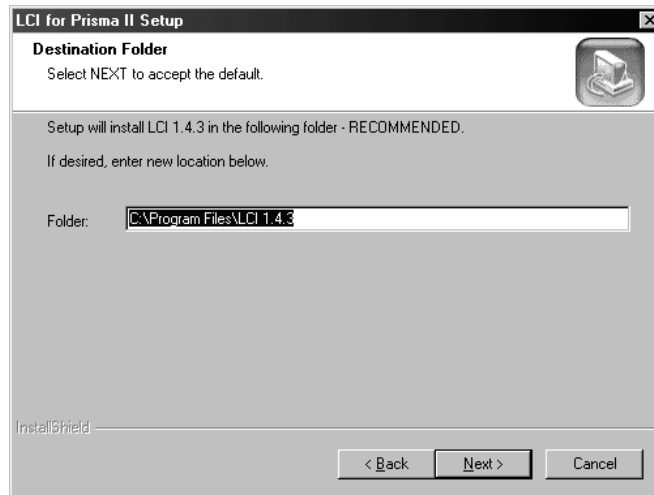

7. To specify where you want the LCI software to be installed, type the path in the text box of the **Folder:** field.
 8. Click **Next** to begin the installation.
- Note:** The last installation wizard screen opens after the installation is complete.

Installing LCI, Continued

9. Before you can use the LCI software, you must restart your computer. Choose whether to restart your computer now or later by selecting the appropriate option button.



10. Click **Finish**. After your computer is restarted, you can use the LCI software.
Important: If using LCI version 1.4.3 or earlier to operate the Prisma II bdr 4:1 Redundant Transmit or Prisma II bdr 4:1 Redundant Receive Processors, you must have the Prisma II Driver Upgrade installed on your PC. See **Obtaining and Installing the Prisma II Driver Upgrade** earlier in this chapter.

Connecting Your Computer to the Chassis

Introduction

Before you start the LCI software, you must first connect your computer to the chassis that contains the module(s) you want to communicate with.

Important: The LCI software communicates only with those modules located in the chassis your computer is attached to. To check other modules, you must connect your computer to the chassis they are located in.

Connecting to the Chassis

To connect your PC to the chassis, follow these steps.

1. Plug one end of a 9-pin serial extension cable into your computer.
2. Plug the other end of the cable into the LCI port. This port is labeled “Local Craft Interface”.

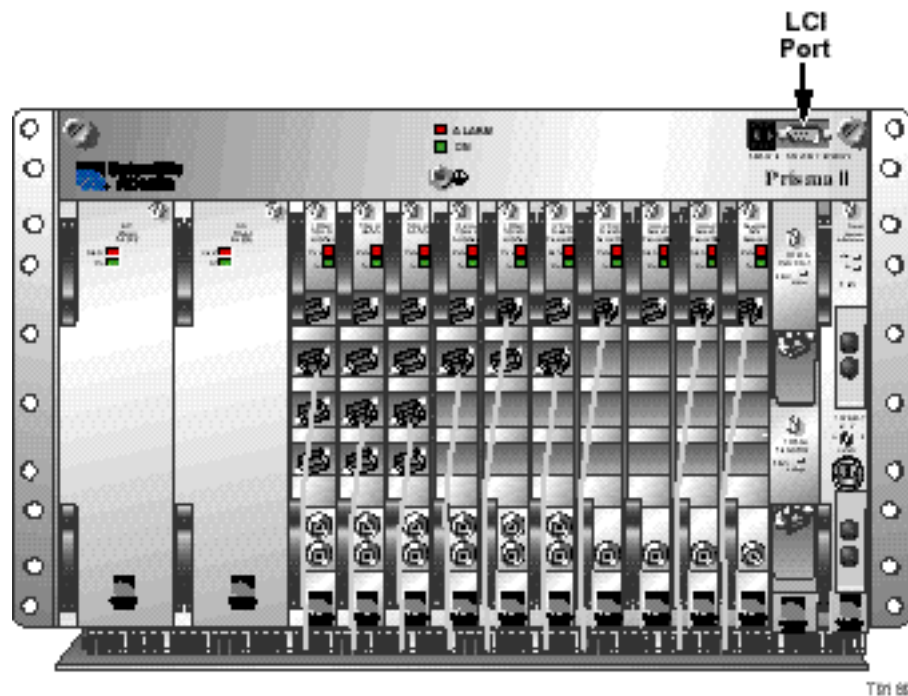

Starting LCI

Introduction

When you start the LCI software, it queries the devices (modules) located in the chassis that is connected to your computer. After this query process (referred to as the learn mode), the LCI software does the following for each device it finds.

- Represents the device in the device tree of the main LCI window.
- Makes the polling information available so you can check and configure various parameters.

Important: Your computer must be connected to the chassis before you start the LCI software. For instructions, refer to **Connecting Your Computer to the Chassis** earlier in this chapter.

Starting the LCI Software

To start the software, perform these steps.

1. Double-click the LCI icon on your Windows desktop.



Result: The LCI Main window opens and the LCI Detect Configuration window opens.

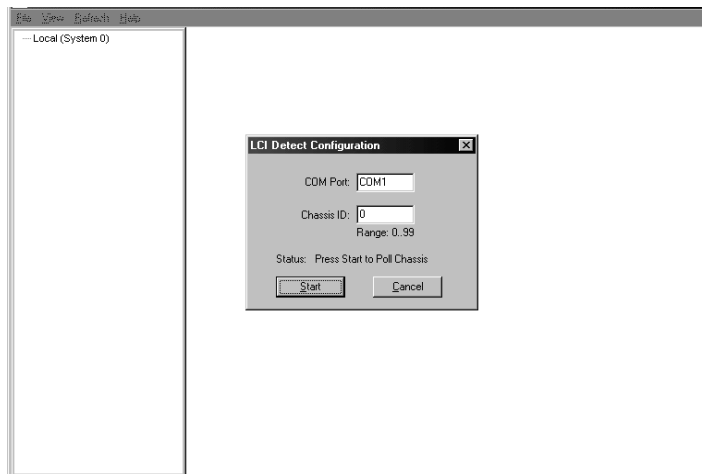

2. Verify the communication port displayed in the **Port** box. This is the port on your computer that the chassis is connected to.

To change the com port, type the word “com” and then the port number.

Note: To specify com port 1, type **COM1**.

Starting LCI, Continued

3. Verify that the Chassis ID is the same number that is dialed in on the Chassis ID switch on the front of the Prisma II Chassis which you are connected to.

To change the Chassis ID, type the number in the box.

Click **Start**.

Notes: The LCI software polls the Prisma II Chassis.

4. When the refresh is complete, click **OK**.

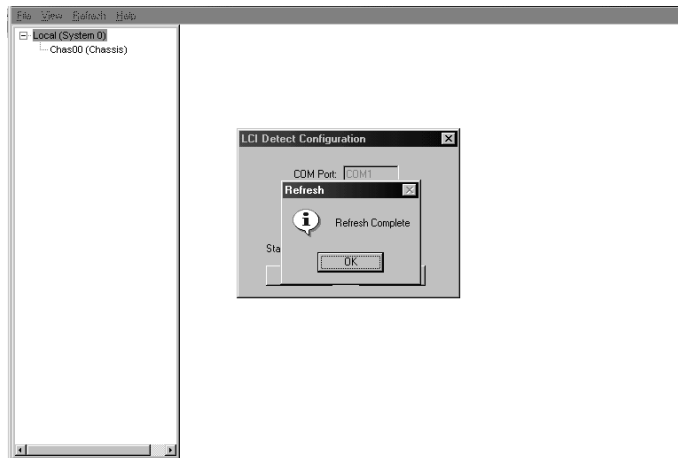

- The chassis and modules appear in the device tree of the main window of the LCI software.



LCI Device Tree Overview

Introduction

The main window of the LCI software contains a tree that represents your system in a hierarchical manner.



Device Tree

In the graphic above, the Device tree represents a PC connected to a chassis that contains five modules. The three tree levels are described in the following table.

Device Tree Level	Description
Local (System 0)	Computer being used
Chass00 (Chassis)	Chassis the computer is connected to
Sxx (Device name)	Module(s) located within the chassis. Each device is of the format <i>chassis slot location (device name)</i> . Example: In the graphic above, S14 (Transmitter) represents a Prisma II bdr 4:1 Redundant Transmit Processor that is located in slot 14 of the chassis.

LCI Device Tree Overview, Continued

Device Information

Information about a device (its parameters, alarms and statuses) is located in the Device Details window. Within the device tree, you can access this window using one of the following four methods:

- Double-click the chassis and select the device in the graphic that opens
- Right-click the chassis and select **Open** from the menu that opens
- Double-click the module
- Right-click the device and select **Details** from the menu that opens

Note: Although you can use the method that's most convenient for you, the procedures throughout this chapter are described using the right-click device technique.

For more information about each of these methods, refer to the next section, **Accessing the Device Details Window**.

Accessing the Device Details Window

Introduction

Information about a device (its parameters, alarms, and status) is located in the Device Details window. The graphic below shows the Device Details window for a Prisma II bdr 4:1 Redundant Transmit Processor.

Parameters								
Present Value	Present Status	Nominal Value	Minor Alarm Low-Limit	Minor Alarm High-Limit	Major Alarm Low-Limit	Major Alarm High-Limit		
Processor 1.8 Voltage	1.8	Normal	n/a	1.67	1.93	1.62	1.98	Volts
Processor 3.3 Voltage	3.3	Normal	n/a	3.07	3.53	2.97	3.63	Volts
Processor Temperature	38.8	Normal	n/a	-30	80	-40	85	deg-C
Transmitter 1 Laser Bias	24.2	Normal	n/a	6.0	70.0	3.0	80.0	mA
Transmitter 2 Laser Bias	24.5	Normal	n/a	6.0	70.0	3.0	80.0	mA

Alarms		Controls		Properties	
Summary Status	Normal	Internal Redundant Mode	Yes	Devtype Revision	1.00
Communication Status	Normal	Transmitter 1 Enable	Enable	Name	S14
Transmitter 1 Status	Normal	Transmitter 2 Enable	Enable	Graphic	
Transmitter 2 Status	Normal	RF Drive Stream A	0.0 dB	Service Name	
Transmitter 1 Laser End of Life Status	Normal	RF Drive Stream B	0.0 dB	Symbol	
Transmitter 2 Laser End of Life Status	Normal	RF Drive Stream C	0.0 dB	Device Location	
FPGASIC Status	Normal	RF Drive Stream D	0.0 dB	M&C-Scan	On-Scan
Transmitter Communication Status	Normal	Clock Source	Independent	Maintenance Mode	Normal
Clock Status 100 MHz	Normal			Poll Counter	2570
Clock Status 125 MHz	Normal			Script	
Power Supply Status	Normal			Address	14
				Port	COM1
				Description	bdr 4:1 Fixed Band Transm
				Software Revision	1.11
				Script Version	1
				Serial Number	SERIALJNU
				Time Of Service	0 Hrs
				Date Code	DATE
				Module Type	1011

Status	
Band Configuration	5-40MHz
Transmitter 1 Installed	Yes
Transmitter 2 Installed	Yes
Transmitter 1 Type	3
Transmitter 2 Type	3

Within the LCI device tree, you can access this window using one of the following four methods:

- Double-click the chassis and select the device in the graphic that opens
- Right-click the chassis and select **Open** from the menu that opens
- Double-click the module
- Right-click the device and select **Details** from the menu that opens

Note: Although you can use the method that's most convenient for you, the procedures throughout this chapter are described using the right-click device technique.

For more information about the device tree, refer to **LCI Device Tree Overview** earlier in this chapter.

Accessing the Device Details Window, Continued

Right-Click the Chassis

To access the Device Details window, perform these steps.

1. Right-click the chassis, and click **Open**.

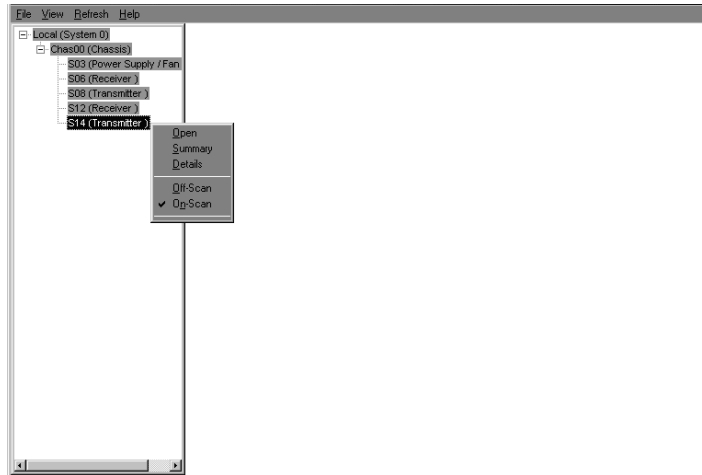

Result: A graphic representation of the chassis opens.

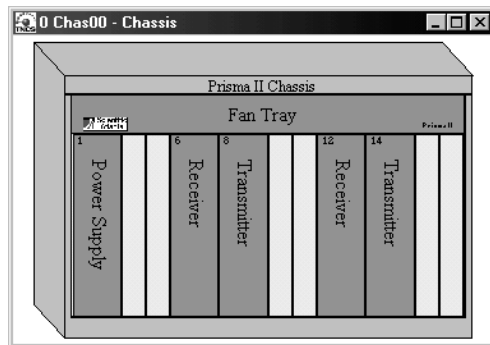

Accessing the Device Details Window, Continued

- Double-click the device whose information you want to view and/or configure.

Result: The Device Details window opens.

bdr 4:1 Fixed Band Transmit Processor

<u>Parameters</u>							
Present Value	Present Status	Nominal Value	Minor-Alarm Low-Limit	Minor-Alarm High-Limit	Major-Alarm Low-Limit	Major-Alarm High-Limit	
Processor 1.8 Voltage	1.8	Normal	n/a	1.67	1.93	1.98	Volts
Processor 3.3 Voltage	3.3	Normal	n/a	3.07	3.53	2.97	Volts
Processor Temperature	38.8	Normal	n/a	-30	80	-40	deg-C
Transmitter 1 Laser Bias	24.2	Normal	n/a	6.0	70.0	3.0	mA
Transmitter 2 Laser Bias	24.5	Normal	n/a	6.0	70.0	3.0	mA

Alarms

- Summary Status: Normal
- Communication Status: Normal
- Transmitter 1 Status: Normal
- Transmitter 2 Status: Normal
- Transmitter 1 Laser End of Life Status: Normal
- Transmitter 2 Laser End of Life Status: Normal
- FPGASIC Status: Normal
- Transmitter Communication Status: Normal
- Clock Status 100 MHz: Normal
- Clock Status 125 MHz: Normal
- Power Supply Status: Normal

Controls

- Internal Redundant Mode: Yes
- Transmitter 1 Enable: Enable
- Transmitter 2 Enable: Enable
- RF Drive Stream A: 0.0 dB
- RF Drive Stream B: 0.0 dB
- RF Drive Stream C: 0.0 dB
- RF Drive Stream D: 0.0 dB
- Clock Source: Independent

Properties

- Devtype Revision: 1.00
- Name: S14
- Graphic: [None]
- Service Name: [None]
- Symbol: [None]
- Device Location: [None]
- M&C-Scan: On-Scan
- Maintenance Mode: Normal
- Poll Counter: 2570
- Script: [None]
- Address: 14
- Port: COM1
- Description: bdr 4:1 Fixed Band Transmit
- Software Revision: 1.11
- Script Version: 1
- Serial Number: SERIALNU
- Time Of Service: 0 Hrs
- Date Code: DATE
- Module Type: 1011

Status

- Band Configuration: 5-40MHz
- Transmitter 1 Installed: Yes
- Transmitter 2 Installed: Yes
- Transmitter 1 Type: 3
- Transmitter 2 Type: 3

- Proceed with viewing and/or configuring information.

Checking the Operating Status

Introduction

Using the LCI software, you can check the status of all operating parameters of the bdr Transmit Processor.

Monitored Parameters

The table below describes the monitored parameters for the bdr Transmit Processor.

Parameter	Units	Function
Module 1.8 Voltage	V	1.8 Voltage level internal to the processor.
Module 3.3 Voltage	V	3.3 Voltage level internal to the processor.
Module Temperature	°C	Displays processor temperature.
Transmitter 1 Laser Bias	mA	Displays laser 1 bias current.
Transmitter 2 Laser Bias	mA	Displays laser 2 bias current.
Band Configuration	MHz	Displays transmitter bandwidth
Transmitter 1 Installed	Yes/ No	Indicates if transmitter 1 is installed.
Transmitter 2 Installed	Yes/ No	Indicates if transmitter 2 is installed.
Transmitter 1 Type	0 or 3	Indicates what type transmitter is installed. 0 = 1550 nm cooled laser transmitter 3 = Uncooled 1550 nm or 1310 nm laser transmitter
Transmitter 2 Type	0 or 3	Indicates what type transmitter is installed. 0 = 1550 nm cooled laser transmitter 3 = Uncooled 1550 nm or 1310 nm laser transmitter

Checking the Operating Status, Continued

Checking the Operating Status

To monitor the Prisma II bdr Transmit Processor operating parameters, follow these steps.

1. Access the Device Details window. The monitored parameters are displayed under **Parameters** and **Status**.

bdr 4:1 Fixed Band Transmit Processor

Parameters

	Present Value	Present Status	Nominal Value	Minor-Alarm Low-Limit	Minor-Alarm High-Limit	Major-Alarm Low-Limit	Major-Alarm High-Limit	
Processor 1.8 Voltage	1.8	Normal	n/a	1.67	1.93	1.62	1.98	Volts
Processor 3.3 Voltage	3.3	Normal	n/a	3.07	3.53	2.97	3.63	Volts
Processor Temperature	38.8	Normal	n/a	-30	80	-40	85	deg-C
Transmitter 1 Laser Bias	24.2	Normal	n/a	6.0	70.0	3.0	80.0	mA
Transmitter 2 Laser Bias	24.5	Normal	n/a	6.0	70.0	3.0	80.0	mA

Alarms

Summary Status	Normal
Communication Status	Normal
Transmitter 1 Status	Normal
Transmitter 2 Status	Normal
Transmitter 1 Laser End of Life Status	Normal
Transmitter 2 Laser End of Life Status	Normal
FPGASIC Status	Normal
Transmitter Communication Status	Normal
Clock Status 100 MHz	Normal
Clock Status 125 MHz	Normal
Power Supply Status	Normal

Controls

Internal Redundant Mode	Yes
Transmitter 1 Enable	Enable
Transmitter 2 Enable	Enable
RF Drive Stream A	0.0 dB
RF Drive Stream B	0.0 dB
RF Drive Stream C	0.0 dB
RF Drive Stream D	0.0 dB
Clock Source	Independent

Properties

Devtype Revision	1.00
Name	S14
Graphic	
Service Name	
Symbol	
Device Location	
M&C-Scan	On-Scan
Maintenance Mode	Normal
Poll Counter	2570
Script	
Address	14
Port	COM1
Description	bdr 4:1 Fixed Band Transm
Software Revision	1.11
Script Version	1
Serial Number	SERIALNU
Time Of Service	0 Hrs
Date Code	DATE
Module Type	1011

Status

Band Configuration	5-40MHz
Transmitter 1 Installed	Yes
Transmitter 2 Installed	Yes
Transmitter 1 Type	3
Transmitter 2 Type	3

2. Proceed with checking the operating status.

Configuring the bdr Transmit Processor

Introduction

Using the LCI software, you can configure the parameters listed below.

Configurable Parameters

Configurable parameters for the Prisma II bdr Transmit Processor are listed below.

Parameter	Function	Values	Default
Internal Redundant Mode	Internal Redundant mode. When set to Yes , the module will generate an alarm if either transmitter is removed.	Yes or No	Yes
Transmitter 1 Enable	Controls whether laser 1 is enabled or disabled. If Disable , laser 1 will be forced off. If Enable , this control will allow the laser to operate but will be subject to transmitter safeguards that prevent the laser from operating (e.g., when the wavelength would be out of specification).	Enable or Disable	Enable
Transmitter 2 Enable	Controls whether laser 2 is enabled or disabled. If Disable , laser 1 will be forced off. If Enable , this control will allow the laser to operate but will be subject to transmitter safeguards that prevent the laser from operating (e.g., when the wavelength would be out of specification).	Enable or Disable	Enable
RF Drive Stream A RF Drive Stream B RF Drive Stream C RF Drive Stream D	Sets the amount of RF attenuation for channel A, B, C, and D.	0 dB to 10.0 dB in 0.1 dB increments	0.0 dB
Clock Source	Independent - Transmitter generates the clock signal but does not send it outside the module. Master - Transmitter generates it's own clock signal and sends it out. Slave - Uses the clock input supplied from the backplane, typically from another transmitter in Master mode. If the clock is not present clock alarms are generated.	Indpend, Master, or Slave	Independent

Configuring the bdr Transmit Processor, Continued

Configuring Parameters

To configure the parameters, follow these steps.

1. Access the Device Details window. The Device Details window opens.

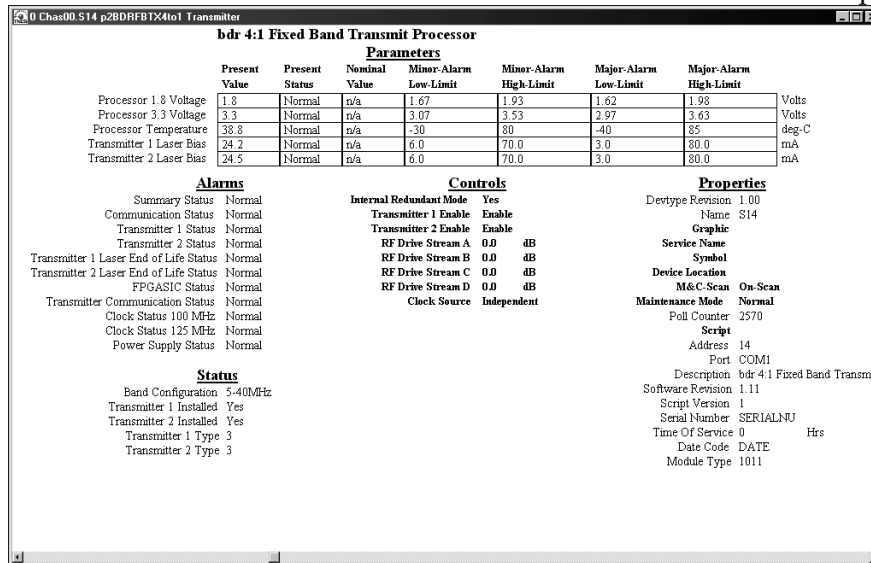

2. Under **Controls**, double-click the parameter you want to configure.

Result: The Change Value dialog box opens. The graphic below shows the dialog box for the Internal Redundant Mode parameter.

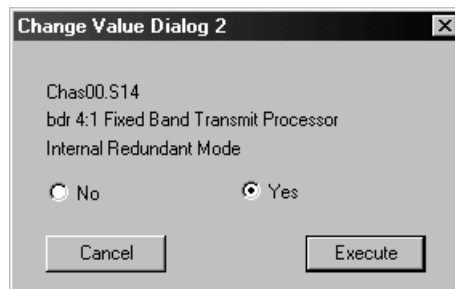

3. Depending on the parameter you chose, select or type a new value.
4. Click **Execute**.

Result: The new value appears next to the parameter.

Checking bdr Transmit Processor Alarms

Introduction

Alarms that you can check using the LCI software are listed below.

Alarm	Alarm Condition	Indication	Possible Cause
Processor 1.8 Voltage	1.8 Voltage fault	Alarm	1.8 Voltage level internal to the receiver too high or low.
Processor 3.3 Voltage	3.3 Voltage fault	Alarm	3.3 Voltage level internal to the receiver too high or low.
Processor Temperature	Temperature too high or low	Alarm	Module temperature too high or low.
Transmitter 1 Laser bias	Bias current of the laser in transmitter 1 is out of spec.	Alarm	Re-seat transmitter.
Transmitter 2 Laser bias	Bias current of the laser in transmitter 2 is out of spec.	Alarm	Re-seat transmitter.
Summary Status	Indicates if any parameter is in alarm	Alarm	Dependant on specific alarm.
Communication Status	Processor not communicating with the transmitter	Alarm	Reseat or replace the transmitter.
Transmitter 1 Status	Transmitter 1 not present	Alarm	Transmitter 1 not present.
Transmitter 2 Status	Transmitter 2 not present	Alarm	Transmitter 2 not present.
Transmitter 1 Laser End of LifeStatus	Laser 1 is near end of life.	Alarm	Laser bias increase due to age. Time to replace transmitter.
Transmitter 2 Laser End of LifeStatus	Laser 2 is near end of life.	Alarm	Laser bias increase due to age. Time to replace transmitter.
FPGA SIC Status	Indicates that the FPGASIC can not be read or written.	Alarm	Indicates the FPGA has stopped. Unit needs repair.
Transmitter Communication Status	Processor not communicating with the transmitter	Alarm	Reseat or replace the transmitter.
Transmitter 1 Laser temperature	Laser temperature of transmitter 1 is out of specification.	Alarm	Chassis fans not operating.

Checking bdr Transmit Processor Alarms, Continued

Transmitter 2 Laser temperature	Laser temperature of transmitter 2 is out of specification.	Alarm	Chassis fans not operating.
Clock Status 100 MHz	Internal clock generator fault	Alarm	Check for slave mode. Unit may need repair.
Clock Status 125 MHz	Internal clock generator fault	Alarm	Unit needs repair.
Power Supply Status	Power Supply Status	Alarm	Module not fully seated. Check power supply.

Alarms Limits

Alarms limits fall into one of the following categories.

- Major low
- Minor low
- Minor high
- Major high

Checking Alarms

To check a parameter's alarm status, perform these steps.

1. Access the Device Details window. The alarms are shown under **Parameters** and **Alarms**.

The screenshot shows the configuration window for a bdr 4:1 Fixed Band Transmit Processor. It is divided into several sections:

- Parameters:** A table with columns for Present Value, Present Status, Nominal Value, Minor-Alarm Low-Limit, Minor-Alarm High-Limit, Major-Alarm Low-Limit, and Major-Alarm High-Limit. Parameters include Processor 1.8 Voltage, Processor 3.3 Voltage, Processor Temperature, Transmitter 1 Laser Bias, and Transmitter 2 Laser Bias.
- Alarms:** A list of alarm statuses such as Summary Status, Communication Status, Transmitter 1 Status, Transmitter 2 Status, Transmitter 1 Laser End of Life Status, Transmitter 2 Laser End of Life Status, FPGASIC Status, Transmitter Communication Status, Clock Status 100 MHz, Clock Status 125 MHz, and Power Supply Status.
- Controls:** Settings for Internal Redundant Mode, Transmitter 1 Enable, Transmitter 2 Enable, RF Drive Stream A, B, C, and D, and Clock Source.
- Properties:** Information including Devtype Revision, Name, Service Name, Symbol, Device Location, M&C-Scan, On-Scan, Maintenance Mode, Poll Counter, Script, Address, Port, Description, Software Revision, Script Version, Serial Number, Time Of Service, Date Code, and Module Type.
- Status:** Information about Band Configuration, Transmitter 1 and 2 installation status, and Transmitter 1 and 2 Type.

2. If any of the parameters are in alarm, take the corrective action you deem necessary.

Checking Device Properties

Introduction

Using the LCI software, you can check the properties of the transmit processor.

Device Properties

The table below describes the properties available for this device.

Properties	Explanation
Port	The COM port on the PC used to connect to LCI
Description	Description of the device
Software Revision	Core code software version
Script Version	Device software script version
Serial Number	The alphanumeric device serial number
Time of Service	Number of hours device has been in operation
Date Code	Code describing year and month of manufacture
Module Type	Cisco device type number

Checking Device Properties, Continued

Checking Properties

To access the module's properties, perform these steps.

1. Access the Device Details window. The device properties are displayed under **Properties**.

The screenshot shows a window titled "bdr 4:1 Fixed Band Transmit Processor" with the following content:

Parameters

	Present Value	Present Status	Nominal Value	Minor-Alarm Low-Limit	Minor-Alarm High-Limit	Major-Alarm Low-Limit	Major-Alarm High-Limit	
Processor 1.8 Voltage	1.8	Normal	n/a	1.67	1.93	1.62	1.98	Volts
Processor 3.3 Voltage	3.3	Normal	n/a	3.07	3.53	2.97	3.63	Volts
Processor Temperature	38.8	Normal	n/a	-30	80	-40	85	deg-C
Transmitter 1 Laser Bias	24.2	Normal	n/a	6.0	70.0	3.0	80.0	mA
Transmitter 2 Laser Bias	24.5	Normal	n/a	6.0	70.0	3.0	80.0	mA

Alarms

- Summary Status: Normal
- Communication Status: Normal
- Transmitter 1 Status: Normal
- Transmitter 2 Status: Normal
- Transmitter 1 Laser End of Life Status: Normal
- Transmitter 2 Laser End of Life Status: Normal
- FPGASIC Status: Normal
- Transmitter Communication Status: Normal
- Clock Status 100 MHz: Normal
- Clock Status 125 MHz: Normal
- Power Supply Status: Normal

Controls

- Internal Redundant Mode: Yes
- Transmitter 1 Enable: Enable
- Transmitter 2 Enable: Enable
- RF Drive Stream A: 0.0 dB
- RF Drive Stream B: 0.0 dB
- RF Drive Stream C: 0.0 dB
- RF Drive Stream D: 0.0 dB
- Check Source: Independent

Properties

- Devtype Revision: 1.00
- Name: S14
- Graphic: [None]
- Service Name: [None]
- Symbol: [None]
- Device Location: [None]
- M&C-Scan: On-Scan
- Maintenance Mode: Normal
- Poll Counter: 2570
- Script: [None]
- Address: 14
- Port: COM1
- Description: bdr 4:1 Fixed Band Transmit
- Software Revision: 1.11
- Script Version: 1
- Serial Number: SERIALNU
- Time Of Service: 0 Hrs
- Date Code: DATE
- Module Type: 1011

Status

- Band Configuration: 5-40MHz
- Transmitter 1 Installed: Yes
- Transmitter 2 Installed: Yes
- Transmitter 1 Type: 3
- Transmitter 2 Type: 3

2. Proceed with viewing the properties .

Chapter 5

Maintenance and Troubleshooting

Overview

Introduction

This chapter provides information to assist you in maintaining and troubleshooting the Prisma II bdr 4:1 Redundant Transmit Processor.

Qualified Personnel

Only appropriately qualified and trained personnel should attempt to troubleshoot this product.



WARNING:

Allow only qualified personnel to install, operate, maintain, or service this product. Otherwise, personal injury or equipment damage may occur.

In This Chapter

This chapter contains the following topics.

Topic	See Page
Module Maintenance	5-2
General Troubleshooting Information	5-3
Troubleshooting Alarm Conditions	5-4
Troubleshooting LCI	5-7
Cleaning Fiber-Optic Connectors	5-13

Module Maintenance

Maintaining the Prisma II Module

To extend the life of the module and ensure optimal performance, the following maintenance is recommended.

Frequency	Maintenance Required
Weekly	<ul style="list-style-type: none">• Check all parameters and test points.• Record data.• Make repairs and adjustments as needed.
Quarterly	<ul style="list-style-type: none">• Make sure all cables are mated properly.• Inspect cables for stress and chafing.• Make sure all retaining screws are tight.
When needed	Carefully clean the module with a soft cloth that is dampened with mild detergent.

General Troubleshooting Information

Introduction

This troubleshooting information describes the most common alarms and gives typical symptoms, causes, and items to check before consulting us.

Equipment Needed

You need fiber connector cleaning materials to clean fiber connectors.

Additional Assistance

If you need additional assistance, telephone one of our Technical Service Centers or your local sales subsidiary. The Customer Support section in Chapter 6 contains a list of telephone numbers.

Troubleshooting



WARNING:

Avoid electric shock and damage to this product! Do not open the enclosure of this product. There are no user-serviceable parts inside. Refer servicing to qualified service personnel.

Refer to the following section, **Troubleshooting Alarm Conditions**, to identify and correct module faults.

Troubleshooting Alarm Conditions

ICIM Alarm Conditions

If the red ALARM indicator is illuminated or is blinking, check the ICIM to determine the cause of the alarm. Blinking = minor alarm, steady illumination = major alarm.

Alarm Conditions Displayed by the ICIM

The alarms displayed by the ICIM for this module are shown below.

Alarm	Alarm Condition	Indication	Possible Cause
Las1Temp	Laser 1 temperature is out of spec.	Fault	Ensure transmitter is within temperature specs and laser has had a chance to stabilize.
Las2Pres	Transmitter 2 is missing.	Fault	Ensure transmitter is installed and fully seated.
Las2EOL	Laser 2 is near end of life.	Fault	Time to replace transmitter.
Las2Temp	Laser 2 temperature is out of spec.	Fault	Ensure transmitter is within temperature specs and laser has had a chance to stabilize.
LasBias1	Bias current of the laser in transmitter 1.	Minor L or H Major L or H	Re-seat sub-module.
LasBias2	Bias current of the laser in transmitter 2.	Fault	Re-seat sub-module.
Clock100	Alarms when the 100 MHz clock does not lock on to the 100 MHz reference.	Fault	Ensure module Clk_Src has not been accidentally set to Slave. If in Slave mode make sure there is a valid 1 MHz reference present.
Clock125	Alarm when 125 MHz clock will not lock on 125 MHz reference.	Fault	Hardware failure.

Troubleshooting Alarm Conditions, Continued

Alarm Conditions Displayed on the LCI and TNCS Software

Alarms that you can check using the LCI or TNCS software are listed below.

Introduction

Alarms that you can check using the LCI software are listed below.

Alarm	Alarm Condition	Indication	Possible Cause
Processor 1.8 Voltage	1.8 Voltage fault	Alarm	1.8 Voltage level internal to the receiver too high or low.
Processor 3.3 Voltage	3.3 Voltage fault	Alarm	3.3 Voltage level internal to the receiver too high or low.
Processor Temperature	Temperature too high or low	Alarm	Module temperature too high or low.
Transmitter 1 Laser bias	Bias current of the laser in transmitter 1 is out of spec.	Alarm	Re-seat transmitter.
Transmitter 2 Laser bias	Bias current of the laser in transmitter 2 is out of spec.	Alarm	Re-seat transmitter.
Summary Status	Indicates if any parameter is in alarm	Alarm	Dependant on specific alarm.
Communication Status	Processor not communicating with the transmitter	Alarm	Reseat or replace the transmitter.
Transmitter 1 Status	Transmitter 1 not present	Alarm	Transmitter 1 not present.
Transmitter 2 Status	Transmitter 2 not present	Alarm	Transmitter 2 not present.
Transmitter 1 Laser End of LifeStatus	Laser 1 is near end of life.	Alarm	Laser bias increase due to age. Time to replace transmitter.
Transmitter 2 Laser End of LifeStatus	Laser 2 is near end of life.	Alarm	Laser bias increase due to age. Time to replace transmitter.
FPGA SIC Status	Indicates that the FPGASIC can not be read or written.	Alarm	Indicates the FPGA has stopped. Unit needs repair.

Troubleshooting Alarm Conditions, Continued

Transmitter Communication Status	Processor not communicating with the transmitter	Alarm	Reseat or replace the transmitter.
Clock Status 100 MHz	Internal clock generator fault	Alarm	Check for slave mode. Unit may need repair.
Clock Status 125 MHz	Internal clock generator fault	Alarm	Unit needs repair.
Power Supply Status	Power Supply Status	Alarm	Module not fully seated. Check power supply.

Troubleshooting LCI

Introduction

When you start the LCI software, it queries the modules located in the chassis that is connected to your laptop computer. After this query process (referred to as the Detect Configuration), the LCI software displays the modules in its module tree.

This section describes the steps to take if the chassis and installed devices do not display.

If Chassis Does Not Display in the Module Tree

When the Prisma II Chassis does not display in the module tree, the LCI screen will appear as shown here:

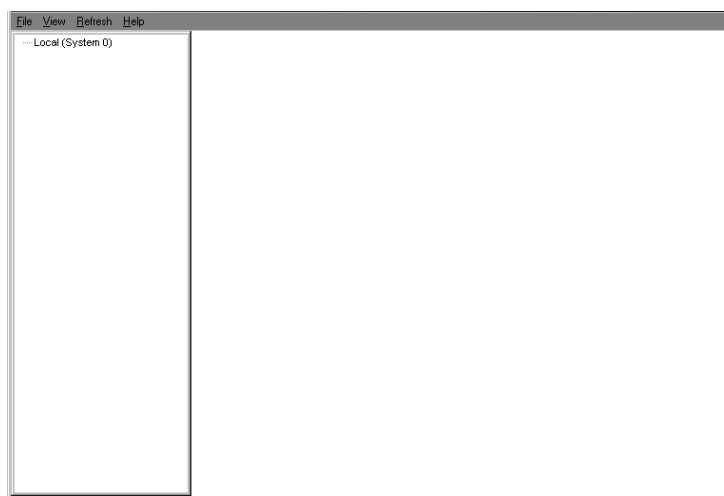

If the chassis is powered-up and properly connected to the PC and the LCI software is operating, and is not displayed in the module tree; the cause may be the result of one of the following two conditions:

- The cable that connects the chassis to your computer is plugged in to a different communications port than the one specified in the LCI Detect Configuration window. See **Specifying the Correct Communications Port** on the following page.
- The Chassis ID number entered in the LCI Detect Configuration window does not agree with the Chassis ID switch located on the front of the Prisma II Chassis. See **Specifying the Correct Chassis ID** on the following page.

Either of the above conditions results in the LCI software not being able to communicate with the Prisma II Chassis.

Troubleshooting LCI, Continued

Specifying the Correct Communications Port

Follow these steps to specify the correct communications port and chassis ID.

1. In the LCI menu bar, right-click **Local (System0)**. Click **Open** on the sub-menu.

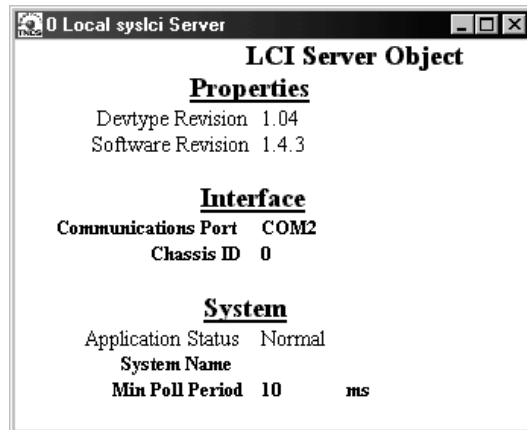

Result: The LCI Server Object window displays.

2. Verify that the **Communications Port** setting is the port on the PC actually used to connect to the Prisma II Chassis.
 - If the correct port is shown, this is not the problem. Proceed to **Specifying the Correct Chassis ID**.
 - If the correct port is not shown, proceed with step 3 of this procedure.

Troubleshooting LCI, Continued

- Under **Interface**, double-click **Communications Port**. In the **COM Port** field, enter the number of the COM Port actually in use connecting the PC to the Prisma II Chassis. **Example:** To specify com port 1, type **COM1**. The designated com port number displays in the **COM Port** field.

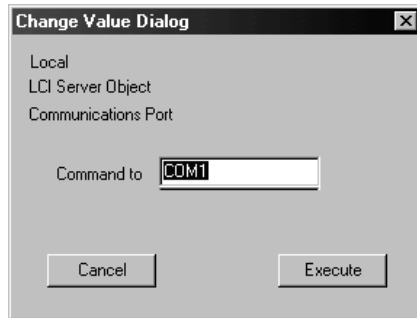

- Click **Execute**.

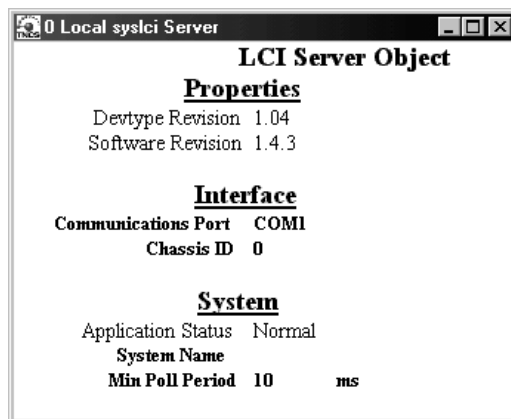

Result: The LCI Server Object window displays showing the correct COM Port.

- In the command bar, click **Refresh**.

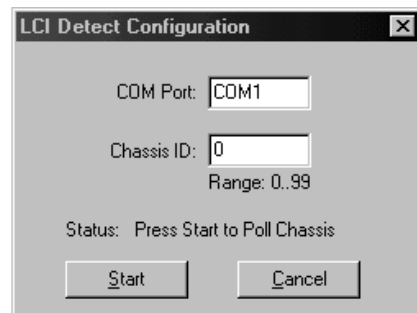

The **LCI Detect Configuration** window displays. Click **Start**.

Troubleshooting LCI, Continued

- The chassis should now display in the module tree as shown below. If not, proceed to **Specifying the Correct Chassis ID**.

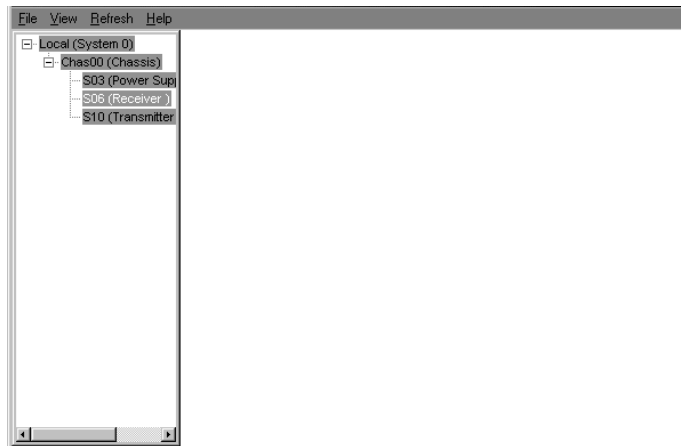

Specifying the Correct Chassis ID

If the Chassis ID number in the LCI Detect Configuration window does not agree with the number set in the Chassis ID switch on the front of the Prisma II Chassis, the software will not recognize the chassis.

In this case, you must change the Chassis ID field in the LCI Detect Configuration window in order for the LCI software to recognize the chassis. Follow these steps to specify the correct Chassis ID number.

- In the LCI menu bar, right-click **Local (System0)**. Click Open on the sub-menu.

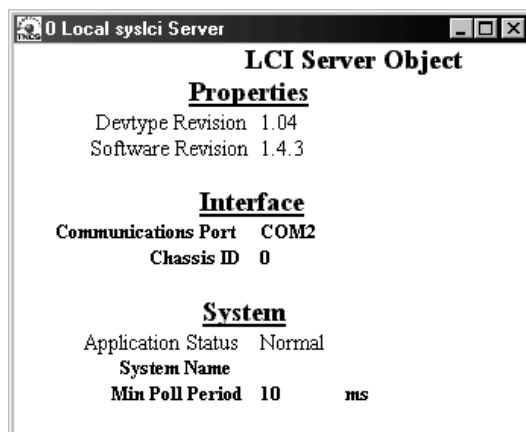

Troubleshooting LCI, Continued

2. Verify that the Chassis ID number matches the number on the Chassis ID switch on the front of the Prisma II Chassis.
 - If the LCI Server Object window shows the same Chassis ID number as the switch, you must re-initiate power to the Prisma II Chassis. See note below.
 - If the software shows a different Chassis ID number is shown, double-click **Chassis ID**, enter the number from the front of the Prisma II Chassis ID switch, and click **Execute**.

Note: If the switch on the front of the Prisma II Chassis was changed after the chassis was powered up, you will have to power-down, then power-up the chassis. However, if an ICIM is installed in the chassis, you can implement the **Update Address** command using the ICIM key. This allows the modules to identify their correct location to the LCI software (and the ICIM).

Not All of the Modules Display in the Module Tree

If some, but not all, of your modules display in the module tree, the cause may be that a device has been added since the software last polled the chassis.

Follow these steps to refresh the display.

1. In the command bar, click **Refresh**.

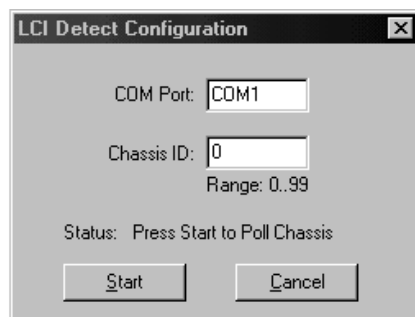

Result: The LCI Detect Configuration window displays.

Troubleshooting LCI, Continued

2. If the **COM Port** and the **Chassis ID** are set correctly, press **Start**. When finished, the Refresh window displays. Click **OK**.



If the **COM Port** or the **Chassis ID** are set incorrectly, follow the previous procedures, **Specifying the Correct Communications Port** and **Specifying the Correct Chassis ID**. Refresh again.

3. Exit LCI and then restart it for all changes to take effect.

Result: All of the installed modules should now display in the module tree.

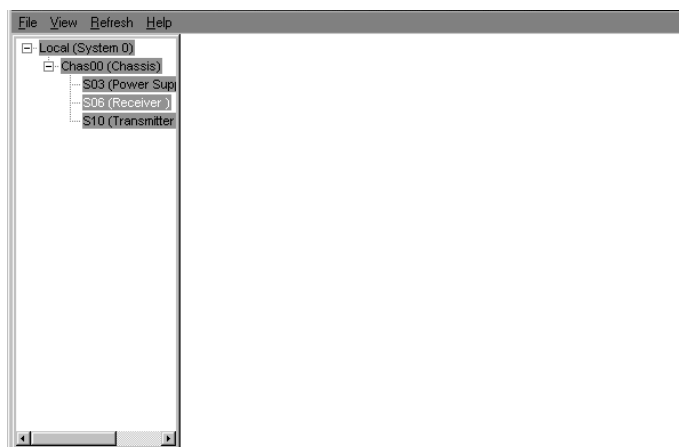

Cleaning Fiber-Optic Connectors

Introduction

Clean fiber-optic connectors can help prevent interconnect problems and therefore aid system performance. When optical connectors are disconnected and reconnected, the fiber surface can become dirty or scratched. The goal of cleaning the fiber optic connectors is to remove all dust and contaminants without leaving any residue behind.

Equipment Needed

You will need the following equipment to clean the ends of fiber optic connectors.

- Optical-grade (91%) isopropyl alcohol
- Lint free wipes
- Compressed air also called “canned air”

Tips for Optimal Fiber-Optic Connector Performance

To ensure optimal connector performance, follow these guidelines.

- Connect or disconnect optical connectors only when necessary
- Always use compressed air before cleaning the fiber optic connectors
- Use end caps on connectors when they are not in use
- Always use compressed air to clean the end caps
- Use optical-grade isopropyl alcohol of at least 91% or greater. Anything less than 91% isopropyl, may leave a film on the fiber surface, creating more problems
- Do not contaminate your alcohol supply. Use a fountain pump, or even better, a sprayer. Do not put used alcohol back into the main container
- Use only lint-free wipes, never use “Kleenex-type” tissues
- If you have any degraded signal problems, clean the fiber optic connector

Cleaning Optical Connectors

To clean the optical connector, follow these steps.

1. Remove loose dirt or dust from the end of the connector by using compressed air (canned air) to blow dirt off the fiber and the connector.
2. Dampen a lint-free wipe with optical-grade (91%) isopropyl alcohol. If no wipes are available, use our ferrule cleaner, part number 468517.
3. Wipe the end of the connector on the lint-free wipe.
4. Inspect the end of the connector for obvious contamination.
5. Mate the connector with an adapter or cover with an end cap.

Chapter 6

Customer Information

If You Have Questions

If you have technical questions, call Cisco Services for assistance. Follow the menu options to speak with a service engineer.

Access your company's extranet site to view or order additional technical publications. For accessing instructions, contact the representative who handles your account. Check your extranet site often as the information is updated frequently.

Optoelectronic Glossary

Term, Acronym, Abbreviation	Meaning
A	Ampere (amp) is the unit of measure for electrical current.
AC	Alternating current
ADC	Analog to digital
Addressable	The ability to control an individual unit in a system of many similar units.
AFC	Automatic Frequency Control
AGC	Automatic Gain Control
AM	Amplitude Modulation
Amplifier Cascade	Two or more amplifiers in a series, the output of one feeding the input of another.
APC	Automatic phase control
APD	Avalanche Photodiode. Avalanche refers to the gain mechanism internal to the photodiode, where 1 photon results in many electrons, as opposed to a PIN photodiode where 1 photon results in 1 electron.
ASIC	Application Specific Integrated Circuit
Attenuation	A decrease in signal magnitude occurring in transmission from one point to another or in passing through a loss medium.
Attenuator	A device designed to reduce signal strength by an amount specified in dB.
ATX	Addressable transmitter
AUX	Auxiliary
Baseband	The total signal before it is modified for transmission or otherwise manipulated.
Baud (Bd)	A measure of signaling rate based on the number of signaling events per unit of time.
Beamwidth	The included angle between two rays (usually the half-power points) on the radiation pattern, which includes the maximum lobe, of an antenna.

Optoelectronic Glossary, Continued

BER	Bit error rate
BERT	Bit error rate test
BIG	Broadband Integrated Gateway
BIOS	Basic Input/Output System
BIST	Built-in self-test
Bit	Short for Binary Digit. Can be either a "one" or a "zero."
Blanking level	The amplitude of the front and back porches of the composite video signal.
BNC	A coaxial connector that uses a bayonet type attachment to secure the cable. It is also known as Baby N connector.
BPF	Bandpass filter
Bps	Bits per second - The total number of bits sent in a second of time.
BPSK	Binary Phase Shift Keying
BW	Bandwidth
Byte	A group of bits treated as a unit
CF	Continuous feed
Circuit switching	The type of signal switching traditionally used by telephone companies to create a physical connection between a caller and a called party.
CIRD	Commercial Integrated Receiver Decoder
CIM	Communications Interface Module
CISC	Complex Instruction Set Computer. A computer that uses many different types of instructions to conduct its operations, i.e., IBM PCs, Apple Macintosh's, IBM 370 mainframes.
CIU	Customer Interface Unit
C/N or CNR	Carrier-to-noise ratio

Optoelectronic Glossary, Continued

Compression	The non-linear change of gain at one level of a signal with respect to the change of gain at another level for the same signal. Also, the elimination of redundant information from an audio, data, or video signal to reduce transmission requirements.
CSO	Composite Second Order
CTB	Composite Triple Beat
C/T	Carrier-to-noise temperature ratio
CW	Continuous Wave
dB	Decibel
dBc	Decibels relative to a reference carrier
DBDS	Digital Broadband Delivery System
dBm	Decibels relative to 1 milliwatt
dB_i	Decibels of gain relative to an isotropic radiator
dBuV	Decibels relative to 1 microvolt
dBW	Decibels relative to 1 watt
dBmV	Decibels relative to 1 millivolt
DC	Direct current
DC	Directional coupler
DES	Data Encryption Standard
Deviation	The peak difference between the instantaneous frequency of the modulated wave and the carrier frequency, in an FM system.
DFB	Distributed feed back laser
Differential gain	The difference in amplification of a signal (superimposed on a carrier) between two different levels of carrier.
Diplex filter	A filter which divides the frequency spectrum into a high frequency segment and a low frequency segment so that two different signals can be sent down the same transmission path.

Optoelectronic Glossary, Continued

Distribution System	Part of a cable system consisting of trunk and feeder cables used to carry signals from headend to subscriber terminals.
Downconverter	A device that converts an input signal to a lower frequency output signal.
Down link	A transmission path carrying information from a satellite or spacecraft to earth.
DP	Data processing
DPU	Digital processing unit
DSP	Digital signal processor
DSR	Digital Storage and Retrieval System
D to U	Desired to undesired signal ratio
DTMF	Dual Tone Multiple Frequency
Duplexer	A device which permits the connection of both a receiver and a transmitter to a common antenna.
DVM	Digital voltmeter
DWDM	Dense Wave Division Multiplexing
ECL	Emitter coupled logic
ECM	Entitlement Control Message
EDFA	Erbium Doped Fiber Amplifier
EPROM	Erasable Programmable Read-Only Memory
EEPROM	Electrically Erasable Programmable Read-Only Memory
EIA	Electronics Industry Association
EMI	Electromagnetic interference
Emission designer	An FCC or CCIR code that defines the format of radiation from a transmitter.
EQ	Equalizer

Optoelectronic Glossary, Continued

Equalization	The process of compensating for an undesired result. For example, equalizing tilt in a distribution system.
ERP	Effective radiated power
FAOC	Frequency agile output converters
FET	Field-effect transistor
FIFO	First in, first out
FM	Frequency modulation
Forward path	Signal direction from the headend to the set-top terminal.
FP	Fabry-Perot laser
FPGA	Field Programmable Gate Array. A flexible logic device with thousands of gates
Fiber	A single strand of glass used as an optical transmission medium; or a bundle of glass strands in a CATV system.
Frequency	The number of similar shapes in a unit of time. For example, the number of sine waves moving past a fixed point in a second.
Frequency Agile	The ability to change from one frequency to another without changing components.
Frequency Modulation	A system of modulation where the instantaneous radio frequency of the carrier varies in proportion to the instantaneous amplitude of the modulating signal while the amplitude of the radio frequency carrier is independent of the amplitude of the modulating signal.
Frequency Response	The effect that changing the frequency has on the magnitude of a signal.
Frequency Stability	A measure of the departure from nominal frequency value of a signal, with respect to time, temperature, or other influence.
FSM	Field strength meter
FSK	Frequency-shift keying

Optoelectronic Glossary, Continued

ft-lb	Foot-pound. A unit of work equal to lifting one pound of weight, one foot in distance.
FTP	File Transfer Protocol
Gain	An increase in signal relative to a reference
Gbps	Gigabits per second
Headend	Location and equipment that receives data from a satellite (or other) source and reformats that data for input to a broadband distribution network.
HEDA	Headend Driver Amplifier
HGD	High Gain Dual
Hertz	A unit of frequency equal to one cycle per second.
Hetrodyne	Changing the frequency of a signal by mixing it with another signal to get the sum and difference of the two.
I/O	Input/output
IC	Integrated circuit
ICIM	Intelligent Communications Interface Module
ICP	Internal Control Program. A series of policies to protect company sensitive and export controlled information.
IDR	Intermediate Data Rate
IEC	International Electro-technical Commission
IF	Intermediate frequency
IFL	Interfacility link
IP	Internet protocol
ITU	International Telecommunications Union
Kbps	Kilobits per second
in-lb	Inch-pound
LCD	Liquid crystal display

Optoelectronic Glossary, Continued

LCI	Local craft interface
LED	Light-emitting diode
LIFO	Last-in, first-out
LNA	Low-noise amplifier
LNB	Low-noise block converter
LNC	Low-noise converter
Mbps	Megabits per second
MCU	Master Control Unit
Multipath (multipath transmission)	The phenomenon which results from a signal traveling from point to point by more than one path so that several copies of the signal arrive at the destination at different times or at different angles.
mux	multiplexed
Nanosecond	1 thousandth of a microsecond
Nm	Newton meter
NIU	Network Interface Unit
Node	A branching or exchange point.
OEM	Original equipment manufacturer
OOB	Out of band
OIM	Optical interface module
OSM	Optical-Sub module
PCB	Printed circuit board
PCM	Pulse code modulation
PDI	Pressure differential indicator
PDU	Power distribution unit
PIN	PIN Photodiode - A standard photodiode. (PIN stands for Positive doped - Intrinsic region - Negative doped and has to do with the chip architecture)

Optoelectronic Glossary, Continued

PLL	Phase Lock Loop. An electronic servo system controlling an oscillator to maintain a constant phase angle relative to a reference signal.
PROM	Programmable Read Only Memory
PWB	Printed wiring board
QAM	Quadrature Amplitude Modulation
QPR	Quadrature Partial Response
QPSK	Quadrature Phase-Shift Keying
RC	Reverse conditioner
Redundant	A secondary or backup (electronic) system
Reverse path	Signal flow direction toward the headend.
RF	Radio frequency
RF Bypass	A bypass feature that allows subscribers to view a clear analog channel while recording a digital or analog channel on a VCR.
RFI	Radio frequency interference
RMA	Return material authorization
RMS	Root Mean Square
Router	A data communications device which examines a packet and routes the packet to an output port appropriate to the packet destination.
RS	Remote Sensing
RX	Receive or receiver
SAM	Signal analysis meter
SAT	Site acceptance test
S-band	The group of frequencies between 2 and 4 GHz.
SET	Secure electronic transaction

Optoelectronic Glossary, Continued

Scattering	Random directional change of a wave or part of a wave caused by an irregular reflecting surface or by passing through an inhomogeneous transmission medium.
SLM	Signal level meter
SM	Status monitor
SMC	Status monitoring and control
SMIU	Status Monitor Interface Unit
SMU	Server Management Unit
S/N or SNR	Signal-to-noise ratio
SNMP	Simple Network Management Protocol
SONET	Synchronous optical network
SP	Splitter. It is a device that divides power from an input to deliver multiple outputs or combines multiple input into one output.
Spread Spectrum	A modulation technique to spread a narrow band signal over a wide band of frequencies.
Spurious	Anything other than the desired result
SSPA	Solid-state power amplifier
Sweep generator	A signal source which can automatically vary its frequency continuously from one frequency to another.
Synchronous transmission	A method of sending information over a path and separating discrete characters and symbols by a precise separation in time.
TEC	Thermo-electric cooler
TCP/IP	Transmission control protocol/internet protocol
TDM	Time division multiplexing
TNCS	Transmission Network Control System
Torque	Twisting force applied to a device.
TS	Transport Stream

Optoelectronic Glossary, Continued

TTCN	True tilt correction network
Tx	Transmit or transmitter
UBT	Unbalanced triple
UPS	Un-interruptible power supply
Upstream	Signal transmission toward the headend
UTP	Unshielded twisted pair
uV	One millionth of a volt (microvolt)
V	Volt
V AC	Volts alternating current
VBR	Variable bit rate
VCA	Voltage controlled attenuator
V DC	Volts direct current
VOD	Video-on-demand
VOM	Volt ohm meter
W	Watts
WDM	Wave Division Multiplexing
YEDFA	Ytterbium/erbium doped fiber amplifier

Index

- A**
- alarms
 - checking using ICIM, 3-26
 - checking using LCI, 5-6
 - thresholds, 3-27
- B**
- block diagram, 1-4
- C**
- chassis
 - illustration, 2-5
- compliance
 - electromagnetic compatability, viii
 - laser & electrical, viii
- configuration
 - saving using ICIM, 3-33
- configuration options, 1-11
- connections
 - optical cables, 2-11
 - RF cable, 2-6
- connectors
 - cleaning optical, 5-13
- F**
- Fiber Fish tool, 2-9
- I**
- ICIM
 - block diagram, 3-2
 - front panel, 3-3
 - front panel features, 3-4
 - front panel illustration, 3-3
 - function, 3-2
 - key pad, 3-5
 - LCD, 3-4
 - operating, 3-12
 - password, 3-6, 3-8
- indicator
 - alarm, 1-5
 - power on, 1-5
- installations
 - processor, 2-7, 3-2
 - sub-module, 2-12
- L**
- LCI
 - connecting to chassis, 4-10
 - software installation, 4-6
 - starting software, 4-11
- M**
- manufacturing data
 - checking, 3-31
 - display, 3-30
- menu
 - ALARM using ICIM, 3-28
 - CONFIG using ICIM, 3-22
 - ICIM, 3-13
 - ICIM menu structure, 3-14
 - MAIN using ICIM, 3-12
 - software menu structure, 3-15
- Module Maintenance, 5-2
- N**
- noise suppression, 1-12
- O**
- operating environment, 2-3
- optical
 - connectors, 5-13
- P**
- parameters
 - configuring, 3-20
- parameters
 - configuring with ICIM, 3-21
 - monitored, 3-16
- password
 - changing using ICIM, 3-10
 - disabling using ICIM, 3-11
 - expired in ICIM, 3-7
 - function with ICIM, 3-7
 - ICIM, 3-6

Index, Continued

re-entering using ICIM, 3-9
rejected by ICIM, 3-9
using for the first time, 3-8

R

receive processor
 block diagram, 1-4
Redundancy Interface Panel
 features, 2-15
 installation and connections, 2-16
 introduction, 2-14
 master/slave connections, 2-18
redundant mode, 1-11

S

safety
 laser, ix, x
 precautions, vi, vii, viii
website, 4-5
status
 checking using ICIM, 3-18

T

transmit processor
 back panel, 1-9
 configuration overview, 1-10
 configuration summary, 1-10
 features, 1-2
 operation, 1-3
transmitter sub-module
 features, 1-6
 front panel, 1-6
 identification, 1-8
troubleshooting
 alarm conditions, 5-4
 general, 5-3

W

warning
 labels, x
 radiation, ix
warranty, xi



Cisco Systems, Inc.
5030 Sugarloaf Parkway, Box 465447
Lawrenceville, GA 30042

678 277-1120
800 722-2009
www.cisco.com

This document includes various trademarks of Cisco Systems, Inc. Please see the Notices section of this document for a list of the Cisco Systems, Inc. trademarks used in this document.

Product and service availability are subject to change without notice.

© 2001, 2008, 2012 Cisco and/or its affiliates.

All rights reserved.

December 2012 Printed in USA

Part Number 78-751337-01 Rev C