



Prisma II bdr 4:1 Redundant Receive Processor

Installation and Operation Guide







For Your Safety

Explanation of Warning and Caution Icons



Avoid personal injury and product damage! Do not proceed beyond any symbol until you fully understand the indicated conditions.

The following warning and caution icons alert you to important information about the safe operation of this product:

-  **You may find this symbol in the document that accompanies this product. This symbol indicates important operating or maintenance instructions.**
-  **You may find this symbol affixed to the product. This symbol indicates a live terminal where a dangerous voltage may be present; the tip of the flash points to the terminal device.**
-  **You may find this symbol affixed to the product. This symbol indicates a protective ground terminal.**
-  **You may find this symbol affixed to the product. This symbol indicates a chassis terminal (normally used for equipotential bonding).**
-  **You may find this symbol affixed to the product. This symbol warns of a potentially hot surface.**
-  **You may find this symbol affixed to the product and in this document. This symbol indicates an infrared laser that transmits intensity-modulated light and emits invisible laser radiation or an LED that transmits intensity-modulated light.**

Important

Please read this entire guide. If this guide provides installation or operation instructions, give particular attention to all safety statements included in this guide.

Notices

Trademark Acknowledgments

Cisco and the Cisco logo are trademarks or registered trademarks of Cisco and/or its affiliates in the U.S. and other countries. To view a list of cisco trademarks, go to this URL: www.cisco.com/go/trademarks.

Third party trademarks mentioned are the property of their respective owners.

The use of the word partner does not imply a partnership relationship between Cisco and any other company. (1110R)

Publication Disclaimer

Cisco Systems, Inc. assumes no responsibility for errors or omissions that may appear in this publication. We reserve the right to change this publication at any time without notice. This document is not to be construed as conferring by implication, estoppel, or otherwise any license or right under any copyright or patent, whether or not the use of any information in this document employs an invention claimed in any existing or later issued patent.

Copyright

© 2008, 2012 Cisco and/or its affiliates. All rights reserved. Printed in the United States of America.

Information in this publication is subject to change without notice. No part of this publication may be reproduced or transmitted in any form, by photocopy, microfilm, xerography, or any other means, or incorporated into any information retrieval system, electronic or mechanical, for any purpose, without the express permission of Cisco Systems, Inc.

Contents

Safety Precautions.....	v
Compliance.....	vii
Laser Safety.....	viii
Chapter 1	Introduction
Overview.....	1-1
Introduction to the Prisma II bdr 4:1 Redundant Receive Processor	1-2
The Front Panel of the Prisma II bdr 4:1 Redundant Receive Processor.....	1-5
The Front Panel of the Optical Receiver	1-6
The Back Panel of the Receive Processor.....	1-7
Configuration Summary	1-8
Configuration Options	1-9
Chapter 2	Installation
Overview.....	2-1
Before You Begin.....	2-2
Site Requirements	2-3
Preparing for Installation.....	2-4
Connecting the RF Cables to the Chassis	2-6
Installing the 4:1 Receive Processor in the Chassis	2-7
Connecting Optical Cables	2-9
Installing Optical Receivers in the Processor.....	2-12
Prisma II Redundancy Interface Panel	2-14
Prisma II Redundancy Interface Panel Features	2-15
Interface Panel Installation and Connections	2-16
Master/Slave Connections	2-18
Chapter 3	Operation Using the ICIM
Overview.....	3-1
ICIM Introduction.....	3-2
The ICIM Front Panel.....	3-3
The ICIM Password.....	3-6
Operating the ICIM	3-12
Monitoring Operating Status Using the ICIM.....	3-16
Configuring the bdr 4:1 Receive Processor Using the ICIM.....	3-20
Checking bdr 4:1 Receive Processor Alarms Using the ICIM	3-24
Checking Manufacturing Data Using the ICIM	3-29
Using the ICIM to Save the Configuration.....	3-32

Contents, Continued

Chapter 4	Operation Using the LCI Software	
	LCI Introduction	4-3
	System Requirements.....	4-4
	Obtaining and Installing the Prisma II Driver Upgrade	4-5
	Installing LCI.....	4-6
	Connecting your Computer to the Chassis	4-10
	Starting LCI.....	4-11
	LCI Device Tree Overview	4-13
	Accessing the Device Details Window	4-14
	Checking the Operating Status	4-17
	Configuring the bdr Receive Processor	4-19
	Checking bdr Receive Processor Alarms.....	4-22
	Checking Device Properties	4-24
Chapter 5	Maintenance and Troubleshooting	
	Overview.....	5-1
	Module Maintenance.....	5-2
	General Troubleshooting Information.....	5-3
	Troubleshooting Alarm Conditions	5-4
	Troubleshooting LCI	5-6
	Cleaning Fiber-Optic Connectors	5-12
Chapter 6	Customer Information	
	Optoelectronic Glossary	Glossary -1
	Index	Index -1

Safety Precautions

Protect Yourself From Electric Shock and Your System From Damage!

- This product complies with international safety and design standards. Observe all safety procedures that appear throughout this guide, and the safety symbols that are affixed to this product.
- If circumstances impair the safe operation of this product, stop operation and secure this product against further operation.

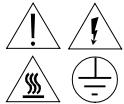

Avoid personal injury and product damage! Do not proceed beyond any symbol until you fully understand the indicated conditions!



You will find this symbol in the literature that accompanies this product. This symbol indicates important operating or maintenance instructions.



You may find this symbol affixed to this product. This symbol indicates a live terminal; the flash points to the terminal device.



You may find this symbol affixed to this product. This symbol indicates a protective earth terminal.



You may find this symbol affixed to this product. This symbol indicates excessive or dangerous heat.

Safety Precautions, Continued

Factory Service

Refer service only to service personnel who are authorized by the factory.

Enclosure

- Do not allow moisture to enter this product.
- Do not open the enclosure of this product unless otherwise specified.
- Do not push objects through openings in the enclosure of this product.

Cables

- Always pull on the plug or the connector to disconnect a cable. Never pull on the cable itself.
- Do not walk on or place stress on cables or plugs.

Compliance

Laser and Electrical Safety

UL 1419:1997: A sample of this equipment has been tested and found to meet the requirements of UL 1419:1997.

CSA C22.2 No. 1:1994: A sample of this equipment has been tested and found to meet the requirements of CSA C22.2 No. 1:1994.

Electromagnetic Compatibility

FCC Part 15 Subpart B: This equipment has been tested and found to comply with the limits for a Class A digital device according to Part 15 of FCC Rules. These limits are designed to provide reasonable protection against harmful interference when the equipment is operated in a commercial environment.

This equipment generates, uses, and can radiate radio frequency energy and, if not installed and used in accordance with the instruction manual, may cause harmful interference to radio communications. Operation of this equipment in a residential area is likely to cause harmful interference in which case the user will be required to correct the interference at his own expense.

Industry Canada ICES-003: This Class A digital apparatus meets all the requirements of the Canadian Interference-Causing Equipment Regulations.

Industrie Canadienne ICES-003: Cet appareil numérique de la class A respecte toutes les exigences du Règlement sur le matériel brouilleur du Canada.

Laser Safety

Introduction

This product receives intensity-modulated light and may emit invisible radiation.

Warning: Radiation

 **WARNING:**
Avoid personal injury! Use of controls, adjustments, or procedures other than those specified herein may result in hazardous radiation exposure.

- Do not apply power to this product if the fiber is unmated or unterminated.
- Do not stare into an unmated fiber or at any mirror-like surface that could reflect light that is emitted from an unterminated fiber.
- Do not view an activated fiber with optical instruments.

Warning: Fiber Chips

 **WARNING:**
Avoid personal injury! Wear safety glasses and use extreme caution when you handle the glass chips that are inside the cladding of the optical fiber. X-ray cannot detect these glass chips if they become embedded in the skin. Place the chips immediately in a small waste container and discard.

Modifications

Do not make modifications to this product without the approval of Cisco.

Whenever modifications that may affect hazard levels are made to the optical fiber communication system, the person or organization that performs such modification must reassess hazard levels. They must do this by conducting tests and measurements wherever appropriate for the ensurance of compliance. If there is a change in the hazard level, they must re-label this product.

Laser Safety, Continued

Laser Warning Labels

The Prisma II™ bdr™ Optical Receiver sub-modules bears the following labels. .



Chapter 1

Introduction

Overview

Introduction

This chapter introduces the front and back panels of the Prisma II™ bdr™ 4:1 Redundant Receive Processor, the Prisma II bdr Optical Receiver and presents a configuration overview.

Qualified Personnel

Only appropriately qualified and trained personnel should attempt to install this product.



WARNING:

Allow only qualified personnel to install, operate, maintain, and service this product. Otherwise, personal injury or equipment damage may occur.

In This Chapter

This chapter contains the following topics.

Topic	See Page
Introduction to the Prisma II bdr 4:1 Redundant Receive Processor	1-2
The Front Panel of the Prisma II bdr 4:1 Redundant Receive Processor	1-5
The Front Panel of the Optical Receiver	1-6
The Back Panel of the Receive Processor	1-7
Configuration Summary	1-8
Configuration Options	1-9

Introduction to the Prisma II bdr 4:1 Redundant Receive Processor

bdr 4:1 Redundant Receive Processor Overview

The Prisma II optical network is an advanced transmission system designed to optimize network architectures and increase reliability, scalability, and cost effectiveness. The Prisma II bdr 4:1 Redundant Receive Processor is designed to operate over a wide range of optical input powers and loss budgets. Microprocessor control allows ease of installation and flexibility of application. The Prisma II bdr 4:1 Redundant Receive Processor houses two Prisma II bdr Optical Receivers.

For the purpose of this guide, the Prisma II bdr 4:1 Redundant Receive Processor is often referred to as “the processor”. The Prisma II bdr Optical Receivers are referred to as the “optical receiver” or “receiver”.

bdr Receive Processor Features

The Prisma II bdr 4:1 Redundant Receive Processor has the following features.

- Front panel green LED to indicate operating status
- Front panel red LED to indicate alarm status
- -20 dB test point
- Test point selector
- Optical receiver insertion slots (2)
- Plug-and-play capability
- Compatible with Cisco LCI software and TNCS software
- Blind mate RF connections

Introduction to the Prisma II bdr 4:1 Redundant Receive Processor, Continued

Prisma II bdr Digital Reverse 4:1 Multiplexing System

The Prisma II platform supports Cisco's Baseband Digital Reverse technology. The Prisma II bdr Digital Reverse 4:1 Multiplexing System includes a unique approach for incorporating network redundancy. At the transmit end of the system, typically in a hub or remote terminal, four 7 to 42 MHz (or user selectable 5-40 MHz and 10-45 MHz) analog reverse path signals are input to a transmit processor. The transmit processor converts each signal to a baseband digital data stream and time division multiplexes the four streams into a single data stream. The data stream is duplicated to enable routing for redundant optical transport.

One (non-redundant application) or two (redundant application) bdr transmitters installed within the transmit processor, convert the baseband data stream to an optical signal for transmission at either 1310 nm or 1550 nm ITU grid wavelengths. ITU grid wavelengths are used for Dense Wave Division Multiplexing (DWDM) applications.

On the receive end, typically in a large hub or headend, one or two Prisma II bdr Optical Receivers located in the Prisma II Receive Processor receive the optical signal and perform conversion back to the baseband data stream. The Prisma II bdr Receive Processor de-multiplexes the data stream and converts the four resultant data streams back to four analog RF signals.

The Prisma II bdr Receive Processor can be controlled by an ICIM, the LCI software, or TNCS software. The Prisma II bdr Receive Processor will only operate with a Prisma II bdr Transmit Processor or the Model 6940/6944 bdr 4:1 Enhanced Node Digital Module. It is not compatible with previous Prisma bdr products.

Optical Input

Optical input connectors for the Prisma II Optical Receiver are SC/APC.



WARNING:

Avoid damage to your eyes! Do not look into any optical connector while the system is active. Even if the unit is off, there may still be hazardous optical levels present.

Introduction to the Prisma II bdr 4:1 Redundant Receive Processor, Continued

Prisma II bdr Digital Reverse 4:1 Multiplexing System

A block diagram of the Prisma II bdr Digital Reverse 4:1 Multiplexing System is shown below.

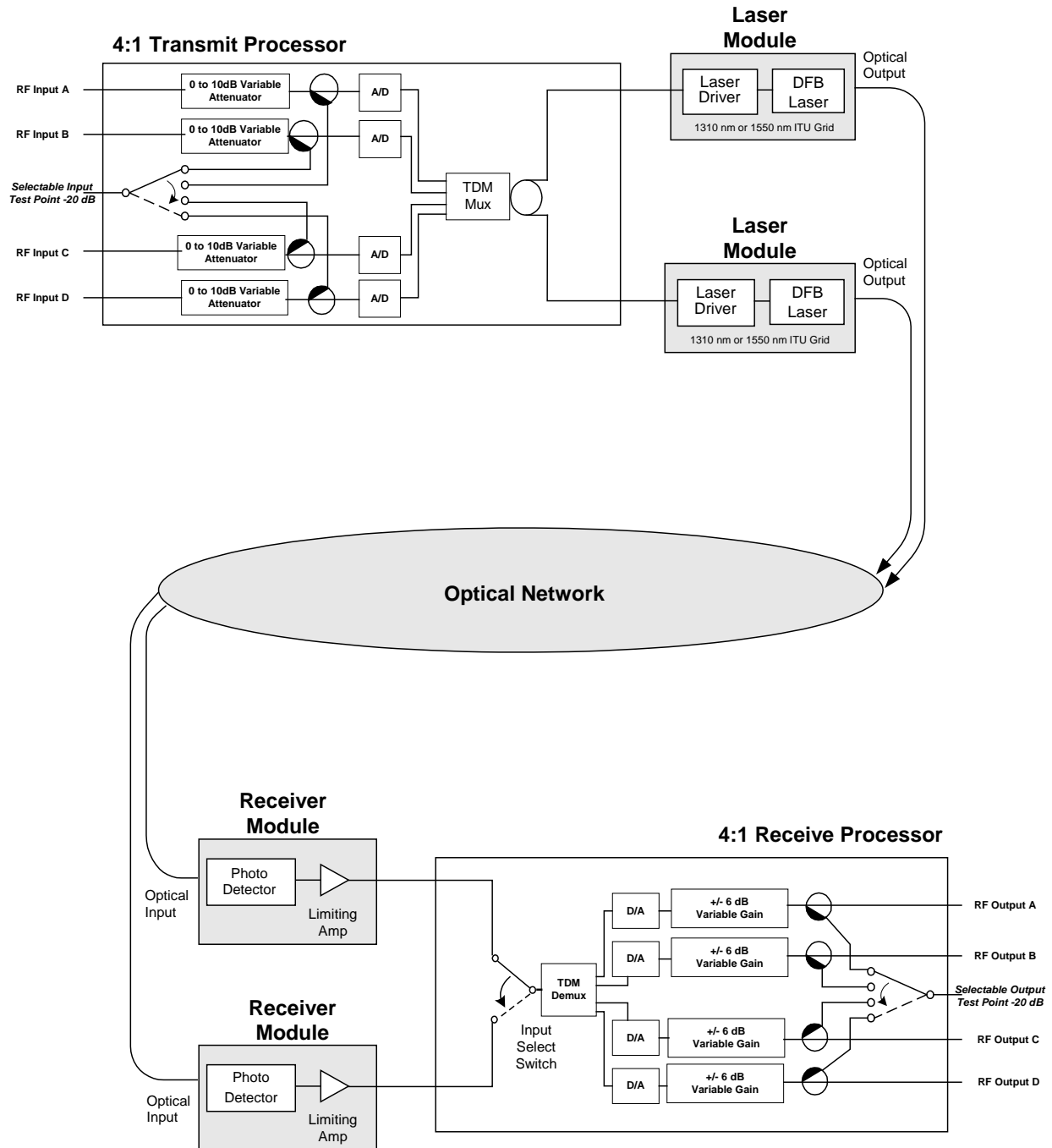

The Front Panel of the Prisma II bdr 4:1 Redundant Receive Processor

Illustration

The front panel of the Prisma II bdr 4:1 Redundant Receive Processor is shown below.

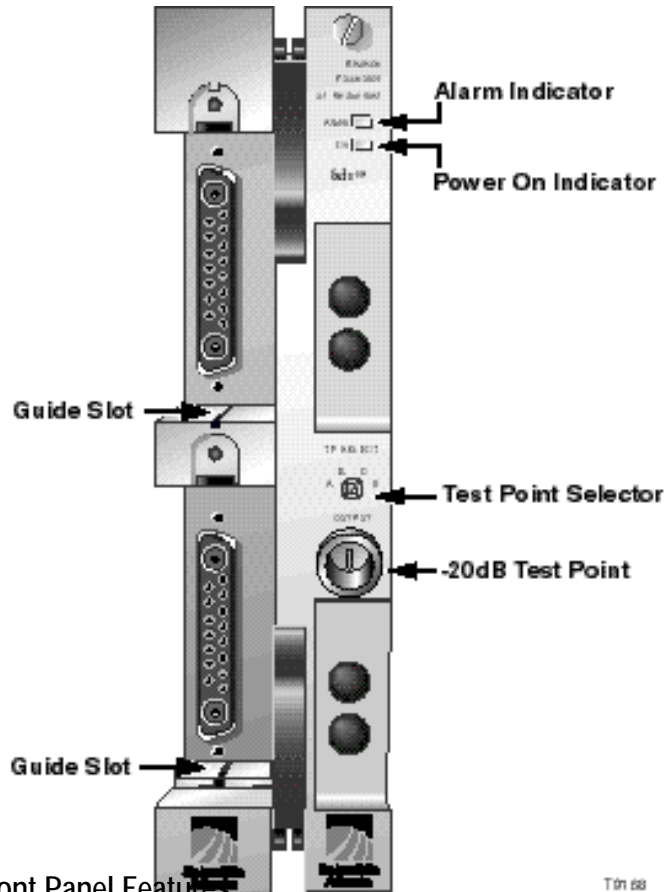

Receive Processor Front Panel Features

The features of the front of the Prisma II bdr 4:1 Redundant Receive Processor are shown below.

Part	Function
Alarm Indicator	Illuminates or blinks when an alarm condition occurs
Power On Indicator	Illuminates when power is supplied to the module
Test point selector	Selects which RF output the -20 dB test point represents
-20 dB Test Point	Provides a -20 dB sample of the selected RF output signal
Guide slots	Guide the Prisma II bdr Optical Receiver into the processor

The Front Panel of the Optical Receiver

Illustration

The front panel of the Prisma II bdr Optical Receiver is shown below.

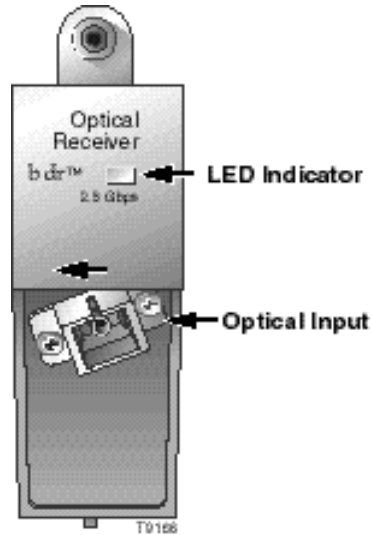

Optical Receiver Front Panel Features

The features of the front of the Prisma II bdr Optical Receiver are shown below.

Part	Function
Bi-color LED Indicator	Illuminates red when an alarm condition occurs, illuminates green when operation is normal.
Optical Input	Connects the optical input fiber to the optical receiver.

The Back Panel of the Receive Processor

Back Panel Connectors

Blind-mate connectors make it easy to install the Prisma II bdr 4:1 Redundant Receive Processor in the Prisma II Chassis. The chassis provides:

- RF signal output connection
- Electrical power input connection
- Alarm communications connection
- Status-monitoring communications
- Communications and control connections

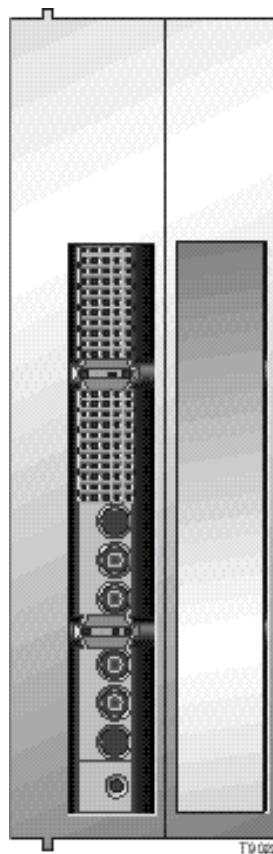

Power and Communications Connector

The power and communications connector on the back of the module mates with a connector inside of the chassis, and supplies power from the chassis to the processor. The 110-pin connector also routes alarm and status-monitoring information from the processor to the Prisma II Chassis.

Configuration Summary

Overview

The Prisma II bdr 4:1 Redundant Receive Processor is shipped from the factory with operational parameters set to factory defaults. However, you may choose to configure the operating parameters so that they are best suited for your application.

Configuration and Monitoring Methods

The Prisma II bdr 4:1 Redundant Receive Processor may be controlled using one of three different methods.

- The Prisma II Intelligent Communications Interface Module (ICIM)

If an ICIM is installed in the Prisma II Chassis, it may be used to configure and monitor Prisma II application modules within its domain. For instructions on operating this module using the ICIM, refer to Chapter 3, **Operation Using the ICIM**.

- The Local Craft Interface (LCI) software

The Local Craft Interface (LCI) software running on a locally connected PC may be used to configure operating parameters of Prisma II modules. For instructions on operating this module using the LCI software, refer to Chapter 4, **Operation Using the LCI Software**.

- Cisco's Transmission Network Control System (TNCS) software

If the ICIM is installed, TNCS software may be used to configure and monitor all functions of the Prisma II modules. For instructions on operating this module using TNCS, see the manual that was shipped with the TNCS software, *TNCS Administrator Software User's Guide*, part number 730201.

Parameter Configuration Summary

Using any of the above methods, you can configure the following parameters.

- The receiver bandwidth
- Redundancy options
- Enable default or forced receiver switching
- Muting options of each RF output
- Attenuation of each RF output

Configuration Options

Restoring the Factory Default Configuration

After initialization, you may restore the processor's factory default configuration at any time. However, in order to implement the restore function, you must use an ICIM. The **Restore Factory Defaults** command is an item in the processor's MFG. DATA menu. For details about the ICIM, the MFG. DATA menu, and the required User password, refer to Chapter 3, **Operation Using the ICIM**.

Frequency Band Selection

The Prisma II bdr 4:1 Redundant Receive Processor may be configured to operate in one of three different frequency bands.

- 5–40 MHz
- 7–42 MHz (default setting)
- 10–45 MHz

Important: The receive processor must be configured to match the frequency band selection of the transmit processor in order to operate properly.

Redundant Mode

The Prisma II bdr 4:1 Redundant Receive Processor may be configured to operate in one of three different redundancy modes.

- **Internal Redundancy (Yes)** - The processor can be configured to operate with internal redundancy where a redundant optical receiver is located in the same processor as the primary optical receiver, and is activated only if the primary receiver has failed. **Internal Redundancy** set to **Yes** is the default setting.
- **Internal Redundancy (No)** - The processor can be configured to operate without redundancy. The primary receiver operates without backup and does not generate any alarms as long as it is installed and operating.
- **External Redundancy** - The processor can be configured for external redundancy where it acts as a redundant receive processor to a primary receive processor until an external signal indicates the primary processor has failed. The default setting for **External Redundancy** is **No**.

Switch Function

The processor's Switch function can be configured to **Deflt_1** or **Deflt_2**. This determines how the channels are switched. **Deflt_1** and **Deflt_2** selects the default optical receiver. Additionally, the Switch function can be configured to **Force_1** or **Force_2**. This function forces a switch to either optical receiver 1 or optical receiver 2, regardless of any errors. **Deflt_1** is the default setting.

Configuration Options, Continued

RF Output

The processor can be configured to mute the **RF Output** of individual channels A, B, C, or D automatically or manually. When in Redundant mode, if configured to **Auto**, the processor determines whether the RF output should be muted. Muting is implemented based on alarms such as missing receiver or loss of signal. The processor can also be configured to mute RF output of individual channels manually as follows: If **RF Output** is configured to **On**, the channel's RF output is not muted; and if configured to **Off**, the channel's RF output is muted. **Auto** is the default setting.

Attenuation

The amount of attenuation for each of the four RF output channels of the processor can be individually configured. Using the ICIM, the RF output of channels A, B, C, and D can be individually attenuated over a range of (-6 dB to +6 dB in 0.5 dB steps. Using the LCI or TNCS software, RF outputs can be individually attenuated over the same range (-6 dB to +6 dB), but in 0.1 dB steps. **0 dB** is the default setting.

Frame Error Counting

The processor calculates the actual frame error rate (FER) for the *last* second, and the *average* frame error rate for the last minute, hour, and day since the last reset (FERrst). These numbers can be monitored in the STATUS menus.

Using the CONFIG menu, the frame error rate counter can be configured to **Count**, so that the processor continuously counts all frame errors since last reset, or configured to **Reset**, so that the processor resets the frame error count to zero and begins a new count. **Reset** only resets the frame error rate counter and not the second, minute, hour, or day counters. **Count** is the default setting.

Important: After using the **Reset** function, the frame error rate counter must be returned to the **Count** configuration in order to re-start the frame error rate count. If left in **Reset**, the counter will be continuously resetting and will not display a frame error rate.

Alarms

While this module contains no user-configurable alarm thresholds, some alarms may occur as a result of user-configurable settings or user action. For example, muting of all outputs generates an alarm. An alarm is also generated when, in redundant mode, one of the optical receivers is removed. Another example of user action that could generate an alarm would be disconnection of optical input cables. Alarm conditions for specific parameters are labeled as Major, Minor, or Fault. Major and Minor alarms also designate if the parameter in alarm is of too high a value (MajorH) or too low a value (MajorL). Major alarms generated by the processor produce a constant, illuminated red LED on the processor front panel. Minor alarms generate a blinking red LED.

Configuration Options, Continued

Test Point Selector

The processor front panel houses a -20 dB Test Point and a Test Point Selector switch. The Test Point Selector switch configures which RF output (A, B, C, or D) the -20 dB Test Point represents. The Test Point provides a -20 dB sample of the selected RF output signal.

-20 dB Test Point

The -20 dB Test Point provides a -20 dB sample of the RF output signal. The RF output channel that is measured is determined by using the Test Point Selector switch.

Additional Information

For additional information on configuring the Prisma II bdr 4:1 Redundant Receive Processor, including ICIM menus and LCI software screens, see Chapter 3, **Operation Using the ICIM**, or Chapter 4, **Operation Using the LCI Software**.

For specific information on processor alarms see either **Checking bdr Receive Processor Alarms Using the ICIM**, in Chapter 3, or **Checking bdr Receive Processor Alarms** in Chapter 4.

Chapter 2 Installation

Overview

Introduction

This chapter contains instructions, site requirements, equipment, and tools needed to install the Prisma II bdr 4:1 Redundant Receive Processor and the Prisma II bdr Optical Receivers.

Qualified Personnel

 **WARNING:**
Allow only qualified personnel to install, operate, maintain, or service this product. Otherwise, personal injury or equipment damage may occur.

In This Chapter

This chapter contains the following topics.

Topic	See Page
Before You Begin	2-4
Site Requirements	2-3
Preparing for Installation	2-4
Connecting the RF Cables to the Chassis	2-6
Installing the 4:1 Receive Processor in the Chassis	2-7
Connecting Optical Cables	2-9
Installing Optical Receivers in the Processor	2-12
Prisma II Redundancy Interface Panel	2-14
Prisma II Redundancy Interface Panel Features	2-15
Interface Panel Installation and Connections	2-16
Master/Slave Connections	2-18

Before You Begin

Overview

Before you begin, make sure that all modules are in good condition and that you have the tools and equipment listed here.

Unpacking and Inspecting the Module

As you unpack the module, inspect it for shipping damage. If you find any damage, contact Cisco Services.

Equipment and Tools Needed

You need the following equipment and tools to install this product.

You need . . .	To . . .
a Prisma II Chassis equipped with 56 RF connectors and at least one Prisma II power supply	provide housing, power and input/output connections to the module.
3/8-in. flat-blade screwdriver	secure the module in the chassis.
two optical cables with SC/APC connectors	carry optical input signals.
four 75 ohm RF cables with F-type connectors	carry RF output signals.
a 7/16-in. open-end wrench	secure RF cables to the connectors on the chassis.

Site Requirements

Overview

Before you begin, make certain that your installation site meets the requirements discussed in this section.

Access Requirements

Ensure that only authorized personnel have access to this equipment. Otherwise, personal injury or equipment damage may occur.



WARNING:

Use this product in locations that restrict access to all persons who are not authorized. Otherwise, personal injury or equipment damage may occur.

Equipment Rack

To install this module, your site must be equipped with an Electronics Industry Association (EIA) equipment rack that properly houses the Prisma II Chassis with proper spacing for air circulation. For instructions on installing the chassis in the rack, refer to the *Prisma II Chassis Installation and Operation Guide*, part number 713375.

Operating Environment



CAUTION:

Avoid damage to this product! Operating this product above the maximum operating temperature specified voids the warranty.

Follow these recommendations to maintain an acceptable operating temperature.

- Temperature inside the rack must be between -10°C and 65°C (14°F and 149°F).
- Keep cooling vents clear and free of obstructions.
- Provide a non-condensing environment
- Provide ventilation, as needed, using one or more of the following methods.
 - air-deflecting baffles
 - forced-air ventilation
 - air outlets above enclosures

Preparing for Installation

Overview

Before installing the module, review the Prisma II Chassis electrical power, slot availability restrictions, and illustrations discussed in this section.

Electrical Power

The Prisma II modules receive electrical power from the Prisma II Chassis via the Prisma II power supplies. For specific information concerning chassis power requirements and power supply installation, see the guide that was shipped with the chassis, the *Prisma II Chassis Installation and Operation Guide*, part number 713375.

Chassis Slot Availability

The Prisma II bdr 4:1 Receive Processor is a double-wide module. It may only be installed in slots 5 through 16. Slots 15 and 16 are usually reserved for the Intelligent Communications Interface Module (ICIM), if installed. However, if an ICIM is not installed in slots 15 and 16, this processor or any other module(s) could be installed in those slots.

Power Supply Installation Slot Restrictions (Slots 1 through 4)

Important: Slots 1 through 4 of the Prisma II Chassis are reserved exclusively for the Prisma II primary and redundant power supplies. If a redundant power supply is not installed, and slots 5-16 contain 4:1 Transmit Processors or 4:1 Receive Processors, then no other module can be installed in the redundant power supply slots.

If only one power supply is installed, a Prisma II Power Supply Blank, part number 716308 must be installed in the unused power supply slots.

Front and Rear Access Chassis Styles

The Prisma II Chassis has power inlets, RF input and output ports, and other connectors which are located on the connector interface panel. This panel may be located on the front (front access) or rear (rear access) of the chassis depending on the system you have purchased. Regardless of their location, these connections are labeled the same, serve the same function, and are made in the same manner whether located on the front or the rear of the chassis.

Detailed illustrations of both the front and rear access chassis are located on the next page of this guide.

For more detailed information concerning the connector interface panel, see the guide that was shipped with the chassis, the *Prisma II Chassis Installation and Operation Guide*, part number 713375.

Preparing for Installation, Continued

Rear Access Chassis Illustration

The Prisma II Chassis may be configured as front access or rear access depending on the system you have purchased. The rear access chassis is shown here.

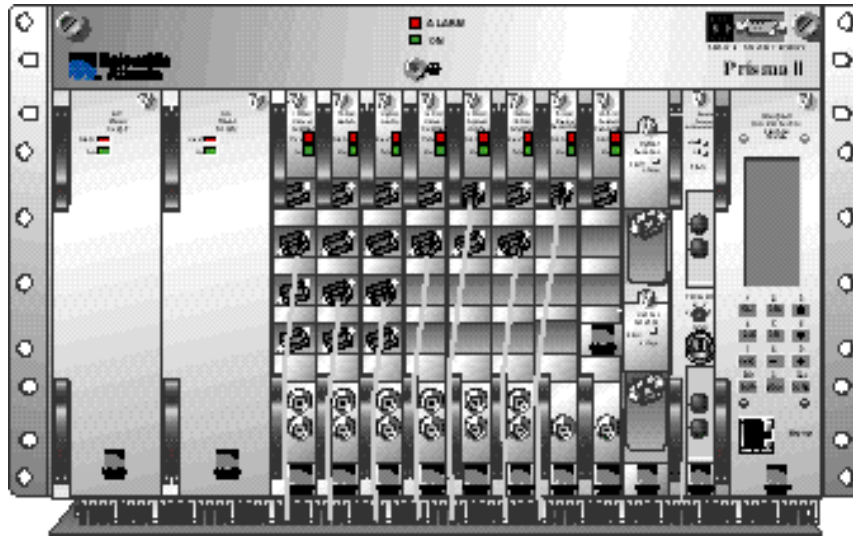

T8036

Front Access Chassis Illustration

The front access chassis is shown here.

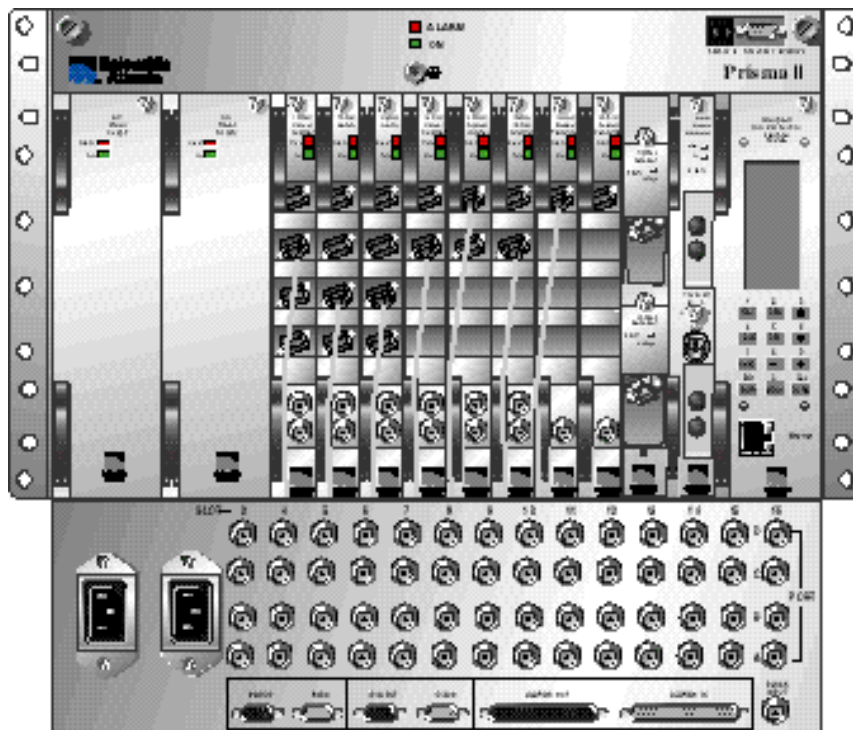

T8056

Connecting the RF Cables to the Chassis

RF Cable Connection Procedure

Follow this procedure to make the RF cable connections for the processor.

1. Locate the RF ports of the corresponding slot where the Prisma II bdr 4:1 Redundant Receive Processor is to be installed.

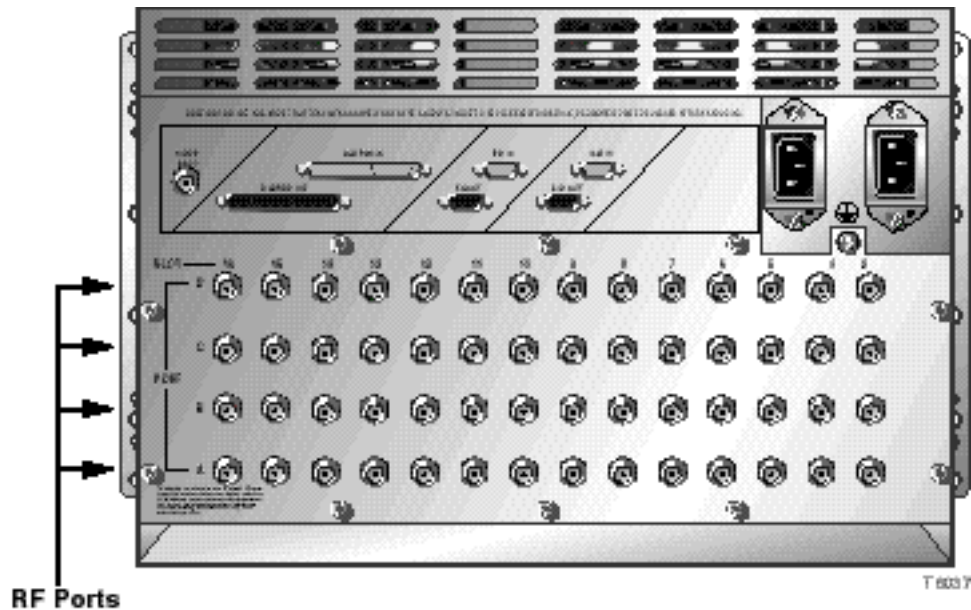

2. Attach one 75 ohm RF cable to Port A connector (RF output A) of the corresponding slot where the module is to be installed. This is the channel A RF output connection. See the illustration below.
3. Attach the other three 75 ohm RF cables to the Port B, C, and D connectors (RF outputs B, C, and D) of the corresponding slot where the processor is to be installed.

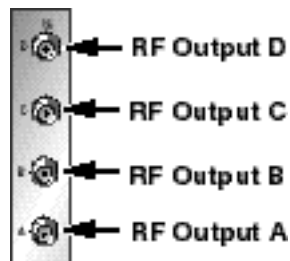

4. Route the four RF cables to the appropriate RF destinations.
5. If F-connectors are installed, use a 7/16-in. open-end wrench to secure all cables to the connectors at the chassis.
6. Proceed to **Installing the 4:1 Receive Processor in the Chassis**.

Installing the 4:1 Receive Processor in the Chassis

Installing the Receive Processor

Important: For best results, install the Prisma II bdr 4:1 Redundant Receive Processor into the Prisma II Chassis before installing the optical receiver into the processor.

To install the receive processor in the chassis, follow these steps.

1. Locate the fiber guides at the bottom of the chassis and the module guide slots inside the chassis as shown in the following illustration.

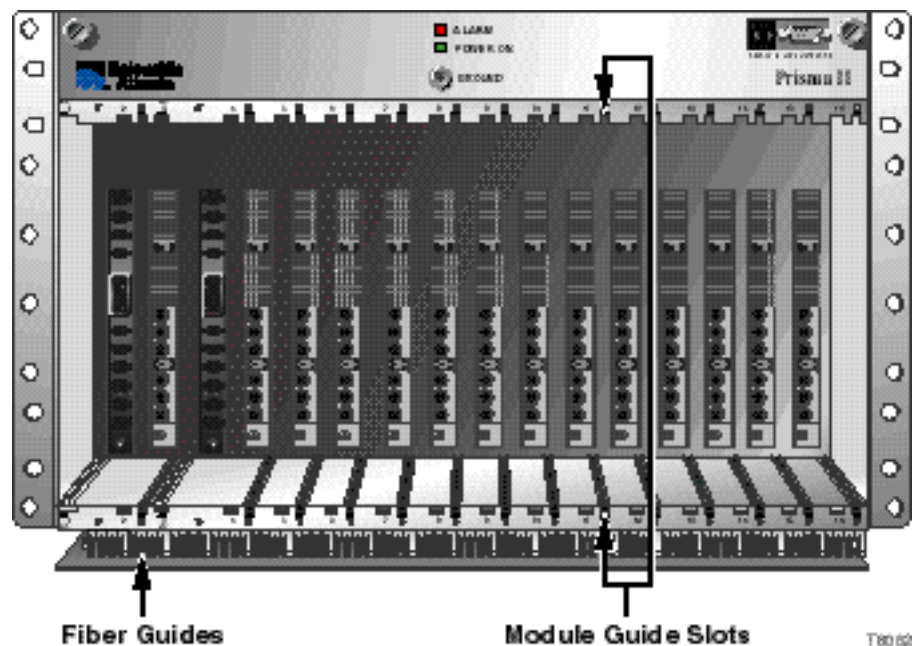

2. Align the ridges on the top and bottom of the processor with the module guide slots located on the chassis. Module ejectors must be fully extended when inserting the processor.

Installing the 4:1 Receive Processor in the Chassis, Continued

3. Gently slide the processor into the chassis until you feel the power and communications connections on the back of the module join connectors on the backplane. Use the module ejectors on the left side of the processor to lock it in place.

Note: Do not force or bang the module into the chassis. If properly aligned, it slides in with minimal force.

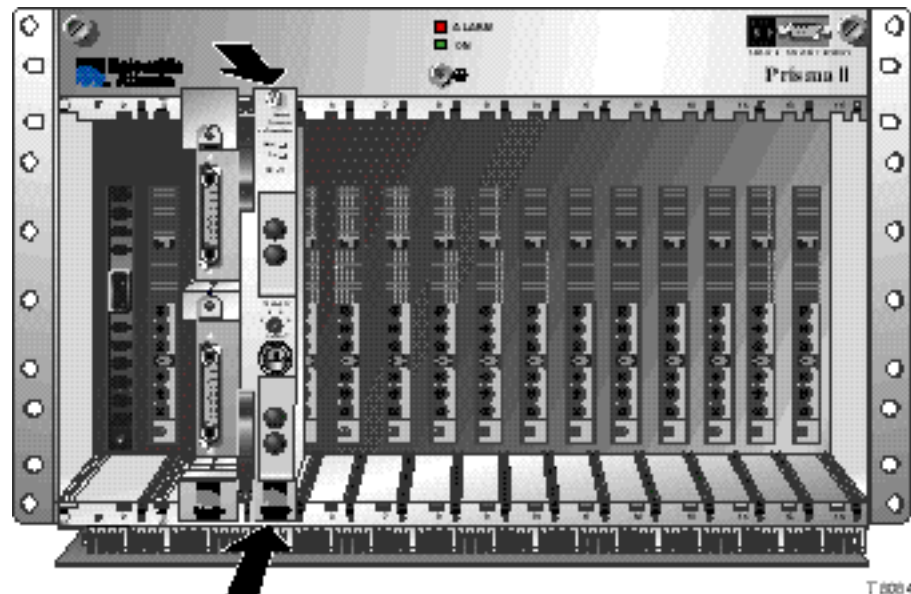

4. Hand-tighten the screw at the top of the processor, to secure it in the chassis. Use a $\frac{3}{8}$ -in. flat-blade screwdriver to secure. **Do not over tighten.**

Connecting Optical Cables

The Fiber Fish Tool

The Fiber Fish tool that was shipped along with the Prisma II Chassis is used to pull an optical cable from the rear of the chassis to the front of the chassis so the optical cables can be connected to optical connectors on the front panel of the Prisma II modules.

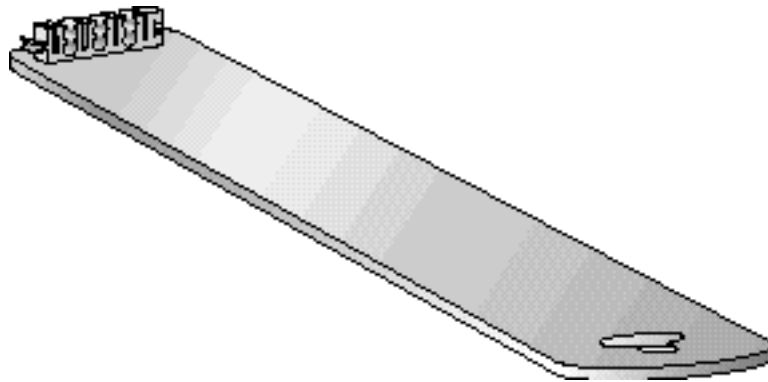

The Fiber Fish Tool Hook

At the end of the Fiber Fish tool is a small hook holds an optical cable so that you can pull it through to the front panel of the Prisma II Chassis.

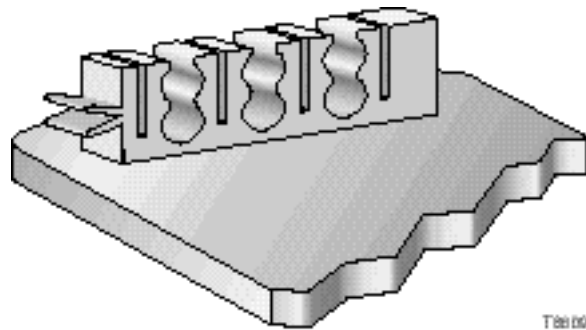

Connecting Optical Cables, Continued

Using the Fiber Fish to Pull the Optical Cable to the Prisma II Module

Important: Use a protective cap to protect the end of the optical fiber while the cable is being fished (or handled in general).

To pull the optical cable to the front of the chassis, follow these procedures.

1. Insert the Fiber Fish tool through the slot located just above the bottom of the chassis.
2. At the rear of the chassis, locate the appropriate optical cable.
3. Insert the optical cable into notched area of the Fiber Fish tool as shown.

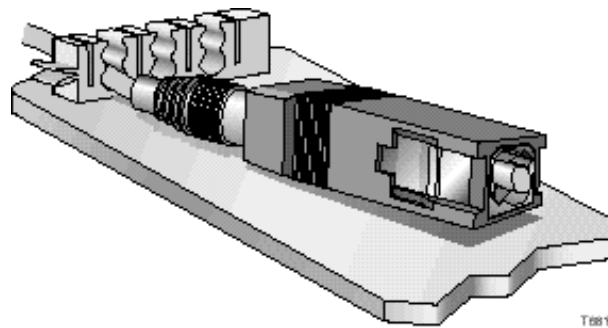

4. At the front of the chassis, pull the Fiber Fish tool (with cable attached) to the front of the chassis.
5. Disengage the optical cable from the Fiber Fish tool and remove the protective cap.
6. Attach the optical cable to the appropriate connector on the processor front panel. See **Cable Connection Procedure**.

Connecting Optical Cables, Continued

Cable Connection Procedure

Important: This procedure assumes that the Prisma II bdr Optical Receiver has not been installed in the Prisma II bdr 4:1 Redundant Receive Processor. Follow this procedure to make the optical cable connections for each optical receiver to be installed.

1. Attach one end of the optical cable to the optical input connector located on the front of the optical receiver.

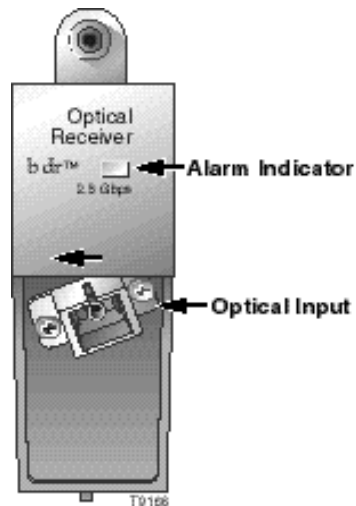

2. Route the other end of the optical cable to the appropriate optical source.
3. Repeat steps 1 and 2 for optical receiver 2.

Installing Optical Receivers in the Processor

Installing the Optical Receiver

Important: For best results, install the Prisma II bdr 4:1 Redundant Receive Processor into the Prisma II Chassis before installing the optical receivers into the processor. To install the sub-module in the processor, follow these steps.

1. Align the ridges on the top and bottom of the optical receiver with the guide slots located on the processor.

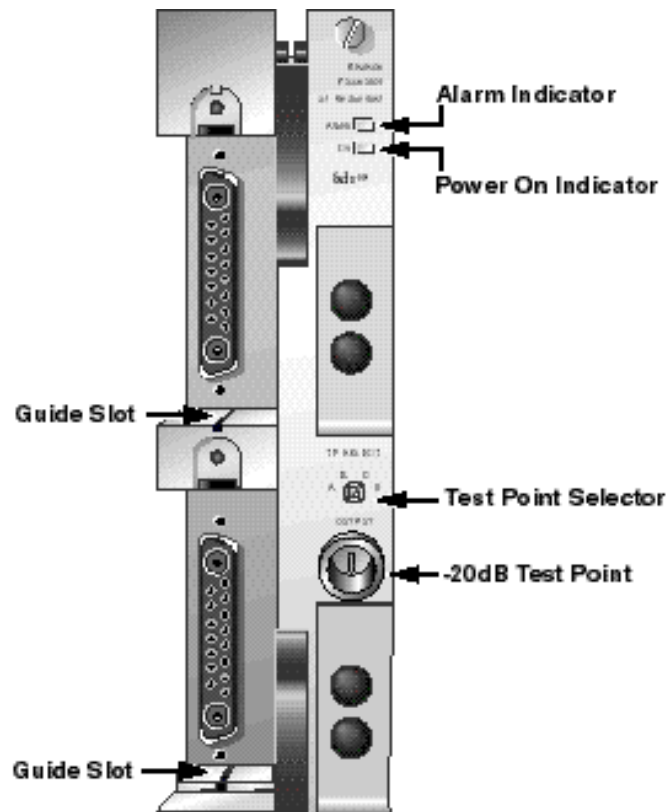

2. Gently slide the optical receiver into the processor until you feel the power and communications connections on the back of the receiver join connectors on the processor. Use the thumbscrew on the top of receiver to lock it in place.
3. Repeat steps 1 and 2 for each optical receiver.

Installing Optical Receivers in the Processor, Continued

Optical Receivers Installed

After you have installed both Prisma II bdr Optical Receiver into the bdr 4:1 Redundant Receive Processor, the assembly appears as shown below.

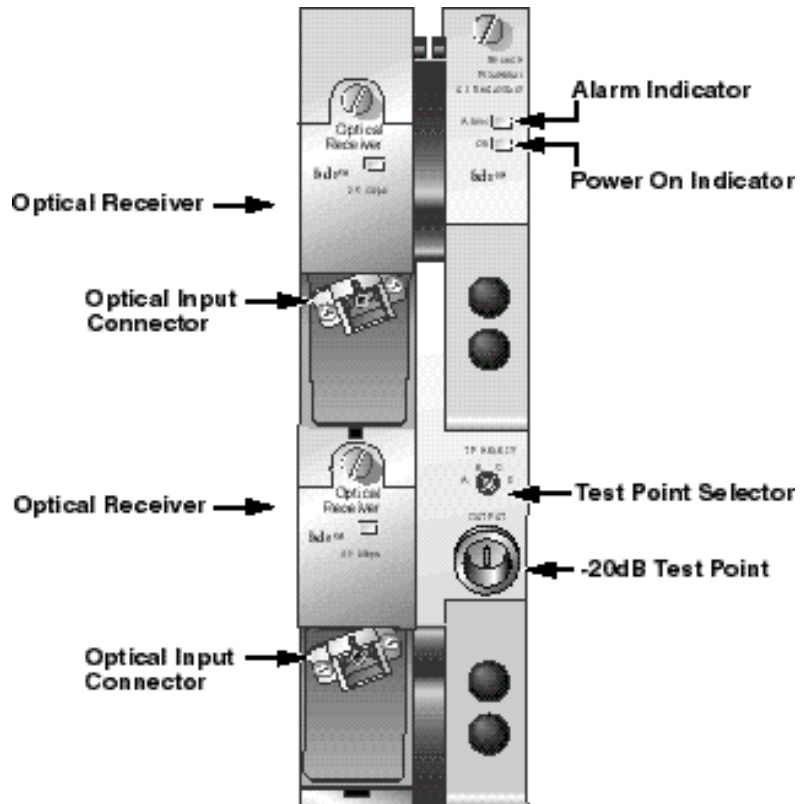

Prisma II Redundancy Interface Panel

Redundancy Interface Panel Introduction

The Prisma II Redundancy Interface Panel is an accessory to the Prisma II platform. The interface panel is intended to be used with the master/slave feature and the contact closure alarm feature of the Prisma II platform.

The terminals on the interface panel serve as extensions to the two DB-37 connectors labeled **ALARMS IN** and **ALARMS OUT** on the connector interface panel of the Prisma II Chassis.

The interface panel consists of the rack-mount panel, two cables, and jumper wire. The panel is to be mounted near the designated Prisma II Chassis in a 19-inch rack.

Slave Mode Operation in Prisma II Modules

All Prisma II modules can be hard-wired to operate as a backup or slave module in a parallel redundant mode.

In this mode, a master and a slave module are interconnected and configured so that if a critical fault occurs in the master, its output is turned off. When this occurs, the slave module senses that the master is no longer operating and is automatically enabled. If the master's critical alarm disappears (for example, by replacing the module), the slave turns off and the master is re-enabled.

Prisma II modules are factory configured in master mode. Modules must be hard-wire connected and manually reconfigured using an ICIM, the LCI software, or Transmission Network Control System (TNCS) in order to operate in slave mode.

Redundancy Interface Panel Illustration (Front)

The front of the Prisma II Redundancy Interface Panel is shown below.

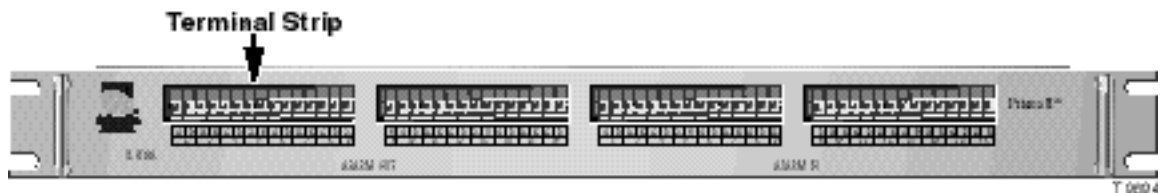

Redundancy Interface Panel Illustration (Rear)

The rear of the Prisma II Redundancy Interface Panel is shown below.

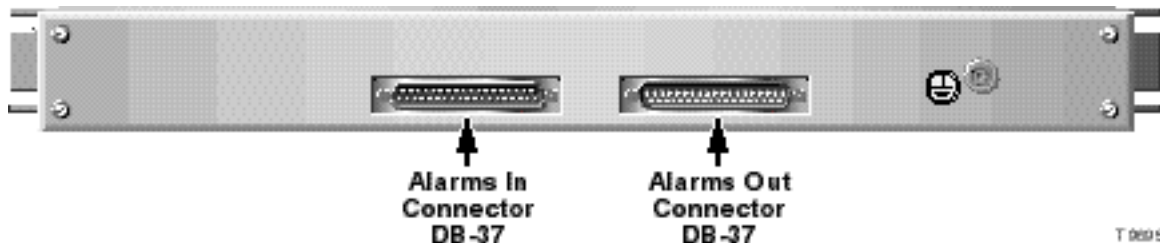

Prisma II Redundancy Interface Panel Features

Prisma II Chassis Slot Numbers

The Prisma II Chassis has sixteen slots. Each chassis slot has two alarm outputs and two alarm inputs. Slot numbers and the corresponding outputs and inputs are represented and labeled just below the terminal strips on the front of the Prisma II Redundancy Interface Panel.

Note: Slot 1 of the Prisma II Chassis is always reserved for the Prisma II Power Supply and has no terminals on the panel. Slot 3 of the Prisma II Chassis is represented on the interface panel, but is reserved for the Prisma II Fan Tray. Therefore, the interface panel's slot 3 spring terminals can only be used as alarm outputs or inputs for the Prisma II Fan Tray.

Terminals Strips

The front of the Prisma II Redundancy Interface Panel has four terminal strips that house spring terminals for each slot. The two left-side strips house two **ALARMS OUT** terminals for each of the chassis slots 2 through 16, and the two right-side strips house two **ALARMS IN** terminals for each of the chassis slots 2 through 16.

Spring Terminals

The spring terminals are the points where the actual hardwire connections between modules are made. Each spring terminal on the interface panel is an extension of a pin on the **ALARMS OUT** and **ALARMS IN** connectors on the Prisma II Chassis. Pressing the bottom lever of the spring terminal allows insertion of a jumper wire into the hole of the terminal. Releasing the lever secures the wire to the terminal.

Alarm Terminal Designations

The **ALARMS OUT** and **ALARMS IN** terminal strips, chassis slot numbers, and A/B spring terminals are labeled just below the terminal strips on the front of the interface panel.

Redundancy Interface Panel Cables

The two supplied DB-37 cables serve as extensions of the **ALARMS IN** and **ALARMS OUT** connectors on the Prisma II Chassis.

Jumper Wire

The 20-gauge insulated jumper wire is used to make hardwire connections between spring terminals. It is to be cut to length, end-stripped, and inserted in the spring terminal.

Wire Routing Clips

Wire routing clips are used to gather loose jumper wires near the interface panel.

Interface Panel Installation and Connections

Redundancy Interface Panel Installation

Follow the steps below to install the Prisma II Redundancy Interface Panel.

1. Position the interface panel in the rack near the designated Prisma II Chassis.
2. Insert a mounting screw through each of the four mounting slots on the front of the interface panel, and then into the rack. (Screws are not included.)
3. Use an appropriate screwdriver to tighten each mounting screw until it is tight.
4. Tie the interface panel to earth ground via the ground stud (ground cable not included).

Important: Grounding the Prisma II Redundancy Interface Panel via the ground stud is especially important for ESD and EMC performance.

Connecting the Redundancy Interface Panel to the Prisma II Chassis

Follow the steps below to connect the Prisma II Redundancy Interface Panel to the Prisma II Chassis.

1. Connect the female end of one DB-37 cable to the male end **ALARMS OUT** connector on the Prisma II Chassis.
2. Connect the male end of the same DB-37 cable to the female end **ALARMS OUT** connector on the rear of the interface panel.
3. Connect the male end of the second DB-37 cable to the female end **ALARMS IN** connector on the Prisma II Chassis.
4. Connect the female end of the second DB-37 cable to the male end **ALARMS IN** connector on the rear of the interface panel.

Connecting a Slave Module to a Master Module Using the Prisma II Redundancy Interface Panel

Follow the steps below to connect a slave module to a master module using the Prisma II Redundancy Interface Panel.

1. On the **ALARMS OUT** strip at the front of the interface panel, locate the slot number representing the chassis slot location of the master module. Connect one end of a jumper wire to spring terminal A of that slot number.
2. Connect the other end of the same jumper wire to the A terminal of the slot of the slave module on the **ALARMS IN** connector. This connection may or may not be on the same interface panel.

Interface Panel Installation and Connections, Continued

3. Repeat steps 1 and 2 for the B terminals of both the master and the slave module's **ALARMS IN** and **ALARMS OUT** terminal strips.
4. Upon connecting all wires, adhere the wire routing clips to the interface panel and connect the wires onto the clips.

Configuring Prisma II Modules as Master or Slave

To configure a module as master or slave, Use the ICIM, LCI, or TNCS software as shown in the guide that was shipped with the specific Prisma II module.

Checking the Master/Slave Connection

Follow the steps below to verify that the master/slave connection is operating properly.

1. Ensure that all master and slave modules are installed, power is applied to your system, and that all cable connections between chassis and the interface panel(s) are secure.
2. Ensure that the primary module is configured to operate as a "master", and the backup module is configured to operate as a "slave" (or as "externally redundant" when connecting bdr processors).
3. Ensure that all jumper wires are securely connected to the proper terminals.
4. When the system is powered and properly configured, remove the master module and verify that the slave module turns on and begins operation. If the slave does not operate, review the installation and connection steps given in this section.

Master/Slave Connections

Redundancy Interface Panel Terminal Strips

On the interface panel terminal strips, all chassis slots except for slot 1 and slot 3 are available. Each chassis slot has two outputs (A and B) and two inputs (A and B) for communication of alarm information to or from other modules. However, on most Prisma II modules, the B output is disabled. See the note below.

Typical Master/Slave Jumper Connections for Modules in the Same Chassis

The diagram below shows the **ALARM OUT** and **ALARM IN** terminal strips and jumper connections for a typical master/slave connection between two modules in the same Prisma II Chassis. The master module is assumed to be in slot 4 and the slave module is in slot 6. If a critical fault occurs in the master module, its relay signal travels from the slot 4 **ALARM OUT** terminal to the slave module slot 6 **ALARM IN** terminal. This turns on the slave module in slot 6. The slave module continues in operation until the master module is fixed. At that time the master module automatically takes over and the slave module switch relay turns off.

Note: The Prisma II Dual Reverse Receiver is the only Prisma II module that requires a second jumper to be connected to the B terminal of the **ALARM OUT** strip for master/slave operation. A single jumper wire from the A terminal of the master to the A terminal of the slave is the only jumper connection required for master/slave operation with all other Prisma II modules. The connection using the B terminals for backing-up a Prisma II Dual Reverse Receiver, is shown as the dotted line.

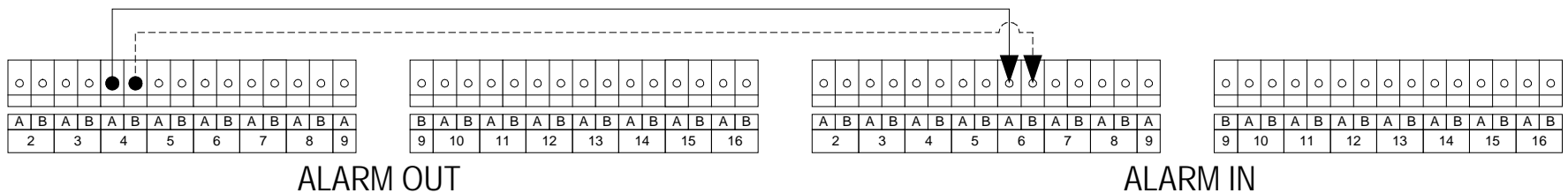

Master/Slave Connections, Continued

Typical Master/Slave Jumper Connections for Modules in Separate Prisma II Chassis

Important! Each Prisma II Chassis that is used for alarm connections must have a separate, dedicated Prisma II Redundancy Interface Panel.

The diagram below shows jumper connections for a typical master/slave connection between two modules in separate Prisma II Chassis. The master module is shown in chassis 1-slot 4 and the slave module is in chassis 2-slot 6. If a critical fault occurs in the master module, its relay signal is carried via the jumpers, from the chassis 1-slot 4 **ALARM OUT** terminal to the chassis 2-slot 6 **ALARM IN** terminal. This turns on the slave module located in chassis 2-slot 6. The slave module continues in operation until the master module is fixed. At that time, the master module automatically takes over and the slave module switch relay turns off.

Note: The Prisma II Dual Reverse Receiver is the only Prisma II module that requires a second jumper to be connected to the B terminal of the **ALARM OUT** strip for master/slave operation. A single jumper wire from the A terminal of the master to the A terminal of the slave is the only jumper connection required for master/slave operation with all other Prisma II modules. The connection using the B terminals for backing-up a Prisma II Dual Reverse Receiver, is shown as the dotted line.

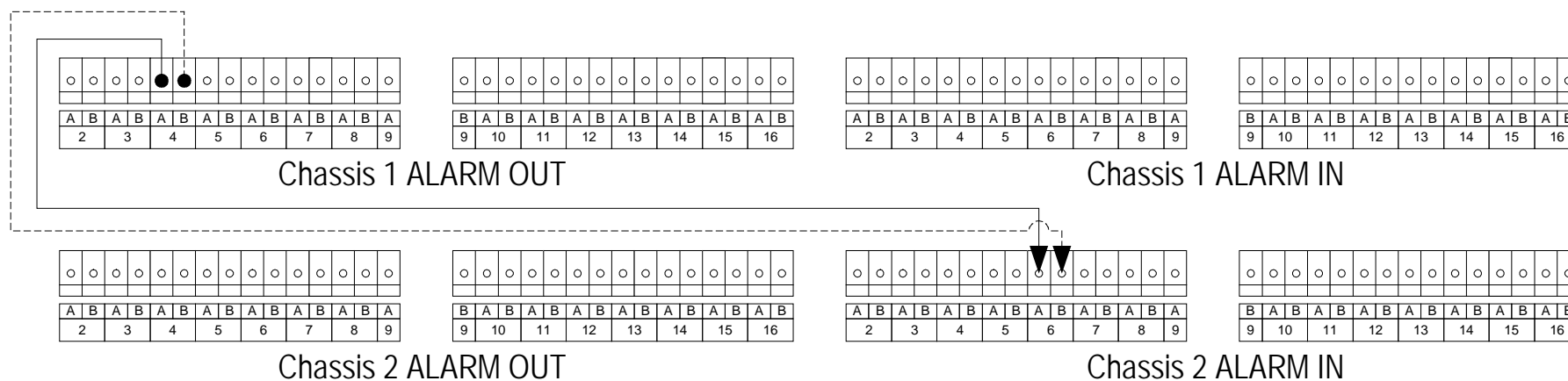

Chapter 3

Operation Using the ICIM

Overview

Introduction

The procedures in this chapter apply if you are using the Prisma II Intelligent Communications Interface Module (ICIM) to configure and operate the Prisma II bdr 4:1 Redundant Receive Processor.

Scope of This Chapter

Included in this chapter are descriptions of the ICIM front panel and the ICIM LCD, and detailed procedures on how to use the software menus to configure the receive processor.

In This Chapter

This chapter contains the following topics.

Topic	See Page
ICIM Introduction	3-2
The ICIM Front Panel	3-3
The ICIM Password	3-6
Operating the ICIM	3-12
Monitoring Operating Status Using the ICIM	3-16
Configuring the bdr 4:1 Receive Processor Using the ICIM	3-20
Checking bdr 4:1 Receive Processor Alarms Using the ICIM	3-24
Checking Manufacturing Data Using the ICIM	3-29
Using the ICIM to Save the Configuration	3-32



WARNING:

Avoid damage to your eyes! Do not look into any optical connector while the system is active. Even if the unit is off, there may still be hazardous optical levels present.

ICIM Introduction

ICIM Function

The ICIM functions as the user interface to the application modules as well as the interface between the Prisma II modules and the Transmission Networks Control Systems (TNCS) software. The ICIM allows local module configuration and status monitoring for up to 82 modules located in multiple chassis. The ICIM features easy-to-use software that is navigated using the numeric keypad and the LCD display.

Important: Do not operate any Prisma II Chassis without a fan tray installed properly. If a fan tray is not installed in the Prisma II Chassis, the ICIM will not communicate with any of the modules in that chassis.

Important: All chassis connected in a “daisy-chain” must be powered and have a fan tray installed. A chassis that is connected but is either not powered, or does not have a fan tray installed will cause faulty operation of the ICIM.

Important: All chassis connected in this “daisy-chain” must have a unique chassis I.D. number.

ICIM Block Diagram

The ICIM is illustrated in the block diagram below.

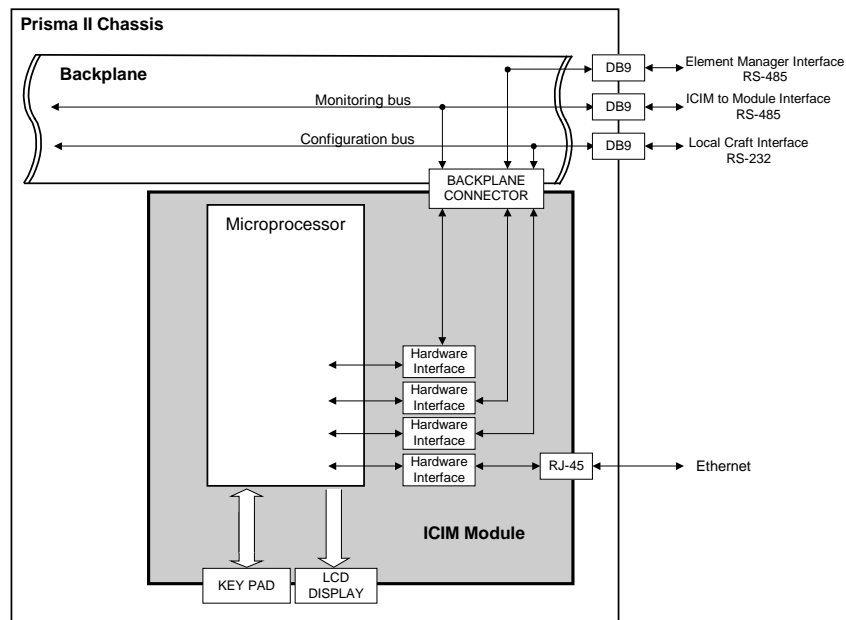

The ICIM Front Panel

ICIM Front Panel Illustration

The illustration below shows the front panel of the ICIM.

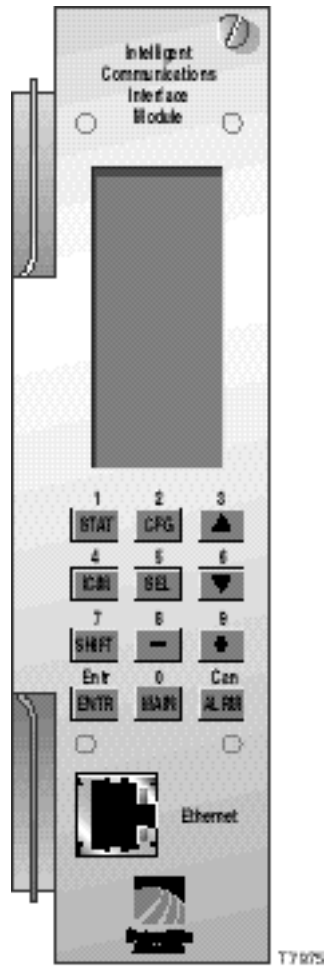

The ICIM Front Panel, Continued

ICIM Front Panel Features

Part	Function
LCD screen	Displays the ICIM menus, alarms, and status information.
12-key numeric keypad	Used to navigate the ICIM's menus and configure the application modules.
Ethernet connector	Directly connects the ICIM to a network (future release).

The ICIM LCD

The ICIM LCD is the operator's visual link to the ICIM software. When the ICIM is installed and powered up, the **MAIN** menu is displayed on the LCD. The following illustration shows the ICIM's **MAIN** menu.

MAIN

Offline

Modules
15

Alarms
0













Scroll

Module
Shelf
Slot

The ICIM Front Panel, Continued

The ICIM Key Pad

The ICIM keypad has twelve keys for entering and monitoring operational parameters. The table below lists each key and a brief description of its function.

Button	Function
	Displays status information for the selected module
	Displays configuration information for the selected module
	Displays all of the parameters in alarm for a selected module
	Moves the menu selection area up
	Moves the menu selection area down
	Selects the highlighted parameter
	Displays ICIM module information such as firmware version, serial number, and baud rate
	Shifts function of a keypad button to the function or number label just above that button
	Decreases numerical readings of selected configuration parameters
	Increases numerical readings of selected configuration parameters
	Enters input data (if valid)
	Exits the current menu and displays the MAIN menu

The ICIM Password

Using the ICIM Password

The ICIM allows you to send configuration commands, to check alarms and operating status, and restore factory default settings in Prisma II modules. In order to ensure that no unauthorized changing of these parameters occurs, you have the option of using a password protection system. Password authorization only applies to the configurable parameters. Status and alarm information is always available on the ICIM regardless of password implementation.

The password system consists of:

- The User password - **User Psw**. A user-settable password. The User password is created, entered, and changed by the system operator(s). The password must be exactly eight digits using only the 0-9 number keys.
- The ability to change an existing User password - **Change Psw**.
- The ability to disable the User password function - **Disable Psw**.
- A service password - **SA Psw**. Used only by Cisco personnel.

Important: If you only want to monitor status and alarm data, simply skip the password function when it appears on the ICIM menu. You can access all module status and alarm information without a password. However, once a user password is entered, you are required to enter it every time you want to set configurable parameters to any module controlled by that ICIM. See **Expired Password or Inactive Password Messages** and **Entering the User Password** that follow.

The ICIM Password, Continued

Accessing the Password Function

The Password menu allows you to create, enter, change, or disable the user password. It also allows service personnel to use the Cisco (SA) password. To access the Password menu, follow the steps below.

1. Press the **ICIM** key.
2. Use the **▼** key to scroll down until **Password** is highlighted.
3. Press the **SEL** key. The Password menu is displayed. **User Psw** is highlighted.

MAI N ----- Off line ----- Modules 0 Alarms 0 ----- Scroll ----- Module Shelf Slot	ICIM ----- Shelf 0 Slot 15 ----- Mfg Data ----- Password ----- Update Adr	ICIM ----- Shelf 0 Slot 15 ----- Mfg Data ----- Password ----- Update Adr	ICIM ----- Shelf 0 Slot 15 ----- User Psw ----- SA Psw ----- Change Psw ----- Disable Psw
---	--	--	---







Expired Password or Inactive Password Messages

The entry of a valid User or SA password allows changes to system parameters for a period of 10 minutes. If more than 10 minutes has passed since your last keystroke, and you attempt to make any changes to system parameters, the menu displays **Psw Expired**. If, after more than 10 minutes, you attempt to disable the password the menu displays **Failed, Password Not Active**. If either of these messages is displayed, you are required to re-enter the password. To re-enter the password, follow the procedure in the section **Entering or Enabling the User Password**.

The ICIM Password, Continued

Using Your Password for the First Time

Important: To enter a User password in an ICIM that has never had the User password function implemented, follow the steps in the procedure below.

1. Access the password function as shown in **Accessing the ICIM Password Function**.
2. Use the  key to scroll down until **Change Psw** is highlighted.
3. Press the  key. **Change Psw/Shift Off** is displayed.
4. Press the  key to display **Shift On** - then enter 8 digits as your User password, using the 0-9 number keys. If at any time you input a digit that is incorrect or you wish to change a digit, use the **CAN** (Cancel) function by pressing the  key to delete that digit.
5. Press the  key. The ICIM updates the display to show if your password entry was accepted or rejected. If the entry was accepted, you are able to return to the MAIN menu.
6. If the password you entered is rejected, press the  key to return to the password function, then re-enter an 8-digit password using only the 0-9 number keys. Press the  key.

Reasons for a User password to be rejected include:

- Entering more than 8 digits for the password
- Pressing keys other than the 0-9 number keys
- Entering an incorrect password if a valid password has been entered

The ICIM Password, Continued

Re-Entering a User Password

If more than 10 minutes have passed since your last keystroke, and you attempt to make any changes to system parameters, the menu displays **Psw Expired**. If you attempt to disable the password, the menu displays **Failed, Password Not Active**. When either of these messages is displayed, you must re-enter the User password as outlined in the steps below.

1. Access the password as described in **Accessing the Password Function**.
2. Press the **SEL** key. **User Psw/Shift Off** is displayed.
3. Press the **SHIFT** key to display **Shift On** - then enter the 8 digits of the User password, using the 0-9 number keys. If at any time you input a digit that is incorrect or you wish to change a digit, use the **CAN** (Cancel) function by pressing the **ALRM** key to delete that digit.
4. Press the **ENTER** key. The ICIM updates the display to show if your password entry was accepted or rejected. If the entry was accepted, you are able to return to the MAIN menu.
5. If the password you entered is rejected, press the **SHIFT** key to return to the password function, then re-enter your password. Press the **ENTER** key.

Reasons for a User password to be rejected include:

- Entering more than 8 digits for the password
- Pressing keys other than the 0-9 number keys
- Entering an incorrect password if a valid password has been entered







ICIM	ICIM	ICIM	ICIM
----- Shelf 0 Slot 15 -----	----- Shelf 0 Slot 15 -----	----- Shelf 0 Slot 15 -----	----- Shelf 0 Slot 15 -----
User Psw	User Psw *****	User Psw 1234****	User Psw 12345678
-----	-----	-----	-----
Shift Off	Shift On	Rejected Shift Off	Accepted Shift Off

The ICIM Password, Continued

Changing the User Password

Important: The current User password must be active prior to changing it. If the current password has expired (more than 10 minutes have passed since your last keystroke), you must re-enter the current password before changing to a new one.

Follow the steps below to change the User password.

1. Access the password function as shown in the procedure **Accessing the Password Function**.
2. Use the  key to scroll down until **Change Psw** is highlighted.
3. Press the  key to select **Change Psw**.
4. When **Change Psw /Shift Off** is displayed, press the  key to display **Shift On** - then enter the 8 digits of your new password, using the 0-9 number keys. If you input a digit that is incorrect or wish to change a digit, use the **CAN** (Cancel) function by pressing the  key to delete that digit.
5. Press the  key to. The ICIM updates the display to show if your password entry was accepted or rejected. If the entry was accepted, you are able to return to the MAIN menu.
6. If the new password you entered is rejected, press the  key to return to the password function, then re-enter the new 8-digit password. Press the  key.

ICIM	ICIM	ICIM	ICIM
----- Shelf 0 Slot 15 ----- User Psw ----- SA Psw ----- Change Psw ----- Disable Psw	----- Shelf 0 Slot 15 ----- Change Psw ----- Shift Off	----- Shelf 0 Slot 15 ----- Change Psw * * * * * ----- Shift On	----- Shelf 0 Slot 15 ----- Change Psw 8 7 6 5 4 3 2 1 ----- Shift On

The ICIM Password, Continued

Disabling the User Password

If a User password has been entered, you may disable it at any time. However, the current password must be active prior to disabling it. If the current password has expired (more than 10 minutes have passed since your last keystroke), you must re-enter the current password before disabling it.

1. Press the **ICIM** key.
2. Use the **▼** key to scroll down until **Password** is highlighted.
3. Press the **SEL** key.
4. Use the **▼** key to scroll down until **Disable Psw** is highlighted.
5. Press the **SEL** key to select **Disable Psw**.
6. If the current password is active, the menu displays **Password Is Now Disabled**. You can now make changes to parameters without any password.
7. If the current password has expired (more than 10 minutes have passed since your last keystroke), the menu displays **Failed, Password Not Active**. You must re-enter the current password and then repeat this procedure.

ICIM	ICIM	ICIM
----- Shelf 0 Slot 15 ----- User Psw ----- SA Psw ----- Change Psw ----- Disable Psw -----	----- Shelf 0 Slot 15 ----- ----- ----- Password Is Now Disabled ----- Shift Off	----- Shelf 0 Slot 15 ----- ----- ----- Failed, Password Not Active ----- Shift Off

Operating the ICIM

Using the ICIM

Once the module is installed as described in Chapter 2, it runs without the aid of an operator. Unless alarms are generated or your system configuration changes, you should not need to make any adjustments to the module beyond the initial setup.

Accessing the ICIM LCD Contrast

To access the ICIM LCD contrast control from the MAIN menu, press the **ICIM** key. Use the **+** key to increase or the **-** key to decrease ICIM display contrast.

The MAIN Menu

A few seconds after power-up, the MAIN menu (shown below) is displayed. Press the **SEL** key to select the specific option.

Display	Description
Offline	Indicates TNCS communication status with the ICIM
Modules	Indicates the number of modules in the ICIM domain.
Alarms	Displays the number of modules that are in alarm. Selecting this option allows scrolling through all modules in alarm condition.
Scroll	Allows scrolling through all modules in the ICIM domain.
Module Shelf Slot	Allows selection of any specific module in the ICIM domain.

MAIN

Offline

Modules
15

Alarms
0

Scroll

Module
Shelf
Slot

Operating the ICIM, Continued

Prisma II ICIM Menu

To display the ICIM menu, press the **ICIM** key. The ICIM menu (shown below) is displayed. Press the **SEL** key to select the specific option.

Display	Description
Shelf Slot	Displays the location of the ICIM module. Shelf = Chassis ID number on the front of the chassis. Slot = Slot number in the chassis.
Mfg Data	Displays manufacturing data about the ICIM.
Password	Allows you to enter, change, or disable a system password. See The ICIM Password earlier in this chapter.
Update Adr	If the Chassis ID number switch has been changed, you must highlighted the Update Adr menu and press the SEL key for the ICIM to recognize the change.

ICIM	
Shelf	0
Slot	15

Mfg Data	

Password	

Update Adr	

ICIM	
Shelf	0
Slot	15

Mfg Data	

Password	

Update Adr	

ICIM	
Shelf	0
Slot	15

Mfg Data	

Password	

Update Adr	

Operating the ICIM, Continued

Prisma II MAIN Menu and ICIM Menu Structure

Pressing the **MAIN** key initiates the MAIN software menu. Pressing the **ICIM** key initiates the ICIM software menu. The MAIN and ICIM software structures are shown below.

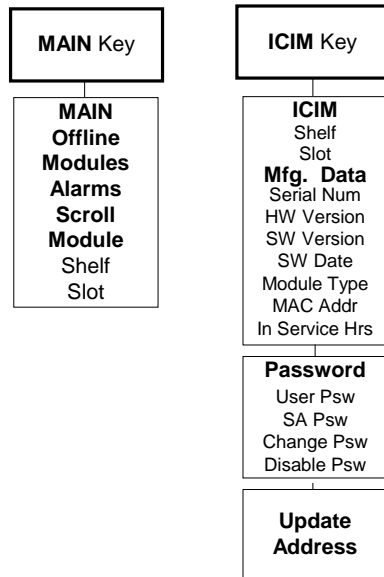

Operating the ICIM, Continued

Prisma II bdr 4:1 Redundant Receive Processor Software Menu Structure

From the MAIN or SCROLL menus, you can navigate to the Prisma II bdr 4:1 Redundant Receive Processor MODULE menu. From the MODULE menu, press the **STAT**, **CFG**, or **ALRM** key to display the desired parameter menu.

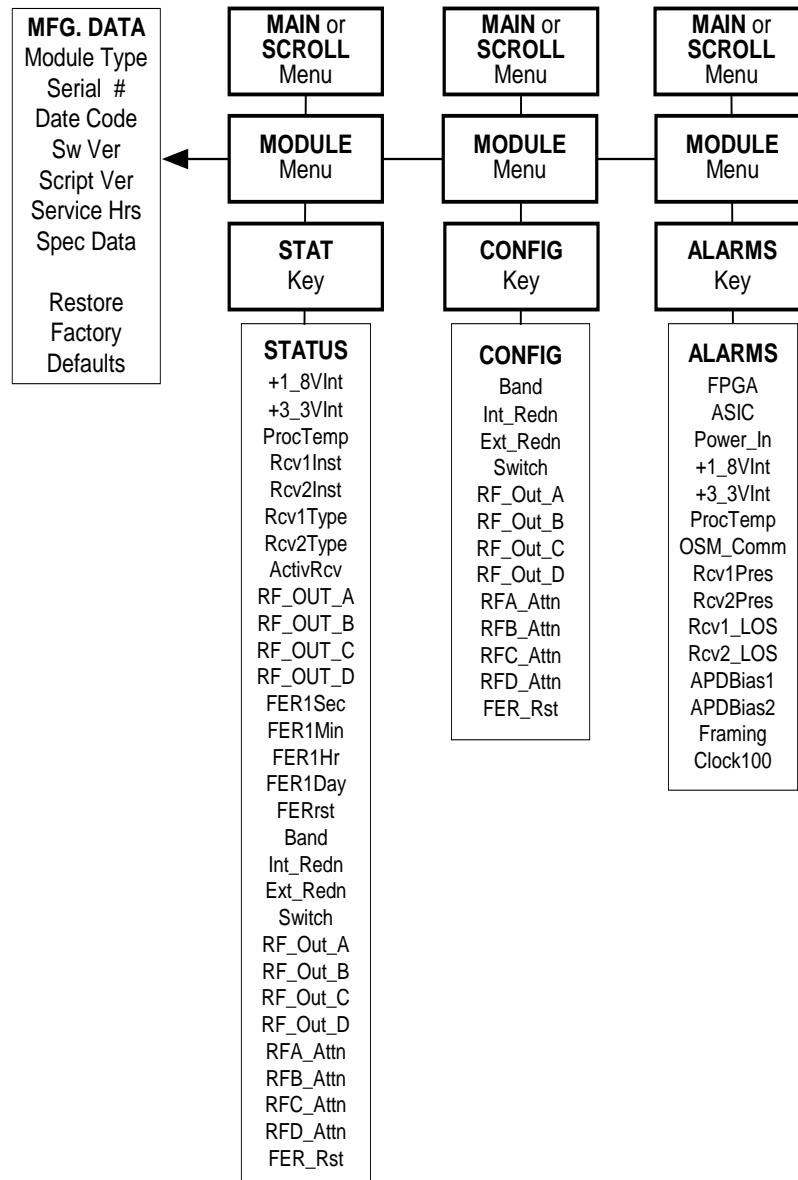

Monitoring Operating Status Using the ICIM

Monitored Parameters

You can monitor the status of operating parameters. The table below describes the monitored parameters for this module.

Parameter	Units	Function
+1_8VInt	V	Internal voltage level-nominal 1.8 V DC.
+3_3VInt	V	Internal voltage level-nominal 3.3 V DC.
ProcTemp	°C	Indicates processor temperature.
Rcv1Inst Rcv2Inst	Yes or No	Indicates if optical receivers 1 and 2 are installed.
Rcv1Type Rcv2Type	1 or 2	Indicates the type of optical receiver installed. 1 = standard range optical receiver - PIN 2 = extended range optical receiver - APD
ActivRcv	1 or 2	Indicates which optical receiver is in use.
RF_OUT_A RF_OUT_B RF_OUT_C RF_OUT_D	On, Off, Auto	Indicates the output status for each RF channel. . If On , the output is not muted. If Off , the output is muted. If Auto , the processor has muted the output.
FER1Sec FER1Min FER1Hr FER1Day	Number to 3 decimal places.	Indicates the frame error rate for the last second, minute, hour, or day.
FERrst	Number using scientific notation	Indicates the frame error rate since the last reset.
Band	MHz	Indicates how the frequency bandwidth of the processor has been set in the CONFIG menu.
Int_Redn	Yes or No	Indicates if the CONFIG menu has been set for a second optical receiver (in the same processor) to be redundant. If Yes , a receiver in the same processor acts as a backup to the primary receiver. If No , internal redundancy is off.
Ext_Redn	Yes or No	Indicates if the CONFIG menu has been set for a second optical receiver (in a separate processor) to be redundant. If Yes , a receiver in a separate processor acts as a backup to the primary receiver. If No , external redundancy is off.

Monitoring Operating Status Using the ICIM, Continued

Parameter	Units	Function
Switch	Deflt_1 Deflt_2 Force_1 Force_2	Indicates whether Deflt_1 or Deflt_2 and Force_1 or Force_2 switch settings have been set in the CONFIG menu.
RF_Out_A RF_Out_B RF_Out_C RF_Out_D	Auto, On or Off	Indicates how each RF output is actually set in the CONFIG menu. If On , the output is not muted. If Off , the output is configured to be mute. If Auto , the processor has muted the output.
RFA_Attn RFB_Attn RFC_Attn RFD_Attn	dB	Indicates amount of attenuation that has been set set in the CONFIG menu for the RF outputs of each channel.
FER_Rst	Count or Reset	Indicates how the frame error reset function is set in the CONFIG menu. If Count , the processor continuously counts all frame errors since the last reset. When Reset is selected, the processor restarts the frame error rate counter.

Checking Operating Status

Using the ICIM, you can check the status of all operating parameters of this module. To monitor the module operating parameters, follow these steps.

1. From the MAIN menu, press the key to highlight **Shelf** and **Slot** fields.
2. Press the key to address the **Shelf** number. Then press the key or the key to scroll to the number of the desired shelf.
3. Press the key. The **Slot** field is highlighted.
4. Press the key or the key to scroll to the number of the desired slot.
5. Press the key. The information for the module of interest is now displayed on the ICIM menu.
6. Press the key.
7. Press the key or the key to scroll through the monitored parameters until you find the parameter of interest.
8. Check the status of the desired parameter or select other parameters to monitor. When finished, press the key to return to the MAIN menu.

Monitoring Operating Status Using the ICIM, Continued

STATUS Menus

Press **STAT** to select the **STATUS** menu. Some typical **STATUS** menus are shown below.

STATUS	
Shelf	0
Slot	8

bdr 4:1	
RECEIVE	
PROCESSOR	

+1_8VInt	
1.814 V	

+3_3VInt	
3.296 V	
▲ ▼	

STATUS	
Shelf	0
Slot	8

bdr 4:1	
RECEIVE	
PROCESSOR	

ProcTemp	
46.25 C	

Rcv1Inst	
Yes	
▲ ▼	

STATUS	
Shelf	0
Slot	8

bdr 4:1	
RECEIVE	
PROCESSOR	

Rcv2Inst	
Yes	

Rcv1Type	
1	
▲ ▼	

STATUS	
Shelf	0
Slot	8

bdr 4:1R	
RECEIVE	
PROCESSOR	

Rcv2Type	
1	

ActivRcv	
1	
▲ ▼	

STATUS	
Shelf	0
Slot	8

bdr 4:1R	
RECEIVE	
PROCESSOR	

RF_OUT_A	
Auto	

RF_OUT_B	
Auto	
▲ ▼	

STATUS	
Shelf	0
Slot	8

bdr 4:1R	
RECEIVE	
PROCESSOR	

RF_OUT_C	
Auto	

RF_OUT_D	
Auto	
▲ ▼	

STATUS	
Shelf	0
Slot	8

bdr 4:1R	
RECEIVE	
PROCESSOR	

FER1Sec	
0.000FER	

FER1Min	
0.000FER	
▲ ▼	

STATUS	
Shelf	0
Slot	8

bdr 4:1R	
RECEIVE	
PROCESSOR	

FER1Hr	
0.000FER	

FER1Day	
0.000FER	
▲ ▼	

Monitoring Operating Status Using the ICIM, Continued

STATUS	
Shelf	0
Slot	8

bdr 4:1R RECEIVE PROCESSOR	

FER_Rst 2e+09 FE	

Band 1	
▲ ▼	

STATUS	
Shelf	0
Slot	8

bdr 4:1R RECEIVE PROCESSOR	

Int_Redn Yes	

Ext_Redn No	
▲ ▼	

STATUS	
Shelf	0
Slot	8

bdr 4:1R RECEIVE PROCESSOR	

Switch Deflt_1	

RF_Out_A Auto	
▲ ▼	

STATUS	
Shelf	0
Slot	8

bdr 4:1R RECEIVE PROCESSOR	

RF_Out_B Auto	

RF_Out_C Auto	
▲ ▼	

STATUS	
Shelf	0
Slot	8

bdr 4:1R RECEIVE PROCESSOR	

RF_Out_D Auto	

RFA_Attn 0 dB	
▲ ▼	

STATUS	
Shelf	0
Slot	8

bdr 4:1R RECEIVE PROCESSOR	

RFB_Attn 0 dB	

RFC_Attn 0 dB	
▲ ▼	

STATUS	
Shelf	0
Slot	8

bdr 4:1R RECEIVE PROCESSOR	

RFD_Attn 0 dB	

FER_Rst Count	

Configuring the bdr 4:1 Receive Processor Using the ICIM

Configurable Parameters

Configurable parameters for this module include the following.

Parameter	Function	Values	Default
Band	Band selection for the ASIC.	5-40 MHz or 7-42 MHz or 10-45 MHz	7-42 MHz
Int_Redn	Internal Redundancy. If Yes , the module will generate an alarm if either optical receiver is removed. If No , no alarm is generated unless both optical receivers are removed.	Yes or No	Yes
Ext_Redn	External Redundancy Mode. If Yes , the processor acts as a backup to another processor and is enabled when an external connection indicates the primary processor has failed.	Yes or No	No
Switch	Determines how the channels are switched. Deflt_1 and Deflt_2 will select which is the default optical receiver. Force_1 and Force_2 will force switch to either receiver 1 or receiver 2, regardless of any errors.	Deflt_1 Deflt_2 Force_1 Force_2	Deflt_1
RF_Out_A RF_Out_B RF_Out_C RF_Out_D	Controls the muting of RF channels A, B, C, and D. If Auto , the processor determines whether the RF output should be muted (based on alarms such as missing receiver or loss of signal). If On , the output is not muted. If Off , the output is muted.	Auto, On, Off	Auto
RFA_Attn RFB_Attn RFC_Attn RFD_Attn	Attenuates the RF Output of channel A. Attenuates the RF Output of channel B. Attenuates the RF Output of channel C. Attenuates the RF Output of channel A.	-6 dB to +6 dB in 0.5 dB steps	0 dB
FER_Rst	Frame error reset. If Count , processor counts frame errors since last reset. If Reset , restarts the count.	Count or Reset	Count

Important: After using the **Reset** function (FER_Rst), the frame error rate counter must be returned to the **Count** configuration in order to enable the frame error rate counter. If left in **Reset**, the counter will be in a continuous reset mode and will not display a frame error rate.

Configuring the bdr 4:1 Receive Processor Using the ICIM, Continued

Configuring Parameters

Using the ICIM, you can configure the parameters listed above. To configure the parameters, follow these steps.

1. From the MAIN menu, press the key to highlight the **Shelf** and **Slot** fields.
2. Press the key to address the **Shelf** number. Then press the key or the key to scroll to the number of the desired shelf.
3. Press the key. The **Slot** field is highlighted.
4. Press the key or the keys to scroll to the number of the desired slot.
5. Press the key. The initial information for the module of interest is now displayed on the ICIM menu.
6. To configure the module, press the key.
7. Press the key or the key to scroll through the configurable controls until you find the parameter of interest.
8. Press the key to select the highlighted control.
9. Press the key or the key to activate or change the value of the selected control.
10. Press the key to save the changes and return to the MAIN menu.

Configuring the bdr 4:1 Receive Processor Using the ICIM, Continued

CONFIG Menus

Some typical Prisma II bdr 4:1 Redundant Receive Processor CONFIG menus are shown below.

<pre> CONF I G ----- Shelf 0 Slot 8 ----- bdr 4:1R RECEIVE PROCESSOR ----- Band Int_Redn Ext_Redn Switch RF_Out_A ▲ ▼ </pre>	<pre> CONF I G ----- Shelf 0 Slot 8 ----- bdr 4:1R RECEIVE PROCESSOR ----- RF_Out_B RF_Out_C RF_Out_D RFA_Attn RFB_Attn ▲ ▼ </pre>	<pre> CONF I G ----- Shelf 0 Slot 8 ----- bdr 4:1R RECEIVE PROCESSOR ----- RFC_Attn RFD_Attn FER_Rst </pre>	<pre> CONF I G ----- Shelf 0 Slot 8 ----- bdr 4:1R RECEIVE PROCESSOR ----- Band 7 - 42MHz </pre>
<pre> CONF I G ----- Shelf 0 Slot 8 ----- bdr 4:1R RECEIVE PROCESSOR ----- Int_Redn Yes </pre>	<pre> CONF I G ----- Shelf 0 Slot 8 ----- bdr 4:1R RECEIVE PROCESSOR ----- Ext_Redn No </pre>	<pre> CONF I G ----- Shelf 0 Slot 8 ----- bdr 4:1R RECEIVE PROCESSOR ----- Switch Deflt_1 </pre>	<pre> CONF I G ----- Shelf 0 Slot 8 ----- bdr 4:1R RECEIVE PROCESSOR ----- RF_Out_A Auto </pre>

Configuring the bdr 4:1 Receive Processor Using the ICIM, Continued

CONF I G ----- Shelf 0 Slot 8 ----- bdr 4:1R RECEIVE PROCESSOR ----- RF_Out_B Auto	CONF I G ----- Shelf 0 Slot 8 ----- bdr 4:1R RECEIVE PROCESSOR ----- RF_Out_C Auto	CONF I G ----- Shelf 0 Slot 8 ----- bdr 4:1R RECEIVE PROCESSOR ----- RF_Out_D Auto	CONF I G ----- Shelf 0 Slot 8 ----- bdr 4:1R RECEIVE PROCESSOR ----- RFA_Attn 0 dB
CONF I G ----- Shelf 0 Slot 8 ----- bdr 4:1R RECEIVE PROCESSOR ----- RFB_Attn 0 dB	CONF I G ----- Shelf 0 Slot 8 ----- bdr 4:1R RECEIVE PROCESSOR ----- RFC_Attn 0 dB	CONF I G ----- Shelf 0 Slot 8 ----- bdr 4:1R RECEIVE PROCESSOR ----- RFD_Attn 0 dB	CONF I G ----- Shelf 0 Slot 8 ----- bdr 4:1R RECEIVE PROCESSOR ----- FER_Rst Count

Checking bdr 4:1 Receive Processor Alarms Using the ICIM

Alarm Data Display

The alarms generated by this module are shown below.

Alarm	Alarm Condition	Indication	Possible Cause
FPGA	FPGA operation	Fault	Indicates the internal FPGA has stopped working. Unit needs repair.
ASIC	ASIC configuration	Fault	ASIC tables failed to load or loss of communications with ASIC. Reseat module.
Power_In	Power supply indicates a fault	Fault	Check power cord. Make sure power supply is fully seated.
+1_8VInt	Internal 1.8 Voltage	Fault	Check power supply module(s).
+3_3VInt	Internal 3.3 Voltage	Fault	Check power supply module(s).
ProcTemp	Module Temperature	Fault	Check fan tray operation.
OSM_Comm	Cannot communicate with the optical receiver	Fault	Cannot communicate with the optical receiver. Reseat or replace the receiver.
Rcv1Pres	Optical receiver 1 not present	Fault	Optical receiver 1 not present.
Rcv2Pres	Optical receiver 2 not present	Fault	Optical receiver 2 not present.
Rcv1_LOS	Optical receiver 1 loss of signal	Fault	Check fiber line and data into optical receiver 1.
Rcv2_LOS	Optical receiver 2 loss of signal	Fault	Check fiber line and data into optical receiver 2.
APDBias1	APD1 bias incorrect	Fault	Re-seat optical receiver 1. Replace if necessary.
APDBias2	APD2 bias incorrect	Fault	Re-seat optical receiver 2. Replace if necessary.
Framing	The signal cannot be framed	Fault	Check fiber connection path and bdr transmitter.
Clock100	Internal clock generator	Fault	Unit needs repair.

Checking bdr 4:1 Receive Processor Alarms Using the ICIM, Continued













Checking Alarms

If the red ALARM LED on the front panel is blinking a minor alarm condition is indicated. If the red ALARM LED on the front panel is illuminated, a critical alarm condition is indicated.

Alarms fall into one of the following categories.

- Major low
- Minor low
- Minor high
- Major high

To check alarm conditions follow these steps.

1. From the MAIN menu, press the  key to highlight the **Shelf** and **Slot** fields.
2. Press the  key to address the **Shelf** number. Then press the  key or the  keys to scroll to the number of the desired shelf.
3. Press the  key. The **Slot** field is highlighted.
4. Press the  key or the  key to scroll to the number of the desired slot.
5. Press the  key. The **MODULE** menu is displayed on the ICIM.
6. Press the  key. The module alarm conditions are displayed here.
7. Use the  key or the  key to scroll through alarm conditions until the desired alarm is displayed.
8. Monitor the alarm condition(s). Take appropriate action. Verify that all settings and thresholds relating to the alarm indication are set correctly to rule out an unintended alarm.
9. When finished, press the  key. The display returns to the MAIN menu.

Checking bdr 4:1 Receive Processor Alarms Using the ICIM, Continued

Alarm Thresholds

Alarm thresholds are shown below. Alarm thresholds are not adjustable on this module.

Alarm	Function	Major Low Thhold	Minor Low Thhold	Minor High Thhold	Major High Thhold	Unit	Typical range
+1_8VInt	Internal 1.8 voltage	1.620	1.67	1.93	1.980	V DC	1.77 – 1.83
+3_3VInt	Internal 3.3 voltage	2.970	3.070	3.530	3.630	V DC	3.2 – 3.4
ProcTemp	Module temperature	-40	-30	80	85	°C	40-50

Checking bdr 4:1 Receive Processor Alarms Using the ICIM, Continued

bdr Receive Processor ALARM Menus

When a module's **ALARM** menu is selected, press the  key or the  key to scroll through alarms. Some typical **ALARMS** menus are shown below.

<pre>ALARMS ----- Shelf 0 Slot 8 ----- bdr 4:1 RECEIVE PROCESSOR ----- FPGA Fault ----- ▲ ▼</pre>	<pre>ALARMS ----- Shelf 0 Slot 8 ----- bdr 4:1 RECEIVE PROCESSOR ----- ASIC Fault ----- ▲ ▼</pre>	<pre>ALARMS ----- Shelf 0 Slot 8 ----- bdr 4:1 RECEIVE PROCESSOR ----- Power_In Fault ----- ▲ ▼</pre>	<pre>ALARMS ----- Shelf 0 Slot 8 ----- bdr 4:1 RECEIVE PROCESSOR ----- +1_8 VInt Fault ----- ▲ ▼</pre>
<pre>ALARMS ----- Shelf 0 Slot 8 ----- bdr 4:1 RECEIVE PROCESSOR ----- +3_3 VInt Fault ----- ▲ ▼</pre>	<pre>ALARMS ----- Shelf 0 Slot 8 ----- bdr 4:1 RECEIVE PROCESSOR ----- ProcTemp Fault ----- ▲ ▼</pre>	<pre>ALARMS ----- Shelf 0 Slot 8 ----- bdr 4:1 RECEIVE PROCESSOR ----- OSM_Comm Fault ----- ▲ ▼</pre>	<pre>ALARMS ----- Shelf 0 Slot 8 ----- bdr 4:1 RECEIVE PROCESSOR ----- Rcv1Pres Fault ----- ▲ ▼</pre>

Checking bdr 4:1 Receive Processor Alarms Using the ICIM, Continued

ALARMS	
Shelf	0
Slot	8

bdr 4:1R RECEIVE PROCESSOR	

Rcv2Pres Fault	

▲ ▼	

ALARMS	
Shelf	0
Slot	8

bdr 4:1R RECEIVE PROCESSOR	

Rcv1_LOS Fault	

▲ ▼	

ALARMS	
Shelf	0
Slot	8

bdr 4:1R RECEIVE PROCESSOR	

Rcv2_LOS Fault	

▲ ▼	

ALARMS	
Shelf	0
Slot	8

bdr 4:1R RECEIVE PROCESSOR	

APDBias1 Fault	

▲ ▼	

ALARMS	
Shelf	0
Slot	8

bdr 4:1R RECEIVE PROCESSOR	

APDBias2 Fault	

▲ ▼	

ALARMS	
Shelf	0
Slot	8

bdr 4:1R RECEIVE PROCESSOR	

Framing Fault	

▲ ▼	

ALARMS	
Shelf	0
Slot	8

bdr 4:1R RECEIVE PROCESSOR	

Clock100 Fault	

▲ ▼	

Checking Manufacturing Data Using the ICIM

Manufacturing Data Display









The table below describes the manufacturing data available for this module.

Manufacturing Data	Explanation
Module Type	Cisco module type number.
Serial #	The alphanumeric device serial number.
Date Code	Code describing year and month of module manufacture.
Sw Ver (Software Version)	Core code software version.
Script Ver (Script Version)	Module software script version.
In Service Hours	Number of hours that the module has been used.
Spec Data	No special data for this module.
Restore Factory Defaults	Restores all factory default configuration settings.



Checking Manufacturing Data Using the ICIM, Continued

Checking Manufacturing Data

The manufacturing data (**MFG. DATA**) information listed above may be displayed on the ICIM menu. To access the module's manufacturing data, follow these steps.



1. From the MAIN menu, press the  key to highlight the **Shelf** and **Slot** fields.
2. Press the  key to address the **Shelf** number. Then press the  key or the  keys to scroll to the number of the desired shelf.
3. Press the  key. The **Slot** field is highlighted.
4. Press the  key or the  key to scroll to the number of the desired slot.
5. Press the  key. The MODULE menu for this module will be selected, as shown on the left below. Press the  key to enter the start of the manufacturing data screens, as shown on the right below.

MODULE	MFG. DATA
-----	-----
Shelf 0	Shelf 0
Slot 8	Slot 8
-----	-----
bdr 4:1R	bdr 4:1R
RECEIVE	RECEIVE
PROCESSOR	PROCESSOR
-----	-----
Alarms	Module
1	Type
-----	-----
Mfg. Data	2008
▲ ▼	▲ ▼

6. The  or  key allows you to scroll through the manufacturing data.

Checking Manufacturing Data Using the ICIM, Continued

MFG. DATA Menus

When the **MFG. DATA** menu is selected, the  key or the  key allows you to scroll through the manufacturing parameters specific to this module. Typical **MFG. DATA** menus are shown below.

MFG. DATA	
Shelf	0
Slot	8

bdr 2:1R	
RECEIVE	
PROCESSOR	

Module	
Type	
2008	
▲ ▼	

MFG. DATA	
Shelf	0
Slot	8

bdr 2:1R	
RECEIVE	
PROCESSOR	

Serial #	
!AAYCUAZ	
Date Code	
F00	
▲ ▼	

MFG. DATA	
Shelf	0
Slot	8

bdr 2:1R	
RECEIVE	
PROCESSOR	

SW Ver	
NCCB111	
Script Ver	
6	
▲ ▼	

MFG. DATA	
Shelf	0
Slot	8

bdr 2:1R	
RECEIVE	
PROCESSOR	

In Service	
Hours	
10	
▲ ▼	

MFG. DATA	
Shelf	0
Slot	8

bdr 4:1R	
RECEIVE	
PROCESSOR	

Spec Data	
Prisma II	
▲ ▼	

MFG. DATA	
Shelf	0
Slot	8

bdr 4:1R	
RECEIVE	
PROCESSOR	

Restore	
Factory	
Defaults	

Using the ICIM to Save the Configuration

Saving the Current Configuration

To save the current module configuration, follow these steps after every change.

1. After you have changed a parameter or entered data, press the **ENTER** key to save the changes and return to the MAIN menu.
2. If you do not save your changes for two minutes, or if you press the **SHIFT** **CAN** keys at the same time, changes are aborted and the display returns to the MAIN menu.

Configuration Complete

Once you have configured this module to your system's specifications using the ICIM and no alarms are indicated, no further action is necessary. The module operates without further input. Alarms, changes in operating parameters, electrical power fluctuations, or changes in system design may be cause for additional action.

Chapter 4

Operation Using the LCI Software

Overview

Introduction

The procedures in this chapter apply if you are using the Local Craft Interface (LCI) software to configure and operate the Prisma II bdr 4:1 Redundant Receive Processor.

Scope of This Chapter

Included in this chapter are LCI software installation instructions and detailed descriptions of how to use the LCI software to view and modify information for the receive processor.

In This Chapter

This chapter contains the following topics.

Topic	See Page
LCI Introduction	4-3
System Requirements	4-4
Obtaining and Installing the Prisma II Driver Upgrade	4-5
Installing LCI	4-6
Connecting Your Computer to the Chassis	4-10
Starting LCI	4-11
LCI Device Tree Overview	4-13
Accessing the Device Details Window	4-14

Overview, Continued

Topic	See Page
Checking the Operating Status	4-17
Configuring the bdr Receive Processor	4-19
Checking bdr Receive Processor Alarms	4-22
Checking Device Properties	4-24



WARNING:

Avoid damage to your eyes! Do not look into any optical connector while the system is active. Even if the unit is off, there may still be hazardous optical levels present.

LCI Introduction

The LCI Software Function

The LCI software functions as a user interface for the Prisma II platform. The LCI software is installed on a PC computer, which is then connected to a Prisma II Chassis. Using the LCI software, you can configure and monitor the modules in the chassis the computer is connected to.

Important: Do not operate any Prisma II Chassis without a Fan Tray installed. If a Fan Tray is not installed in the Prisma II Chassis, the LCI software will not communicate with the power supplies in that chassis.

System Requirements

Introduction

You will need the following computer software and hardware to run the LCI software. Typically a laptop PC is used for portability.

Computer Requirements

- Pentium II 300 MHz processor or equivalent
- 128 MB RAM
- 10 MB available hard drive space
- 1.44 MB floppy drive
- CD-ROM Drive
- Windows 98 or Windows NT

Connecting the PC to the Prisma II Chassis

The required cable is a standard “off the shelf” DB9 Female to DB9 Male serial extension cable. The connectors are a serial 9-pin D-shell (EIA 574/232).

The Cisco part number for a six-foot DB9 Female to DB9 Male extension cable is 180143.

Obtaining and Installing the Prisma II Driver Upgrade

Required Software

To operate the Prisma II bdr 4:1 Redundant Transmit Processor and the Prisma II bdr 4:1 Redundant Receive Processor using the LCI software, you must have (in addition to Windows) the following Cisco software installed on your PC.

- LCI software version 1.4.3 or later
- Prisma II Driver Upgrade if using LCI version 1.4.3.

Important: If you are using LCI software version 1.4.3, it must be installed on your PC prior to installing the Prisma II Driver Upgrade. LCI software version 1.4.3 was shipped on CD-ROM with the 56-connector chassis and is also available at the web site shown below.

This upgrade is *not* required to operate the Prisma II bdr 4:1 Redundant Transmit and Receive Processors if you are using the Prisma II ICIM or any LCI software later than 1.4.3.

Downloading the Prisma II Driver Upgrade

To obtain the Prisma II Driver Upgrade, you must download the upgrade from the internet. The URL is:

<http://www.scientificatlanta.com/tncs/upgrades/upgrades.htm>

Internet access is required in order to obtain this software. Downloads may be made to any computer but must ultimately be installed on the PC running the LCI software.

Saving and Installing the Prisma II Driver Upgrade (LCI Software Version 1.4.3 ONLY)

To install this upgrade, follow the instructions below.

1. Ensure that LCI software version 1.4.3 is installed on your system. If not, install it before proceeding.
2. Access the web site shown above.
3. Click the **Prisma II Driver Upgrade** link.
4. At the prompt, save the file to a location of your choice on your system.
5. In Windows Explorer, double-click the saved file.
6. Follow the prompts of the install program. The Prisma II Driver Upgrade is installed in the proper location on your system. The LCI software is now ready to use with the Prisma II bdr 4:1 Redundant Transmit and Receive Processors.

Installing LCI

Introduction

This section describes how to install your LCI software.

Installing the LCI Software

To install the LCI software, follow these steps.

1. Close all programs that are running on your computer.
2. Insert the LCI CD-ROM into your CD-ROM drive.

Result: The LCI software installation program starts automatically. If the installation program does not start automatically, open Windows Explorer and double-click the file **setup.exe** on the LCI CD-ROM.

3. The Welcome screen opens. Click **Next**.

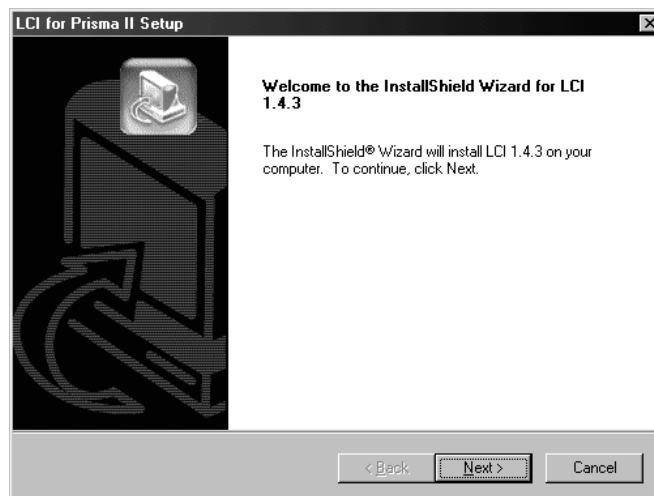

Result: The License Agreement screen opens.

Installing LCI, Continued

4. Click **Yes** to accept the license agreement.

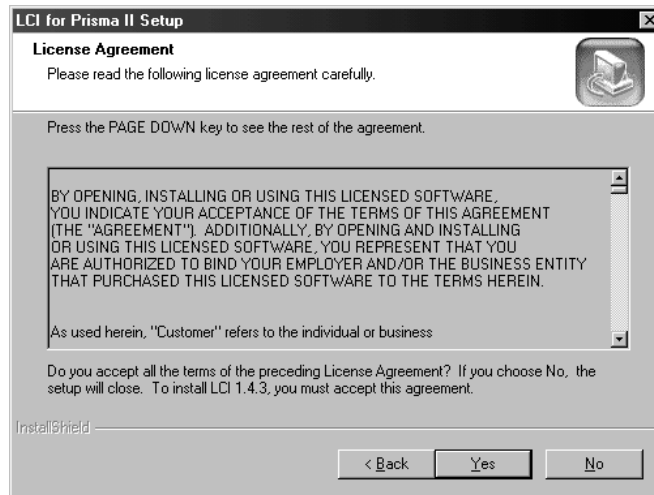

Result: The License Agreement Confirmation dialog box opens.

5. Click **Yes**.

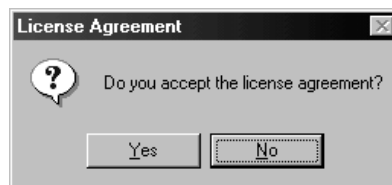

Result: The Destination Folder screen opens.

Installing LCI, Continued

6. Do you want to install the LCI software in the specified **Destination Folder**?
 - If **yes**, click **Next** to begin the installation, and go to step 10.
 - If **no**, go to step 7.

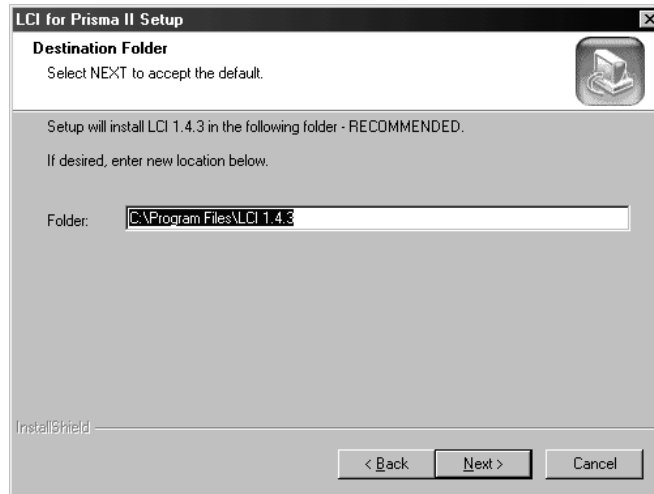

7. To specify where you want the LCI software to be installed, type the path in the text box of the **Folder:** field.
8. Click **Next** to begin the installation.

Result: The last installation wizard screen opens after the installation is complete.

Installing LCI, Continued

9. Before you can use the LCI software, you must restart your computer. Choose whether to restart your computer now or later by selecting the appropriate option button.



10. Click **Finish**. After your computer is restarted, you can use the LCI software.

Important: If using LCI version 1.4.3 or earlier to operate the Prisma II bdr 4:1 Redundant Transmit or Prisma II bdr 4:1 Redundant Receive Processors, you must have the Prisma II Driver Upgrade installed on your PC. See **Obtaining and Installing the Prisma II Driver Upgrade** earlier in this chapter.

Connecting Your Computer to the Chassis

Introduction

Before you start the LCI software, you must first connect your computer to the chassis that contains the module(s) you want to check.

Important: The LCI software communicates only with those modules located in the chassis your computer is attached to. To check other modules, you must connect your computer to the chassis they are located in.

Connecting to the Chassis

To connect your PC to the chassis, follow these steps.

1. Plug the female end of a 9-pin serial extension cable into your computer.
2. Plug the male end of the cable into the LCI port. This port is labeled “Local Craft Interface”.

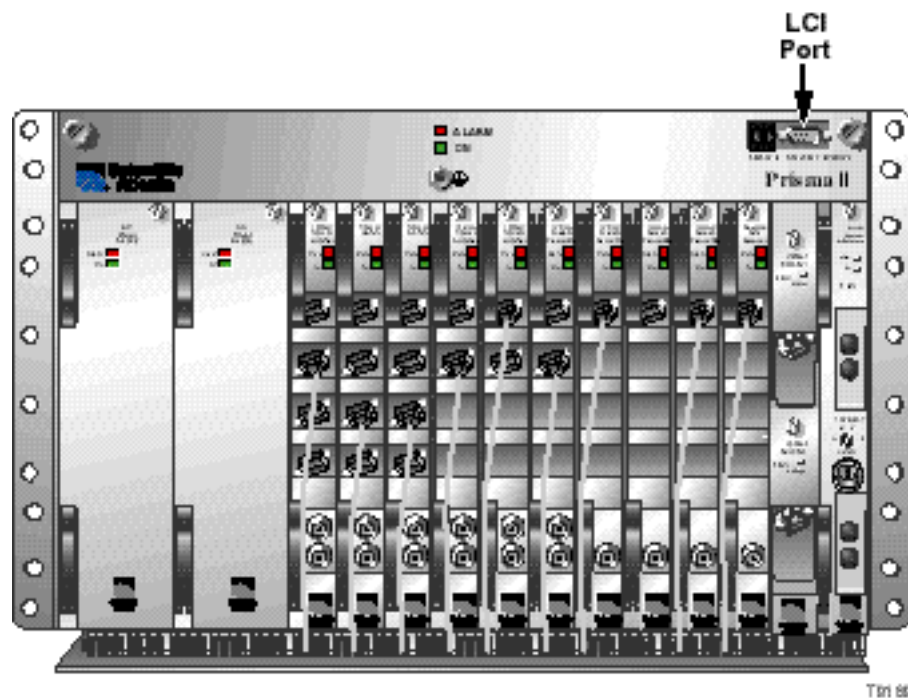

Starting LCI

Introduction

When you start the LCI software, it queries the devices (modules) located in the chassis that is connected to your computer. After this query process (referred to as the learn mode), the LCI software does the following for each device it finds.

- Represents the device in the device tree of the main LCI window.
- Makes the polling information available so you can check and configure various parameters.

Important: Your computer must be connected to the chassis before you start the LCI software. For instructions, refer to **Connecting Your Computer to the Chassis** earlier in this chapter.

Starting the LCI Software

To start the software, perform these steps.

1. Double-click the LCI icon on your Windows desktop.



Result: The LCI Main window opens and the LCI Detect Configuration window opens.

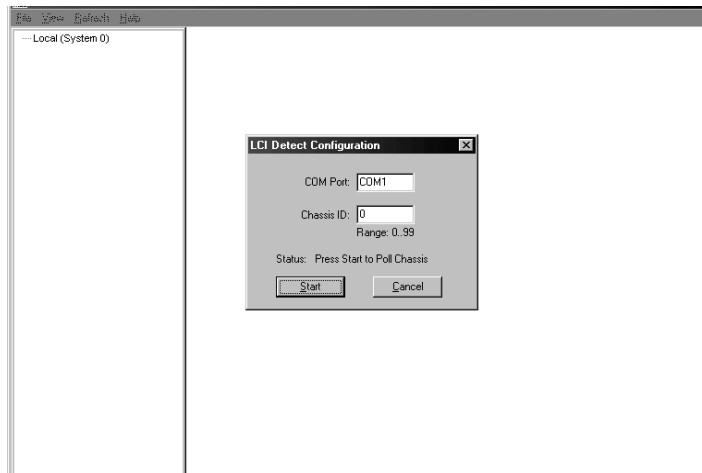

2. Verify the communication port displayed in the **Port** box. This is the port on your computer that the chassis is connected to.

To change the com port, type the word “com” and then the port number.

Example: To specify com port 1, type **COM1**.

Starting LCI, Continued

3. Verify that the Chassis ID is the same number that is dialed in on the Chassis ID switch on the front of the Prisma II Chassis which you are connected to.

To change the Chassis ID, type the number in the box.

4. Click **Start**.

Result: The LCI software polls the Prisma II Chassis.

5. When the refresh is complete, click **OK**.

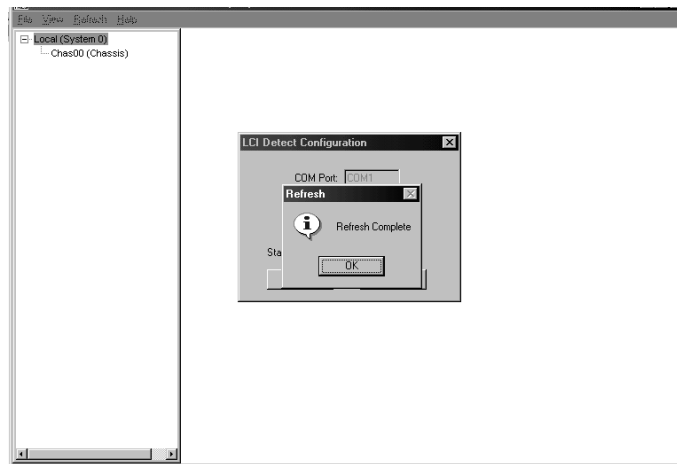

Result: The chassis and modules appear in the device tree of the main window of the LCI software.

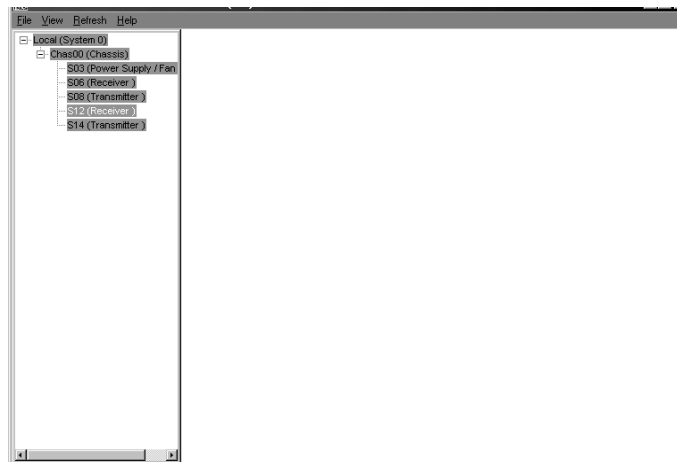

LCI Device Tree Overview

Introduction

The main window of the LCI software contains a tree that represents your system in a hierarchical manner.

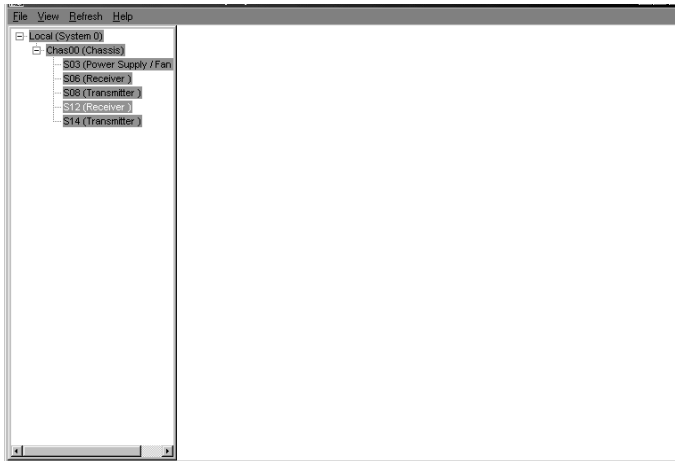

Device Tree

In the graphic above, the device tree represents a PC connected to a chassis that contains five modules. The three tree levels are described in the following table.

Device Tree Level	Description
Local (System 0)	PC computer being used
Chass00 (Chassis)	Chassis the computer is connected to
Sxx (Device name)	Module(s) located within the chassis. Each device is of the format <i>chassis slot location (device name)</i> . Example: In the graphic above, S12 (Receiver) represents a bdr Receive Processor that is located in slot 12 of the chassis.

Accessing the Device Details Window

Introduction

Information about a device (its parameters, alarms, and status) is located in the Device Details window. The illustration below shows the Device Details window for the Prisma II bdr 4:1 Redundant Receive Processor.

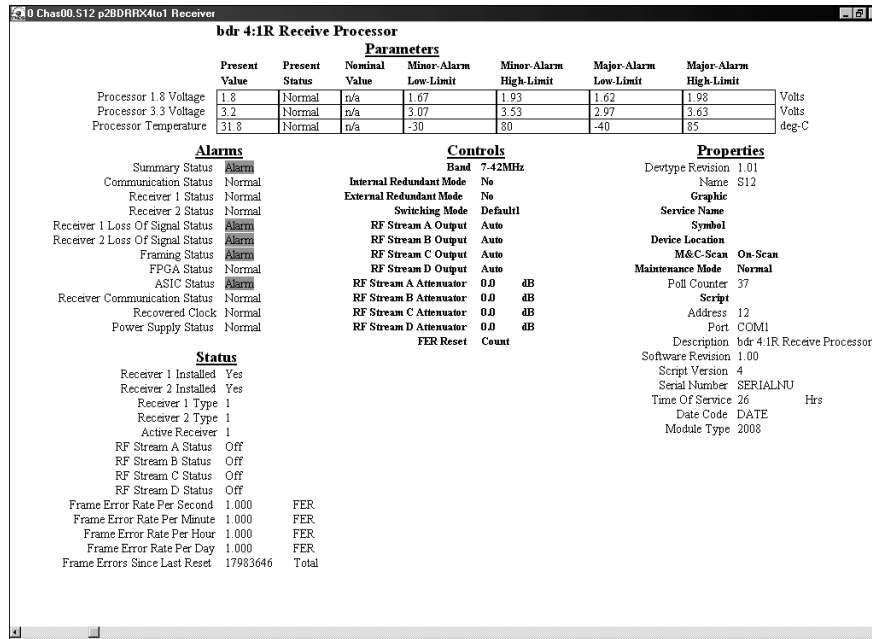

Within the LCI device tree, you can access this window using one of the following four methods:

- Double-click the chassis and select the device in the graphic that displays
- Right-click the chassis and select **Open** from the menu that opens.
- Double-click the module.
- Right-click the device and select **Details** from the menu that opens.

Note: Although you can use the method that is most convenient for you, the procedures throughout this chapter are described using the right-click device technique.

For more information about the device tree, refer to **LCI Device Tree Overview** earlier in this chapter.

Accessing the Device Details Window, Continued

Right-Click the Chassis

To access the Device Details window, perform these steps.

1. Right-click the chassis, and click **Open**.

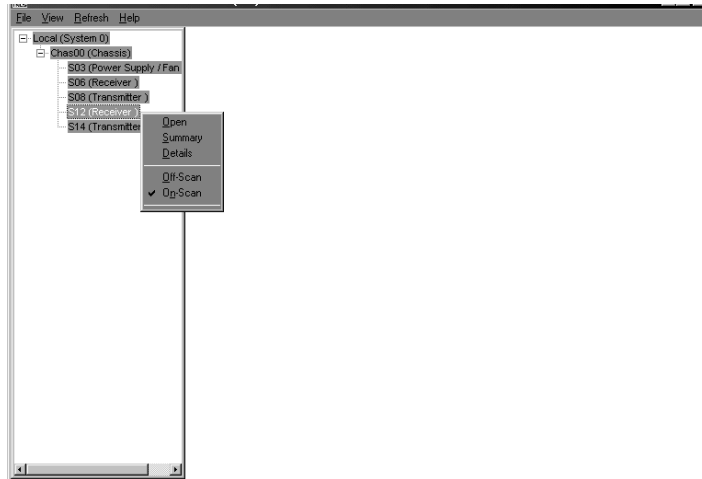

Result: A graphic representation of the chassis opens.

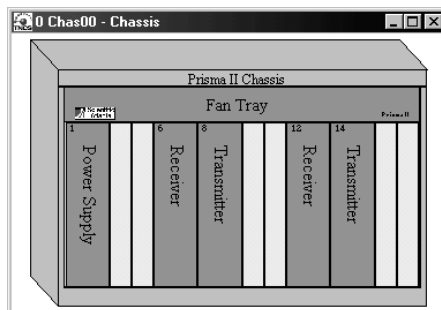

Accessing the Device Details Window, Continued

- Double-click the device whose information you want to view and/or configure.

Result: The Device Details window displays.

Parameters

Present Value	Present Status	Nominal Value	Minor-Alarm Low-Limit	Minor-Alarm High-Limit	Major-Alarm Low-Limit	Major-Alarm High-Limit	
1.8	Normal	n/a	1.67	1.93	1.62	1.98	Volts
3.2	Normal	n/a	3.07	3.53	2.97	3.63	Volts
31.8	Normal	n/a	-30	80	-40	85	deg-C

Alarms

- Summary Status: **Alarm**
- Communication Status: Normal
- Receiver 1 Status: Normal
- Receiver 2 Status: Normal
- Receiver 1 Loss Of Signal Status: **Alarm**
- Receiver 2 Loss Of Signal Status: **Alarm**
- Framing Status: **Alarm**
- FPGA Status: Normal
- ASIC Status: **Alarm**
- Receiver Communication Status: Normal
- Recovered Clock: Normal
- Power Supply Status: Normal

Controls

- Band: 7-42MHz
- Internal Redundant Mode: No
- External Redundant Mode: No
- Switching Mode: Default
- RF Stream A Output: Auto
- RF Stream B Output: Auto
- RF Stream C Output: Auto
- RF Stream D Output: Auto
- RF Stream A Attenuator: 0.0 dB
- RF Stream B Attenuator: 0.0 dB
- RF Stream C Attenuator: 0.0 dB
- RF Stream D Attenuator: 0.0 dB
- FER Reset: Count

Properties

- Devtype Revision: 1.01
- Name: S12
- Graphic:
- Service Name:
- Symbol:
- Device Location:
- M&C-Scan: On-Scan
- Maintenance Mode: Normal
- Poll Counter: 37
- Script:
- Address: 12
- Port: COM1
- Description: bdr 4:1R Receive Processor
- Software Revision: 1.00
- Script Version: 4
- Serial Number: SERIALNU
- Time Of Service: 26 Hrs
- Date Code: DATE
- Module Type: 2008

Status

- Receiver 1 Installed: Yes
- Receiver 2 Installed: Yes
- Receiver 1 Type: 1
- Receiver 2 Type: 1
- Active Receiver: 1
- RF Stream A Status: Off
- RF Stream B Status: Off
- RF Stream C Status: Off
- RF Stream D Status: Off
- Frame Error Rate Per Second: 1.000 FER
- Frame Error Rate Per Minute: 1.000 FER
- Frame Error Rate Per Hour: 1.000 FER
- Frame Error Rate Per Day: 1.000 FER
- Frame Errors Since Last Reset: 17983646 Total

- Proceed with viewing and/or configuring information.

Checking the Operating Status

Introduction

Using the LCI software, you can check the status of all operating parameters of the Prisma II bdr 4:1 Redundant Receive Processor.

Monitored Parameters

Monitored parameters for the processor, using the LCI software are shown below.

Parameter	Units	Function
Module 1.8 Voltage	V DC	Internal voltage level-nominal 1.8 V
Module 3.3 Voltage	V DC	Internal voltage level-nominal 3.3 V
Module Temperature	°C	Indicates processor temperature.
Receiver 1 Installed Receiver 2 Installed	Yes or No	Indicates if receivers are installed.
Optical Receiver 1 Type Optical Receiver 2 Type	1 or 2	Indicates the type receiver that is installed. 1 = standard range receiver - PIN 2 = extended range receiver - APD
Active Receiver	1 or 2	Indicates which receiver is in use.
RF Stream A Status RF Stream B Status RF Stream C Status RF Stream D Status	Auto, On or Off	Indicates the output status for the RF channels.
Frame Error Rate per Second Frame Error Rate per Minute Frame Error Rate per Hour Frame Error Rate per Day	Number	Indicates the frame error rate for the last second, minute, hour, or day.
Frame Error Rate since last Reset	Number	Indicates the frame error rate since the last reset.

Checking the Operating Status, Continued

Checking the Operating Status

To monitor the Prisma II bdr 4:1 Redundant Receive Processor operating parameters, follow these steps.

1. Access the Device Details window. The monitored parameters are displayed under **Parameters** and **Status**.

bdr 4:1R Receive Processor

Parameters								
Present Value	Present Status	Nominal Value	Minor Alarm Low-Limit	Minor Alarm High-Limit	Major Alarm Low-Limit	Major Alarm High-Limit		
Processor 1.8 Voltage	1.8	Normal	n/a	1.67	1.93	1.98	Volts	
Processor 3.3 Voltage	3.2	Normal	n/a	3.07	3.53	2.97	3.63	Volts
Processor Temperature	31.8	Normal	n/a	-30	80	-40	85	deg-C

Alarms

- Summary Status: **Alarm**
- Communication Status: Normal
- Receiver 1 Status: Normal
- Receiver 2 Status: Normal
- Receiver 1 Loss Of Signal Status: **Alarm**
- Receiver 2 Loss Of Signal Status: **Alarm**
- Framing Status: **Alarm**
- FPGA Status: Normal
- ASIC Status: **Alarm**
- Receiver Communication Status: Normal
- Recovered Clock: Normal
- Power Supply Status: Normal

Controls

- Band: 7.42MHz
- Internal Redundant Mode: No
- External Redundant Mode: No
- Switching Mode: Default
- RF Stream A Output: Auto
- RF Stream B Output: Auto
- RF Stream C Output: Auto
- RF Stream D Output: Auto
- RF Stream A Attenuator: 0.0 dB
- RF Stream B Attenuator: 0.0 dB
- RF Stream C Attenuator: 0.0 dB
- RF Stream D Attenuator: 0.0 dB
- FER Reset: Count

Properties

- Devtype Revision: 1.01
- Name: S12
- Graphic: **Graphic**
- Service Name: **Service Name**
- Symbol: **Symbol**
- Device Location: **Device Location**
- M&C-Scan: On Scan
- Maintenance Mode: Normal
- Poll Counter: 37
- Script: **Script**
- Address: 12
- Port: COM1
- Description: bdr 4:1R Receive Processor
- Software Revision: 1.00
- Script Version: 4
- Serial Number: SERIALNU
- Time Of Service: 26 Hrs
- Date Code: DATE
- Module Type: 2008

Status

- Receiver 1 Installed: Yes
- Receiver 2 Installed: Yes
- Receiver 1 Type: 1
- Receiver 2 Type: 1
- Active Receiver: 1
- RF Stream A Status: Off
- RF Stream B Status: Off
- RF Stream C Status: Off
- RF Stream D Status: Off
- Frame Error Rate Per Second: 1.000 FER
- Frame Error Rate Per Minute: 1.000 FER
- Frame Error Rate Per Hour: 1.000 FER
- Frame Error Rate Per Day: 1.000 FER
- Frame Errors Since Last Reset: 17983646 Total

2. Proceed with checking the operating parameters.

Configuring the bdr Receive Processor

Introduction

Using the LCI software, you can configure several parameters of the Prisma II bdr 4:1 Redundant Receive Processor.

Configurable Parameters

Configurable parameters for the processor are listed below.

Parameter	Function	Values	Default
Band	Band selection for the ASIC.	5-40 MHz or 7-42 MHz or 10-45 MHz	7-42 MHz
Internal Redundant Mode	Internal Redundant mode. When set to Yes , the processor will generate an alarm if either optical receiver is removed. When set to No , it will not generate an alarm unless both optical receivers are removed.	Yes or No	Yes
External Redundant Mode	External Redundancy Mode. If Yes , the processor acts as a backup unit to another processor until an external line indicates the other processor has failed.	Yes or No	No
Switching Mode	Determines how the channels are switched. Deflt_1 and Deflt_2 will select which is the default receiver. Force_1 and Force_2 will force a switch to either optical receiver 1 or optical receiver 2, regardless of any errors.	Deflt_1 Deflt_2 Force_1 Force_2	Deflt_1
RF Stream A Output RF Stream B Output RF Stream C Output RF Stream D Output	Controls the muting of each RF channel. If Auto , the processor determines whether the RF output should be muted (based on alarms such as missing receiver or loss of signal). If On , the output is not muted. If Off , the output is muted.	Auto, On, Off	Auto

Configuring the bdr Receive Processor, Continued

Parameter	Function	Values	Default
RF Stream A Attenuator RF Stream B Attenuator RF Stream C Attenuator RF Stream D Attenuator	Attenuates the RF output of channels A, B, C, and D.	-6 dB to +6 dB in 0.1 dB steps	0 dB
FER Reset	Frame error reset. If Count , the processor continuously counts all frame errors since last reset. If Reset , the processor restarts the frame error count.	Count or Reset	Count

Important: After using the **Reset** function (FER Reset), the frame error rate counter must be returned to the **Count** configuration in order to enable the frame error rate counter. If left in **Reset**, the counter will be in a continuous reset mode and will not display a frame error rate.

Configuring the bdr Receive Processor, Continued Continued

Configuring Parameters

To configure the parameters, follow these steps.

1. Access the Device Details window.

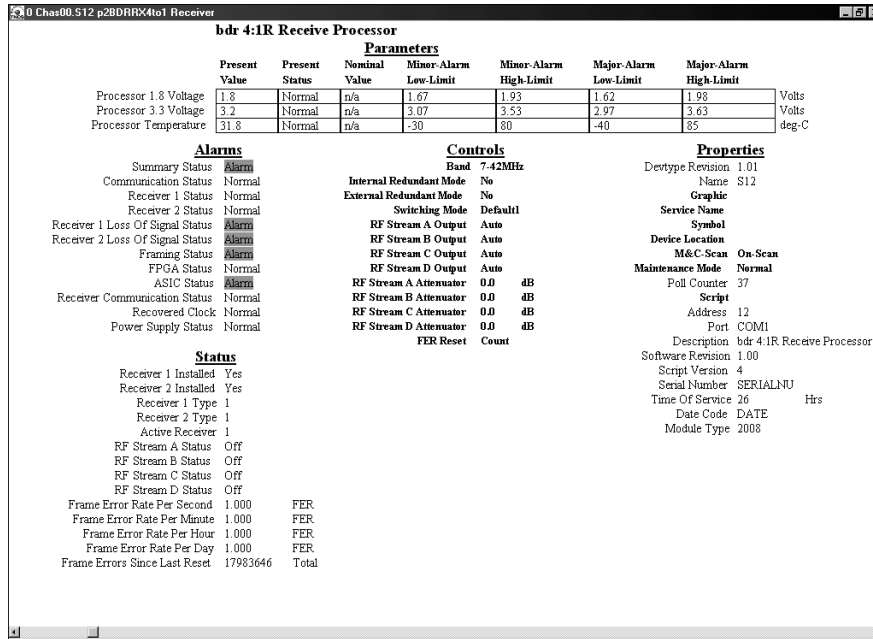

2. Under **Controls**, double-click the parameter you want to configure.

Result: The Change Value dialog box displays. The graphic below shows the dialog box for the Internal Redundant Mode parameter of the bdr 4:1 Redundant Receive Processor.

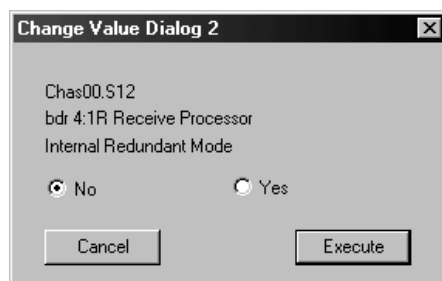

3. Depending on the parameter you chose, select or type a new value.
4. Click **Execute**.

Result: The new value displays next to the parameter.

Checking bdr Receive Processor Alarms

Alarm Conditions

Using LCI, you can check the alarm status of operational parameters. Alarms that you can check are listed below.

Alarm	Alarm Condition	Indication	Possible Cause
Summary Status	Indicates if any parameter is in alarm	Alarm	Dependant on specific alarm.
Communication Status	Processor not communicating with the receiver	Alarm	Reseat or replace the processor.
Optical Receiver 1 Status	Optical receiver 1 not installed	Alarm	Optical receiver 1 not installed
Optical Receiver 2 Status	Optical receiver 1 not installed	Alarm	Optical receiver 1 not installed
Optical Receiver 1 Loss of Signal Status	Optical receiver 1 loss of signal	Alarm	Check fiber line and data into optical receiver 1.
Optical Receiver 2 Loss of Signal Status	Optical receiver 2 loss of signal	Alarm	Check fiber line and data into optical receiver 2.
Framing Status	The signal cannot be framed	Alarm	Check fiber connection path and bdr transmitter.
FPGA Status	FPGA operation	Alarm	Indicates the internal FPGA has stopped working. Unit needs repair.
ASIC Status	ASIC configuration	Alarm	ASIC tables failed to load or loss of communications with ASIC. Reseat processor.
Receiver Communication Status	Cannot communicate with the optical receivers	Alarm	Cannot communicate with the optical receivers. Reseat or replace the receivers.
Recovered Clock	Internal clock generator	Alarm	Unit needs repair.
Power_In	Power supply indicates a fault	Alarm	Check power cord. Make sure chassis power supply is fully seated.

Checking bdr Receive Processor Alarms, Continued

Alarm Categories

Alarms fall into one of the following categories.

- Major low
- Minor low
- Minor high
- Major high

Checking Alarms

To check a parameter's alarm status, perform these steps.

1. Access the Device Details window. Device alarms are shown under **Parameters and Alarms**.

The screenshot shows the configuration window for the bdr 4:1R Receive Processor. It is divided into four main sections: Parameters, Alarms, Controls, and Properties.

Parameters Table:

	Present Value	Present Status	Nominal Value	Minor Alarm Low-Limit	Minor Alarm High-Limit	Major Alarm Low-Limit	Major Alarm High-Limit	
Processor 1.8 Voltage	1.8	Normal	n/a	1.67	1.93	1.62	1.98	Volts
Processor 3.3 Voltage	3.2	Normal	n/a	3.07	3.53	2.97	3.63	Volts
Processor Temperature	31.8	Normal	n/a	-30	80	-40	85	deg-C

Alarms Section:

- Summary Status: **Alarm**
- Communication Status: Normal
- Receiver 1 Status: Normal
- Receiver 2 Status: Normal
- Receiver 1 Loss Of Signal Status: **Alarm**
- Receiver 2 Loss Of Signal Status: **Alarm**
- Framing Status: **Alarm**
- FPGA Status: Normal
- ASIC Status: **Alarm**
- Receiver Communication Status: Normal
- Recovered Clock: Normal
- Power Supply Status: Normal

Controls Section:

- Band: 7.42MHz
- Internal Redundant Mode: No
- External Redundant Mode: No
- Switching Mode: Default
- RF Stream A Output: Auto
- RF Stream B Output: Auto
- RF Stream C Output: Auto
- RF Stream D Output: Auto
- RF Stream A Attenuator: 0.0 dB
- RF Stream B Attenuator: 0.0 dB
- RF Stream C Attenuator: 0.0 dB
- RF Stream D Attenuator: 0.0 dB
- FER Reset: Count

Properties Section:

- Devtype Revision: 1.01
- Name: S12
- Graphic: **Graphic**
- Service Name
- Symbol
- Device Location
- M&C-Scan: On-Scan
- Maintenance Mode: Normal
- Poll Counter: 37
- Script
- Address: 12
- Port: COM1
- Description: bdr 4:1R Receive Processor
- Software Revision: 1.00
- Script Version: 4
- Serial Number: SERIALNU
- Time Of Service: 26 Hrs
- Date Code: DATE
- Module Type: 2008

Status Section:

- Receiver 1 Installed: Yes
- Receiver 2 Installed: Yes
- Receiver 1 Type: 1
- Receiver 2 Type: 1
- Active Receiver: 1
- RF Stream A Status: Off
- RF Stream B Status: Off
- RF Stream C Status: Off
- RF Stream D Status: Off
- Frame Error Rate Per Second: 1.000 FER
- Frame Error Rate Per Minute: 1.000 FER
- Frame Error Rate Per Hour: 1.000 FER
- Frame Error Rate Per Day: 1.000 FER
- Frame Errors Since Last Reset: 17983646 Total

Note: Alarm limits are displayed on this module but cannot be set.

2. If any of the parameters are in alarm, take the corrective action you deem necessary.

Checking Device Properties

Introduction

Using the LCI software, you can check the device properties of the processor.

Properties

The table below describes the device properties available for this module.

Properties	Explanation
Description	Description of the device
Software Revision	Core code software revision
Script Version	Module software script version
Serial number	The alphanumeric device serial number
Time of Service	Number of hours that the device has been used
Date Code	Code describing year and month of manufacture
Module Type	Cisco device type number

Checking Device Properties, Continued

Checking Factory Device Properties

To access the processor's manufacturing data, perform these steps.

1. Access the Device Details window. The device properties are displayed under **Properties**.

The screenshot shows a window titled "bdr 4:1R Receive Processor" with the following sections:

Parameters							
Present Value	Present Status	Nominal Value	Minor-Alarm Low-Limit	Minor-Alarm High-Limit	Major-Alarm Low-Limit	Major-Alarm High-Limit	
Processor 1.8 Voltage	1.8	Normal	n/a	1.67	1.93	1.62	1.98
Processor 3.3 Voltage	3.2	Normal	n/a	3.07	3.53	2.97	3.63
Processor Temperature	31.8	Normal	n/a	-30	80	-40	85

Alarms

- Summary Status: Alarm
- Communication Status: Normal
- Receiver 1 Status: Normal
- Receiver 2 Status: Normal
- Receiver 1 Loss Of Signal Status: Alarm
- Receiver 2 Loss Of Signal Status: Alarm
- Framing Status: Alarm
- FPGA Status: Normal
- ASIC Status: Alarm
- Receiver Communication Status: Normal
- Recovered Clock: Normal
- Power Supply Status: Normal

Controls

- Band: 7.42MHz
- Internal Redundant Mode: No
- External Redundant Mode: No
- Switching Mode: Default1
- RF Stream A Output: Auto
- RF Stream B Output: Auto
- RF Stream C Output: Auto
- RF Stream D Output: Auto
- RF Stream A Attenuator: 0.0 dB
- RF Stream B Attenuator: 0.0 dB
- RF Stream C Attenuator: 0.0 dB
- RF Stream D Attenuator: 0.0 dB
- FER Reset: Count

Properties

- Devtype Revision: 1.01
- Name: S12
- Graphic
- Service Name
- Symbol
- Device Location
- M&C-Scan: On-Scan
- Maintenance Mode: Normal
- Poll Counter: 37
- Script
- Address: 12
- Port: COM1
- Description: bdr 4:1R Receive Processor
- Software Revision: 1.00
- Script Version: 4
- Serial Number: SERIALNU
- Time Of Service: 26 Hrs
- Date Code: DATE
- Module Type: 2008

Status

- Receiver 1 Installed: Yes
- Receiver 2 Installed: Yes
- Receiver 1 Type: 1
- Receiver 2 Type: 1
- Active Receiver: 1
- RF Stream A Status: Off
- RF Stream B Status: Off
- RF Stream C Status: Off
- RF Stream D Status: Off
- Frame Error Rate Per Second: 1.000 FER
- Frame Error Rate Per Minute: 1.000 FER
- Frame Error Rate Per Hour: 1.000 FER
- Frame Error Rate Per Day: 1.000 FER
- Frame Errors Since Last Reset: 17983646 Total

2. Proceed with viewing the device **Properties**.

Chapter 5

Maintenance and Troubleshooting

Overview

Introduction

This chapter provides information to assist you in maintaining and troubleshooting the Prisma II bdr 4:1 Redundant Receive Processor.

Qualified Personnel

Only appropriately qualified and trained personnel should attempt to troubleshoot this product.



WARNING:

Allow only qualified personnel to install, operate, maintain, or service this product. Otherwise, personal injury or equipment damage may occur.

In This Chapter

This chapter contains the following topics.

Topic	See Page
Module Maintenance	5-2
General Troubleshooting Information	5-3
Troubleshooting Alarm Conditions	5-4
Troubleshooting LCI	5-6
Cleaning Fiber-Optic Connectors	5-12

Module Maintenance

Maintaining the Prisma II Module

To extend the life of the module and ensure optimal performance, the following maintenance is recommended.

Frequency	Maintenance Required
Weekly	<ul style="list-style-type: none">• Check all parameters and test points.• Record data.• Make repairs and adjustments as needed.
Quarterly	<ul style="list-style-type: none">• Make sure all cables are mated properly.• Inspect cables for stress and chafing.• Make sure all retaining screws are tight.
When needed	Carefully clean the module with a soft cloth that is dampened with mild detergent.

General Troubleshooting Information

Introduction

This troubleshooting information describes the most common alarms and gives typical symptoms, causes, and items to check before consulting Cisco.

Equipment Needed

You may need the following equipment to troubleshoot the chassis.

- Small flat blade screwdriver
- Fiber connector cleaning materials

Additional Assistance

If you need additional assistance, telephone one of our Technical Service Centers or your local sales subsidiary. The Customer Support section in Chapter 6 contains a list of telephone numbers.

Troubleshooting



WARNING:

Avoid electric shock and damage to this product! Do not open the enclosure of this product. There are no user-serviceable parts inside. Refer servicing to qualified service personnel.

Refer to the following section, **Troubleshooting Alarm Conditions**, to identify and correct module faults.

Troubleshooting Alarm Conditions

Alarm Conditions Displayed by the ICIM

The alarms displayed by the ICIM for this module are shown below.

Alarm	Alarm Condition	Indication	Possible Cause
FPGA	FPGA operation	Fault	Indicates the internal FPGA has stopped working. Unit needs repair.
ASIC	ASIC configuration	Fault	ASIC tables failed to load or loss of communications with ASIC. Reseat module.
Power_In	Power supply indicates a fault	Fault	Check power cord. Make sure power supply is fully seated.
+1_8VInt	Internal 1.8 Voltage	Fault	Check power supply module(s).
+3_3VInt	Internal 3.3 Voltage	Fault	Check power supply module(s).
ProcTemp	Module Temperature	Fault	Check fan tray operation.
OSM_Comm	Cannot communicate with the optical receiver	Fault	Cannot communicate with the optical receiver. Reseat or replace the receiver.
Rcv1Pres	Optical receiver 1 not present	Fault	Optical receiver 1 not present.
Rcv2Pres	Optical receiver 2 not present	Fault	Optical receiver 2 not present.
Rcv1_LOS	Optical receiver 1 loss of signal	Fault	Check fiber line and data into optical receiver 1.
Rcv2_LOS	Optical receiver 2 loss of signal	Fault	Check fiber line and data into optical receiver 2.
APDBias1	APD1 bias incorrect	Fault	Re-seat optical receiver 1. Replace if necessary.
APDBias2	APD2 bias incorrect	Fault	Re-seat optical receiver 2. Replace if necessary.
Framing	The signal cannot be framed	Fault	Check fiber connection path and bdr transmitter.
Clock100	Internal clock generator	Fault	Unit needs repair.

Troubleshooting Alarm Conditions, Continued

Alarm Conditions Displayed on the LCI and TNCS Software

Using the LCI or TNCS software, you can check the alarm status of operational parameters. Alarms that you can check are listed below.

Alarm	Alarm Condition	Indication	Possible Cause
Summary Status	Indicates if any parameter is in alarm	Alarm	Dependant on specific alarm.
Communication Status	Processor not communicating with the receiver	Alarm	Reseat or replace the processor.
Optical Receiver 1 Status	Optical receiver 1 not installed	Alarm	Optical receiver 1 not installed
Optical Receiver 2 Status	Optical receiver 1 not installed	Alarm	Optical receiver 1 not installed
Optical Receiver 1 Loss of Signal Status	Optical receiver 1 loss of signal	Alarm	Check fiber line and data into optical receiver 1.
Optical Receiver 2 Loss of Signal Status	Optical receiver 2 loss of signal	Alarm	Check fiber line and data into optical receiver 2.
Framing Status	The signal cannot be framed	Alarm	Check fiber connection path and bdr transmitter.
FPGA Status	FPGA operation	Alarm	Indicates the internal FPGA has stopped working. Unit needs repair.
ASIC Status	ASIC configuration	Alarm	ASIC tables failed to load or loss of communications with ASIC. Reseat processor.
Receiver Communication Status	Cannot communicate with the optical receivers	Alarm	Cannot communicate with the optical receivers. Reseat or replace the receivers.
Recovered Clock	Internal clock generator	Alarm	Unit needs repair.
Power_In	Power supply indicates a fault	Alarm	Check power cord. Make sure power supply is fully seated.

Troubleshooting LCI

Introduction

When you start the LCI software, it queries the modules located in the chassis that is connected to your laptop computer. After this query process (referred to as the Detect Configuration), the LCI software displays the modules in its module tree.

This section describes the steps to take if the chassis and installed devices do not display.

If the Chassis is Not Displayed in the Module Tree

When the Prisma II Chassis is not displayed in the module tree, the LCI screen will appear as shown here:

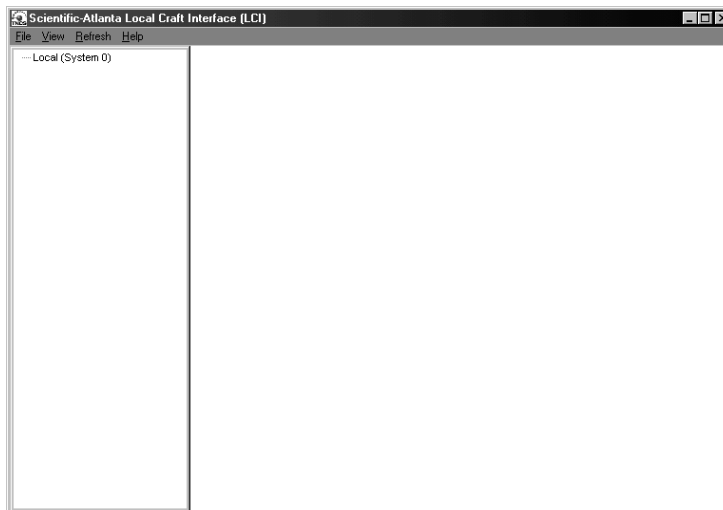

If the chassis is powered-up and properly connected to the PC and the LCI software is operating, and is not displayed in the module tree; the cause may be the result of one of the following two conditions:

- The cable that connects the chassis to your computer is plugged in to a different communications port than the one specified in the LCI Detect Configuration window. See **Specifying the Correct Communications Port** on the following page.
- The Chassis ID number entered in the LCI Detect Configuration window does not agree with the Chassis ID switch located on the front of the Prisma II Chassis. See **Specifying the Correct Chassis ID** on the following page.

Either of the above conditions will result in the LCI software not being able to communicate with the Prisma II Chassis.

Troubleshooting LCI, Continued

Specifying the Correct Communications Port

Follow these steps to specify the correct communications port and chassis ID.

1. In the LCI menu bar, right-click **Local (System0)**. Click **Open** on the sub-menu.

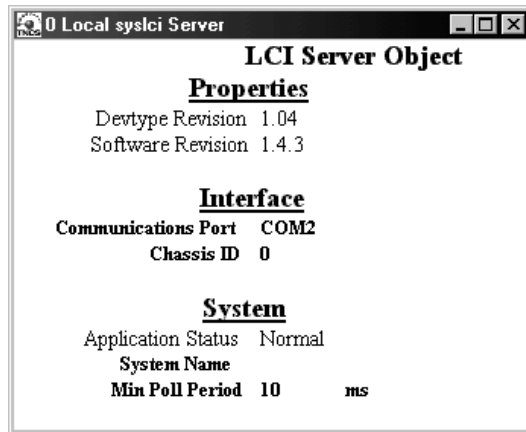

Result: The LCI Server Object window displays.

2. Verify that the **Communications Port** setting is the port on the PC actually used to connect to the Prisma II Chassis.
 - If the correct port is shown, this is not the problem. Proceed to **Specifying the Correct Chassis ID**.
 - If the correct port is not shown, proceed with step 3 of this procedure.

Troubleshooting LCI, Continued

- Under **Interface**, double-click **Communications Port**. In the **COM Port** field, enter the number of the COM Port actually in use connecting the PC to the Prisma II Chassis. **Example:** To specify com port 1, type **COM1**. The designated com port number appears in the **COM Port** field.

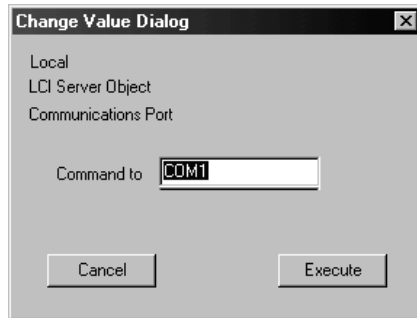

- Click **Execute**.

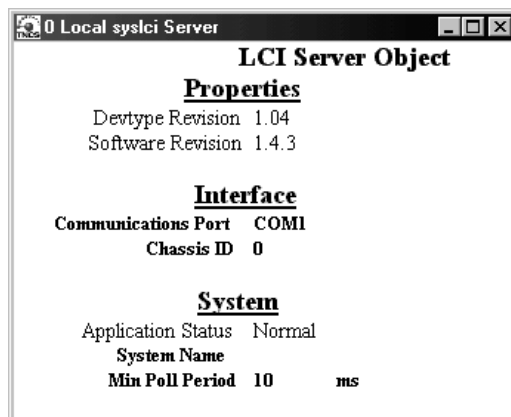

Result: The LCI Server Object window opens showing the correct COM Port.

- In the command bar, click **Refresh**.

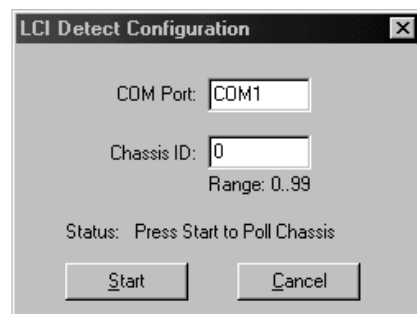

The **LCI Detect Configuration** window opens. Click **Start**.

Troubleshooting LCI, Continued

- The chassis should now display in the module tree as shown below. If not, proceed to **Specifying the Correct Chassis ID** below.

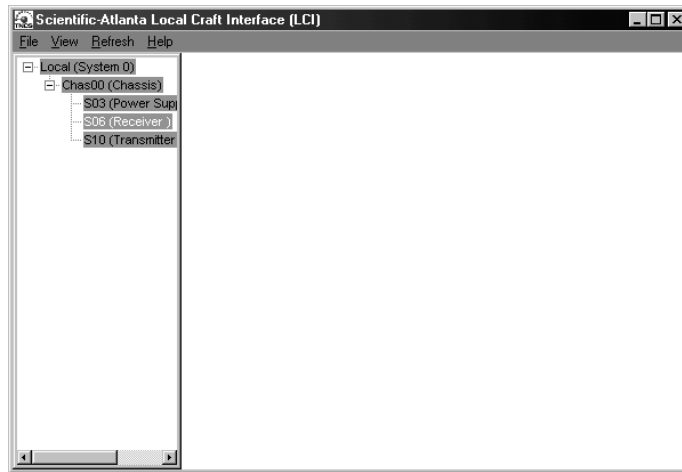

Specifying the Correct Chassis ID

If the Chassis ID number in the LCI Detect Configuration window does not agree with the number set in the Chassis ID switch on the front of the Prisma II Chassis, the software will not recognize the chassis.

In this case, you must change the Chassis ID field in the LCI Detect Configuration window in order for the LCI software to recognize the chassis. Follow these steps to specify the correct Chassis ID number.

- In the LCI menu tree, right-click **Local (System0)**. Click **Open** on the sub-menu.

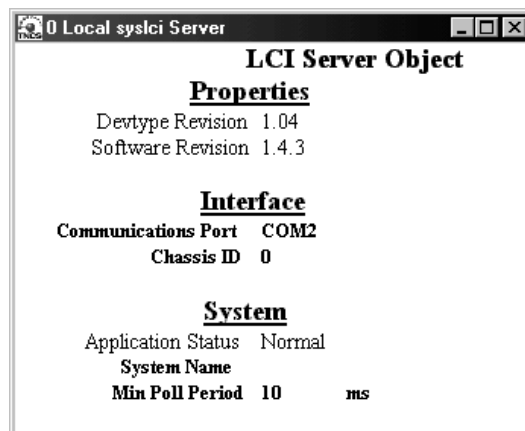

Troubleshooting LCI, Continued

2. Verify that the Chassis ID number matches the number on the Chassis ID switch on the front of the Prisma II Chassis.
 - If the LCI Server Object window shows the same Chassis ID number as the switch, you must re-initiate power to the Prisma II Chassis. See note below.
 - If the software shows a different Chassis ID number is shown, double-click **Chassis ID**, enter the number from the front of the Prisma II Chassis ID switch, then click **Execute**.

Note: If the switch on the front of the Prisma II Chassis was changed after the chassis was powered up, you will have to power-down, then power-up the chassis. However, if an ICIM is installed in the chassis, you can implement the **Update Address** command using the ICIM key. This allows the modules to identify their correct location to the LCI software (and the ICIM). After updating the address using the ICIM, refresh the LCI software by following the steps in the following section.

Not All of the Modules Display in the Module Tree

If some, but not all, of your modules display in the module tree, the cause may be that a device has been added since the software last polled the chassis.

Follow these steps to refresh the display.

1. In the command bar, click **Refresh**.

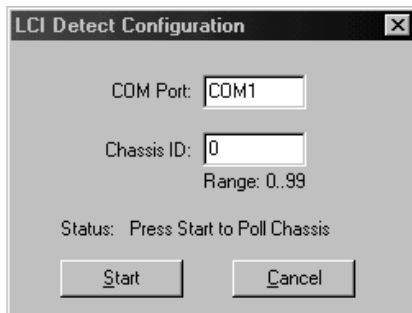

Result: The LCI Detect Configuration window displays.

Troubleshooting LCI, Continued

2. If the **COM Port** and the **Chassis ID** are set correctly, press **Start**. When finished, the Refresh window displays. Click **OK**.



If the **COM Port** or the **Chassis ID** are set incorrectly, follow the previous procedures, **Specifying the Correct Communications Port** and **Specifying the Correct Chassis ID**. Refresh again.

3. Exit LCI and then restart it for all changes to take effect.

Result: All of the installed modules should now display in the module tree.

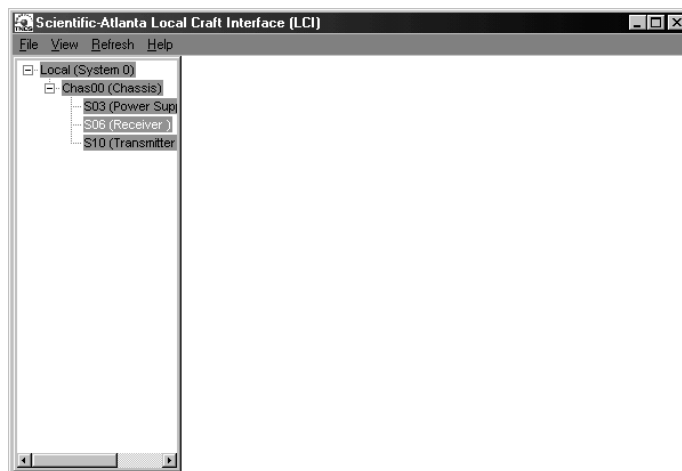

Cleaning Fiber-Optic Connectors

Introduction

Clean fiber-optic connectors can help prevent interconnect problems and therefore aid system performance. When optical connectors are disconnected and reconnected, the fiber surface can become dirty or scratched. The goal of cleaning the fiber optic connectors is to remove all dust and contaminants without leaving any residue behind.

Equipment Needed

You will need the following equipment to clean the ends of fiber optic connectors.

- Optical-grade (91%) isopropyl alcohol
- Lint free wipes
- Compressed air also called “canned air”

Tips for Optimal Fiber-Optic Connector Performance

To ensure optimal connector performance, follow these guidelines.

- Connect or disconnect optical connectors only when necessary
- Always use compressed air before cleaning the fiber optic connectors
- Use end caps on connectors when they are not in use
- Always use compressed air to clean the end caps
- Use optical-grade isopropyl alcohol of at least 91% or greater. Anything less than 91% isopropyl, may leave a film on the fiber surface, creating more problems
- Do not contaminate your alcohol supply. Use a fountain pump, or even better, a sprayer. Do not put used alcohol back into the main container
- Use only lint-free wipes, never use “Kleenex-type” tissues
- If you have any degraded signal problems, clean the fiber optic connector

Cleaning Optical Connectors

To clean the optical connector, follow these steps.

1. Remove loose dirt or dust from the end of the connector by using compressed air (canned air) to blow dirt off the fiber and the connector.
2. Dampen a lint-free wipe with optical-grade (91%) isopropyl alcohol. If no wipes are available, use our ferrule cleaner, part number 468517.
3. Wipe the end of the connector on the lint-free wipe.
4. Inspect the end of the connector for obvious contamination.
5. Mate the connector with an adapter or cover with an end cap.

Chapter 6

Customer Information

Overview

Introduction

If you have technical questions, call Cisco Services for assistance. Follow the menu options to speak with a service engineer.

Access your company's extranet site to view or order additional technical publications. For accessing instructions, contact the representative who handles your account. Check your extranet site often as the information is updated frequently.

Optoelectronic Glossary

Term, Acronym, Abbreviation	Meaning
A	Ampere (amp) is the unit of measure for electrical current.
AC	Alternating current
ADC	Analog to digital converter
Addressable	The ability to control an individual unit in a system of many similar units.
AFC	Automatic Frequency Control
AGC	Automatic Gain Control
AM	Amplitude Modulation
Amplifier Cascade	Two or more amplifiers in a series, the output of one feeding the input of another.
APC	Automatic phase control
APD	Avalanche Photodiode. Avalanche refers to the gain mechanism internal to the photodiode, where 1 photon results in many electrons, as opposed to a PIN photodiode where 1 photon results in 1 electron.
ASIC	Application Specific Integrated Circuit
Attenuation	A decrease in signal magnitude occurring in transmission from one point to another or in passing through a loss medium.
Attenuator	A device designed to reduce signal strength by an amount specified in dB.
ATX	Addressable transmitter
AUX	Auxiliary
Baseband	The total signal before it is modified for transmission or otherwise manipulated.
Baud (Bd)	A measure of signaling rate based on the number of signaling events per unit of time.
Beamwidth	The included angle between two rays (usually the half-power points) on the radiation pattern, which includes the maximum lobe, of an antenna.

Optoelectronic Glossary, Continued

BER	Bit error rate
BERT	Bit error rate test
BIG	Broadband Integrated Gateway
BIOS	Basic Input/Output System
BIST	Built-in self-test
Bit	Short for Binary Digit. Can be either a "one" or a "zero."
Blanking level	The amplitude of the front and back porches of the composite video signal.
BNC	A coaxial connector that uses a bayonet type attachment to secure the cable.
BPF	Bandpass filter
Bps	Bits per second - The total number of bits sent in a second of time.
BPSK	Binary Phase Shift Keying
BW	Bandwidth
Byte	A group of bits treated as a unit
CF	Continuous feed
Circuit switching	The type of signal switching traditionally used by telephone companies to create a physical connection between a caller and a called party.
CIRD	Commercial Integrated Receiver Decoder
CIM	Communications Interface Module
CISC	Complex Instruction Set Computer. A computer that uses many different types of instructions to conduct its operations, i.e., IBM PCs, Apple Macintosh's, IBM 370 mainframes.
CIU	Customer Interface Unit
C/N or CNR	Carrier-to-noise ratio

Optoelectronic Glossary, Continued

Compression	The non-linear change of gain at one level of a signal with respect to the change of gain at another level for the same signal. Also, the elimination of redundant information from an audio, data, or video signal to reduce transmission requirements.
CSO	Composite Second Order
CTB	Composite Triple Beat
C/T	Carrier-to-noise temperature ratio
CW	Continuous Wave
dB	Decibel
dBc	Decibels relative to a reference carrier
DBDS	Digital Broadband Delivery System
dBm	Decibels relative to 1 milliwatt
dBi	Decibels of gain relative to an isotropic radiator
dBuV	Decibels relative to 1 microvolt
dBW	Decibels relative to 1 watt
dBmV	Decibels relative to 1 millivolt
DC	Direct current
DC	Directional coupler
DES	Data Encryption Standard
Deviation	The peak difference between the instantaneous frequency of the modulated wave and the carrier frequency, in an FM system.
DFB	Distributed feed back laser
Differential gain	The difference in amplification of a signal (superimposed on a carrier) between two different levels of carrier.
Diplex filter	A filter which divides the frequency spectrum into a high frequency segment and a low frequency segment so that two different signals can be sent down the same transmission path.

Optoelectronic Glossary, Continued

Distribution System	Part of a cable system consisting of trunk and feeder cables used to carry signals from headend to subscriber terminals.
Downconverter	A device that converts an input signal to a lower frequency output signal.
Down link	A transmission path carrying information from a satellite or spacecraft to earth.
DP	Data processing
DPU	Digital processing unit
DSP	Digital signal processor
DSR	Digital Storage and Retrieval System
D to U	Desired to undesired signal ratio
DTMF	Dual Tone Multiple Frequency
Duplexer	A device which permits the connection of both a receiver and a transmitter to a common antenna.
DVM	Digital voltmeter
DWDM	Dense Wave Division Multiplexing
ECL	Emitter coupled logic
ECM	Entitlement Control Message
EDFA	Erbium Doped Fiber Amplifier
EEPROM	Electrically Erasable Programmable Read-Only Memory
EIA	Electronics Industry Association
EMI	Electromagnetic interference
Emission designer	An FCC or CCIR code that defines the format of radiation from a transmitter.
EPROM	Erasable Programmable Read-Only Memory
EQ	Equalizer

Optoelectronic Glossary, Continued

Equalization	The process of compensating for an undesired result. For example, equalizing tilt in a distribution system.
ERP	Effective radiated power
FAOC	Frequency agile output converters
FER	Frame error rate
FET	Field-effect transistor
FIFO	First in, first out
FM	Frequency modulation
Forward path	Signal direction from the headend to the set-top terminal.
FP	Fabry-Perot laser
FPGA	Field Programmable Gate Array. A flexible logic device with thousands of gates
Fiber	A single strand of glass used as an optical transmission medium; or a bundle of glass strands in a CATV system.
Frequency	The number of similar shapes in a unit of time. For example, the number of sine waves moving past a fixed point in a second.
Frequency Agile	The ability to change from one frequency to another without changing components.
Frequency Modulation	A system of modulation where the instantaneous radio frequency of the carrier varies in proportion to the instantaneous amplitude of the modulating signal while the amplitude of the radio frequency carrier is independent of the amplitude of the modulating signal.
Frequency Response	The effect that changing the frequency has on the magnitude of a signal.
Frequency Stability	A measure of the departure from nominal frequency value of a signal, with respect to time, temperature, or other influence.
FSM	Field strength meter
FSK	Frequency-shift keying

Optoelectronic Glossary, Continued

ft-lb	Foot-pound
FTP	File Transfer Protocol
Gain	An increase in signal relative to a reference
Gbps	Gigabits per second
Headend	Location and equipment that receives data from a satellite (or other) source and reformats that data for input to a broadband distribution network.
HEDA	Headend Driver Amplifier
HGD	High Gain Dual
Hertz	A unit of frequency equal to one cycle per second.
Hetrodyne	Changing the frequency of a signal by mixing it with another signal to get the sum and difference of the two.
I/O	Input/output
IC	Integrated circuit
ICIM	Intelligent Communications Interface Module
ICP	Internal Control Program. A series of policies to protect company sensitive and export controlled information.
IDR	Intermediate Data Rate
IEC	International Electro-technical Commission
IF	Intermediate frequency
IFL	Interfacility link
IP	Internet protocol
ITU	International Telecommunications Union
Kbps	Kilobits per second
in-lb	Inch-pound
LCD	Liquid crystal display

Optoelectronic Glossary, Continued

LCI	Local craft interface
LED	Light-emitting diode
LIFO	Last-in, first-out
LNA	Low-noise amplifier
LNB	Low-noise block converter
LNC	Low-noise converter
Mbps	Megabits per second
MCU	Master Control Unit
Multipath (multipath transmission)	The phenomenon which results from a signal traveling from point to point by more than one path so that several copies of the signal arrive at the destination at different times or at different angles.
mux	multiplexed
Nanosecond	1 thousandth of a microsecond
Nm	Newton meter
NIU	Network Interface Unit
Node	A branching or exchange point.
OEM	Original equipment manufacturer
OOB	Out of band
OIM	Optical interface module
OSM	Optical-Sub module
PCB	Printed circuit board
PCM	Pulse code modulation
PDI	Pressure differential indicator
PDU	Power distribution unit
PIN	PIN Photodiode - A standard photodiode. (PIN stands for Positive doped - Intrinsic region - Negative doped and has to do with the chip architecture)

Optoelectronic Glossary, Continued

PLL	Phase Lock Loop. An electronic servo system controlling an oscillator to maintain a constant phase angle relative to a reference signal.
PROM	Programmable Read Only Memory
PWB	Printed wiring board
QAM	Quadrature Amplitude Modulation
QPR	Quadrature Partial Response
QPSK	Quadrature Phase-Shift Keying
RC	Reverse conditioner
Reverse path	Signal flow direction toward the headend.
RF	Radio frequency
RF Bypass	A bypass feature that allows subscribers to view a clear analog channel while recording a digital or analog channel on a VCR.
RFI	Radio frequency interference
RMA	Return material authorization
RMS	Root Mean Square
Router	A data communications device which examines a packet and routes the packet to an output port appropriate to the packet destination.
RS	Remote Sensing
RX	Receive or receiver
SA	Spectrum analyzer
SAM	Signal analysis meter
SAT	Site acceptance test
S-band	The group of frequencies between 2 and 4 GHz.
SET	Secure electronic transaction

Optoelectronic Glossary, Continued

Scattering	Random directional change of a wave or part of a wave caused by an irregular reflecting surface or by passing through an inhomogeneous transmission medium.
SLM	Signal level meter
SM	Status monitor
SMC	Status monitoring and control
SMIU	Status Monitor Interface Unit
SMU	Server Management Unit
S/N or SNR	Signal-to-noise ratio
SNMP	Simple Network Management Protocol
SONET	Synchronous optical network
SP	Splitter. It is a device that divides power from an input to deliver multiple outputs or combines multiple input into one output.
Spread Spectrum	A modulation technique to spread a narrow band signal over a wide band of frequencies.
Spurious	Anything other than the desired result
SSPA	Solid-state power amplifier
Sweep generator	A signal source which can automatically vary its frequency continuously from one frequency to another.
Synchronous transmission	A method of sending information over a path and separating discrete characters and symbols by a precise separation in time.
TEC	Thermo-electric cooler
TCP/IP	Transmission control protocol/internet protocol
TDM	Time division multiplexing
TNCS	Transmission Network Control System
Torque	Force applied to bolt or screw to tighten the device.
TS	Transport Stream

Optoelectronic Glossary, Continued

TTCN	True tilt correction network
Tx	Transmit or transmitter
UBT	Unbalanced triple
UPS	Un-interruptible power supply
Upstream	Signal transmission toward the headend
UTP	Unshielded twisted pair
uV	One millionth of a volt (microvolt)
V	Volt
V AC	Volts alternating current
VBR	Variable bit rate
VCA	Voltage controlled attenuator
V DC	Volts direct current
VOD	Video-on-demand
VOM	Volt ohm meter
W	Watts
WDM	Wave Division Multiplexing
YEDFA	Ytterbium/erbium doped fiber amplifier

Index

A

alarms

- checking using ICIM, 3-25
- checking using LCI, 4-22
- data display using ICIM, 3-24
- troubleshooting using ICIM, 5-4
- troubleshooting using LCI, 5-5

B

- bdr digital reverse multiplexing system, 1-3
- bicolor LED, 1-6
- block diagram, 1-4

C

chassis

- cable connections, 2-6
- front access, 2-5
- rear access, 2-5

compliance, vii

configuration

- attenuation, 1-10
- complete, 3-32
- frame error counting, 1-10
- frequency band, 1-9
- methods, 1-8
- redundant mode, 1-9
- RF output, 1-10
- saving using ICIM, 3-32
- summary, 1-8
- switch function, 1-9
- using LCI, 4-21

connectors

- back panel, 1-7
- cleaning optical, 5-12
- input, 1-3
- power and communications, 1-7

D

device

- details window, 4-14
- properties, 4-24
- tree overview, 4-13

E

- electromagnetic compatibility, vii
- equipment and tools needed, 2-2
- equipment rack, 2-3

F

- factory service, vi
- fan tray requirement, 3-2
- Fiber Fish tool, 2-9

I

ICIM

- block diagram, 3-2
- front panel features, 3-4
- front panel illustration, 3-3
- function, 3-2
- key pad, 3-5
- operating, 3-12
- password, 3-8

indicator

- alarm, 1-5
- power on, 1-5

L

LCI

- computer requirements, 4-4
- configuring, 4-19
- connecting to chassis, 4-10
- driver upgrade, 4-5
- installation, 4-6
- operating status, 4-17
- software installation, 4-6
- starting software, 4-11
- troubleshooting, 5-6

M

menu

- ALARM using ICIM, 3-27
- CONFIG using ICIM, 3-22
- ICIM, 3-13
- ICIM menu structure, 3-14
- ICIM processor software structure, 3-15

Index, Continued

- MAIN menu structure using ICIM, 3-14
- MAIN using ICIM, 3-12
- MFG. DATA using ICIM, 3-31
- STATUS using ICIM, 3-18
- module maintenance, 5-2

O

- optical
 - connectors, 5-12
 - input, 1-3
- optical receiver, 1-6

P

- parameters
 - configuring with ICIM, 3-21
 - configuring with LCI, 4-19
 - monitored using ICIM, 3-16
- password
 - changing, 3-10
 - disabling, 3-11
 - expired in ICIM, 3-7
 - first time use, 3-8
 - function with ICIM, 3-7
 - ICIM, 3-6
 - re-entering, 3-9
 - rejected, 3-8, 3-9
 - user, 3-6

R

- receive processor
 - back panel, 1-7

- block diagram, 1-4
- front panel, 1-5
- installation, 2-7
- redundancy
 - external, 1-9
- Redundancy Interface Panel
 - features, 2-15
 - installation and connections, 2-16
 - introduction, 2-14
 - master/slave connections, 2-18

S

- safety
 - laser, viii, ix
 - laser & electrical, vii
 - precautions, v
- Scientific-Atlanta website, 4-5
- status
 - checking using ICIM, 3-17
 - checking using LCI, 4-18
 - checking with LCI, 4-18

T

- troubleshooting
 - alarm conditions, 5-4
 - general, 5-3
 - LCI software, 5-6

W

- warning labels, ix
- warranty, x



Cisco Systems, Inc.
5030 Sugarloaf Parkway, Box 465447
Lawrenceville, GA 30042

678 277-1120
800 722-2009
www.cisco.com

This document includes various trademarks of Cisco Systems, Inc. Please see the Notices section of this document for a list of the Cisco Systems, Inc. trademarks used in this document.

Product and service availability are subject to change without notice.

© 201, 2008, 2012 Cisco and/or its affiliates.

All rights reserved.

October 2012 Printed in USA

Part Number 78-748556-01 Rev D