



Prisma II Standard and Low Input Optical Switches

Installation and Operation Guide







For Your Safety

Explanation of Warning and Caution Icons



Avoid personal injury and product damage! Do not proceed beyond any symbol until you fully understand the indicated conditions.

The following warning and caution icons alert you to important information about the safe operation of this product:

-  **You may find this symbol in the document that accompanies this product. This symbol indicates important operating or maintenance instructions.**
-  **You may find this symbol affixed to the product. This symbol indicates a live terminal where a dangerous voltage may be present; the tip of the flash points to the terminal device.**
-  **You may find this symbol affixed to the product. This symbol indicates a protective ground terminal.**
-  **You may find this symbol affixed to the product. This symbol indicates a chassis terminal (normally used for equipotential bonding).**
-  **You may find this symbol affixed to the product. This symbol warns of a potentially hot surface.**
-  **You may find this symbol affixed to the product and in this document. This symbol indicates an infrared laser that transmits intensity-modulated light and emits invisible laser radiation or an LED that transmits intensity-modulated light.**

Important

Please read this entire guide. If this guide provides installation or operation instructions, give particular attention to all safety statements included in this guide.

Notices

Trademark Acknowledgments

Cisco and the Cisco logo are trademarks or registered trademarks of Cisco and/or its affiliates in the U.S. and other countries. A listing of Cisco's trademarks can be found at www.cisco.com/go/trademarks.

Third party trademarks mentioned are the property of their respective owners.

The use of the word partner does not imply a partnership relationship between Cisco and any other company. (1110R)

Publication Disclaimer

Cisco Systems, Inc. assumes no responsibility for errors or omissions that may appear in this publication. We reserve the right to change this publication at any time without notice. This document is not to be construed as conferring by implication, estoppel, or otherwise any license or right under any copyright or patent, whether or not the use of any information in this document employs an invention claimed in any existing or later issued patent.

Copyright

© 2008, 2013 Cisco and/or its affiliates. All rights reserved. Printed in the United States of America.

Information in this publication is subject to change without notice. No part of this publication may be reproduced or transmitted in any form, by photocopy, microfilm, xerography, or any other means, or incorporated into any information retrieval system, electronic or mechanical, for any purpose, without the express permission of Cisco Systems, Inc.

Contents

Important Safety Instructions	v
Laser Safety	xiii
Chapter 1	Introduction
Description.....	1-2
The Front Panel	1-4
The Back Panel	1-5
Configuration Overview	1-6
Chapter 2	Installation
Preparing for Installation.....	2-2
Site Requirments	2-3
Installing the Module in the Chassis	2-6
Connecting Optical Cables	2-8
Connecting the ICIM to Additional Chassis	2-12
Connection the Chassis to the TNCS Server	2-13
Chapter 3	Operation Using the ICIM
ICIM Introduction.....	3-2
The ICIM Front Panel	3-3
The ICIM Password	3-6
Operating the ICIM.....	3-13
Monitoring Operating Status Using the ICIM	3-17
Configuring the Optical Switch Using the ICIM.....	3-20
Checking Optical Switch Alarms Using the ICIM	3-23
Checking Manufacturing Data Using the ICIM	3-26
Using the ICIM to Save the Configuration.....	3-28
SNMP Configuration.....	3-29
Community NAmes	3-33
Setting SNMP Trap Receiver Parameters	3-34
New SNMP Features	3-35

Contents, Continued

Chapter 4	Operation Using LCI	
	LCI Introduction	4-2
	System Requirements	4-3
	Installing LCI	4-4
	Connecting Your Computer to the Chassis	4-7
	Starting LCI	4-8
	LCI Module Tree Overview	4-9
	Accessing the Module Details Window	4-11
	Checking the Operating Status	4-18
	Configuring the Optical Switch	4-20
	Checking Optical Switch Alarms	4-24
	Modifying Optical Switch Alarm Limits	4-26
	Checking Manufacturing Data	4-29

Important Safety Instructions

Read and Retain Instructions

Carefully read all safety and operating instructions before operating this equipment, and retain them for future reference.

Follow Instructions and Heed Warnings

Follow all operating and use instructions. Pay attention to all warnings and cautions in the operating instructions, as well as those that are affixed to this equipment.

Terminology

The terms defined below are used in this document. The definitions given are based on those found in safety standards.

Service Personnel - The term *service personnel* applies to trained and qualified individuals who are allowed to install, replace, or service electrical equipment. The service personnel are expected to use their experience and technical skills to avoid possible injury to themselves and others due to hazards that exist in service and restricted access areas.

User and Operator - The terms *user* and *operator* apply to persons other than service personnel.

Ground(ing) and Earth(ing) - The terms *ground(ing)* and *earth(ing)* are synonymous. This document uses *ground(ing)* for clarity, but it can be interpreted as having the same meaning as *earth(ing)*.

Electric Shock Hazard

This equipment meets applicable safety standards.



WARNING!

To reduce risk of electric shock, perform only the instructions that are included in the operating instructions. Refer all servicing to qualified service personnel only.

Electric shock can cause personal injury or even death. Avoid direct contact with dangerous voltages at all times. The protective ground connection, where provided, is essential to safe operation and must be verified before connecting the power supply.

Know the following safety warnings and guidelines:

- **Dangerous Voltages**
 - Only qualified service personnel are allowed to perform equipment installation or replacement.
 - Only qualified service personnel are allowed to remove chassis covers and access any of the components inside the chassis.
- **Grounding**
 - Do not violate the protective grounding by using an extension cable, power cable, or autotransformer without a protective ground conductor.
 - Take care to maintain the protective grounding of this equipment during service or repair and to re-establish the protective grounding before putting this equipment back into operation.

Important Safety Instructions, Continued

Installation Site

When selecting the installation site, comply with the following:

- **Protective Ground** - The protective ground lead of the building's electrical installation should comply with national and local requirements.
- **Environmental Condition** - The installation site should be dry, clean, and ventilated. Do not use this equipment where it could be at risk of contact with water. Ensure that this equipment is operated in an environment that meets the requirements as stated in this equipment's technical specifications, which may be found on this equipment's data sheet.

Equipment Placement



WARNING:

Avoid personal injury and damage to this equipment. An unstable mounting surface may cause this equipment to fall.

To protect against equipment damage or injury to personnel, comply with the following:

- Install this equipment in a restricted access location.
- Do not install near any heat sources such as radiators, heat registers, stoves, or other equipment (including amplifiers) that produce heat.
- Place this equipment close enough to a mains AC outlet to accommodate the length of this equipment's power cord.
- Route all power cords so that people cannot walk on, place objects on, or lean objects against them. This may pinch or damage the power cords. Pay particular attention to power cords at plugs, outlets, and the points where the power cords exit this equipment.
- Use only with a cart, stand, tripod, bracket, or table specified by the manufacturer, or sold with this equipment.
- Make sure the mounting surface or rack is stable and can support the size and weight of this equipment.
- The mounting surface or rack should be appropriately anchored according to manufacturer's specifications. Ensure this equipment is securely fastened to the mounting surface or rack where necessary to protect against damage due to any disturbance and subsequent fall.

Ventilation

This equipment has openings for ventilation to protect it from overheating. To ensure equipment reliability and safe operation, do not block or cover any of the ventilation openings. Install the equipment in accordance with the manufacturer's instructions.

Important Safety Instructions, Continued

Rack Mounting Safety Precautions

Mechanical Loading

Make sure that the rack is placed on a stable surface. If the rack has stabilizing devices, install these stabilizing devices before mounting any equipment in the rack.



WARNING:

Avoid personal injury and damage to this equipment. Mounting this equipment in the rack should be such that a hazardous condition is not caused due to uneven mechanical loading.

Reduced Airflow

When mounting this equipment in the rack, do not obstruct the cooling airflow through the rack and mount the blanking plates to cover unused rack space. Additional components such as combiners and net strips should be mounted at the back of the rack, so that the free airflow is not restricted.



CAUTION:

Installation of this equipment in a rack should be such that the amount of airflow required for safe operation of this equipment is not compromised.

Elevated Operating Ambient Temperature

Only install this equipment in a humidity- and temperature-controlled environment that meets the requirements given in this equipment's technical specifications.



CAUTION:

If installed in a closed or multi-unit rack assembly, the operating ambient temperature of the rack environment may be greater than room ambient temperature. Therefore, consideration should be given to installing this equipment in an environment compatible with the manufacturer's maximum rated ambient temperature.

Handling Precautions

When moving a cart that contains this equipment, check for any of the following possible hazards:



WARNING:



Avoid personal injury and damage to this equipment! Move any equipment and cart combination with care. Quick stops, excessive force, and uneven surfaces may cause this equipment and cart to overturn.

- Use caution when moving this equipment/cart combination to avoid injury from tip-over.

Important Safety Instructions, Continued

- If the cart does not move easily, this condition may indicate obstructions or cables that may need to be disconnected before moving this equipment to another location.
- Avoid quick stops and starts when moving the cart.
- Check for uneven floor surfaces such as cracks or cables and cords.

Grounding

This section provides instructions for verifying that the equipment is properly grounded.

Safety Plugs (USA Only)

This equipment is equipped with either a 3-terminal (grounding-type) safety plug or a 2-terminal (polarized) safety plug. The wide blade or the third terminal is provided for safety. Do not defeat the safety purpose of the grounding-type or polarized safety plug.

To properly ground this equipment, follow these safety guidelines:

- **Grounding-Type Plug** - For a 3-terminal plug (one terminal on this plug is a protective grounding pin), insert the plug into a grounded mains, 3-terminal outlet.
Note: This plug fits only one way. If this plug cannot be fully inserted into the outlet, contact an electrician to replace the obsolete 3-terminal outlet.
- **Polarized Plug** - For a 2-terminal plug (a polarized plug with one wide blade and one narrow blade), insert the plug into a polarized mains, 2-terminal outlet in which one socket is wider than the other.
Note: If this plug cannot be fully inserted into the outlet, try reversing the plug. If the plug still fails to fit, contact an electrician to replace the obsolete 2-terminal outlet.

Grounding Terminal

If this equipment is equipped with an external grounding terminal, attach one end of an 18-gauge wire (or larger) to the grounding terminal; then, attach the other end of the wire to a ground, such as a grounded equipment rack.

Safety Plugs (European Union)

- **Class I Mains Powered Equipment** – Provided with a 3-terminal AC inlet and requires connection to a 3-terminal mains supply outlet via a 3-terminal power cord for proper connection to the protective ground.
Note: The equipotential bonding terminal provided on some equipment is not designed to function as a protective ground connection.
- **Class II Mains Powered Equipment** – Provided with a 2-terminal AC inlet that may be connected by a 2-terminal power cord to the mains supply outlet. No connection to the protective ground is required as this class of equipment is provided with double or reinforced and/or supplementary insulation in addition to the basic insulation provided in Class I equipment.
Note: Class II equipment, which is subject to EN 50083-1, is provided with a chassis mounted equipotential bonding terminal. See the section titled **Equipotential Bonding** for connection instructions.

Important Safety Instructions, Continued

Equipotential Bonding

If this equipment is equipped with an external chassis terminal marked with the IEC 60417-5020 chassis icon () , the installer should refer to CENELEC standard EN 50083-1 or IEC standard IEC 60728-11 for correct equipotential bonding connection instructions.

AC Power

Important: If this equipment is a Class I equipment, it must be grounded.

- If this equipment plugs into an outlet, the outlet must be near this equipment, and must be easily accessible.
- Connect this equipment only to the power sources that are identified on the equipment-rating label normally located close to the power inlet connector(s).
- This equipment may have two power sources. Be sure to disconnect all power sources before working on this equipment.
- If this equipment **does not** have a main power switch, the power cord connector serves as the disconnect device.
- Always pull on the plug or the connector to disconnect a cable. Never pull on the cable itself.
- Unplug this equipment when unused for long periods of time.

Connection to -48 V DC/-60 V DC Power Sources

Refer to this equipment's specific installation instructions in this manual or in companion manuals in this series for connection to nominal -48 V DC/-60 V DC power sources.

Circuit Overload

Know the effects of circuit overloading before connecting this equipment to the power supply.



CAUTION:

Consideration should be given to the connection of this equipment to the supply circuit and the effect that overloading of circuits might have on overcurrent protection and supply wiring. Appropriate consideration of information given on the equipment-rating label should be used when addressing this concern.

General Servicing Precautions



WARNING:

Avoid electric shock! Opening or removing this equipment's cover may expose you to dangerous voltages.

Be aware of the following general precautions and guidelines:

- **Servicing** - Refer all servicing to qualified service personnel. Servicing is required when this equipment has been damaged in any way, such as power supply cord or plug is damaged, liquid has been spilled or objects have fallen into this equipment, this equipment has been exposed to rain or moisture, does not operate normally, or has been dropped.

Important Safety Instructions, Continued

- **Wristwatch and Jewelry** - For personal safety and to avoid damage of this equipment during service and repair, do not wear electrically conducting objects such as a wristwatch or jewelry.
- **Lightning** - Do not work on this equipment, or connect or disconnect cables, during periods of lightning.
- **Labels** - Do not remove any warning labels. Replace damaged or illegible warning labels with new ones.
- **Covers** - Do not open the cover of this equipment and attempt service unless instructed to do so in the instructions. Refer all servicing to qualified service personnel only.
- **Moisture** - Do not allow moisture to enter this equipment.
- **Cleaning** - Use a damp cloth for cleaning.
- **Safety Checks** - After service, assemble this equipment and perform safety checks to ensure it is safe to use before putting it back into operation.

Electrostatic Discharge

Electrostatic discharge (ESD) results from the static electricity buildup on the human body and other objects. This static discharge can degrade components and cause failures.

Take the following precautions against electrostatic discharge:

- Use an anti-static bench mat and a wrist strap or ankle strap designed to safely ground ESD potentials through a resistive element.
- Keep components in their anti-static packaging until installed.
- Avoid touching electronic components when installing a module.

Fuse Replacement

To replace a fuse, comply with the following:

- Disconnect the power before changing fuses.
- Identify and clear the condition that caused the original fuse failure.
- Always use a fuse of the correct type and rating. The correct type and rating are indicated on this equipment.

Lithium Battery

For equipment with a lithium battery, observe the following rules:

- Do not dispose of used batteries through the regular garbage collection system, but follow the local regulations. The batteries may contain substances that could be harmful to the environment.
- Replace batteries with the same or equivalent type recommended by Cisco.
- Insert batteries correctly. There may be a risk of explosion if the batteries are incorrectly inserted.
- When disposing of this equipment, remove the batteries and dispose of them separately in accordance with local regulations.
- Do not recharge the batteries or expose them to temperatures above 100°C (212°F).

Important Safety Instructions, Continued

Electromagnetic Compatibility Regulatory Requirements

This equipment meets applicable electromagnetic compatibility (EMC) regulatory requirements. EMC performance is dependent upon the use of correctly shielded cables of good quality for all external connections, except the power source, when installing this equipment.

- Ensure compliance with cable/connector specifications and associated installation instructions where given elsewhere in this manual.

Otherwise, comply with the following good practices:

- Multi-conductor cables should be of single-braided, shielded type and have conductive connector bodies and backshells with cable clamps that are conductively bonded to the backshell and capable of making 360° connection to the cable shielding. Exceptions from this general rule will be clearly stated in the connector description for the excepted connector in question.
- Ethernet cables should be of single-shielded or double-shielded type.
- Coaxial cables should be of the double-braided shielded type.

EMC

Where this equipment is subject to USA FCC and/or Industry Canada rules, the following statements apply:

FCC Statement

This equipment has been tested and found to comply with the limits for a Class A digital device according to Part 15 of FCC Rules. These limits are designed to provide reasonable protection against harmful interference when this equipment is operated in a commercial environment.

This equipment generates, uses, and can radiate radio frequency energy and, if not installed and used in accordance with the instruction manual, may cause harmful interference to radio communications. Operation of this equipment in a residential area is likely to cause harmful interference in which case the user will be required to correct the interference at his own expense.

Industry Canada – Industrie Canadienne Statement

Industry Canada ICES-003: This Class A digital apparatus meets all the requirements of the Canadian Interference-Causing Equipment Regulations.

Industrie Canadienne ICES-003: Cet appareil numérique de la Class A respecte toutes les exigences du Règlement sur le matériel brouilleur du Canada.

CENELEC/CISPR Statement with Respect to Class A Information Technology Equipment

This is a Class A equipment. In a domestic environment this equipment may cause radio interference in which case the user may be required to take adequate measures.

Important Safety Instructions, Continued

Modifications

This equipment has been designed and tested to comply with applicable safety, laser safety, and EMC regulations, codes, and standards to ensure safe operation in its intended environment.

Do not make modifications to this equipment. Any changes or modifications could void the user's authority to operate this equipment.

Modifications have the potential to degrade the level of protection built into this equipment, putting people and property at risk of injury or damage. Those persons making any modifications expose themselves to the penalties arising from proven non-compliance with regulatory requirements and to civil litigation for compensation in respect of consequential damages or injury.

Accessories

Use only attachments or accessories specified by the manufacturer.

Laser Safety

Introduction

This equipment contains an infrared laser that transmits intensity-modulated light and emits invisible radiation.

Warning: Radiation



WARNINGS:

- **Avoid personal injury! Use of controls, adjustments, or performance of procedures other than those specified herein may result in hazardous radiation exposure.**
- **Avoid personal injury! The laser light source on this equipment emits invisible laser radiation. Avoid direct exposure to the laser light source.**
- Do not apply power to this equipment if the fiber is unmated or unterminated.
- Do not stare into an unmated fiber or at any mirror-like surface that could reflect light that is emitted from an unterminated fiber.
- Do not view an activated fiber with optical instruments (e.g., eye loupes, magnifiers, microscopes).
- Use safety-approved optical fiber cable to maintain compliance with applicable laser safety requirements.

Warning: Fiber Optic Cables



WARNING:

Avoid personal injury! Qualified service personnel may only perform the procedures in this manual. Wear safety glasses and use extreme caution when handling fiber optic cables, particularly during splicing or terminating operations. The thin glass fiber core at the center of the cable is fragile when exposed by the removal of cladding and buffer material. It easily fragments into glass splinters. Using tweezers, place splinters immediately in a sealed waste container and dispose of them safely in accordance with local regulations.

Laser Safety, Continued

Safe Operation For Software Controlling Optical Transmission Equipment

If this manual discusses software, the software described is used to monitor and/or control Cisco and other vendors' electrical and optical equipment designed to transmit video, voice, or data signals. Certain safety precautions should be observed when operating equipment of this nature.

For equipment specific safety requirements, refer to the appropriate section of the equipment documentation.

For safe operation of this software, refer to the following warnings.



WARNINGS:

- **Ensure that all optical connections are complete or terminated before using this equipment to remotely control a laser device. An optical or laser device can pose a hazard to remotely located personnel when operated without their knowledge.**
- **Allow only personnel trained in laser safety to operate this software. Otherwise, injuries to personnel may occur.**
- **Restrict access of this software to authorized personnel only.**
- **Install this software in equipment that is located in a restricted access area.**

Product Specific Laser Information

The following laser beam safety precautions are applicable to this equipment. Information about the beam is available on this equipment identification label. A laser label that clearly indicates the laser beam aperture is affixed to this equipment's front panel.

The Prisma II Optical Switch bears the following labels.



T10149



Fiber Input



Fiber Output

Laser Safety, Continued

Laser Radiation Warning Labels and Laser Beam Apertures

The following illustration displays the location of the laser radiation warning labels and laser beam apertures on this equipment.

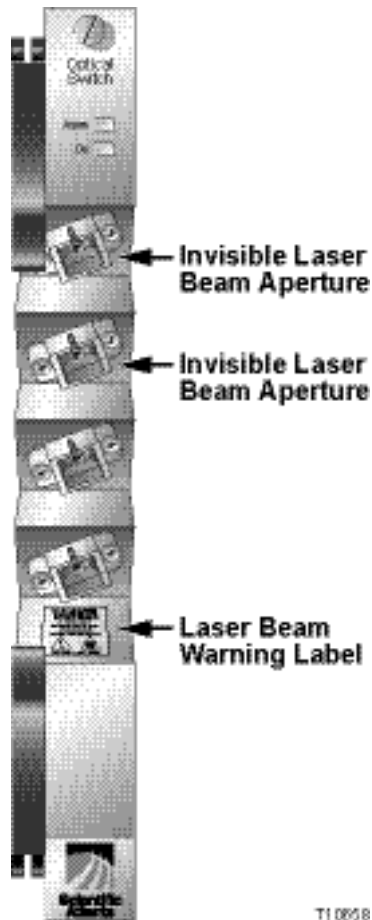

T10858

Chapter 1

Introduction

Overview

Introduction

This chapter describes the front and back panels, and presents a setup summary for the Prisma II™ Standard and Low Input Optical Switches.

Qualified Personnel

Only appropriately qualified and trained personnel should attempt to install this product.



WARNING:

Allow only qualified personnel to install, operate, maintain, and service this product. Otherwise, personal injury or equipment damage may occur.

Who Should Use This Guide

This guide is intended for authorized personnel who have experience working with similar equipment. The personnel should have appropriate background and knowledge to complete the procedures described in this guide.

In This Chapter

This chapter contains the following topics.

Topic	See Page
Description	1-2
The Front Panel	1-4
The Back Panel	1-5
Configuration Overview	1-6

Description

Overview

The Prisma II Optical Switches are designed for use with the Prisma platform for indoor applications, such as headend and central office environments. The switch is meant primarily for backup of externally modulated transmitters (EMT), in-line Erbium Doper Fiber Amplifiers (EDFA), and transmitter redundancy. The switch detects loss of optical power, with threshold and hysteresis values prescribed by front panel operation.

Features

The Standard and Low Input Optical Switch has the following features:

- Front panel green light emitting diode (LED) to indicate operating status
- Front panel red LED to indicate alarm status
- Optical input/output connectors
- Plug-and-play capability
- Compatible with Cisco Intelligent Communications Interface Module (ICIM), Local Craft Interface (LCI) software, and Transmission Networks Control System (TNCS) software
- Blind mate chassis connections

Optical Switch Activation

The Standard and Low Input Optical Switch may be activated by one of four methods.

- Loss of light
- LCI
- TNCS
- ICIM

Description, Continued

Optical Switch Operation

The switch may be operated in manual or automatic mode.

- In manual mode, the switch is triggered by three methods: ICIM, LCI software, or TNCS software.
- In automatic mode, the switch is triggered automatically by loss of one of the input signals (based on user selection).

The optical signal enters the module through a connector on the front of the module. The signal then passes through an optical splitter where a portion is tapped off for optical power monitoring. After the splitter, the signal is routed to the switch where it either passes through on the through path or is routed to the switched path. The signal then passes out of the module through an optical connector on the front panel.

Optical Output

Depending on how you ordered your system, the optical output connectors may either be an SC/APC, SC/UPC, FC/UPC, or E2000/APC.

⚠ WARNING:
Avoid damage to your eyes! Do not look into any optical connector while the system is active. Even if the unit is off, there may still be hazardous optical levels present.

Optical Switch Block Diagram

A block diagram of the Prisma II Optical Switch is shown below.

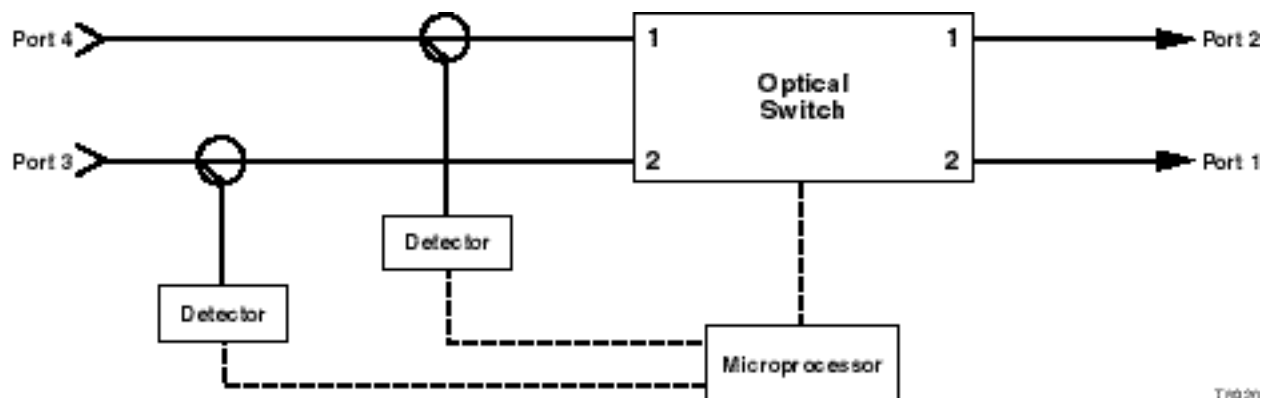

The Front Panel

Overview

The features of the front panel of the Prisma II Optical Switch are shown below.

Part	Function
Alarm Indicator	Illuminates or blinks when an alarm condition occurs.
Power On Indicator	Illuminates when power is supplied to the module.
Optical Output	Connects the output signal to the optical cable.
Optical Input	Connects the input cable to the optical switch.

Illustration

The front panel of the Standard and Low Input Optical Switch is shown below.

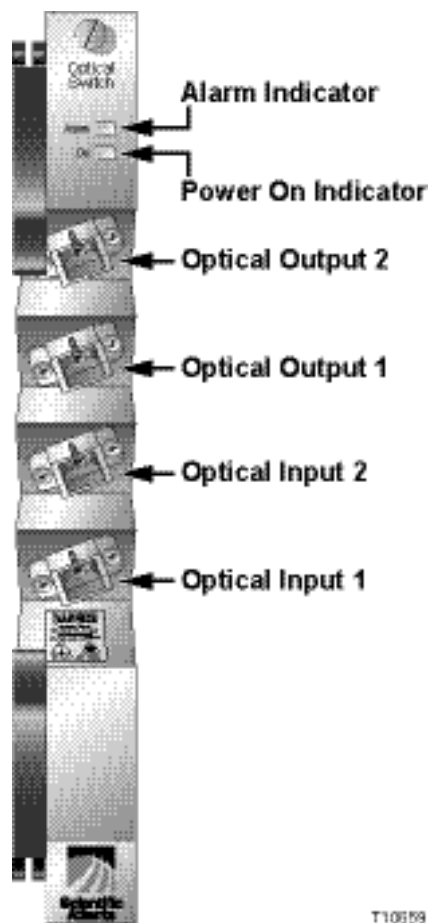

The Back Panel

Back Panel Connectors

Blind-mate connectors make it easy to install this module. The push-on connector on the back of the module mates with the backplane connector inside of the chassis. The 110-pin connector provides the following:

- Electrical power input connection
- Alarm communications
- Status-monitoring connections
- Communications and control connections

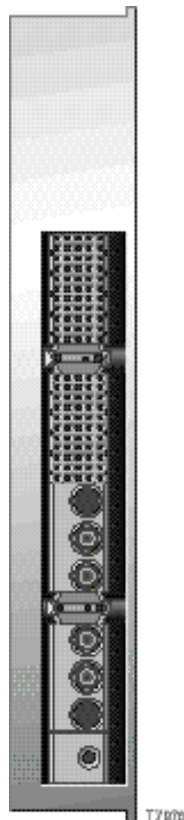

Power and Communications Connector

The power and communications connector on the back of the module mates with a connector inside of the chassis, and supplies power from the chassis to the optical switch. The 110-pin connector also routes alarm and status-monitoring and control information from the optical switch to the Prisma II Chassis.

Configuration Overview

Overview

The Standard and Low Input Optical Switches are shipped from the factory with operational parameters set to factory defaults. However, you will probably choose to configure the operating parameters so that they are best suited for your application.

Configuration and Monitoring Methods

The Standard and Low Input Optical Switch may be controlled using one of the methods below.

- The Prisma II ICIM

If an ICIM is installed in the Prisma II Chassis, it may be used to configure and monitor Prisma II application modules within its domain. For instructions on operating this module using the ICIM, refer to Chapter 3, **Operation Using the ICIM**.

- The LCI software

The LCI software running on a locally connected PC may be used to configure operating parameters of Prisma II modules. For instructions on operating this module using the LCI software, refer to Chapter 4, **Operation Using LCI**.

- Cisco's TNCS software

If the ICIM is installed, TNCS software may be used to configure and monitor all functions of the Prisma II modules. For instructions on operating this module using TNCS, see the manual that was shipped with the TNCS software, *TNCS Administrator Software User's Guide*, part number 730201.

Configuration Summary

Using any of the above methods, you can configure the following parameters.

- Switch position (cross or bar)
- Automatic or manual mode
- Input wavelength
- Nominal optical input powers
- Delta value
- Hysteresis amplitude
- Hysteresis time
- Revert (to primary position or remain in backup)
- Primary input
- Default switch position (cross or bar)

For detailed information on configuring this module, see Chapter 3, **Operation Using the ICIM** or Chapter 4, **Operation Using LCI**.

Chapter 2 Installation

Overview

Introduction

This chapter contains instructions, site requirements, equipment, and tools needed to install the Standard and Low Input Optical Switch.

Qualified Personnel



WARNING:

Allow only qualified personnel to install, operate, maintain, or service this product. Otherwise, personal injury or equipment damage may occur.

In This Chapter

This chapter gives step-by-step instructions on installing the Standard and Low Input Optical Switch.

Topic	See Page
Preparing for Installation	2-2
Site Requirements	2-3
Installing the Module in the Chassis	2-6
Connecting Optical Cables	2-8
Connecting the ICIM to Additional Chassis	2-12
Connecting the Chassis to the TNCS Server	2-13

Preparing for Installation

Overview

Before you begin, make sure that the module is in good condition and that you have the tools and equipment listed here.

Unpacking and Inspecting the Module

As you unpack the module, inspect it for shipping damage. If you find any damage, contact Cisco Services.

Equipment and Tools Needed

Before you begin, make sure that the module is in good condition. You need the following equipment and tools to install this module.

You need . . .	To . . .
a Prisma II Chassis with power supply	provide housing, power, and input/output connections to the module.
3/8-in. flat-blade screwdriver	secure the module in the chassis.
at least three optical cables with connectors	carry optical signals.

Site Requirements

Overview

Before you begin, make certain that your installation site meets the requirements discussed in this section.

Access Requirements

Ensure that only authorized personnel have access to this equipment. Otherwise, personal injury or equipment damage may occur.



WARNING:

Use this product in locations that restrict access to all persons who are not authorized. Otherwise, personal injury or equipment damage may occur.

Equipment Rack

To install this module, your site must be equipped with an Electronics Industry Association (EIA) equipment rack that properly houses the Prisma II Chassis with proper spacing for air circulation. For instructions on installing the chassis in the rack, refer to the guide that was shipped with the chassis.

Operating Environment



CAUTION:

Avoid damage to this product! Operating this product above the maximum operating temperature specified voids the warranty.

Follow these recommendations to maintain an acceptable operating temperature.

- Temperature inside the rack must be between -40°C and 65°C (-40°F and 149°F)
- Allow the optical switch to warm up for 5 to 10 minutes when below -10°C
- Keep cooling vents clear and free of obstructions.
- Provide ventilation, as needed, using one or more of the following methods.
 - air-deflecting baffles
 - forced-air ventilation
 - air outlets above enclosures

Site Requirements, Continued

Power Requirements

All Prisma II modules receive their electrical power from the Prisma II Chassis. The modules may be installed with the chassis powered-up.

Space Requirements

This module is a single-width module. It is usually installed in slots 5 through 16. Slots 1 through 4 are usually reserved for the power supplies. Slots 15 and 16 are reserved for the ICIM, if installed. If an ICIM is not installed, any other module could be installed in these slots. Slot 2 and slot 4 are reserved for an internal power supply, if installed. If an internal power supply is not installed here, any other module could be installed in these slots.

Chassis Style

The Prisma II Chassis may be configured with front or rear connectors depending on the system you have purchased. Power, RF input/output, and other connectors may be located on either the front or rear of the Prisma II Chassis. Connections to the chassis serve the same function and are made in the same manner regardless of the location of the connectors or chassis configuration.

Site Requirements, Continued

Rear Access Chassis Illustration

The Prisma II Chassis may be configured with front or rear connectors depending on the system you have purchased. The rear access chassis is shown here.

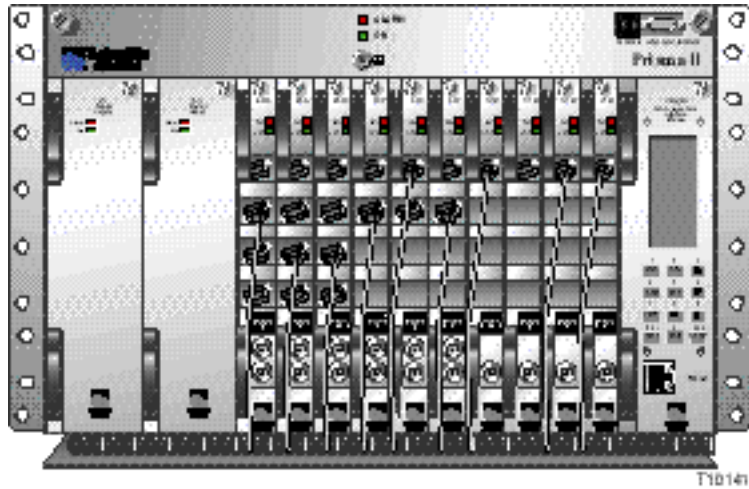

Front Access Chassis Illustration

The front access chassis is shown here.

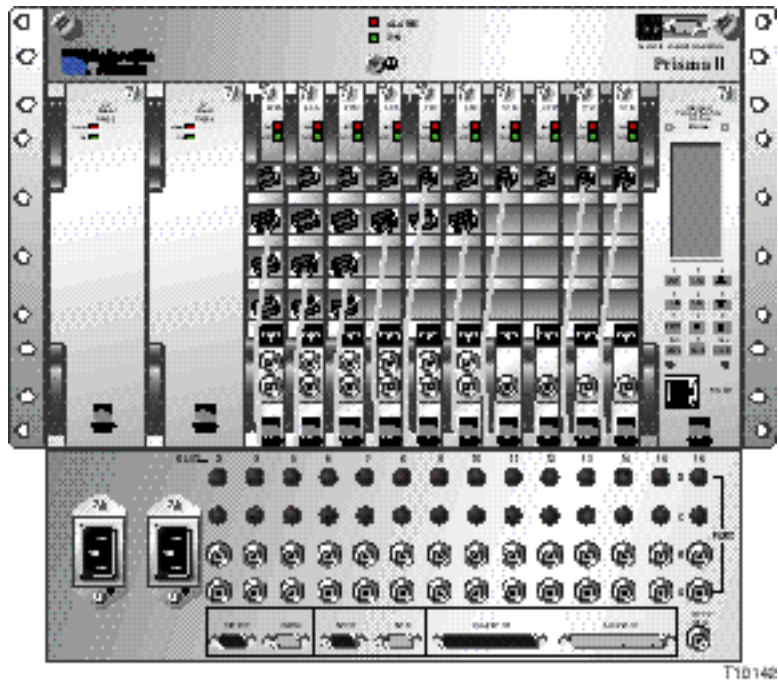

Installing the Module in the Chassis

Installing the Module

Important: The following procedure assumes the Prisma II Chassis is mounted in a rack. This procedure applies to both chassis styles.

This module is usually installed in slots 5 through 16. To install the module in the chassis, follow these steps.

1. Locate the fiber guides at the bottom of the chassis and the module guide slots inside the chassis as shown in the following illustration.

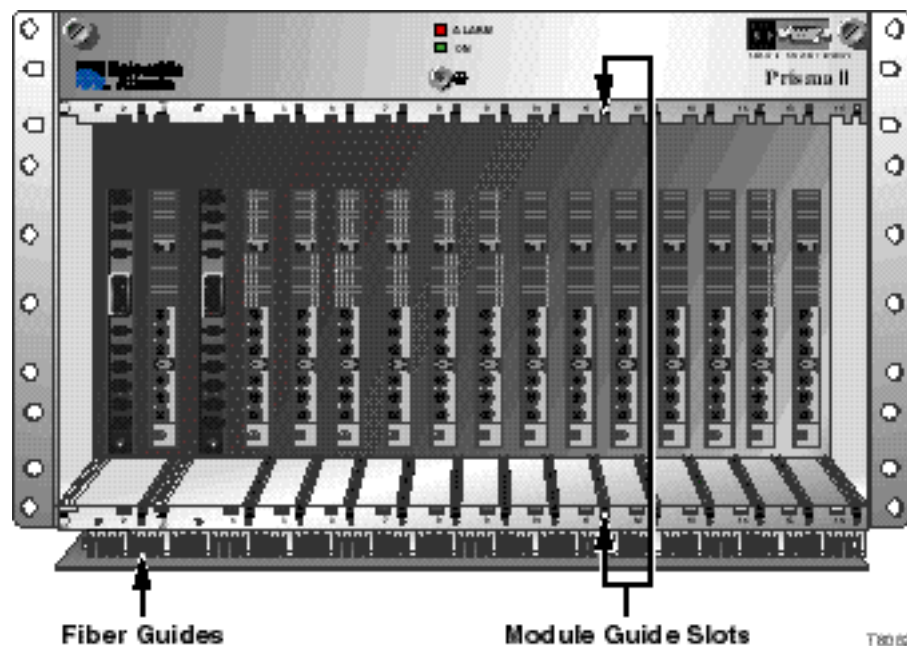

2. Align the ridges on the top and bottom of the module with the module guide slots located on the chassis. Module ejectors must be fully extended when inserting the module.

Installing the Module in the Chassis, Continued

3. Gently slide the module into the chassis until you feel the power and communications connections on the back of the module join connectors on the backplane. Use the module ejectors on the left side of the module to lock the module in place.

Do not force or bang the module into the chassis. If properly aligned, it should slide in with minimal force.



4. Secure the module by pressing the two ejector levers located on the left side of the module until they lock. When the levers are locked, the power and communications connections at the rear of the module mates with the communications connectors at the back of the chassis slot.
5. Hand-tighten the screw at the top of the module, to secure it in the chassis. Use a $\frac{3}{8}$ -in. flat-blade screwdriver to secure. **Do not over tighten.**

Connecting Optical Cables

The Fiber Fish Tool

The Fiber Fish tool that was shipped along with the Prisma II Chassis is used to pull an optical cable from the rear of the chassis to the front of the chassis so the optical cables can be connected to the optical connector on the front panel of Prisma II modules.

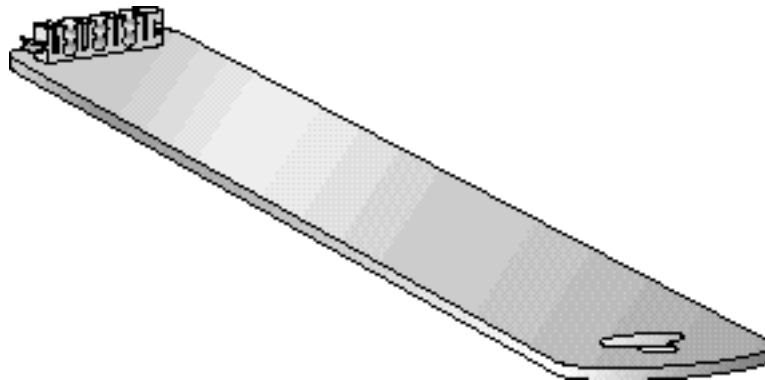

The Fiber Fish Tool Hook

At the end of the Fiber Fish tool is a small hook that allows you to hold an optical cable so that you can pull it through to the front panel of Prisma II Chassis.

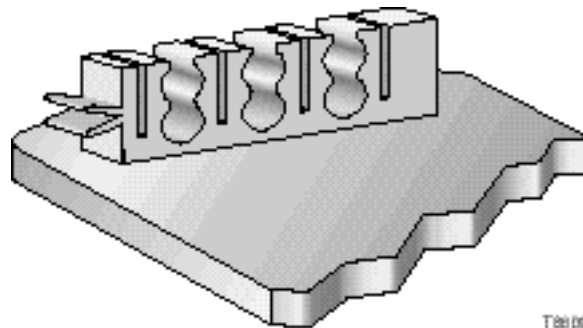

Connecting Optical Cables, Continued

Using the Fiber Fish to Pull the Optical Cable to the Prisma II Module

To pull an optical cable to the Prisma II modules, follow these procedures.

1. Insert the Fiber Fish tool through the slot located just above the bottom of the chassis.
2. At the rear of the chassis, locate the appropriate optical cable.
3. Insert the optical cable into notched area of the Fiber Fish tool as shown.

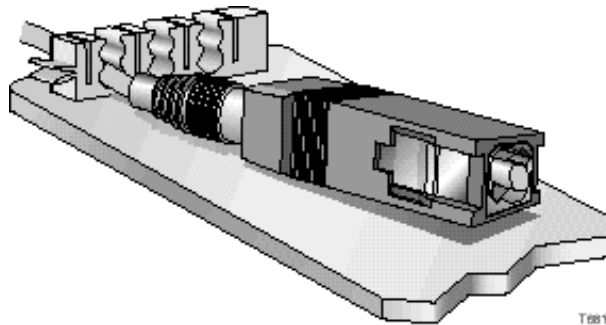

4. At the front of the chassis, pull the Fiber Fish tool (with cable attached) to the front of the chassis.
5. Disengage the optical cable from the Fiber Fish tool and attach to the appropriate connector on desired module. See **Cable Connection Procedure**.

Cleaning Optical Connectors

Cleaning fiber-optic connectors can help prevent interconnect problems and therefore aid system performance. When optical connectors are disconnected and reconnected, the fiber surface can become dirty or scratched. The goal of cleaning the fiber optic connectors is to remove all dust and contaminants without leaving any residue.

Required Equipment

The following equipment is required to clean the ends of fiber-optic connectors.

- Optical-grade (91%) isopropyl alcohol
- Lint-free wipes
- Compressed air (also called “canned air”)

Connecting Optical Cables, Continued

Tips for Optimal Fiber-Optic Connector Performance

Follow these guidelines to ensure optimal connector performance.

- Connect or disconnect optical connector only when necessary.
- Always use compressed air before cleaning the fiber-optic connectors.
- Use end caps on connectors when they are not in use.
- Always use compressed air to clean the end caps.
- Use optical-grade isopropyl alcohol of at least 91% or greater. Anything less than 91% isopropyl may leave a film on the fiber surface, creating more problems.
- Do not contaminate your alcohol supply.
 - Use a sprayer (a fountain pump is also adequate)
 - Do not put used alcohol back into the main container
- Use only lint-free wipes. Never use “Kleenex-type” tissues.
- If you have any degraded signal problems, clean the fiber-optic connector.

Cleaning Optical Connectors

Follow these steps to clean an optical connector.

1. Remove loose dirt or dust from the end of the connector by using compressed air (canned air) to blow dirt off the fiber and the connector.
2. Dampen a lint-free wipe with optical-grade (99%) isopropyl alcohol. If no wipes are available, use ferrule cleaner, part number 468517.
3. Clean the end of the connector using the lint-free wipe or ferrule cleaner.
4. Inspect the end of the connector for obvious contamination.
5. Mate the connector with an adapter or cover with an end cap.

Cable Connection Procedure

Important: This procedure assumes the Prisma II Chassis is mounted in a rack.

Note: Observe laser safety precautions. Refer to **Laser Safety** earlier in this guide.

Follow this procedure to make the optical cable connections for each module to be installed.

Connecting Optical Cables, Continued



CAUTION:

High power density exists on fiber when optical power is present. To avoid microscopic damage to fiber mating surfaces, turn off optical power before making or breaking optical connections.

1. Attach one end of the optical output cables to Optical Output 1 (port 2) and Optical Output 2 (port 1) located on the front of the Standard and Low Input Optical Switch.

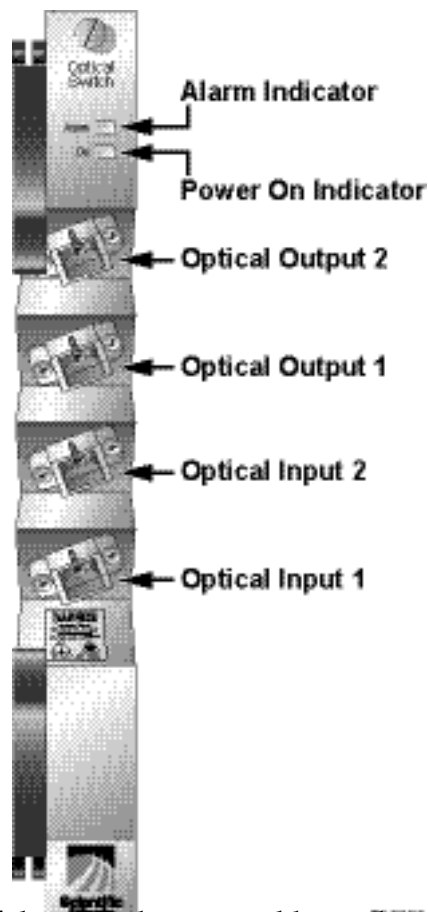

2. Route the other end of the optical output cables to the appropriate destinations.
3. Attach one end of the optical input cables to Optical Input 1 (port 4) and Optical Input 2 (port 3) located on the front of the Standard and Low Input Optical Switch.
4. Route the other end of the optical input cables to the appropriate sources.

Connecting the ICIM to Additional Chassis

Chassis-to-Chassis ICIM Connections

The Prisma II platform allows the ICIM to be located in one chassis and control application modules located in several other chassis. This communication “daisy-chain” can be enabled by connecting cables to the **ICIM IN** and **ICIM OUT** connectors located on the connector interface panel of the chassis. This connection is required if an ICIM in one chassis is to communicate with or control any application module located in a separate chassis.

Note: An ICIM can control a maximum of 140 modules. Depending on your application, this is typically 6 or 7 chassis to a rack. Do not exceed these limits.

ICIM IN and ICIM OUT Connectors

Every Prisma II Chassis has a DB9 **ICIM IN** and a DB9 **ICIM OUT** connector for the purpose of chassis-to-chassis ICIM connections. **ICIM OUT** is a male connector and **ICIM IN** is a female connector.



ICIM IN and ICIM OUT Cables

The cable required for both **ICIM IN** and **ICIM OUT** connections is a standard “off the shelf” serial extension cable, DB9 Female to DB9 Male. This cable can be purchased at your local computer store or from Cisco.

The Cisco part number for a 6-foot DB9 Female to DB9 Male serial extension cable is 180143. The connectors are a serial 9-pin D-shell (EIA 574/232).

ICIM IN and ICIM OUT Cable Connection Procedure

To make chassis-to-chassis **ICIM IN** and **ICIM OUT** connections, follow these steps.

1. Connect the serial extension cable from the **ICIM OUT** of the chassis containing the ICIM to the **ICIM IN** connector of the second chassis.
2. Connect a serial extension cable from the **ICIM OUT** of the second chassis to the **ICIM IN** of the third chassis.
3. Continue this “daisy-chain” connection until all chassis are connected.

Notes: All chassis connected in this “daisy-chain” must be powered and have a fan tray installed. A chassis that is connected but is either not powered, or does not have a fan tray installed, will cause faulty operation of the ICIM.

All chassis connected in this “daisy-chain” must have a unique chassis ID number.

Connecting the Chassis to the TNCS Server

Connecting a Prisma II Chassis to the TNCS Server Using the EM Connectors

Connecting the Prisma II Chassis to the TNCS server requires two special cable kits that are available from Cisco.

- The RS-485 cable kit, part number 735748, includes the following:
 - 4 ea. Breakout boxes
 - 4 ea. RS-485 cable assemblies (50')
 - 4 ea. Breakout box mounting brackets
 - 100 ea. 6-32 screws (1.25")
- The Prisma II cable kit, part number 738686, includes the following:
 - 4 ea. Prisma II cable assemblies

The RS-485 cable kit is used to communicate with the RS-485/422/TTL devices.

EM IN to TNCS Connection

To connect TNCS to a Prisma II Chassis, follow these steps.

1. Mount one of the breakout boxes (included in the RS-485 cable kit) in a rack location central to the appropriate Prisma II Chassis.



2. Connect a RS-485 cable assembly (included in the RS-485 cable kit) from the breakout box to the **RS-485 COM** port on the TNCS server.
3. Connect one Prisma II cable assembly (included in the Prisma II cable kit) from the breakout box to the **EM IN** port of each Prisma II Chassis containing an ICIM.

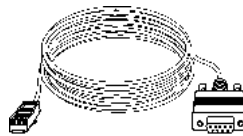

Note: As a general rule, it is recommended that the total number of ICIMs connected to any single COM port on the TNCS server be limited to four (4). However, you may connect more than four ICIMs per TNCS COM port as long as the total number of devices (modules) monitored by a single COM port does not exceed four-hundred (400) *and* the total number of devices monitored by any single ICIM does not exceed 140.

Connecting the Chassis to the TNCS Server, Continued

Using TNCS with Multiple Prisma II Chassis

All chassis within an ICIM's domain are connected in series via the ICIM IN/OUT connectors using standard "off the shelf" serial extension cable, DB9 Female to DB9 Male. Using the EM IN/OUT connectors, a chassis with an ICIM installed is connected to a breakout box as shown below. The breakout box is connected to the TNCS server with the cable included in the RS-485 cable kit.

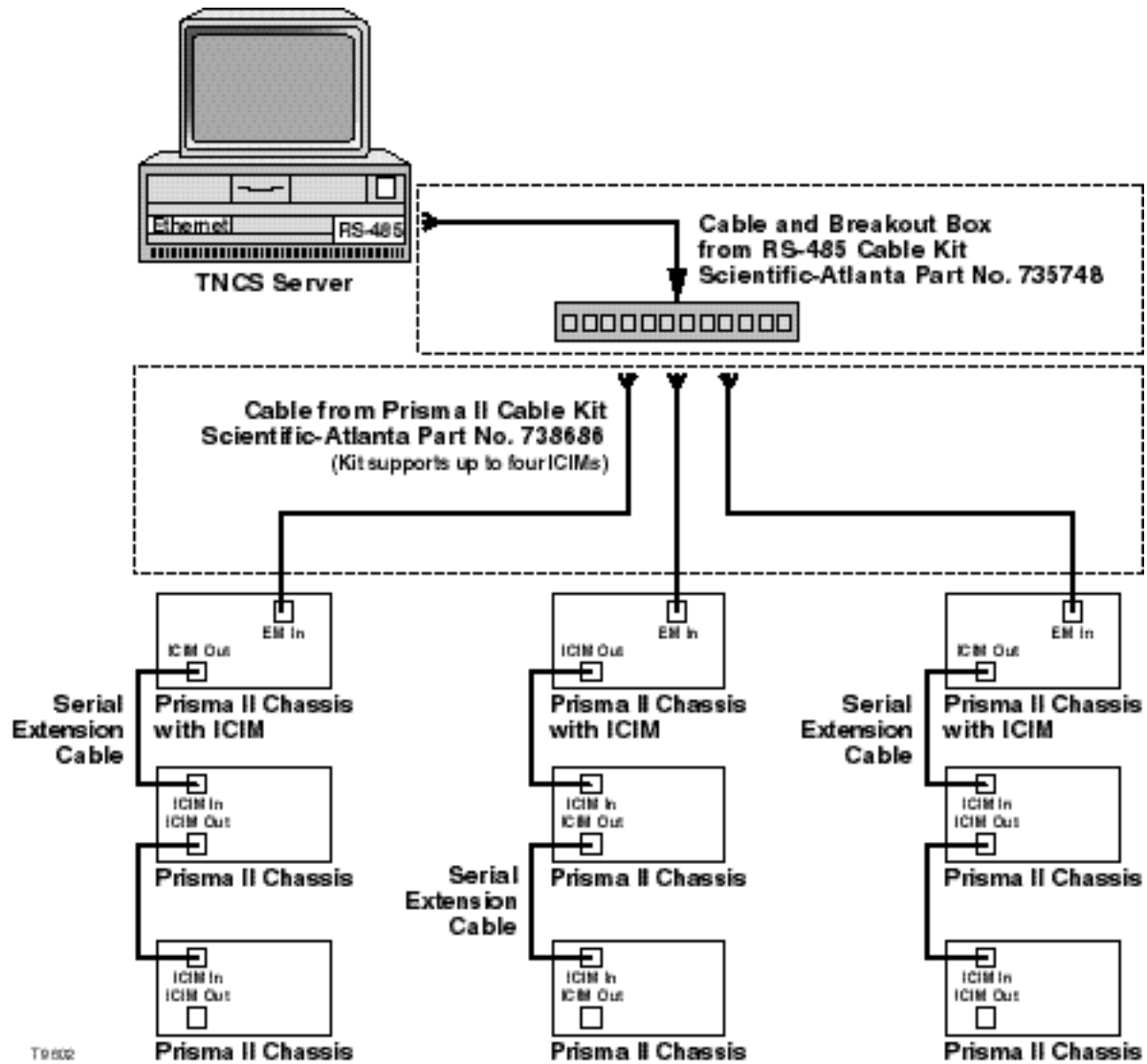

Chapter 3

Operation Using the ICIM

Overview

Introduction

The procedures in this chapter apply if you are using the Prisma II ICIM to configure and operate the Standard and Low Input Optical Switch.

Scope of This Chapter

Included in this chapter are descriptions of the ICIM front panel and the ICIM liquid crystal display (LCD), and detailed procedures on how to use the software menus to configure the optical switch.

In This Chapter

This chapter contains the following topics.

Topic	See Page
ICIM Introduction	3-2
The ICIM Front Panel	3-3
The ICIM Password	3-6
Operating the ICIM	3-13
Monitoring Operating Status Using the ICIM	3-17
Configuring the Optical Switch Using the ICIM	3-20
Checking Optical Switch Alarms Using the ICIM	3-23
Checking Manufacturing Data Using the ICIM	3-26
Using the ICIM to Save the Configuration	3-28
SNMP Configuration Capability	3-29
Community Names	3-33
Setting SNMP Trap Receiver Parameters	3-34
New SNMP Variables	3-35

ICIM Introduction

Laser Warning



WARNING:

Avoid damage to your eyes! Do not look into any optical connector while the system is active. Even if the unit is off, there may still be hazardous optical levels present.

ICIM Function

The ICIM functions as the module-user interface as well as the interface between the Prisma II modules and the Transmission Networks Control Systems (TNCS). The ICIM allows local module configuration and status monitoring for up to 140 modules located in multiple chassis. The ICIM features easy-to-use software that is navigated using the numeric keypad and the LCD display.

Important: Do not operate any Prisma II Chassis without a fan tray installed properly. If a fan tray is not installed in the Prisma II Chassis, the ICIM will not communicate with any of the modules in that chassis.

Important: All chassis connected in a “daisy-chain” must be powered and have a fan tray installed. A chassis that is connected but is either not powered, or does not have a fan tray installed will cause faulty operation of the ICIM.

Important: All chassis connected in this “daisy-chain” must have a unique chassis identification (I.D.) number.

ICIM Block Diagram

The ICIM is illustrated in the block diagram below.

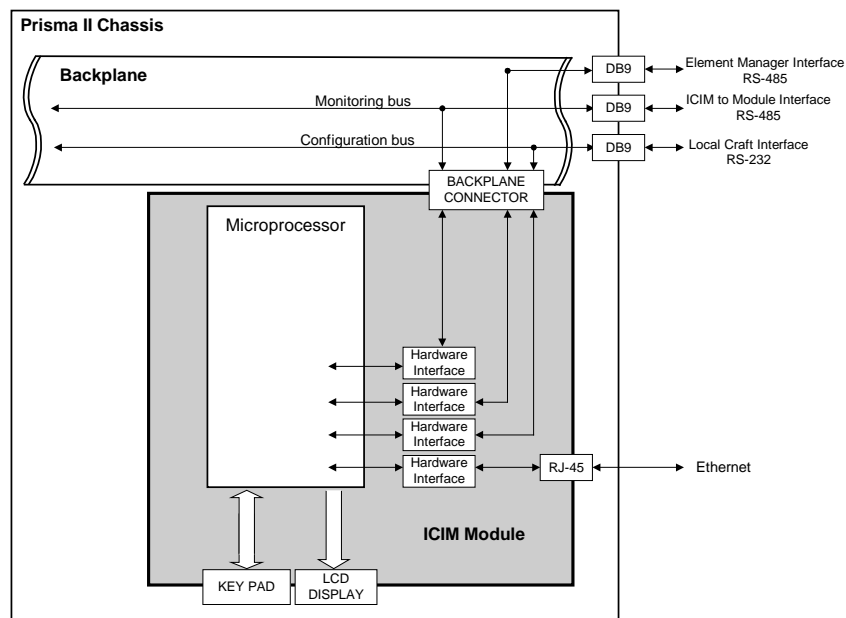

The ICIM Front Panel

ICIM Front Panel Illustration

The following illustration shows the front panel of the ICIM.

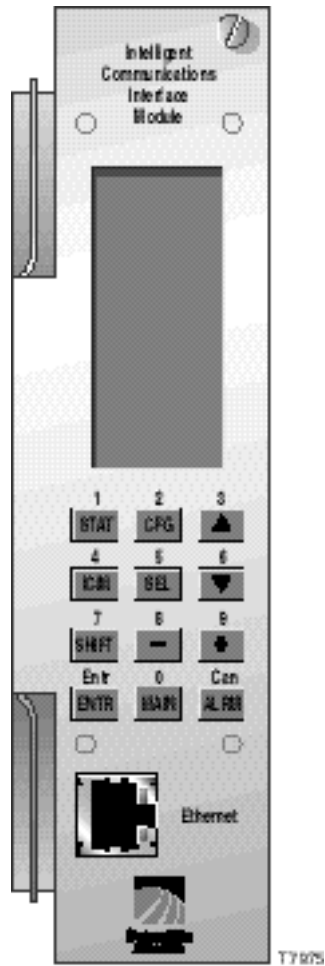

The ICIM Front Panel, Continued

ICIM Front Panel Features

Part	Function
LCD screen	Displays the ICIM menus, alarms, and status information.
12-key alphanumeric keypad	Used to navigate the ICIM's menus and configure the application modules.
Ethernet Connector	Directly connects the ICIM to a network (future release).

The ICIM LCD

The ICIM LCD is the operator's visual link to the ICIM software. When the ICIM is installed and powered up, the **MAIN** menu is displayed on the LCD. The following illustration shows the ICIM's **MAIN** menu.

MAIN

O f f l i n e

M o d u l e s
1 5

A l a r m s
0













S c r o l l

M o d u l e
S h e l f
S l o t

The ICIM Front Panel, Continued

The ICIM Keypad

The ICIM keypad has twelve keys that allow you to input and monitor operational parameters. The table below lists each key and a brief description of its function.

Key	Function
	Displays status information for the selected module
	Displays configuration information for the selected module
	Displays all of the parameters in alarm for a selected module
	Moves the menu selection area up. Also increases numerical readings of selected configuration parameters
	Moves the menu selection area down. Also decreases numerical readings of selected configuration parameters
	Selects the highlighted parameter
	Displays ICIM module information such as firmware version, serial number, and baud rate
	Shifts function of a key to the function or number label just above that key.
	Decreases numerical readings of selected configuration parameters
	Increases numerical readings of selected configuration parameters
	Enters input data (if valid)
	Exits the current menu and displays the MAIN ICIM menu

The ICIM Password

Introduction

The ICIM allows you to send configuration commands, to change alarm thresholds, and restore factory default settings in Prisma II modules. In order to ensure that no unauthorized changing of these parameters occurs, you have the option of using a password protection system. Password authorization only applies to the configurable parameters. Status and alarm information is always available on the ICIM regardless of password implementation.

Password Protection System

The table below shows the ICIM menu options available in the password protection system.

ICIM Menu Option	Description
User Psw	A user-settable password. <ul style="list-style-type: none">• Created, entered, and changed by the system operator(s)• Must be exactly eight digits, using only the 0-9 number keys
Change Psw	Changes an existing user password
Disable Psw	Disables the user password function
SA Psw	A service password that is used by Cisco personnel only

Important: If you only want to monitor status and alarm data, simply skip the password function when it appears on the ICIM menu. You can access all module status and alarm information without a password. However, once a user password is entered, you are required to enter it every time you want to set configurable parameters to any module controlled by that ICIM. See **Expired Password or Inactive Password Messages** and **Entering the User Password** that follow.

The ICIM Password, Continued

Accessing the Password Menu

The Password menu allows you to create, enter, change, or disable the user password. It also allows service personnel to use the Cisco (SA) password. To access the Password menu, follow the steps below.

1. Press the **ICIM** key.
2. Use the **▼** key to scroll down until **Password** is highlighted.
3. Press the **SEL** key. The Password menu is displayed. **User Psw** is highlighted.

MAI N	ICIM	ICIM	ICIM
-----	-----	-----	-----
Of f l i n e	Sh e l f 7	Sh e l f 7	Sh e l f 7
-----	S l o t 15	S l o t 15	S l o t 15
-----	-----	-----	-----
Mod u l e s	M f g D a t a	M f g D a t a	U s e r P s w
0	-----	-----	-----
A l a r m s	P a s s w o r d	P a s s w o r d	S A P s w
0	-----	-----	-----
-----	-----	-----	-----
S c r o l l	U p d a t e A d r	U p d a t e A d r	C h a n g e P s w
-----	-----	-----	-----
Mod u l e	-----	-----	D i s a b l e
S h e l f	-----	-----	P s w
S l o t	-----	-----	-----

Expired Password or Inactive Password Messages

The entry of a valid password allows changes to system parameters for a period of 10 minutes. If more than 10 minutes has passed since your last keystroke, and you attempt to make any changes to system parameters, the menu displays **Psw Expired**. If, after more than 10 minutes, you attempt to disable the password the menu displays **Failed, Password Not Active**. If either of these messages is displayed, you are required to re-enter the password. To re-enter the password, follow the procedure in the next section, **Entering the User Password**.

The ICIM Password, Continued

Entering the User Password

If you wish to use the user password feature, you must create and enter a password of exactly eight digits using only the 0-9 number keys. The password remains active for 10 minutes after your last keystroke. If you want to change configuration parameters after more than 10 minutes, you are required to re-enter your password.

Follow these steps to enter a user password.

1. Access the Password menu as shown earlier in **Accessing the Password Menu**.
2. Press the **SEL** key.

Result: The user password menu displays.

3. When **User Psw/Shift Off** displays, press the **SHIFT** key to display **Shift On** - then enter the eight digits of your password, using the 0-9 number keys.

If at any time you input a digit that is incorrect or you wish to change a digit, use the **CAN** (Cancel) function by pressing the **ALRM** key to delete that digit.

4. Press the **ENTER** key to enter the password.

Results:

- The ICIM updates the display to show if your password entry was accepted or rejected.
- If the entry was accepted, you are able to return to the MAIN menu.

The ICIM Password, Continued

5. If the password you entered is rejected, press the **SHIFT** key to return to the password menu, then re-enter an 8-digit password using only the 0-9 number keys. Press the **ENTER** key to input the password.

Reasons for a password to be rejected include:

- Entering more than eight digits for the password
- Pressing keys other than the 0-9 number keys
- Entering an incorrect password if a valid password has been entered



ICIM	ICIM	ICIM	ICIM
Shelf 0 Slot 15	Shelf 0 Slot 15	Shelf 0 Slot 15	Shelf 0 Slot 15
User Psw	User Psw	User Psw 1234****	User Psw 12345678
Shift Off	Shift On	Rejected Shift Off	Accepted Shift Off

The ICIM Password, Continued

Changing the User Password

If a user password has been entered, it may be changed. However, the current password must be active prior to changing it. If the current password has expired (more than 10 minutes have passed since your last keystroke), you must re-enter the current password before changing to a new one.

Follow these steps to change a user password.

1. Access the Password menu as shown in the procedure **Accessing the Password Menu**.
2. Use the  key to scroll down until **Change Psw** is highlighted.
3. Press the  key to select **Change Psw**.
4. When **Change Psw /Shift Off** displays, press the  key to display **Shift On** - then enter the eight digits of your new password, using the 0-9 number keys.

If at any time you input a digit that is incorrect or wish to change a digit, use the **CAN** (Cancel) function by pressing the  key to delete that digit.

5. Press the  key to input the new password.

Results:

- The ICIM updates the display to show if your password entry was accepted or rejected.
- If the entry was accepted, you are able to return to the MAIN menu.

The ICIM Password, Continued

6. If the new password you entered is rejected, press the **SHIFT** key to return to the password entry menu. Clear all digits using the **CAN** (Cancel) function, then re-enter an 8-digit password using only the 0-9 number keys. Press the **ENTER** key to input the password.

ICIM	ICIM	ICIM	ICIM
----- Shelf 7 Slot 15 ----- User Psw ----- SA Psw ----- Change Psw ----- Disable Psw	----- Shelf 7 Slot 15 ----- Change Psw ----- Shift Off	----- Shelf 7 Slot 15 ----- Change Psw ----- ***** ----- Shift On	----- Shelf 7 Slot 15 ----- Change Psw ----- 87654321 ----- Shift On

The ICIM Password, Continued

Disabling the User Password

If a user password has been entered, you may disable it at any time. However, the current password must be active prior to disabling it. If the current password has expired (more than 10 minutes have passed since your last keystroke), you must re-enter the current password before disabling it.

1. Press the **ICIM** key.
2. Use the **▼** key to scroll down until **Password** is highlighted.
3. Press the **SEL** key.
4. Use the **▼** key to scroll down until **Disable Psw** is highlighted.
5. Press the **SEL** key to select **Disable Psw**.
6. If the current password is active, the menu displays **Password Is Now Disabled**. You can now make changes to parameters without any password.
7. If the current password has expired (more than 10 minutes have passed since your last keystroke), the menu will display **Failed, Password Not Active**. You must re-enter the current password and then repeat this procedure.

ICIM	ICIM	ICIM
-----	-----	-----
Shelf 7	Shelf 7	Shelf 7
Slot 15	Slot 15	Slot 15
-----	-----	-----
User Psw	Enter Psw	Enter Psw
-----	8765****	87654321
SA Psw	-----	-----
-----	-----	-----
Change Psw	Password	Failed,
-----	Is Now	Password
Disable Psw	Disabled	Not Active
-----	-----	-----
	Shift Off	Shift Off

Operating the ICIM

Using the ICIM

Once the module is installed as described in Chapter 2, it runs without the aid of an operator. Unless alarms are generated or your system configuration changes, you should not need to make any adjustments to the module beyond the initial setup.

Accessing the ICIM LCD Contrast

To access the ICIM LCD contrast control from the MAIN menu, press the **ICIM** key. Use the **+** key to increase or the **-** key to decrease ICIM display contrast.

The MAIN Menu

A few seconds after power-up, the MAIN menu (shown below) is displayed. Press the **SEL** key to select the specific option.

Display	Description
Offline	Indicates TNCS communication status with the ICIM.
Modules	Indicates the number of modules in the ICIM domain.
Alarms	Displays the number of modules that are in alarm. Selecting this option allows scrolling through all modules in alarm condition.
Scroll	Allows scrolling through all modules in the ICIM domain.
Module Shelf Slot	Allows selection of any specific module in the ICIM domain.

MAIN

Offline

Modules
15

Alarms
0

Scroll

Module
Shelf
Slot

Operating the ICIM, Continued

Prisma II ICIM Menu

To display the ICIM menu, press the **ICIM** key. The ICIM menu (shown below) is displayed. Press the **SEL** key to select the specific option.

Display	Description
Shelf Slot	Displays the location of the ICIM module.
Mfg Data	Displays manufacturing data about the ICIM.
Password	Allows you to enter, change, or disable a system password. See Using the ICIM Password earlier in this chapter.
Update Adr	If the Chassis ID number switch has been changed, you must highlight the Update Adr menu and press the SEL key for the ICIM to recognize the change.

ICIM	ICIM	ICIM
----- Shelf 7 Slot 15 ----- Mfg Data ----- Password ----- Update Adr	----- Shelf 7 Slot 15 ----- Mfg Data ----- Password ----- Update Adr	----- Shelf 7 Slot 15 ----- Mfg Data ----- Password ----- Update Adr

Operating the ICIM, Continued

Prisma II MAIN Menu and ICIM Menu Structure

Pressing the **MAIN** key initiates the MAIN software menu. Pressing the **ICIM** key initiates the ICIM software menu. The MAIN and ICIM software structures are shown below.

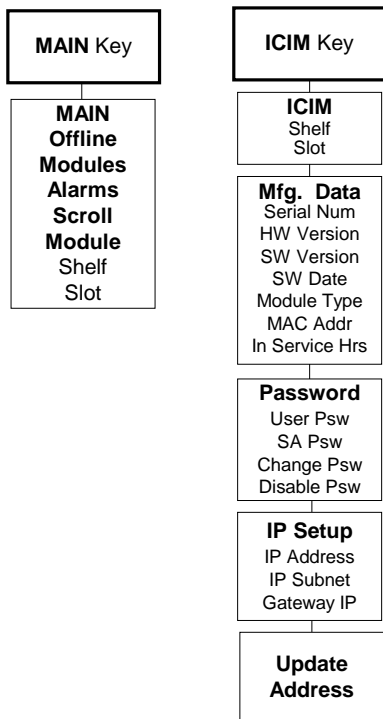

Operating the ICIM, Continued

Prisma II Optical Switch Software Menu Structure

From the MAIN or SCROLL menus, you can navigate to the optical switch MODULE menu. From the MODULE menu, press the **STAT**, **CFG**, or **ALRM** key to display the desired parameter menu.

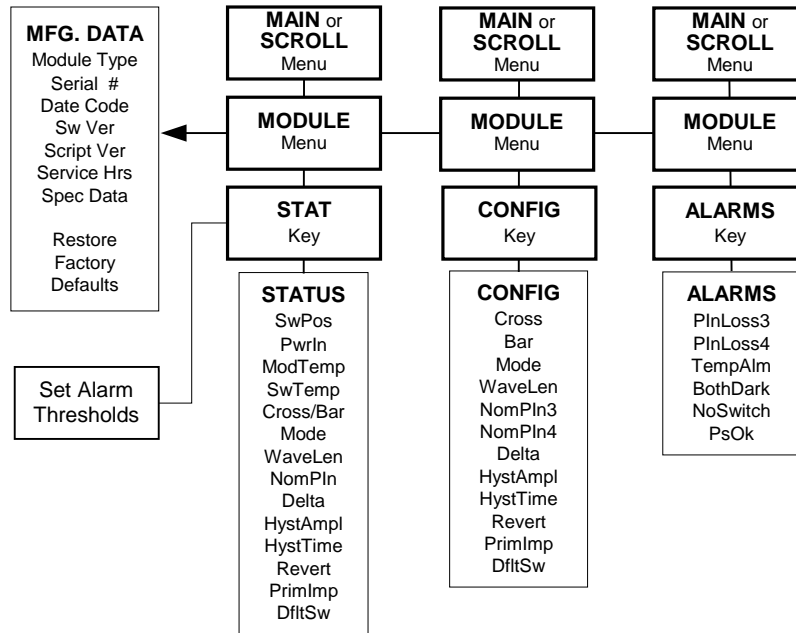

Monitoring Operating Status Using the ICIM

Checking Operating Status

Using the ICIM, you can check the status of all operating parameters of this module. All status information is displayed on the ICIM LCD.

Follow these steps to monitor operating parameters.

1. At the MAIN menu, press the key to highlight the **Shelf** and **Slot** fields.
2. Press the key to address the **Shelf** number. Then press the key or the key to scroll to the number of the desired shelf.
3. Press the key.
Result: The **Slot** field is highlighted.
4. Press the key or the key to scroll to the number of the desired slot.
5. Press the key.
Result: The **MODULE** menu displays on the ICIM.
6. Press the key.
7. Press the key or the key to scroll through the monitored parameters until you find the parameter of interest.
8. Check the status of the desired parameter or select other parameters to monitor. When finished, press the key to return to the **MAIN** menu.

Monitoring Operating Status Using the ICIM, Continued

Monitored Parameters

The table below describes the monitored operating parameters for this module.

Parameter	Function	Standard Typical Value	Low Input Typical Value
SwPos	Reads switch position	Bar	Bar
PwrIn3	Optical input power on port 3	0 dBm	-25 dBm
PwrIn4	Optical input power on port 4	0 dBm	-25 dBm
ModTemp	Module temperature	+25°C	+25°C
SwTemp	Switch temperature	+25°C	+25°C
Cross	Cross position control	(always) False	(always) False
Bar	Bar position control	(always) False	(always) False
Mode	Auto or manual mode	Auto	Auto
WaveLen	Wavelength of optical input for both inputs	1550 nm	1550 nm
NomPIn3	Nominal input power at port 3	3.0 dBm	-28.0 dBm
NomPIn4	Nominal input power at port 4	3.0 dBm	-28.0 dBm
Delta	The value relative to nominal below which the input optical power must fall for the switch to operate. Auto mode only.	6.00 dB	2.00 dB
HystAmpl	Hysteresis Amplitude: The value above which the input optical power must rise for the switch to begin the hysteresis timer.	3.0 dB	3.0 dB
HystTime	Hysteresis Time: Length of time that primary optical power must remain above the restore threshold before switch will revert to primary position. Only applies if Revert is True.	1.0 sec	1.0 sec
Revert	Allows switch to revert to primary position after optical power is restored.	Auto	Auto
PrimeInp	Primary input port	Port_4	Port_4
DfltSw	The default switch position	Bar	Bar

Monitoring Operating Status Using the ICIM, Continued

STATUS Menus

Press the **STAT** key to select the **STATUS** menu. Typical **STATUS** menus are shown below.

STATUS	
Shelf	5
Slot	10

Optical Switch	

Cross	

PwrIn3	-13.0 dBm
▲ ▼	

STATUS	
Shelf	5
Slot	10

Optical Switch	

PwrIn4	-13.0 dBm

ModTemp	24.0 degC
▲ ▼	

STATUS	
Shelf	5
Slot	10

Optical Switch	

SwTemp	25.63degC

Cross	False
▲ ▼	

STATUS	
Shelf	5
Slot	10

Optical Switch	

Bar	False

Mode	Auto
▲ ▼	

STATUS	
Shelf	5
Slot	10

Optical Switch	

WaveLen	1550nm

NomPIn3	0 dBm
▲ ▼	

STATUS	
Shelf	5
Slot	10

Optical Switch	

NomPIn4	0 dBm

Delta	6.00 dB
▲ ▼	

STATUS	
Shelf	5
Slot	10

Optical Switch	

HystAmpl	3.00 dB

HystTime	1.000 sec
▲ ▼	

STATUS	
Shelf	5
Slot	10

Optical Switch	

Revert	Auto

PrimeInp	Port_4
▲ ▼	

Configuring the Optical Switch Using the ICIM

Configuring Parameters

Using the ICIM, you can configure the parameters listed below. A list of configurable parameters and CONFIG menus follow these procedures.

Follow these steps to configure parameters.

1. From the **MAIN** menu, press the key to highlight the **Shelf** and **Slot** fields.
2. Press the key to address the **Shelf** number. Then press the key or the key to scroll to the number of the desired shelf.
3. Press the key.
Result: The **Slot** field is highlighted.
4. Press the key or the keys to scroll to the number of the desired slot.
5. Press the key.
Result: The **MODULE** menu displays on the ICIM.
6. To configure the module, press the key.
7. Press the key or the key to scroll through the configurable controls until you find the parameter of interest.
8. Press the key to select the highlighted control.
9. Press the key or the key to activate or change the value of the selected control.
10. Press the key to save the changes and return to the **MAIN** menu.

Configuring the Optical Switch Using the ICIM, Continued

Configurable Parameters



Configurable parameters for the Standard and Low Input Optical Switch are listed below.

Parameter	Function	Standard		Low Input	
		Values	Default	Values	Default
Cross	If True, the switch to change to the Cross position. Reset to False after < 50 ms. Manual mode command.	False True	False	False True	False
Bar	If True, the switch to change to the Bar position. Reset to False after < 50 ms. Manual mode command.	False True	False	False True	False
Mode	Selects automatic or manual mode.	Manual Auto	Auto	Manual Auto	Auto
WaveLen	Selects the wavelength of optical input for both inputs.	1310 nm 1550 nm	1550 nm	1310 nm 1550 nm	1550 nm
NomPIn3	Nominal input optical power at port 3, in dBm	1310 nm -13.0 dBm to 13.0 dBm, increments of 0.1 dBm	-3.0 dBm	1310 nm -30.0 dBm to 0 dBm, increments of 0.1 dBm	-28.0 dBm
NomPIn4	Nominal input optical power at port 4, in dBm	1550 nm -13.0 dBm to 18.0 dBm, increments of 0.1 dBm		1550 nm -30.0 dBm to 0 dBm, increments of 0.1 dBm	
Switch Threshold Delta	Delta: the value (in dB relative to nominal) below which the input optical power must fall for the switch to operate. Auto mode only.	1.0 to 10.0 dB, increments of 0.1 dB	6.0 dB	1.0 to 10.0dB, increments of 0.1dB	2.0 dB
HystAmpl	Hysteresis Amplitude: the value (in dB relative to switching threshold) above which the input optical power must rise for the switch to begin the hysteresis timer before resoring original switch position. Only applies if Revert is Auto. Auto mode only.	0.5 to 9.5 dB, increments of 0.1 dB	3.0 dB	0.5 to 9.5dB, increments of 0.1	3.0 dB
HystTime	Hysteresis Time. Auto mode only. Length of time that primary optical power must remain above the restore threshold before switch will revert to primary position. Only applies if Revert is Auto.	Integer in seconds, between 0 and 600 (0 to 10 minutes)	1 sec	Integer in seconds, between 0 and 600 (0 to 10 minutes)	1 sec

Configuring the Optical Switch Using the ICIM, Continued

Parameter	Function	Standard		Low Input	
		Values	Default	Values	Default
Revert	Auto mode only. Allows switch to revert to primary position after optical power is restored. In Manual, switch will remain in backup position.	Manual Auto	Auto	Manual Auto	Auto
PrimInp	Selects the primary optical input. For auto mode triggering.	Port 3 Port 4	Port 4	Port 3 Port 4	Port 4
DfltSw	Selects the Normal switch position. Auto mode only.	Bar or Cross	Bar	Bar or Cross	Bar

CONFIG Menus

When the **CONFIG** menu is selected, the **Shelf** number field is highlighted. The shelf and slot number fields may only be incremented with the  key or the  key. The  key highlights the **Slot** number field. Once you exit the slot field, the up/down arrows will scroll through the parameters that are specific to this module. Sample **CONFIG** menus are shown below.

```

CONF IG
-----
Shelf   5
Slot   10
-----

Optical
Switch
-----

Cross
Bar
Mode
WaveLen
NomPIn3
▲ ▼
    
```

```

CONF IG
-----
Shelf   5
Slot   10
-----

Optical
Switch
-----

NomPIn4
Delta
HystAmpI
HystTime
Revert
▲ ▼
    
```

```

CONF IG
-----
Shelf   5
Slot   10
-----

Optical
Switch
-----

Cross
PrimInp
DfltSw
▲ ▼
    
```

```

CONF IG
-----
Shelf   5
Slot   10
-----

Optical
Switch
-----

Cross
False
-----

Bar
False
▲ ▼
    
```

Checking Optical Switch Alarms Using the ICIM

Checking Alarms

If the ALARM LED on the front panel is blinking, a minor alarm condition is indicated. If the ALARM LED on the front panel is illuminated, a critical alarm condition is indicated.

Alarms fall into one of the following categories.

- Major low
- Minor low
- Minor high
- Major high

Follow these steps to check alarm conditions.

1. From the MAIN menu, press the key to highlight the **Shelf** and **Slot** fields.
2. Press the key to address the **Shelf** number. Then press the key or the keys to scroll to the number of the desired shelf.
3. Press the key.
Result: The **Slot** field is highlighted.
4. Press the key or the key to Scroll to the number of the desired slot.
5. Press the key.
Result: The **MODULE** menu displays on the ICIM.
6. Press the key.
Result: Module alarm conditions display.
7. Use the key or the key to scroll through alarm conditions until the desired alarm is displayed.
8. Monitor the alarm condition(s). Take appropriate action. Verify that all settings and thresholds relating to the alarm indication are set correctly to rule out an unintended alarm.
9. When finished, press the key to return to the MAIN menu.



Checking Optical Switch Alarms Using the ICIM, Continued

User Alarm Data Display

The user alarm data for this module is shown below.

Alarm Display	Function	Possible Cause
PInLoss3	Detects loss of light at input 3	Port 3 is dark
PInLoss4	Detects loss of light at input 4	Port 4 is dark
TempAlm	Module temperature is above high threshold or below low threshold	Temp Alarm

User Alarm Menus

When a module's **ALARM** menu is selected, press the  key or the  key to scroll through alarms. Some typical user alarm menus are shown below.

ALARMS	
Shelf	5
Slot	10
Optical Switch	
PInLoss3 Fault	
▲ ▼	

ALARMS	
Shelf	5
Slot	10
Optical Switch	
PInLoss4 Fault	
▲ ▼	

ALARMS	
Shelf	5
Slot	10
Optical Switch	
TempAlm Fault	
▲ ▼	

Checking Optical Switch Alarms Using the ICIM, Continued



Module Alarm Data

Module alarms represent a serious condition has occurred in the system. If a module alarm occurs, the module will stop operating until the alarm is cleared.

Module alarms are set at the factory and are not configurable by the user. The module alarm data for this module is shown below.

Alarm Display	Function	Possible Cause
BothDark	Detects loss of light at both inputs	Both inputs are dark
NoSwitch	Detects failure of switch	Switch failure
PsOk	Status of voltage	Voltage acceptable

Module Alarm Menus

When a module's **ALARM** menu is selected, press the  key or the  key to scroll through alarms. Some typical module alarm menus are shown below.

ALARMS	
Shelf	5
Slot	10
Optical Switch	
BothDark Fault	
▲ ▼	

ALARMS	
Shelf	5
Slot	10
Optical Switch	
NoSwitch Fault	
▲ ▼	

ALARMS	
Shelf	5
Slot	10
Optical Switch	
PsOk Fault	
▲ ▼	

Checking Manufacturing Data Using the ICIM

Checking Manufacturing Data

The Manufacturing Data information can be displayed on the ICIM menu.

Follow these steps to access the module's manufacturing data.

1. From the MAIN menu, press the key to highlight the **Shelf** and **Slot** fields.
2. Press the key to address the **Shelf** number. Then press the key or the key to scroll to the number of the desired shelf.
3. Press the key.

Result: The **Slot** field is highlighted.

4. Press the key or the key to scroll to the number of the desired slot.
5. Press the key. The MODULE menu for this module will be selected, as shown on the left below. Press the key to enter the start of the manufacturing data screens, as shown on the right below.

MODULE	MFG. DATA
Shelf 5	Shelf 5
Slot 10	Slot 10
Optical Switch	Optical Switch
Alarms 1	Module Type
Mfg. Data	4002
▲ ▼	▲ ▼

6. The or keys allow you to scroll through the manufacturing data.



Checking Manufacturing Data Using the ICIM, Continued

Manufacturing Data Display

The table below describes the manufacturing data available for this module.

Manufacturing Data	Standard Typical Values	Low Input Typical Values
Module Type	4000	4002
Serial #	!ABCDEFGF	!ABCDEFGF
Date Code	B01	B01
Sw Ver (Software Version)	CCB610	CCB610
Script Ver (Script Version)	7	7
In Service Hours	1	1
Spec Data	Special data	Special data
Restore Factory Defaults	Restores the module's factory default configuration settings.	Restores the module's factory default configuration settings.

MFG. DATA Menus

When the **MFG. DATA** menu is selected, the  key or the  key allows you to scroll through the manufacturing parameters specific to this module. Sample **MFG. DATA** menus are show below.

MFG. DATA ----- Shelf 5 Slot 10 ----- Optical Switch ----- Module Type 5 000 ▲ ▼	MFG. DATA ----- Shelf 5 Slot 10 ----- Optical Switch ----- Serial # AAYCUA Date Code B01 ▲ ▼	MFG. DATA ----- Shelf 5 Slot 10 ----- Optical Switch ----- Sw Rev CCB610 Script Ver 7 ▲ ▼	MFG. DATA ----- Shelf 5 Slot 10 ----- Optical Switch ----- In Service Hours 1 ▲ ▼
--	---	--	---

Using the ICIM to Save the Configuration

Saving the Current Configuration

To save the current module configuration, follow these steps after every change.

1. After you have changed a parameter or entered data, press the **ENTER** key to save the changes and return to the MAIN menu.
2. If you do not save your changes for two minutes, or if you press the **SHIFT** **CAN** keys at the same time, changes are aborted and the display returns to the MAIN menu.

Configuration Complete

Once you have configured this module to your system's specifications using the ICIM and no alarms are indicated, no further action is necessary. The module operates without further input. Alarms, changes in operating parameters, electrical power fluctuations, or changes in system design may be cause for additional action.

SNMP Configuration Capability

Introduction

The IP Setup menu item in the ICIM menu allows you to enter an IP address, IP subnet, and gateway IP in order to configure the ICIM for remote status monitoring and control by a Simple Network Management Protocol (SNMP) network management system.

Note: Contact Cisco Services for MIB files.

SNMP Considerations

The following items should be considered when implementing SNMP:

- The SNMP connection is made through the Ethernet port on the front of the ICIM. (Use 10baseT cable with an RJ-45 connector.)
- The Network Management System (NMS) must be installed behind a firewall to prevent any ill-intentioned persons with an SNMP manager from accessing, and tampering with, the ICIM.
- When the ICIM has to handle excessive SNMP traffic, it will respond slowly to both SNMP control and front panel input. If this occurs, reduce the update rate of the SNMP manager.

Important: If a HDRX chassis is set to chassis ID 41, the ICIM will not detect receiver 9 in that chassis.

Basic SNMP Setup

Refer to your SNMP manager documentation and/or Management Information Base (MIB) information for instructions on implementing SNMP. Before you can use and reconfigure SNMP services, you need to know the community names in your network and the IP addresses or computer names for SNMP management hosts that traps are sent to.

Setting Up the IP Configuration Parameters for SNMP Support

Follow these steps to set up the IP configuration parameters.

1. Press the ICIM key.

Result: The ICIM menu displays.

2. Select the **Password** menu and enter the User Password.

Result: The ICIM allows configuration changes for the next 10 minutes.

Note: Refer to your specific hardware Installation and Operation Guide for more information on using, entering, or changing the ICIM user password.

SNMP Configuration Capability, Continued

3. Press the key.

Result: The ICIM menu displays.

4. Use the key to scroll down until **IP Setup** is highlighted.
5. Press the key.

```
      I C I M
-----
Shelf      7
Slot      15
-----
IP Address
172.18.9
.227
IP Subnet
255.255
.255.0
Gateway IP
172.18.9
.254
```

Result: The IP Setup menu displays, as shown above.

6. Use the or keys to scroll to and highlight the desired configuration parameter; IP Address, IP Subnet, or Gateway IP.

SNMP Configuration Capability, Continued

7. Press the **SEL** key.

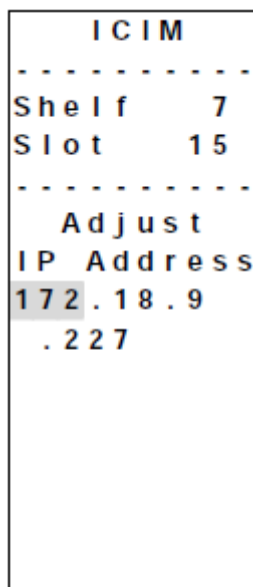

Result: The Adjust menu for the selected IP parameter displays and the first segment of the address is highlighted.

Note: The example above shows the IP Address parameter Adjust menu. The Adjust menus for IP Subnet and Gateway IP are similar.

8. Enter the correct numbers for the first segment of the address.

Notes: One of two methods can be used to enter the numbers, as follows:

- Press the **+** or **-** keys to increase/decrease the number to set value.
- Press the **SHIFT** key to change to the numeric entry mode. (“Numlock On” displays on the front panel LCD.) Then enter the exact number using the number keys on the 12-key numeric keypad.

9. Press the **ENTR** key to accept your entry and move to the next address segment to the right. (You can also use the **▼** or **▲** keys to move to the address segment of your choice.)

Note: If you are using the numeric entry mode, the cursor moves to the next address segment to the right automatically after you enter the last digit of the current address segment.

10. Repeat steps 8 and 9 until all address segments are entered.

Result: After you enter the last address segment and press the Enter key, the system returns to the IP Setup menu.

SNMP Configuration Capability, Continued

11. Repeat steps 6 through 10 for each IP Setup parameter that you need to enter.
12. Restart the ICIM.

Important: IP Setup parameters do not take effect until the ICIM is restarted.

Restarting the ICIM

Follow these steps to restart the ICIM.

1. Unscrew the captive screw near the top right-hand corner of the ICIM.
2. Unlock the top and bottom ejector levers near the left-hand side of the ICIM.
3. Pull the ejector levers out and away from the front panel to disconnect the ICIM from the chassis backplane connector.
4. Pull the ICIM at least 1.5 inches (3.81 cm) out from the front of the chassis to ensure that it is fully separated from the chassis backplane connector.
5. Reinsert the ICIM into the chassis until the ejector levers insert into their respective slots in the chassis.
6. Push the ejector levers in and flat against the ICIM front panel to reconnect the ICIM to the backplane connector until the ejector levers lock in place.
7. Screw in the captive screw to secure the ICIM in the chassis.

Community Names

Expected Community Names

The community name provides primitive security and context checking for both agents and managers that request and initiate trap operations. An agent does not accept a request from a manager outside the community.

Community names that ICIM expects are:

Read Community	public
Read/Write Community	private
Trap Community	SNMP_trap

Setting SNMP Trap Receiver Parameters

Introduction

Using the SNMP trap receiver parameters, you can specify up to five IP addresses that traps will be sent to. You can also specify what events will result in a trap being sent to the network management systems at these IP addresses. The Cold Start trap will always be sent to all network management systems. The Authentication Failure trap will also be sent to all trap receivers if the `snmpEnableAuthenTraps` is set to "Enabled".

You can specify which enterprise specific traps are sent to each trap receiver by setting variables in the `P2TrapRecv` table.

Set Traps in P2TrapRecvEntry

Entries to the `P2TrapRecvEntry` file can be made to send the trap information to a trap handler. The SNMP agent automatically sends an alert when the value of an object changes or exceeds a predefined threshold.

Follow these steps to set traps for a specific IP address.

1. On an SNMP manager, go to the `P2TrapRecvEntry` table.
2. Type the IP address that you want the trap sent.
3. Select **Enable** from the drop-down list.

Result: The new IP address is enabled and traps are sent to this IP address. Any changes are immediately stored to the EEPROM so the changes are not lost if power is lost or the ICIM is reset.

New SNMP Variables

Introduction

Supporting traps requires additional data available through SNMP. This additional data may be useful even if not using traps.

SNMP is the only way this additional data can be accessed. It cannot be accessed through the ICIM front panel or an SMC interface.

Table of Inserted Modules

This table is named p2InsertModuleTable. This table contains a list of modules that have been inserted since the last time the ICIM was reset or told to update the chassis ID for all modules. It does not include modules found when the initial search for modules is performed.

The modules are displayed in chronological order with the most recently inserted module always being in index position 1. If the number of modules inserted exceeds the capacity of the table, the oldest entries are deleted.

This table only contains the chassis and slot ID for a detected module. It is necessary to look at the other tables for more information.

Each row of this table is made up of the following variables:

p2InsertModuleIndex	The index for this table. The most recently inserted module is always in index position 1.
p2InsertModuleChassisID	The chassis ID number of the new module.
p2InsertModuleSlotID	The slot ID number of the new module.

Table of Removed Modules

This table is named p2RemoveModuleTable. This table contains a list of modules that have been removed since the last time the ICIM was reset or told to update the chassis ID for all modules.

The modules are displayed in chronological order with the most recently removed module always being in index position 1. If the number of modules removed exceeds the capacity of the table, the oldest entries are deleted.

New SNMP Variables, Continued

If a module is removed before the PNP data is read in the type, name and serial number is blank.

Each row of this table is made up of the following variables:

p2RemoveModuleIndex	The index for this table. The most recently removed module is always in index position 1.
p2RemoveModuleChassisID	The chassis ID number of the removed module.
p2RemoveModuleSlotID	The slot ID number of the removed module.
p2RemoveModuleName	The name of the removed module. This is the name is from the PNP data for this module and matches what the ICIM and SNMP display as the name. TNCS and LCI may use a different name.
p2RemoveModuleType	The TNCS type number of the removed module. This number uniquely identifies every type of module.
p2RemoveModuleSerialNum	The serial number of the removed module. This information is needed to determine if a module has been replaced with one that is the same type.

Previous IP Address

This variable is named p2PreviousIP. When the IP of the ICIM is changed using the front panel, this variable returns the previous ICIM IP address. It returns 0.0.0.0 until the IP address of the ICIM is changed for the first time.

Chapter 4

Operation Using LCI

Overview

Introduction

The installation steps and procedures in this chapter apply if you are using the Local Craft Interface (LCI) to operate the Standard and Low Input Optical Switch.

Scope of This Chapter

Included in this chapter are LCI installation instructions and detailed descriptions of how to use LCI to view and modify information for the optical switch.

In This Chapter

This chapter contains the following topics.

Topic	See Page
LCI Introduction	4-2
System Requirements	4-3
Installing LCI	4-4
Connecting Your Computer to the Chassis	4-7
Starting LCI	4-8
LCI Module Tree Overview	4-9
Accessing the Module Details Window	4-11
Checking the Operating Status	4-18
Configuring the Optical Switch	4-20
Checking Optical Switch Alarms	4-24
Modifying Optical Switch Alarm Limits	4-26
Checking Manufacturing Data	4-28



WARNING:

Avoid damage to your eyes! Do not look into any optical connector while the system is active. Even if the unit is off, there may still be hazardous optical levels present.

LCI Introduction

LCI Function

LCI is software that functions as a user interface for the Prisma II platform. LCI is installed on a computer, which is then connected to a Prisma II Chassis. Using LCI, you can configure and monitor the modules in the chassis the computer is connected to.

Important: Do not operate any Prisma II Chassis without a fan tray installed. If a fan tray is not installed in the Prisma II Chassis, the LCI will not communicate with the modules in that chassis.

System Requirements

Introduction

You will need the following computer software and hardware to run LCI.

Computer Requirements

- Pentium II 300 MHz processor or equivalent
- 128 MB RAM
- 10 MB available hard drive space
- 1.44 MB floppy drive
- CD-ROM Drive
- Windows 95 or later operating system software

Connecting the PC to the Prisma II Chassis

The required cable is a standard “off the shelf” DB9 Female to DB9 Male serial extension cable. The connectors are a serial 9-pin D-shell (EIA 574/232).

The Cisco part number for a six-foot DB-9-Female-to-DB-9-Male extension cable is 180143.

Installing LCI

Introduction

This section describes how to install your LCI software.

Installing the LCI Software

Follow these steps to install the LCI software.

1. Close all programs that are running on your computer.
2. Insert the LCI CD-ROM into your CD-ROM drive.

Results:

- The LCI software installation program starts automatically. If the installation program does not start automatically, open Windows Explorer and double-click the file **setup.exe** on the LCI CD-ROM.
- The Welcome screen displays.

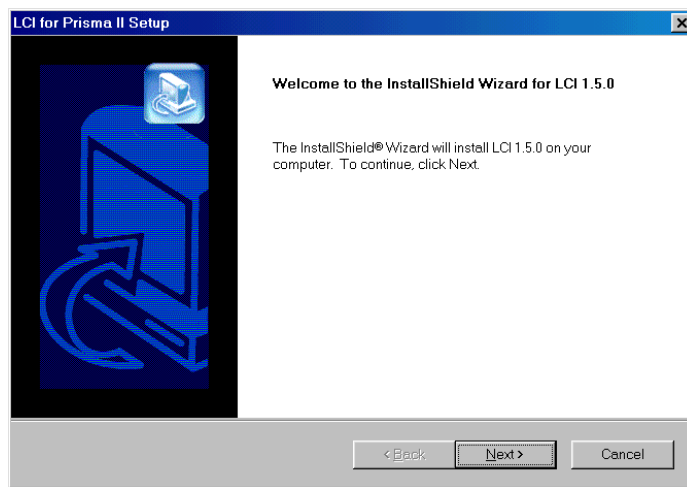

Installing LCI, Continued

3. Click **Next**.

Result: The License Agreement screen displays.

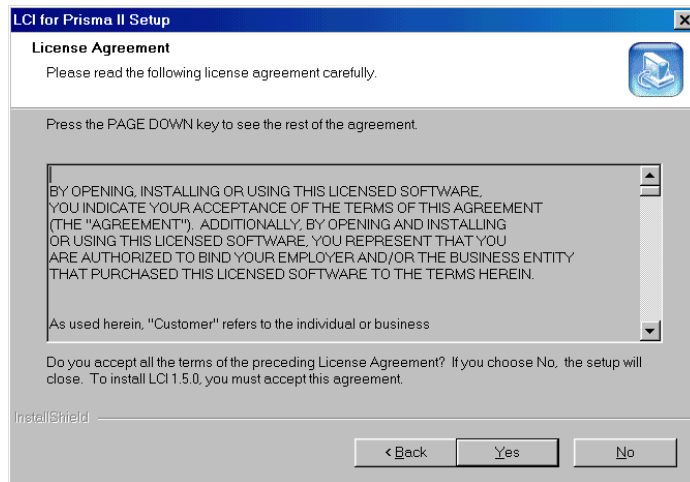

4. Click **Yes** if you accept the license agreement.

Result: The **License Agreement** dialog box displays.

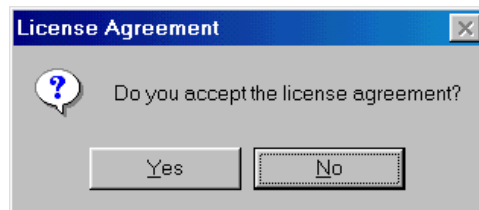

5. Click **Yes**.

Result: The Destination Folder window displays.

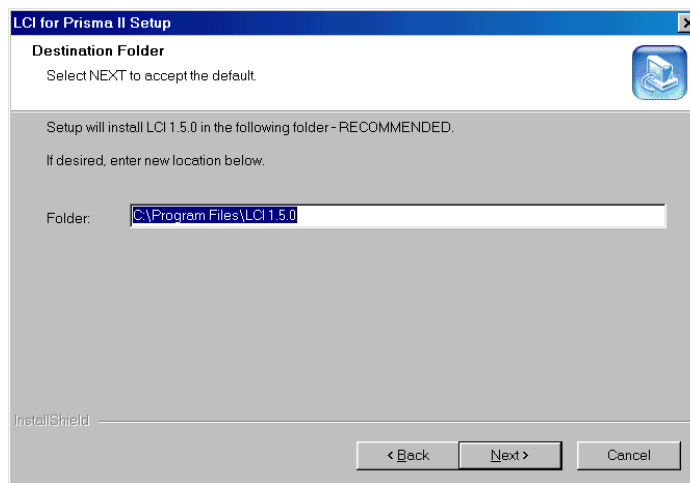

Installing LCI, Continued

6. Do you want to install the LCI software in the folder displayed in the **Folder** box?
 - If **yes**, click **Next** to begin the installation, and proceed to step 9.
 - If **no**, proceed to step 7.
7. To specify where you want the LCI software to be installed, type the path in the **Folder** box.
8. Click **Next** to begin the installation.

Result: The last installation wizard window displays after the installation is complete.

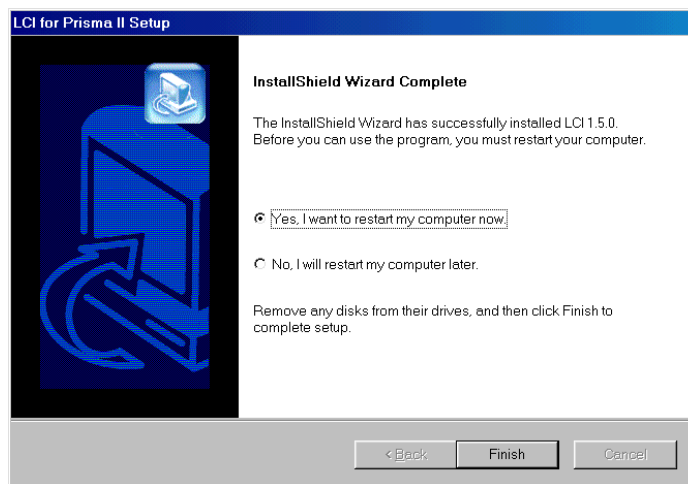

9. Before you can use the LCI software, you must restart your computer. Choose whether to restart your computer now or later by selecting the appropriate option button.
10. Click **Finish**. After your computer is restarted, you can use the LCI software.

Connecting Your Computer to the Chassis

Introduction

Before you start LCI, you must first connect your computer to the chassis that contains the module(s) you want to check.

Important: LCI communicates only with those modules located in the chassis your computer is attached to. To check other modules, you must connect your computer to the chassis they are located in.

Connecting to the Chassis

Follow these steps to connect your computer to the chassis.

1. Plug one end of a nine-pin serial extension cable into your computer.
2. Plug the other end of the cable into the LCI port. This port is labeled “Local Craft Interface”.

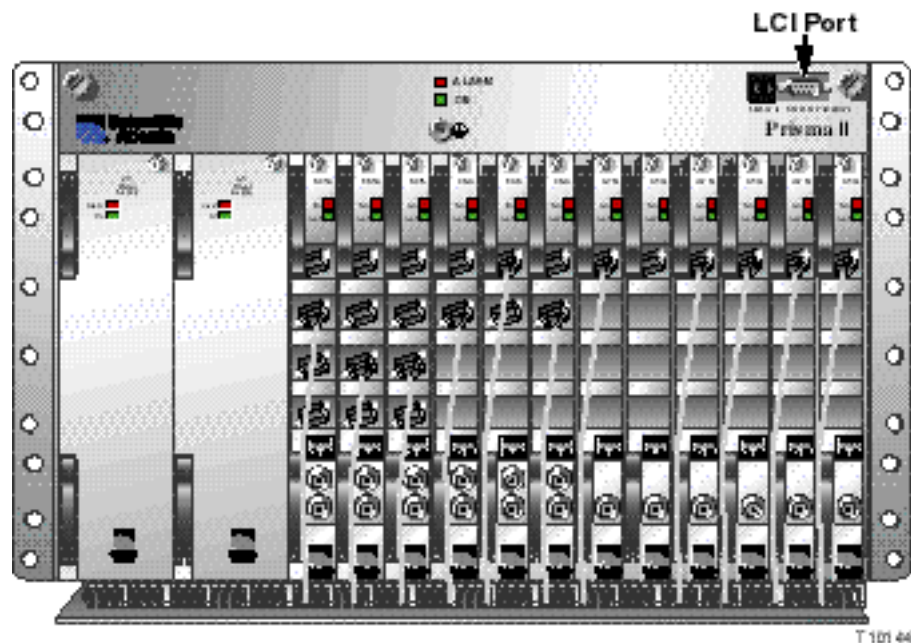

T 101 44

Starting LCI

Introduction

When LCI is started, it polls the module(s) located in the chassis your computer is attached to. For each module it finds, LCI does the following:

- Represents the module in the module tree of the main LCI window
- Makes the polling information available so you can check and configure various parameters

Important: Your computer must be connected to the chassis before you start LCI. For instructions, refer to **Connecting Your Computer to the Chassis** earlier in this chapter.

Starting LCI

To start the software, double-click the LCI icon on your Windows desktop.



Results:

- LCI polls the modules in the chassis
- The main LCI window displays

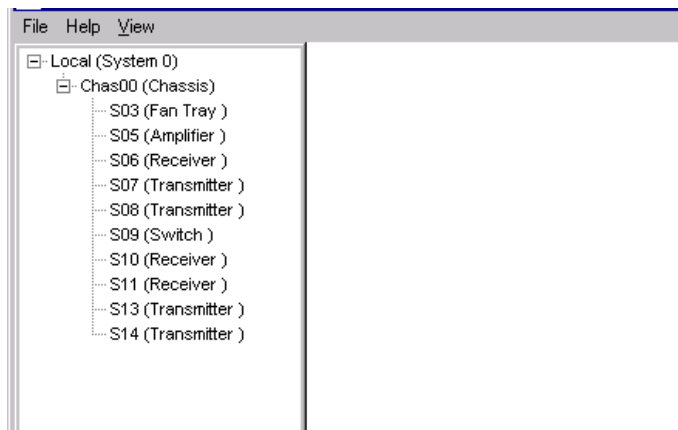

LCI Module Tree Overview

Introduction

The main window of LCI contains a tree that represents your system in a hierarchical manner.

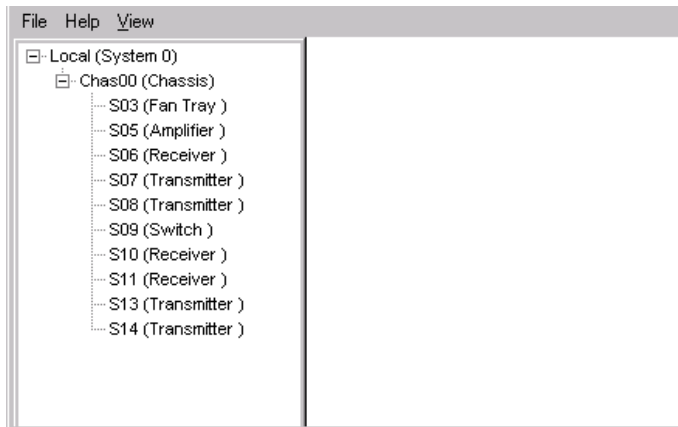

Module Tree

In the graphic above, the module tree represents a computer connected to a chassis that contains ten modules. The three tree levels are described in the following table.

Module Tree Level	Description
Local (System 0)	Computer being used
Chass00 (Chassis)	Chassis the computer is connected to
Sxx (Module name)	Module(s) located within the chassis. Each module is of the format <i>chassis slot location (module name)</i> . Example: In the graphic above, S09 (Switch) represents an optical switch that's located in slot nine of the chassis.

LCI Module Tree Overview, Continued

Module Information

Information about a module (its parameters, alarms and statuses) is located in the Module Details window. Within the module tree, you can access this window using one of the following four methods:

- Double-click the chassis and select the module in the graphic that displays
- Right-click the chassis and select **Open** from the menu that displays
- Double-click the module
- Right-click the module and select **Details** from the menu that displays

Note: Although you can use the method that's most convenient for you, the procedures throughout this chapter are described using the right-click module technique.

For more information about each of these methods, refer to the next section, **Accessing the Module Details Window**.

Accessing the Module Details Window

Introduction

Information about a module (its parameters, alarms and statuses) is located in the Module Details window. The graphic below shows the Module Details window for a Prisma II Low Input Optical Switch.

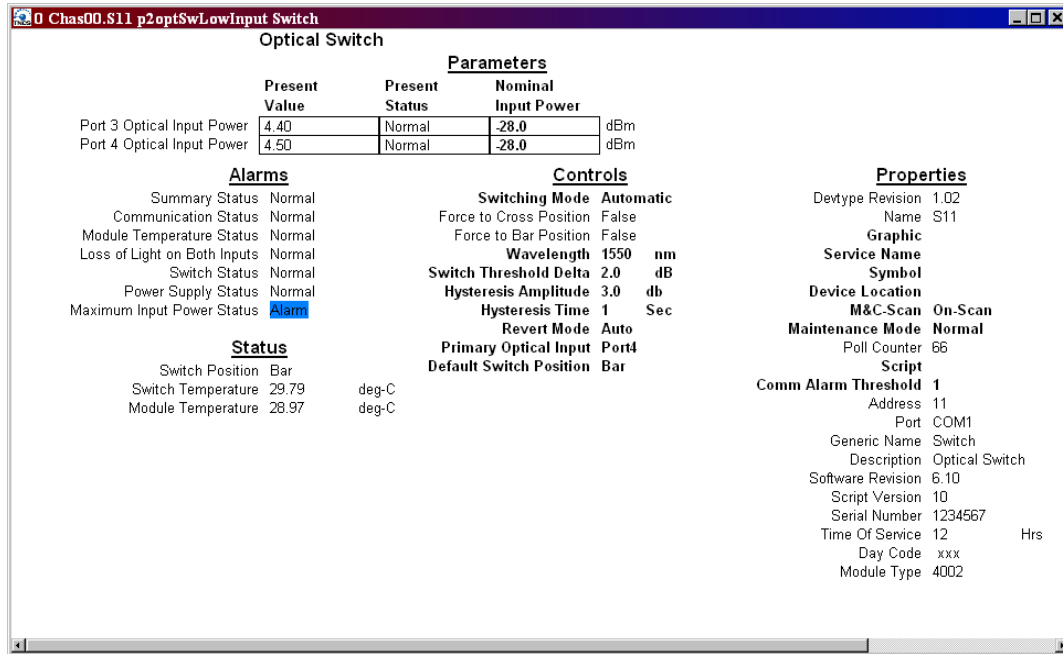

Within LCI's module tree, you can access this window using one of the following four methods:

- Double-click the chassis and select the module in the graphic that displays
- Right-click the chassis and select **Open** from the menu that displays
- Double-click the module
- Right-click the module and select **Details** from the menu that displays

Note: Although you can use the method that's most convenient for you, the procedures throughout this chapter are described using the right-click module technique.

For more information about the module tree, refer to **LCI Module Tree Overview** earlier in this chapter.

Accessing the Module Details Window, Continued

Double-Click the Chassis

To access the Module Details window, follow these steps.

1. Double-click the chassis.

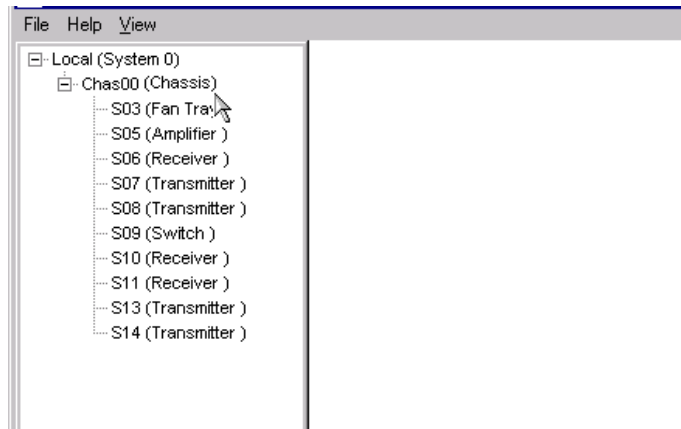

Result: A graphic representation of the chassis displays.

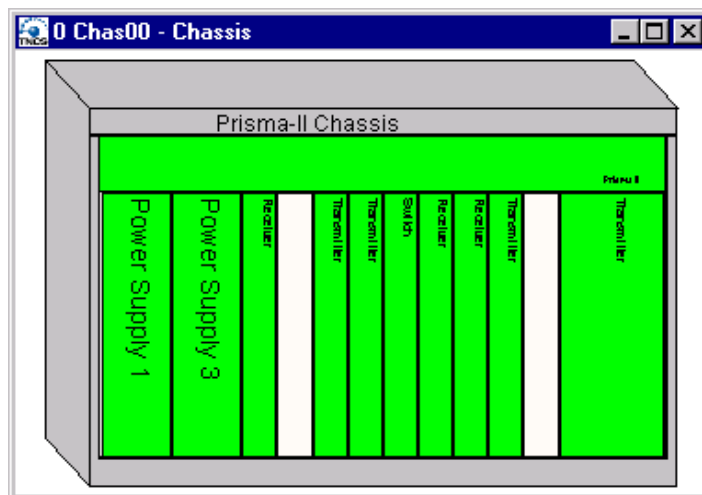

Accessing the Module Details Window, Continued

- Double-click the module whose information you want to view and/or configure.

Result: The Module Details window displays.

Optical Switch

<u>Parameters</u>			
	<u>Present Value</u>	<u>Present Status</u>	<u>Nominal Input Power</u>
Port 3 Optical Input Power	4.40	Normal	-28.0 dBm
Port 4 Optical Input Power	4.50	Normal	-28.0 dBm

Alarms

- Summary Status: Normal
- Communication Status: Normal
- Module Temperature Status: Normal
- Loss of Light on Both Inputs: Normal
- Switch Status: Normal
- Power Supply Status: Normal
- Maximum Input Power Status: **Alarm**

Controls

- Switching Mode: Automatic
- Force to Cross Position: False
- Force to Bar Position: False
- Wavelength: 1550 nm
- Switch Threshold Delta: 2.0 dB
- Hysteresis Amplitude: 3.0 dB
- Hysteresis Time: 1 Sec
- Revert Mode: Auto
- Primary Optical Input: Port4
- Default Switch Position: Bar

Status

- Switch Position: Bar
- Switch Temperature: 29.79 deg-C
- Module Temperature: 28.97 deg-C

Properties

- Devtype Revision: 1.02
- Name: S11
- Graphic
- Service Name
- Symbol
- Device Location
- M&C-Scan: On-Scan
- Maintenance Mode: Normal
- Poll Counter: 66
- Script
- Comm Alarm Threshold: 1
- Address: 11
- Port: COM1
- Generic Name: Switch
- Description: Optical Switch
- Software Revision: 6.10
- Script Version: 10
- Serial Number: 1234567
- Time Of Service: 12 Hrs
- Day Code: xxx
- Module Type: 4002

- Proceed with viewing and/or configuring information.

Accessing the Module Details Window, Continued

Right-Click the Chassis

To access the Module Details window, perform these steps.

1. Right-click the chassis, and click **Open**.

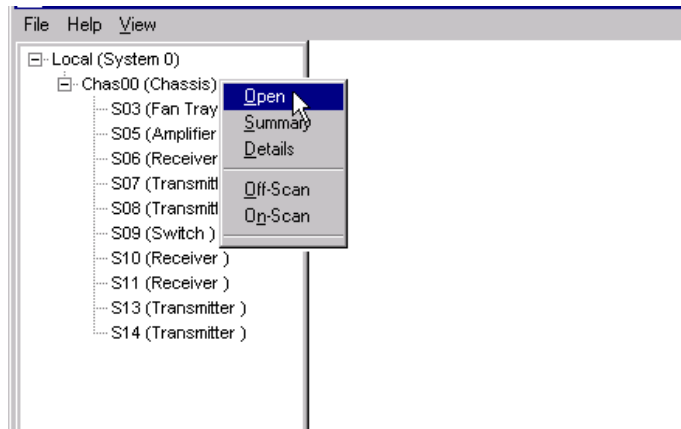

Result: A graphic representation of the chassis displays.

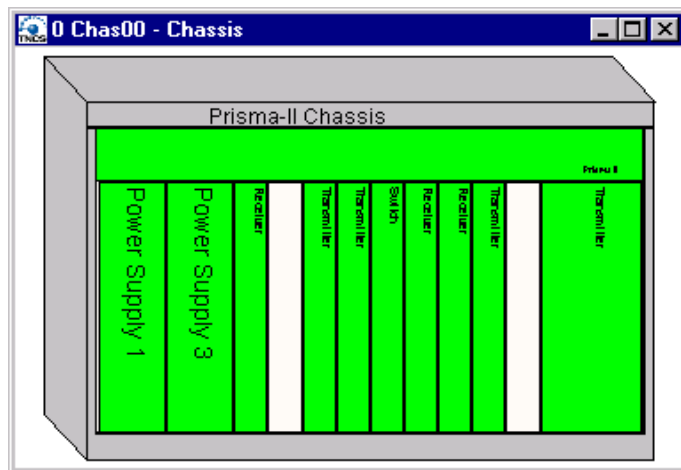

Accessing the Module Details Window, Continued

- Double-click the module whose information you want to view and/or configure.

Result: The Module Details window displays.

Optical Switch

<u>Parameters</u>			
	<u>Present Value</u>	<u>Present Status</u>	<u>Nominal Input Power</u>
Port 3 Optical Input Power	4.40	Normal	-28.0 dBm
Port 4 Optical Input Power	4.50	Normal	-28.0 dBm

Alarms

- Summary Status: Normal
- Communication Status: Normal
- Module Temperature Status: Normal
- Loss of Light on Both Inputs: Normal
- Switch Status: Normal
- Power Supply Status: Normal
- Maximum Input Power Status: **Alarm**

Controls

- Switching Mode: Automatic
- Force to Cross Position: False
- Force to Bar Position: False
- Wavelength: 1550 nm
- Switch Threshold Delta: 2.0 dB
- Hysteresis Amplitude: 3.0 dB
- Hysteresis Time: 1 Sec
- Revert Mode: Auto
- Primary Optical Input: Port4
- Default Switch Position: Bar

Status

- Switch Position: Bar
- Switch Temperature: 29.79 deg-C
- Module Temperature: 28.97 deg-C

Properties

- Devtype Revision: 1.02
- Name: S11
- Graphic
- Service Name
- Symbol
- Device Location
- M&C-Scan: On-Scan
- Maintenance Mode: Normal
- Poll Counter: 66
- Script
- Comm Alarm Threshold: 1
- Address: 11
- Port: COM1
- Generic Name: Switch
- Description: Optical Switch
- Software Revision: 6.10
- Script Version: 10
- Serial Number: 1234567
- Time Of Service: 12 Hrs
- Day Code: xxx
- Module Type: 4002

- Proceed with viewing and/or configuring information.

Accessing the Module Details Window, Continued

Double-Click the Module

To access the Module Details window, perform these steps.

1. Double-click the module.

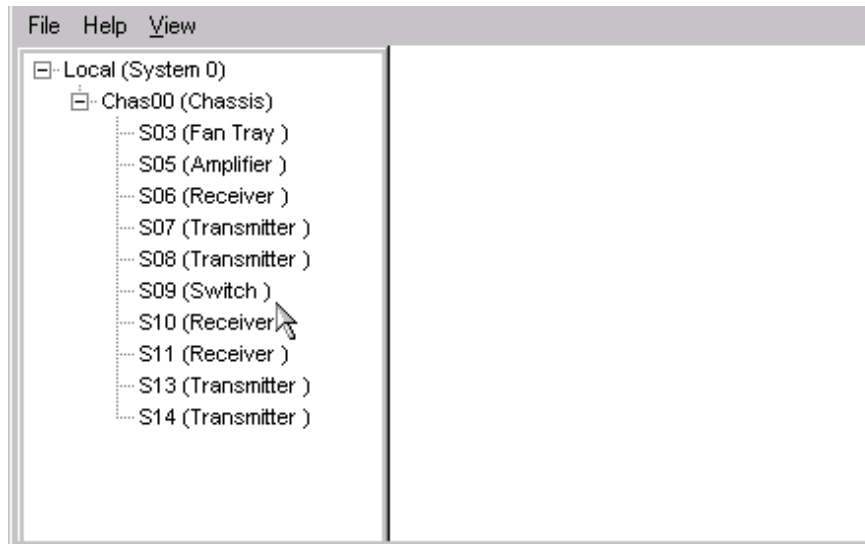

Result: The Module Details window displays.

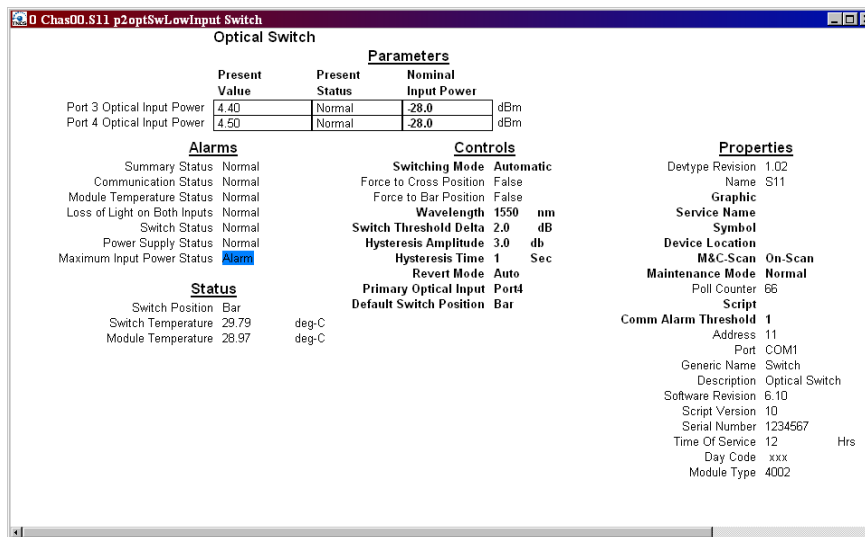

2. Proceed with viewing and/or configuring information.

Accessing the Module Details Window, Continued

Right-Click the Module

To access the Module Details window, perform these steps.

1. Right-click the module, and click **Details**.

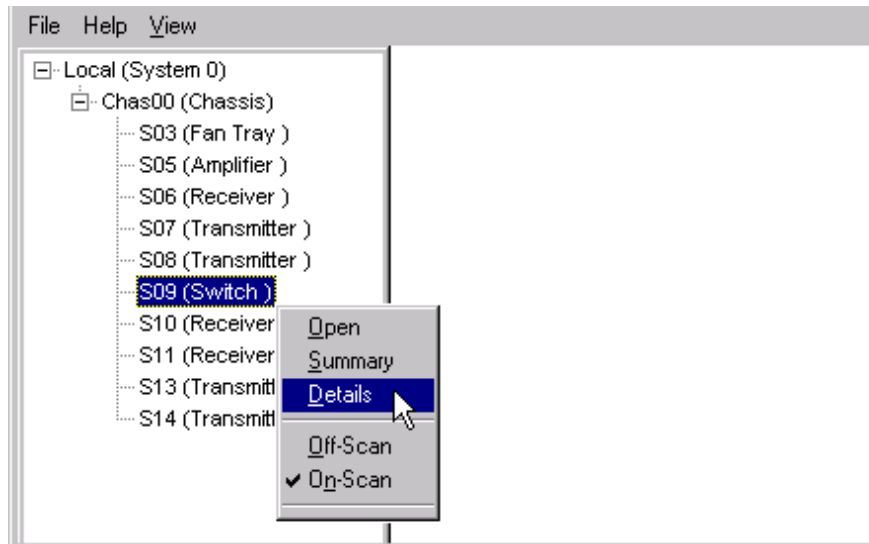

Result: The Module Details window displays.

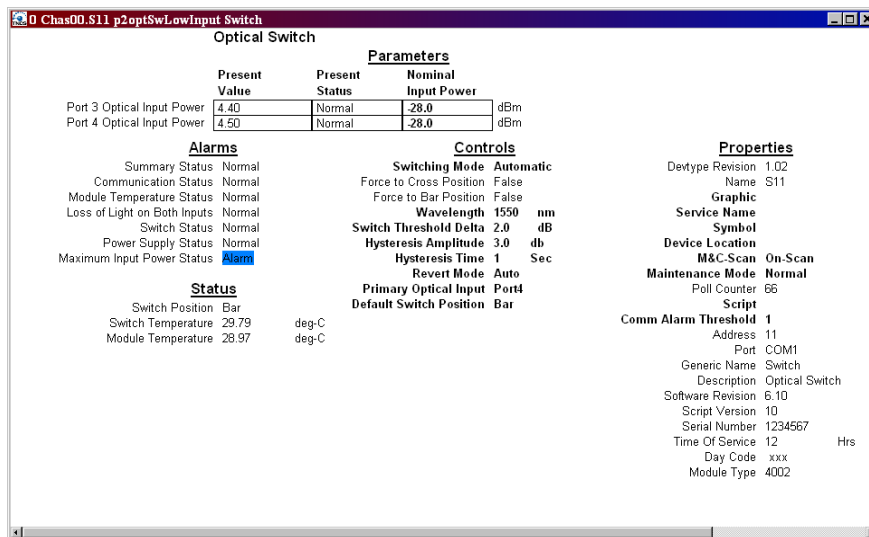

2. Proceed with viewing and/or configuring information.

Checking the Operating Status

Introduction

Using LCI, you can check the status of all operating parameters of the optical switch.

Monitored Parameters

The table below describes the monitored parameters for the optical switch.

Parameter	Units	Function	Standard Typical Value	Low Input Typical Value
Port 3 Optical Power	dBm	Input optical power on Port 3	1310 nm -13 dBm to 13 dBm 1550 nm -13 dBm to 18 dBm	1310 nm -28.0 dBm to 0 dBm 1550 nm -28.0 dBm to 0 dBm
Port 4 Optical Power	dBm	Input optical power on Port 4	1310 nm -13 dBm to 13 dBm 1550 nm -13 dBm to 18 dBm	1310 nm -28.0 dBm to 0 dBm 1550 nm -28.0 dBm to 0 dBm
Switch Position	Integer	Read switch position	Bar Cross	Bar Cross
Module Temperature	°C	Module temperature	-40°C to +65°C	-40°C to +65°C

Checking the Operating Status, Continued

Checking the Operating Status

To monitor the optical switch operating parameters, follow these steps.

1. In the module tree, right-click the Prisma II Optical Switch, and click **Details**.

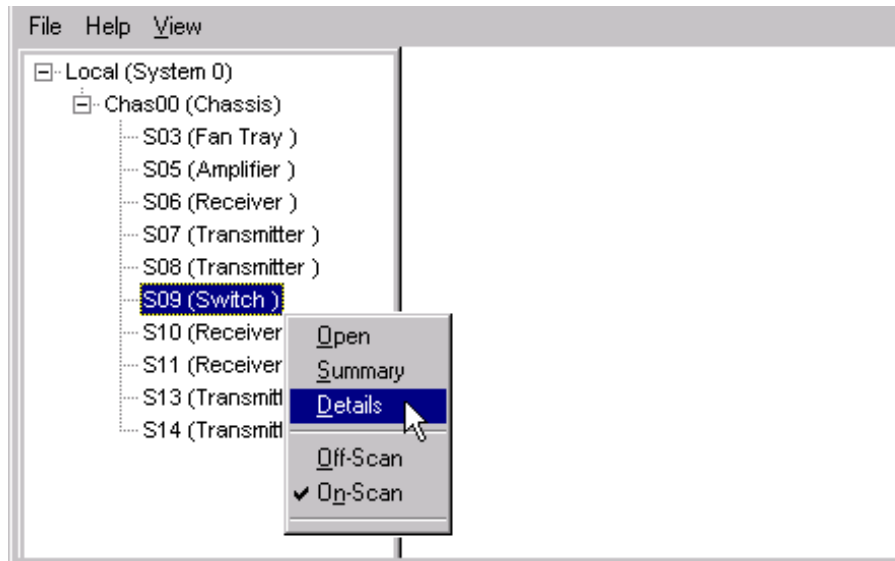

Result: The Module Details window displays. The monitored parameters are displayed under **Parameters** and **Status**.

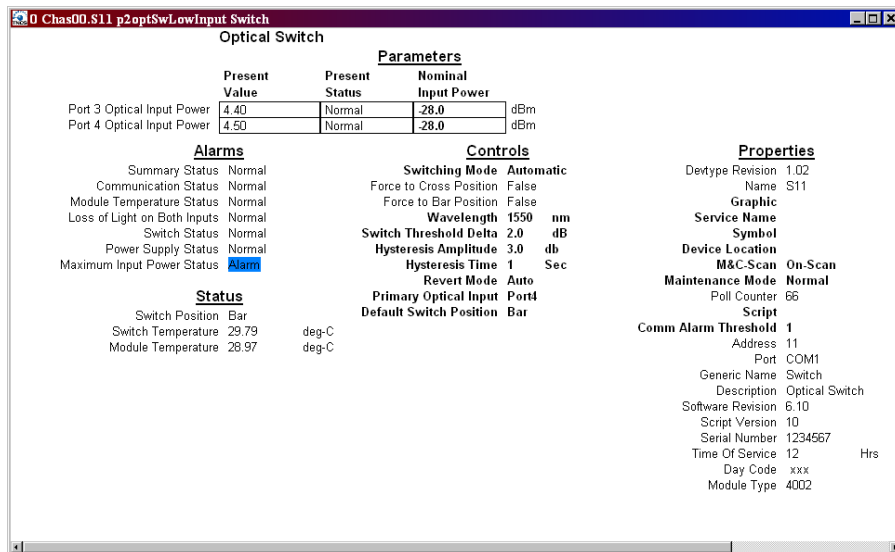

2. Proceed with checking the operating parameters.

Configuring the Optical Switch

Introduction

Using LCI, you can configure the parameters listed below.

Configurable Parameters

Configurable parameters for the Prisma II Optical Switch are listed below.

Parameter	Function	Standard		Low Input	
		Values	Default	Values	Default
Port 3 Optical Power	Nominal input optical power at input 3, in dBm	1310 nm -13.0 dBm to 13.0 dBm, increments of 0.1 dBm	-3.0 dBm	1310 nm - 30.0 dBm to 0 dBm, increments of 0.1 dBm	-28.0 dBm
Port 4 Optical Power	Nominal input optical power at input 4, in dBm	1550 nm -13.0 dBm to 18.0 dBm, increments of 0.1 dBm		1550 nm -30.0 dBm to 0 dBm, increments of 0.1 dBm	
Mode Status	Selects automatic or manual mode.	Manual Automatic	Automatic	Manual Automatic	Automatic
Set Cross Position	If True, the switch to change to the Cross position. Reset to False after < 50 ms	False True	False	False True	False
Set Bar Position	If True, the switch to change to the Bar position. Reset to False after < 50 ms	False True	False	False True	False
Wave Length	Selects the wavelength of optical input.	1310 nm 1550 nm	1550 nm	1310 nm 1550 nm	1550 nm
Switch Threshold Delta	Delta: the value (in dB relative to nominal) below which the input optical power must fall for the switch to operate.	1.0 to 10.0 dB, increments of 0.1 dB	6.0 dB	1.0 to 10.0 dB, increments of 0.1 dB	2.0 dB

Configuring the Optical Switch, Continued

Parameter	Function	Standard		Low Input	
		Values	Default	Values	Default
Hysteresis Amplitude	Hysteresis Amplitude: the value (in dB relative to switching threshold) above which the input optical power must rise for the switch to begin the hysteresis timer before restoring original switch position. Only applies if Revert is Auto.	0.5 to 9.5 dB, increments of 0.1 dB	3.0 dB	0.5 to 9.5 dB, increments of 0.1 dB	3.0 dB
HystTime	Hysteresis Time. Auto mode only. Length of time that primary optical power must remain above the restore threshold before switch will revert to primary position. Only applies if Revert is Auto.	Integer in seconds, between 0 and 600 (0 to 10 minutes)	1 sec	Integer in seconds, between 0 and 600 (0 to 10 minutes)	1 sec
Revert	In Auto, allows switch to revert to primary position after optical power is restored. In Manual, switch will remain in backup position	Manual Auto	Auto	Manual Auto	Auto
Primary Optical Input	Selects the primary optical input.	Port 3 Port 4	Port 4	Port 3 Port 4	Port 4
Set Switch Position	Selects the Normal switch position.	Cross Bar	Bar	Cross Bar	Bar

Configuring the Optical Switch, Continued

Configuring Parameters

To configure the parameters, follow these steps.

1. In the module tree, right-click the Prisma II Optical Switch, and click **Details**.

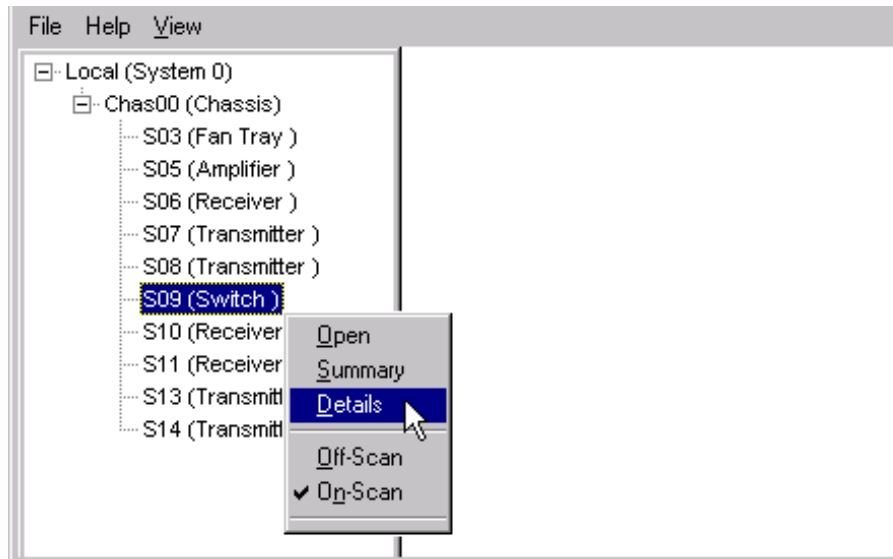

Result: The Module Details window displays.

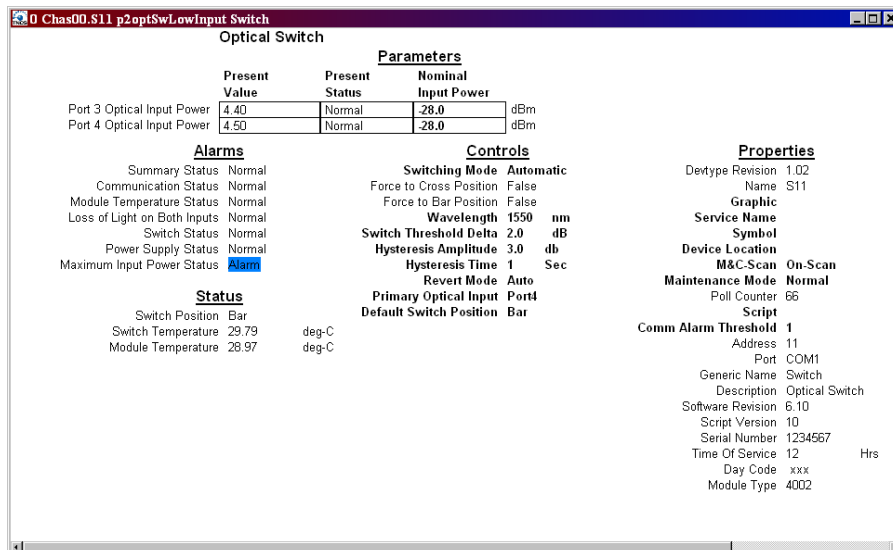

Configuring the Optical Switch, Continued

2. Under **Controls**, double-click the parameter you want to configure.

Result: The Change Value dialog box displays. The graphic below shows the dialog box for the Set Switch Position parameter.

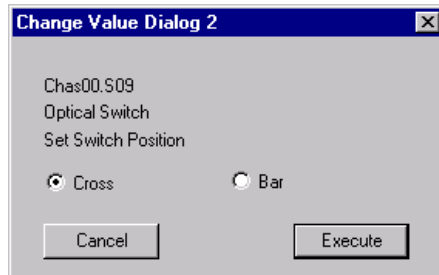

3. Depending on the parameter you chose, select or type a new value.
4. Click **Execute**.

Result: The new value displays next to the parameter.

Checking Optical Switch Alarms

Introduction

Using LCI, you can check the alarm status of various parameters. Alarms that you can check are listed below.

Alarm	Function	Possible Cause
Loss of Light Status	Detects loss of light	Input dark
Module Temperature	Module Temp above high threshold or below low threshold	Temp Alarm

Checking Optical Switch Alarms, Continued

Checking Alarms

To check a parameter's alarm status, perform these steps.

1. Right-click the Prisma II Optical Switch, and click **Details**.

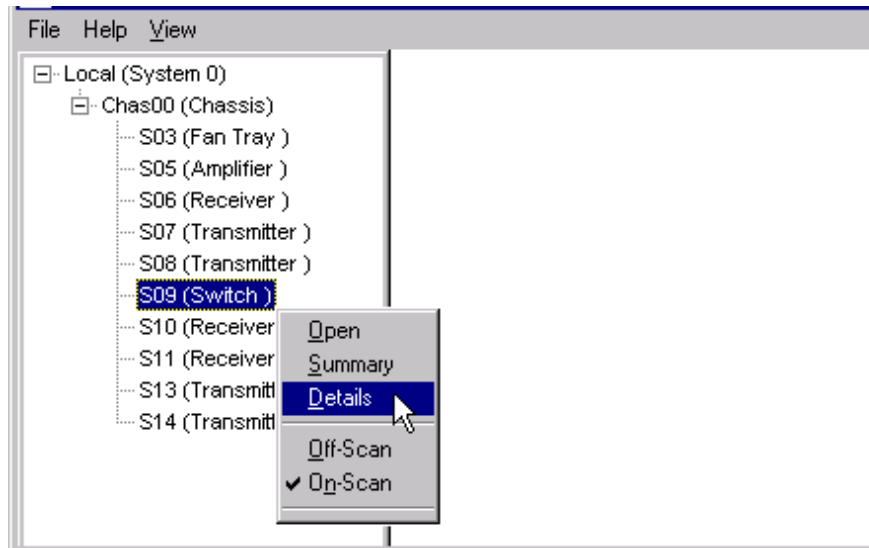

Result: The Module Details window displays. The alarms are shown under **Parameters and Alarms**.

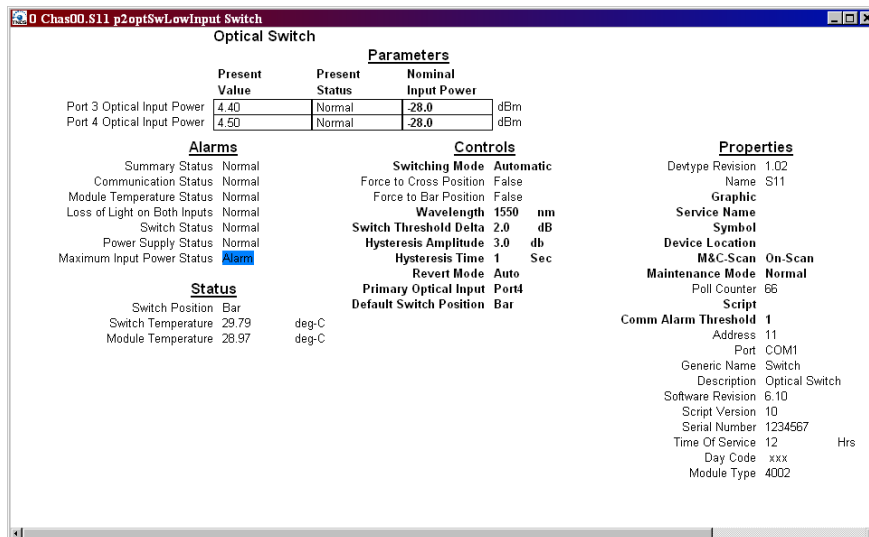

2. If any of the parameters are in alarm, take the corrective action you deem necessary.

Modifying Optical Switch Alarm Limits

Introduction

Using LCI, you can modify the nominal input power for both ports. These parameters are listed below.

Alarm	Function	Standard Nominal Input Power Range	Low Input Nominal Input Power Range
Port 3 Optical Power	Nominal input optical power at input 3, in dBm	1310 nm -13.0 dBm to 13.0 dBm, increments of 0.1 dBm	1310 nm -30.0 dBm to 0 dBm, increments of 0.1 dBm
Port 4 Optical Power	Nominal input optical power at input 4, in dBm	1550 nm -13.0 dBm to 18.0 dBm, increments of 0.1 dBm	1550 nm -30.0 dBm to 0 dBm, increments of 0.1 dBm

Modifying Alarm Limits

To modify a parameter's alarm limit, follow these steps.

1. In the module tree, right-click the Prisma II Optical Switch, and click **Details**.

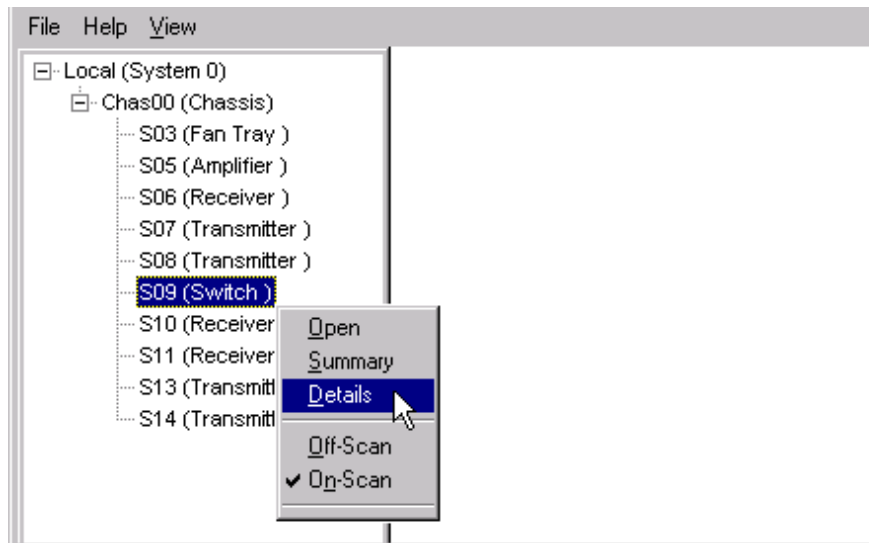

Modifying Optical Switch Alarm Limits, Continued

Result: The Module Details window displays. The alarm limits are shown under **Parameters**.

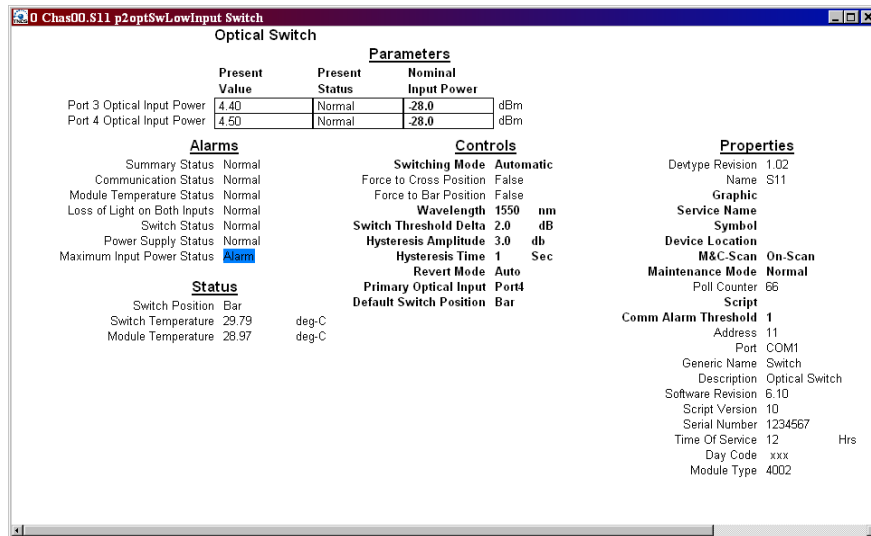

2. Double-click the limit you want to change.

Result: The Change Value dialog box displays. The graphic below shows the dialog box for the nominal input power of the Port 4 Optical Power parameter.

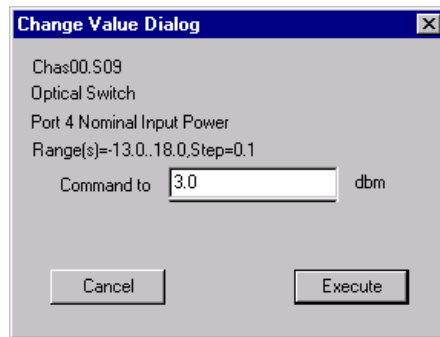

3. In the **Command to** box, type the value to use for the limit.
4. Click **Execute**.

Result: The new value displays in the alarm limit column.

Checking Manufacturing Data

Introduction

Using LCI, you can check the manufacturing data of the optical switch.

Manufacturing Data

The table below describes the manufacturing data available for this module.

Manufacturing Data	Standard Typical Values	Low Input Typical Values
Description	Optical Switch	Optical Switch
Module Type	4000	4002
Serial number	!ABCDEF	!ABCDEF
Software Revision	6.10	6.10
Script Version	7	7
Time of Service	1	1

Checking Manufacturing Data, Continued

Checking Manufacturing Data

To access the module's manufacturing data, perform these steps.

1. In the module tree, right-click the Prisma II Optical Switch, and click **Details**.

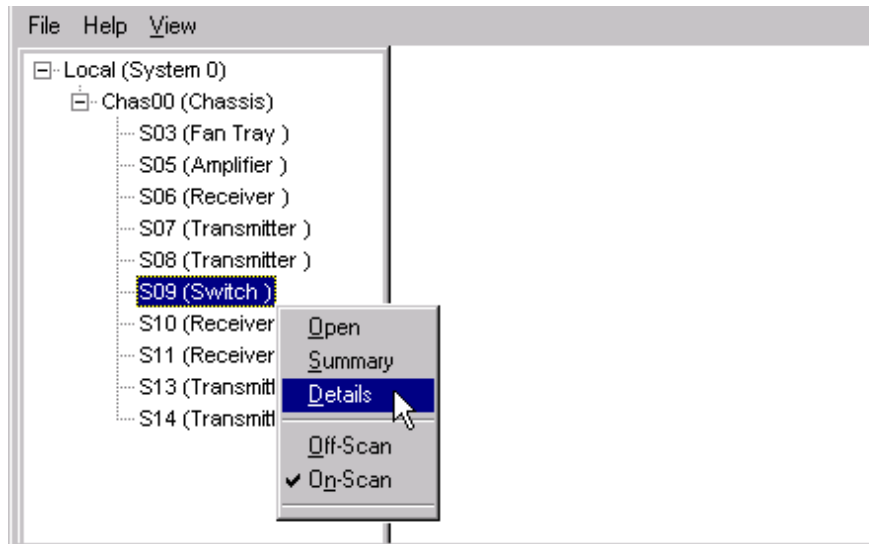

Result: The Module Details window displays. The manufacturing data is displayed under **Properties**.

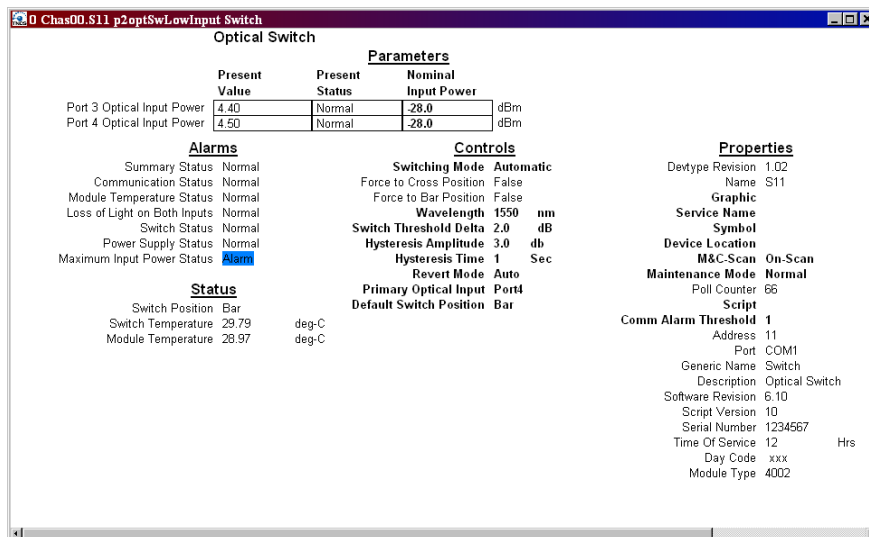

2. Proceed with viewing the manufacturing data.

Chapter 5

Maintenance and Troubleshooting

Overview

Introduction

This chapter provides information to assist you in maintaining and troubleshooting Prisma II Optical Switch.

Qualified Personnel

Only appropriately qualified and trained personnel should attempt to troubleshoot this product.



WARNING:

Allow only qualified personnel to install, operate, maintain, or service this product. Otherwise, personal injury or equipment damage may occur.

In This Chapter

This chapter contains the following topics.

Topic	See Page
Module Maintenance	5-2
General Troubleshooting Information	5-3
Troubleshooting Alarm Conditions	5-4

Module Maintenance

Maintaining the Prisma Module

To ensure optimal performance, the following maintenance is recommended.

Frequency	Maintenance Required
Weekly	<ul style="list-style-type: none">• Check all parameters and test points• Record data• Make adjustments as needed
Quarterly	<ul style="list-style-type: none">• Make sure all cables are mated properly• Inspect cables for stress and chafing• Make sure all retaining screws are tight
When needed	Carefully clean the module with a soft cloth that is dampened with mild detergent

Maintenance Record

It may be helpful to establish a maintenance record or log for this module. You may want to record optical input level, or power supply voltages.

Large variations in any of the parameters above should be investigated prior to failure.

General Troubleshooting Information

Introduction

This troubleshooting information describes the most common alarms and gives typical symptoms, causes, and items to check before consulting Cisco Services.

Equipment Needed

You may need the following equipment to troubleshoot the chassis.

- Digital voltmeter
- Fiber connector cleaning materials

Additional Assistance

If you need additional assistance, contact Cisco Services or your local sales subsidiary.

Troubleshooting



WARNING:

Avoid electric shock and damage to this product! Do not open the enclosure of this product. There are no user-serviceable parts inside. Refer servicing to qualified service personnel.

Refer to the following section, **Troubleshooting Alarm Conditions**, to identify and correct faults.

Troubleshooting Alarm Conditions

Alarm Conditions

If the red ALARM indicator is illuminated or is blinking, check the display on the front panel to determine the cause of the alarm.

Alarm	Function	Possible Causes	Possible Solutions
PInLoss3	Detects loss of light at input 3	Input 3 dark	<ul style="list-style-type: none"> • Check both optical sources. • Check optical connections.
PInLoss4	Detects loss of light at input 4	Input 4 dark	<ul style="list-style-type: none"> • Check both optical sources. • Check optical connections.
TempAlm	Module Temp above or below threshold	Ambient temperature is too high due to: <ul style="list-style-type: none"> • Air conditioner malfunction. 	Diagnose the problem and repair or replace as needed.
		<ul style="list-style-type: none"> • Airflow through the rack restricted or cut off. 	Ensure the airflow system has not been damaged or removed. Repair or replace as needed.
		<ul style="list-style-type: none"> • Fan Tray cooling fans are not operating properly. 	Troubleshoot the fans. Contact Cisco Services for assistance.
BothDark	Detects loss of light at both inputs	Inputs 3 and 4 dark	<ul style="list-style-type: none"> • Check both optical sources. • Check optical connections.
NoSwitch	Detects failure of switch	<ul style="list-style-type: none"> • Switch not seated properly • Switch failure 	<ul style="list-style-type: none"> • Check module seating. • Contact Cisco Services for assistance.
PsOk	Status of voltage rails	Power supply OK	No action required.

Chapter 6

Customer Information

If You Have Questions

If you have technical questions, call Cisco Services for assistance. Follow the menu options to speak with a service engineer.

Access your company's extranet site to view or order additional technical publications. For accessing instructions, contact the representative who handles your account. Check your extranet site often as the information is updated frequently.

Glossary

Term, Acronym, Abbreviation	Meaning
CAN	Cancel
DFB	Distributed feedback laser
EIA	Electronics Industry Association
ICIM	Intelligent Communications Interface Module
LCD	Liquid crystal display
LCI	Local craft interface
LED	Light emitting diode
NMS	Network Management System
nm	Nanometers
MIB	Management Information Base
PLL	Phase Lock Loop. An electronic servo system controlling an oscillator to maintain a constant phase angle relative to a reference signal.
RF	Radio frequency
RMA	Return material authorization
SBS	Stimulated Brillouin scattering
SNMP	Simple Network Management Protocol
TNCS	Transmission Network Control System
Torque	Force applied to bolt or screw to tighten the device

Index

Accessing the Module Details Window, 4-11

Accessing the Password Menu, 3-7

Accessories, xii

Alarm Conditions, 5-4

Back panel, 1-5

Basic SNMP Setup, 3-29

block diagram, 1-3

Cable Connection Procedure, 2-11

Changing the User Password, 3-10

chassis

communications connections, 2-12

chassis-to-chassis communications, 2-12

Chassis-to-Chassis ICIM Connections, 2-12

Checking Alarms, 3-23, 4-25

Checking Manufacturing Data, 3-26, 4-29

Checking Operating Status, 3-17

Checking the Operating Status, 4-19

Circuit Overload, ix

Class I Mains Powered Equipment, viii

Class II Mains Powered Equipment, viii

Cleaning Optical Connectors, 2-9

Community Names, 3-33

Computer Requirements, 4-3

CONFIG Menus, 3-22

Configurable Parameters, 3-21, 4-20

configuration and monitoring methods, 1-6

Configuring Parameters, 3-20

Configuring Parameters, 4-22

Connecting a Chassis to the TNCS Server, 2-13

Connecting a Computer to the Chassis, 4-7

Connecting the PC to the Chassis, 4-3

Connection to -48 V DC/-60 V DC Power Sources, ix

connections

multiple chassis, 2-14

connector, 1-5

Description, 1-2

Disabling the User Password, 3-12

Electric Shock Hazard, v

electromagnetic compatibility (EMC)
regulatory requirements, xi

Electrostatic Discharge, x

Entering the User Password, 3-8

equipment needed, 2-2

Equipment Placement, vi

equipment rack, 2-3

Equipotential Bonding, ix

FCC Statement, xi

features, 1-2

fiber chip warning, xiii

Fiber Fish Tool, 2-8

Front Access Chassis, 2-5

front panel, 1-4

Fuse Replacement, x

General Servicing Precautions, ix

Grounding, viii

Grounding Terminal, viii

Grounding-Type Plug, viii

Handling Precautions, vii

Heed Warnings, v

ICIM Block Diagram, 3-2

ICIM Front Panel, 3-3

ICIM Function, 3-2

ICIM Key Pad, 3-5

ICIM LCD, 3-4

ICIM LCD Contrast, 3-13

ICIM MAIN Menu and Menu Structure, 3-15

ICIM Password, 3-6

Important Safety Instructions, v

Installing the LCI Software, 4-4

Installing the Module, 2-6

Keypad

ICIM, 3-5

Laser

modifications, xii

safety, xiii

Laser Beam Apertures, xvi

laser label, xv

laser safety, xiii

LCI Function, 4-2

LCI Module Tree, 4-9

Lithium Battery, x

MAIN Menu, 3-13

maintainance, 5-1

Manufacturing Data, 4-28

Manufacturing Data Display, 3-27

MFG. DATA Menus, 3-27

Modifying Alarm Limits, 4-26

Module Alarm Data, 3-25

Module Alarm Menus, 3-25

Monitored Parameters, 3-18, 4-18

Operating environment, 2-3

operation, 1-3

Operation

Front Panel

ICIM, 3-3

optical output, 1-3

Optical Switch Alarms, 4-24

Optical Switch Software Menu Structure, 3-16

Packing and Shipping the Product, 6-5

password

ICIM, 3-6

Polarized Plug, viii

power, ix

Power Requirements, 2-4

preparing for installation, 2-2

Previous IP Address, 3-36

Prisma DT

power, ix

Product Specific Laser Information, xv

product support, 6-1

Pull Optical Cable to Module, 2-9

Rack Mounting Safety Precautions, vii

Elevated Operating Ambient
Temperature, vii

Mechanical Loading, vii

Reduced Airflow, vii

radiation warning, xiii

Radiation Warning Labels, xvi

Read Community, 3-33

Read/Write Community, 3-33

Rear Access Chassis, 2-5

Index, Continued

Restarting the ICIM, 3-32

Safety Plugs, viii

Safety Plugs (European Union), viii

Saving the Current Configuration, 3-28

Set Traps in P2TrapRecvEntry, 3-34

Setting SNMP Trap Receiver Parameters, 3-34

Setting Up the IP Configuration Parameters for SNMP Support, 3-29

site requirements, 2-3

SNMP Configuration Capability, 3-29

SNMP Variables, 3-35

Space Requirements, 2-4

Starting LCI, 4-8

STATUS Menus, 3-19

Table of Inserted Modules, 3-35

Table of Removed Modules, 3-35

tools needed, 2-2

Trap Community, 3-33

troubleshooting, 5-1

Troubleshooting Alarm Conditions, 5-4

User Alarm Data Display, 3-24

User Alarm Menus, 3-24

Using the ICIM, 3-13

Ventilation, vi



Cisco Systems, Inc.
5030 Sugarloaf Parkway, Box 465447
Lawrenceville, GA 30042

678 277-1120
800 722-2009
www.cisco.com

This document includes various trademarks of Cisco Systems, Inc. Please see the Notices section of this document for a list of the Cisco Systems, Inc. trademarks used in this document.

Product and service availability are subject to change without notice.

© 2003, 2008, 2013 Cisco and/or its affiliates.

All rights reserved.

January 2013 Printed in USA

Part Number 78-715188-01 Rev E