



RoomOS 10.19

Cisco Webex Desk, Desk Mini, and Desk Pro User guide

What's in this guide

Introduction

Cisco Webex Desk Pro	4
Cisco Webex Desk.....	5
Cisco Webex Desk Mini	6
RoomOS 11: Basic navigation.....	7
RoomOS 11: Control panel and device settings	8
RoomOS 11: Video calls	9
RoomOS 11: Content sharing	10
Pair with a Bluetooth® headset and other devices	11
Audio settings	12
Use as a USB camera.....	13
Sign in with your own credentials.....	14

Video calls

Place a call from contact list	16
Edit a contact before calling.....	17
Place a call using name, number, or address.....	18
Incoming calls	19
Receive a call while in another call.....	20
Disconnect yourself from a call	21
Put call on hold and resume a call on hold.....	22
Transfer an ongoing call.....	23
Change the call rate.....	24
Activate do not disturb.....	25
Automated forwarding of all calls	26
View keypad while in a call.....	27
Add additional participants to an existing call.....	28
Disconnect a participant from a conference	29
Admit a participant to a meeting	30
Pin a speaker in a meeting.....	31
Use Music mode	32
Raise hand in a meeting.....	33
Use gestures in a meeting	34
Find call details for recent calls	35

Intelligent Proximity

Cisco Proximity ultrasound signal.....	37
--	----

Content sharing

Share content in a call	39
Change presentation layout in a call	40
Use as a digital whiteboard.....	41
End your session to clear your device.....	42
Wired touch redirect	43
Web apps	44

Scheduled meetings

Join a scheduled meeting	46
Join a Webex meeting	47

Contacts

Favorites, Recents, and Directory.....	49
Add someone to Favorites, while in a call	50
Add someone to Favorites, outside a call.....	51
Edit an existing Favorite	52

Camera control

Turn selfview on and off.....	54
Move the selfview PiP	55
Far-end camera control	56
Virtual backgrounds	57
Immersive share.....	58
Manual camera control.....	59

Settings

Available settings	61
--------------------------	----

All entries in the table of contents are active hyperlinks that take you to the corresponding article.

To go between chapters, you can click on the icons in the sidebar.

This guide describes the use of Cisco Webex Desk, Desk Mini, and Desk Pro when registered to an on-premises service.

Note: Some of the features described in this user guide may be optional in certain markets and they may not apply to your device.



Introduction

Cisco Webex Desk Pro

Use as PC monitor. Use an HDMI or USB-C cable to connect your computer (see below). If you use a USB-C cable, your laptop can be charged through the same cable.

To view the PC screen on Desk Pro, tap **Share Screen** and **Preview**.

Incoming calls appear as usual, irrespective of mode (PC or video) unless Do not disturb is active, see [“Activate do not disturb” on page 25.](#)

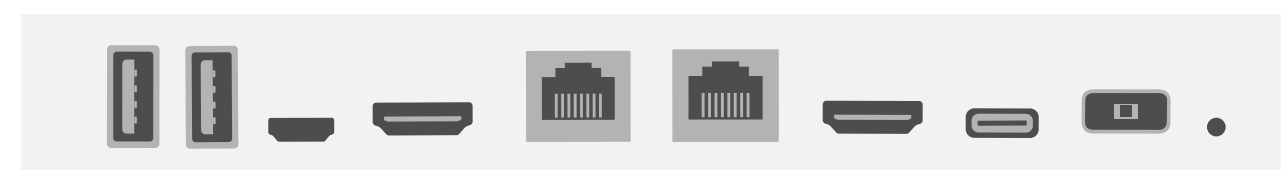
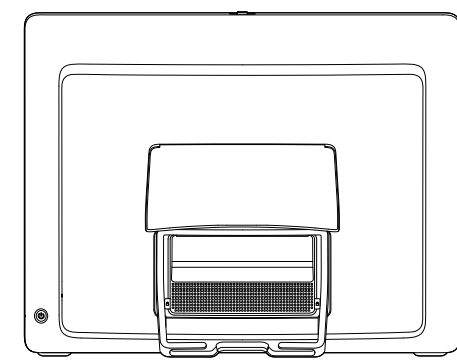

- 1 USB ports
- 2 Service port
- 3 HDMI out: screen
- 4 Network expansion connection. Connect your computer network here to let your Desk Pro and computer share a common connection
- 5 Network
- 6 HDMI in: content sharing
- 7 USB-C connector
- 8 Power
- 9 Factory reset pinhole



- 1 Camera with privacy shutter
- 2 Loudspeaker volume controls and microphone mute button
- 3 USB and mini-jack socket on the right side of the unit
- 4 Stylus
- 5 Loudspeaker
- 6 Microphones (6 locations)
- 7 Power On/Off on the back of the device

USB headsets

The Desk Pro implements the standard protocol for USB wired audio devices.

Note that Desk Pro also supports the use of Bluetooth headsets – see the following page for more.

Manufacturers can implement the standard differently (called HID protocol).

Consequently, different models from the same manufacturer can behave differently and we can't guarantee that all headsets and handsets work.

We have only tested wired headsets or headsets with a dongle.

Read more about USB headsets and see the full list of supported headsets in <https://help.webex.com/nkiifbo/>.

Cisco Webex Desk

Use as PC monitor. Use an HDMI or USB-C cable to connect your computer (see below).

To view the PC screen on Webex Desk, tap **Share Screen** and **Preview**.

Incoming calls appear as usual, irrespective of mode (PC or video) unless Do not disturb is active, see [“Activate do not disturb” on page 25.](#)

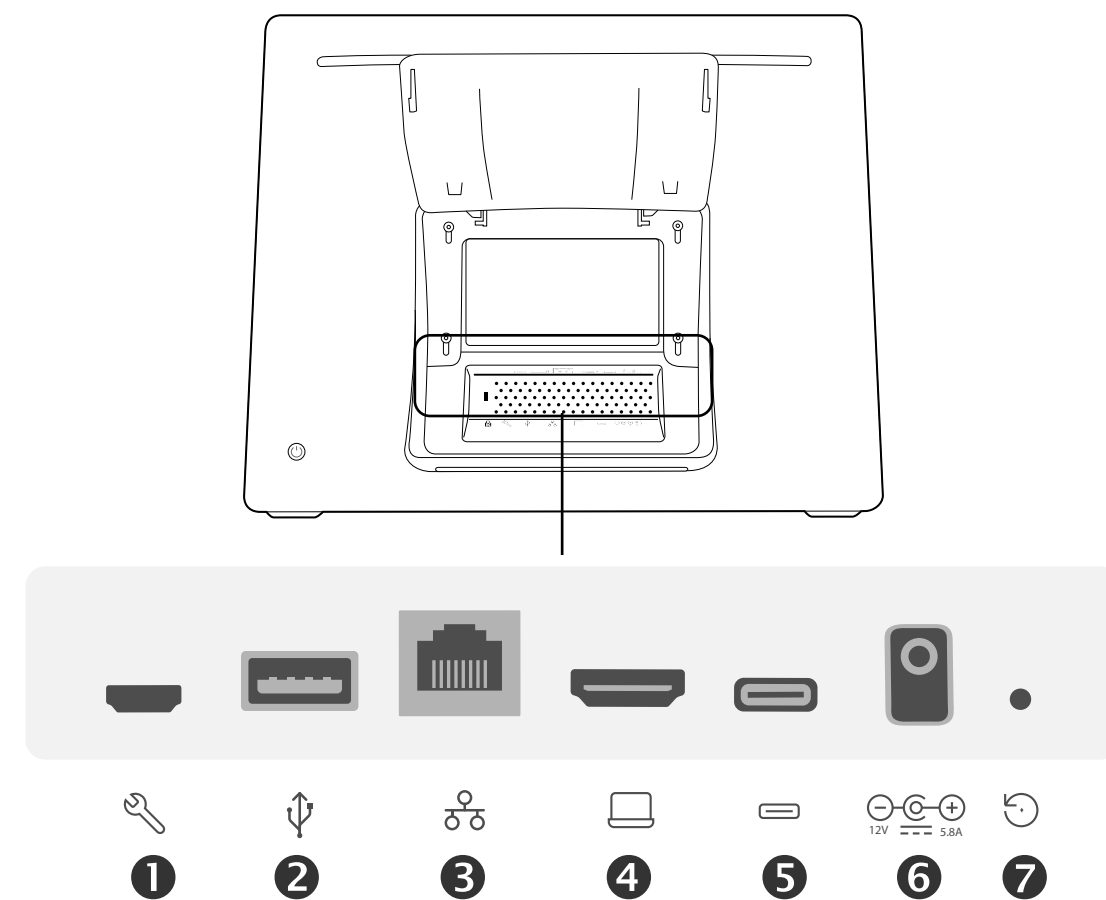

- ❶ Service port
- ❷ USB port: for headset
- ❸ Network
- ❹ HDMI in: content sharing
- ❺ USB-C connector
- ❻ Power
- ❼ Factory reset pinhole



- ❶ Camera with privacy shutter
- ❷ Loudspeaker volume controls and microphone mute button
- ❸ Loudspeaker
- ❹ Microphones (4 locations)
- ❺ Power On/Off on the back of the device

USB headsets

The Webex Desk implements the standard protocol for USB wired audio devices.

Note that Webex Desk also supports the use of Bluetooth headsets—see the following page for more.

Manufacturers can implement the standard differently (called HID protocol).

Consequently, different models from the same manufacturer can behave differently and we can't guarantee that all headsets and handsets work.

We have only tested wired headsets or headsets with a dongle.

Read more about USB headsets and see the full list of supported headsets in <https://help.webex.com/nkiifbo/>.

Cisco Webex Desk Mini

Use as PC monitor. Connect your computer with a USB-C cable. Extend your screen and use Desk Mini's speakers, microphone, camera, and touch control with the apps running on your laptop.

Incoming calls appear as usual, irrespective of mode (PC or video) unless Do not disturb is active, see ["Activate do not disturb" on page 25.](#)

There's a magnetic panel covering the connectors on the back of the device - you can pull it off and put it back on. Here are the connectors on your Desk Mini:

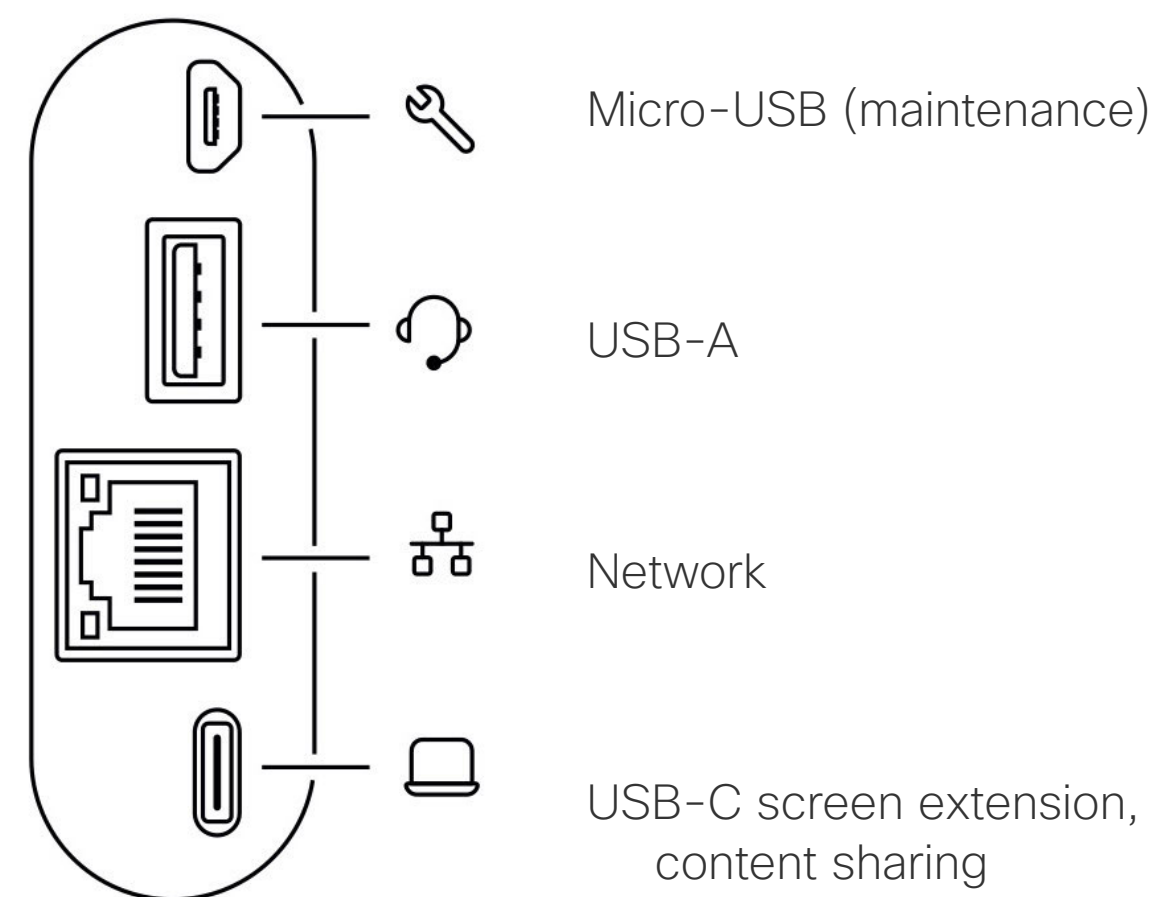

- ❶ Camera with privacy shutter
- ❷ Loudspeaker volume controls and microphone mute button
- ❸ Power On/Off on the back of the screen
- ❹ Loudspeaker
- ❺ Microphone

USB headsets

The Desk Mini implements the standard protocol for USB wired audio devices.

Note that Desk Mini also supports the use of Bluetooth headsets—see ["Pair with a Bluetooth headset and other devices" on page 6.](#)

Manufacturers can implement the standard differently (called HID protocol).

Consequently, different models from the same manufacturer can behave differently and we can't guarantee that all headsets and handsets work.

We have only tested wired headsets or headsets with a dongle.

Read more about USB headsets and see the full list of supported headsets in <https://help.webex.com/nkiifbo/>.

RoomOS 11: Basic navigation

Introducing RoomOS 11

Cisco Webex Desk Mini supports the new RoomOS 11 operating system by default. Now, administrators can toggle on the RoomOS 11 User Experience for Cisco Webex Desk Pro and Cisco Webex Desk, too.

While most familiar features work on RoomOS 11 in the same way as before, some have changed, or you access them in different places. There is also new functionality available.

This chapter introduces some of the new features and changes to existing ones that you'll find on the RoomOS 11 user interface on Desk Mini, Desk Pro, and Webex Desk.

Find out more about Desk Mini, and the RoomOS 11 User Experience, at <https://help.webex.com/n01kjh1/>.

Tap the device name to see its contact information.

To access the home screen and any open apps, swipe up with the bottom handle. This opens the task switcher.

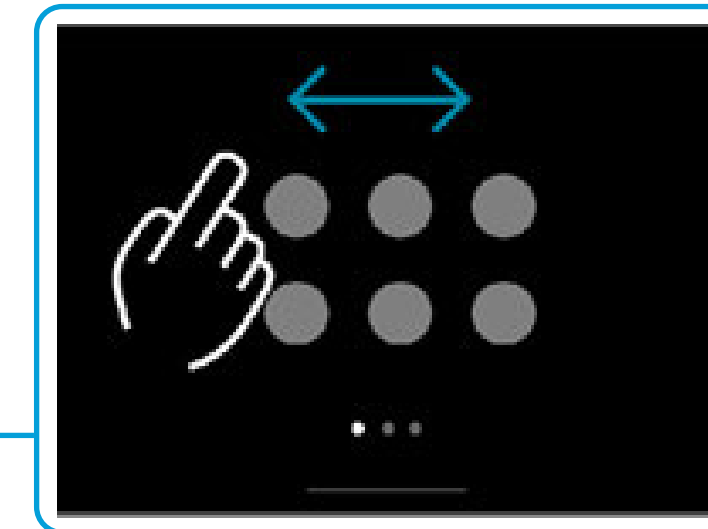
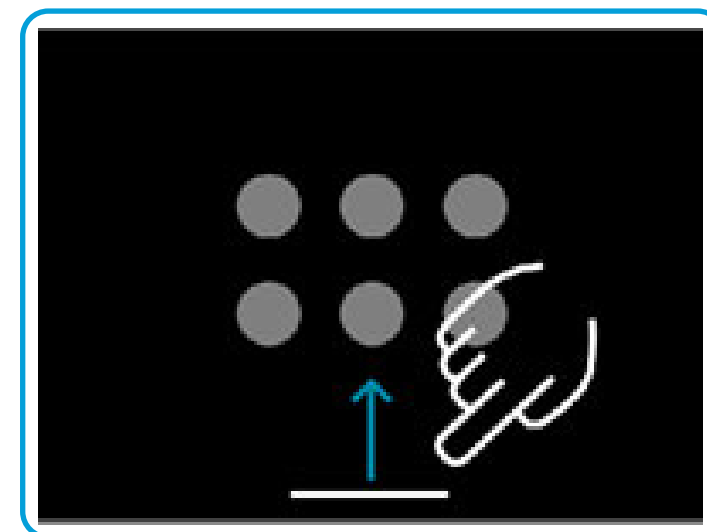
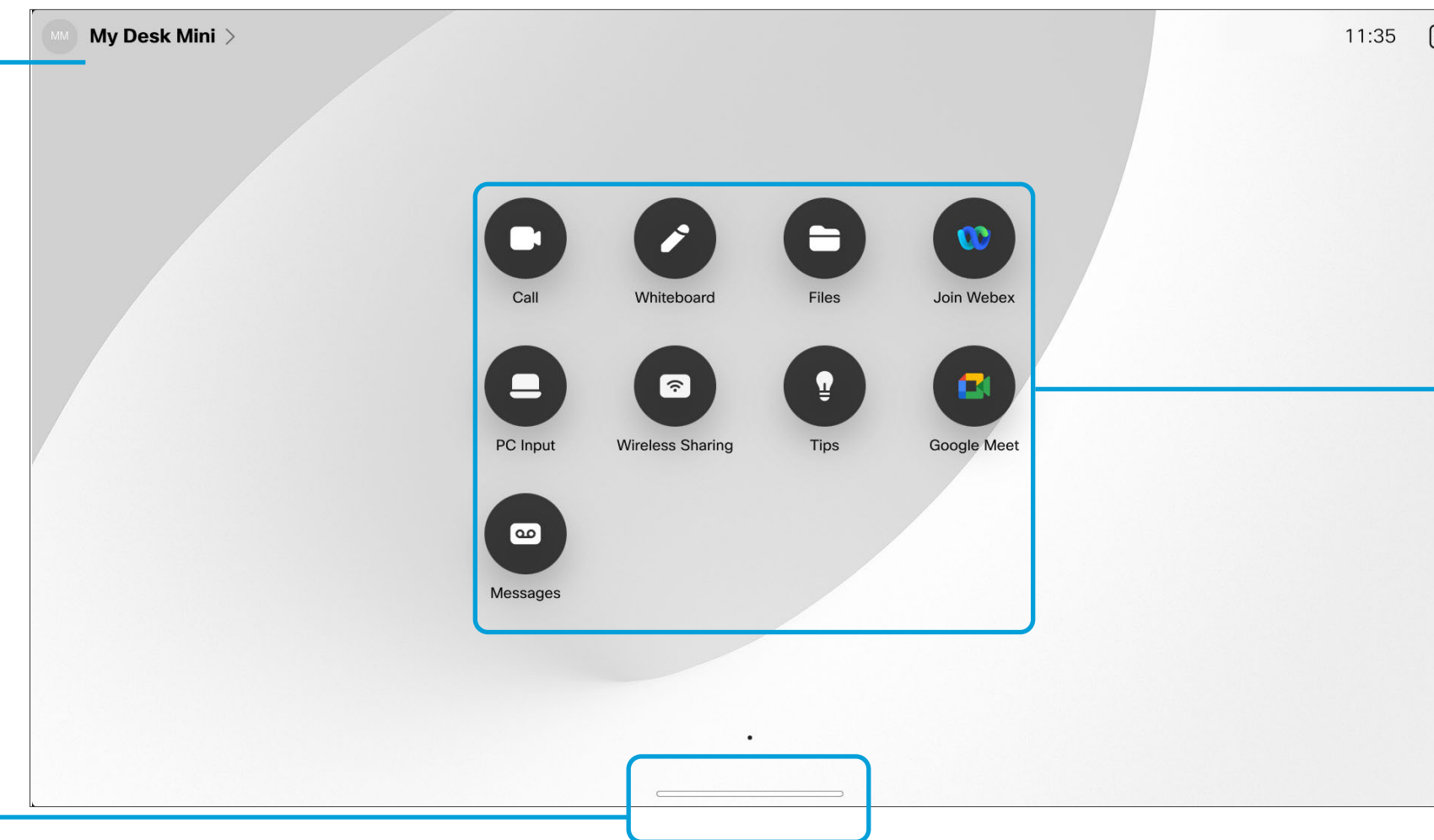

Dots under the buttons means there are more buttons off-screen. Swipe to see them.

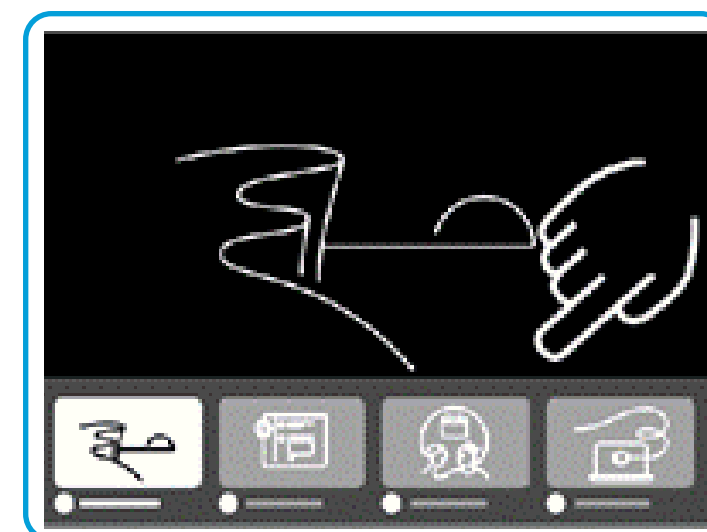

The task switcher shows any open apps, whether you're in a call or not. If your laptop's connected, its screen appears in the task switcher.

Whiteboards you create in a session are open as separate apps in the task switcher.

Tap the Files button to see all the whiteboards you've created on the device, and any other files that are available to you on your device.



Some apps open as dialogs. Touch and hold the top edge of a dialog to move it around. Tap outside a dialog to close it.

To close a full screen app swipe up from the bottom of the screen. Then swipe up on the preview image of the app you want to close.

RoomOS 11: Control panel and device settings

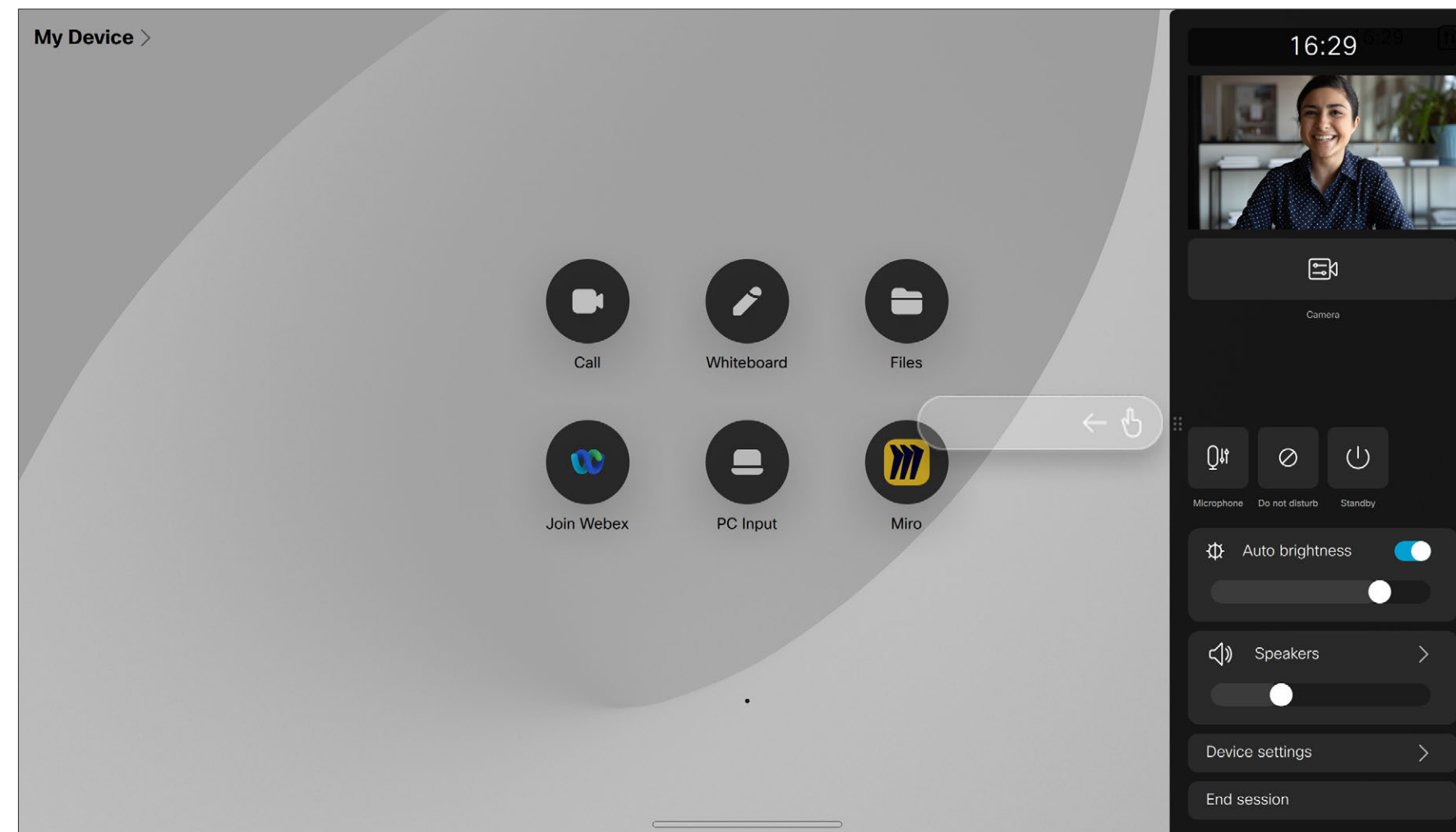

To open the control panel swipe from the right side of the screen, or tap the button on the upper right corner of the home screen. As long as your camera is open, you'll see your self-view at the top. In the Control panel you can find:

- Self-view
- Camera settings
- Microphone options
- Standby
- Screen brightness
- Device volume/speakers
- Access to device settings
- End session (when you have created whiteboards or annotations)

Microphone options

There are some new microphone options available with RoomOS 11:

- **Optimize for my voice.** Remove background noises during a call, only picking up your own voice and suppressing the voices of other people talking nearby.
- **Microphone testing.** Check that the Desk device is picking up your voice properly, and test the effectiveness of the noise removal setting.

Access device settings

From the **Settings** menu you can check device information and change several settings. Which settings are available may have been restricted by your administrator.

To open the Settings menu swipe right to access the control panel. Tap the **Device settings** button there. If you are in a call, the menu opens as a dialog on top of your call.

RoomOS 11: Video calls

To make a call, tap the Call button. Enter a video address or select to search for someone in your Favorites, Recents, or in the Directory.

Tap the screen to bring up the call controls during a call.

In addition to standard buttons like **Mute/Unmute**, **Volume**, **Start/Stop video**, and **Leave meeting**, all the other controls you need during your call are in the same place at the bottom of your screen.

- **Layout** menu. Choose a layout that fits your meeting style, and toggle **People focus** on and off.
- **Selfview**. Opens the manual camera controls and options to change and move your selfview.
- **Share**. See the next page.
- **Participants** list. Opens the list of people in the current call. Tapping a participant shows the options that are available to you – like mark as Favorite. Hosts/cohosts have additional options such as Remove from call, Admit, and muting options.

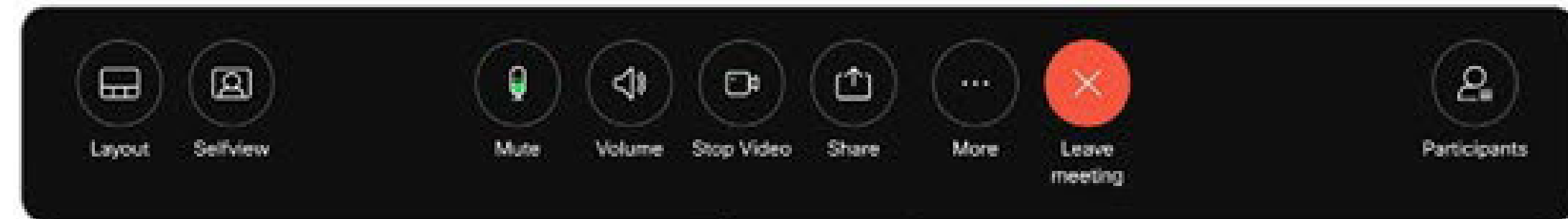

...More options

Tap **More** to get additional options during a call:

- **Lock meeting**
- **Microphone options**. Also available in the Control panel.
- **Add**. Lookup and add a meeting participant.
- **Keypad**

View your laptop screen in call

To use your Desk device as an extension for your laptop screen, connect your laptop with the HDMI or USB-C cable. You'll see the laptop screen in the task switcher.

To see your laptop screen during a call, select it in the task switcher. You'll see the call and presentation in a filmstrip. To make the laptop preview smaller and the call larger, drag down from the handle on top of the laptop preview. Tap and drag the filmstrip to change it to a small floating window which you can drag and drop on designated areas on the screen.

RoomOS 11: Content sharing

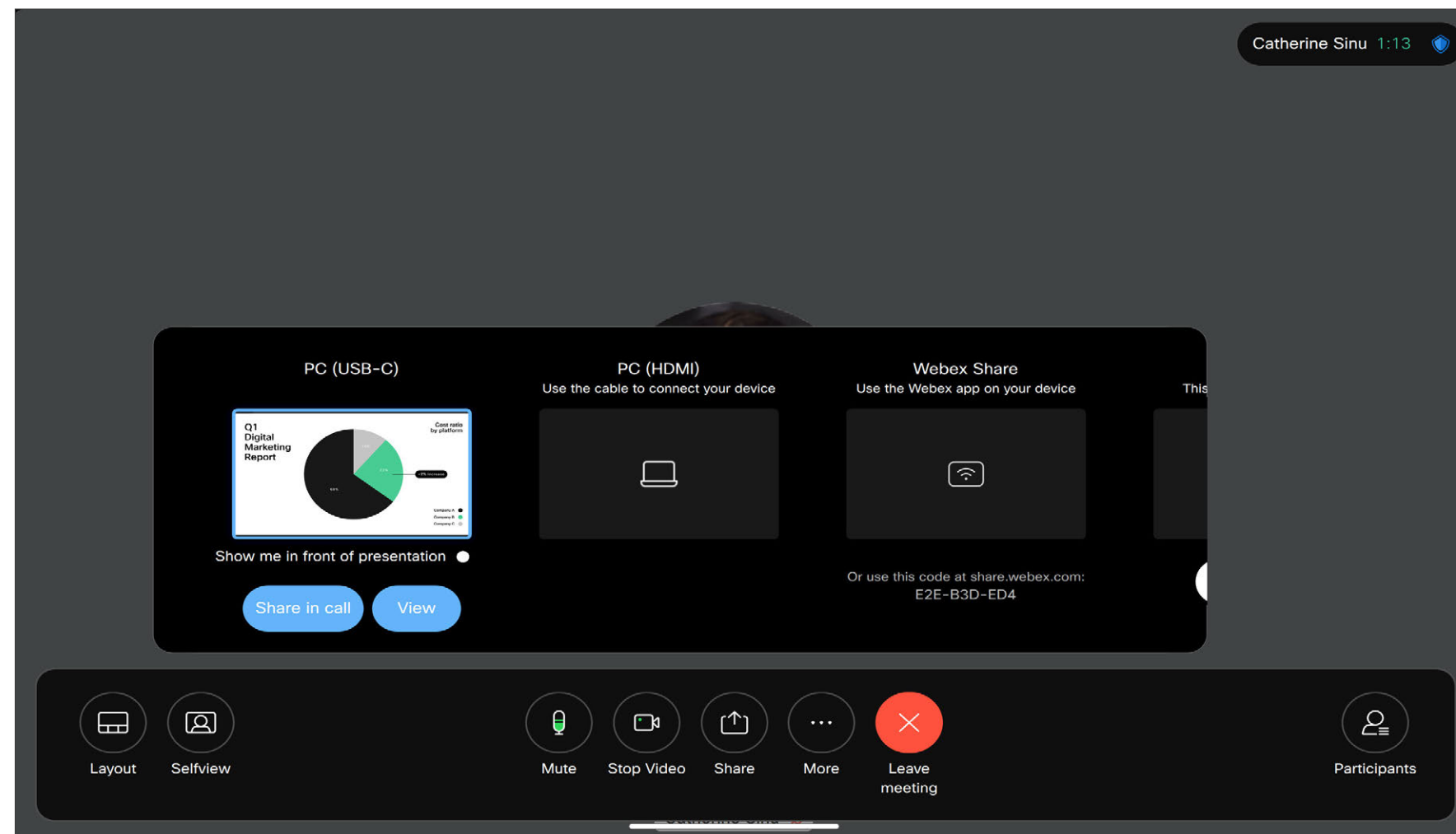

Show yourself in front of presentation

Show yourself in front of your shared content, just like when you are presenting in a meeting room. Your camera needs to be open for this option.

In a call, connect your laptop to your Desk device with the HDMI or USB-C cable. Tap the **Share** button in the call controls. Toggle on **Show me in front of presentation** and tap **Share in call**.

You can drag and drop your image on the screen to your preferred location, and pinch and zoom your image to change its size.

Tap the **Share** button in call, and a window opens. Select the source you're going to share from:

- Computer
- Proximity app
- Start sharing a new whiteboard
- Files from a Webex app space if a space is open on the device

Tap **Share now**. Tap **Stop share** on the screen when you're finished.

Pair with a Bluetooth® headset and other devices

You can use Bluetooth connection for both headsets and other devices. For headsets, you can use Bluetooth to either connect directly to a headset or through a USB dongle.

You can switch between the speaker of the Webex Desk or Desk Pro and the devices connected through Bluetooth or USB. Select the icon in the status bar of the user interface, and choose from the available devices.

NOTE: You can't have both a headset and another Bluetooth device connected simultaneously.

Bluetooth headsets

Bluetooth profiles supported:

- HFP (Hands-Free Profile)
- A2DP (Advanced Audio Distribution Profile)

Bluetooth headset is supported directly with the embedded Bluetooth radio or by using a USB Bluetooth dongle.

Multiple headsets can be paired with the device, but only one can be connected at a time.

The range is up to 10m (30ft). If you move outside the range when in a call, the audio switches to the speakers on the device.

Most headsets have built-in volume controls. When in a call, the volume of the headset and device is synchronized. When not in a call, the volume buttons on the headset and device operate independently.

Supported Bluetooth features:

- Answer incoming calls
- Reject incoming calls
- Hang up calls
- Hold and resume calls
- Volume up and down

Some headsets have mute control. This operates independently of the mute control on the device.

The Bluetooth® word mark and logos are registered trademarks owned by Bluetooth SIG, Inc. and any use of such marks by Cisco is under license. Other trademarks and trade names are those of their respective owners.

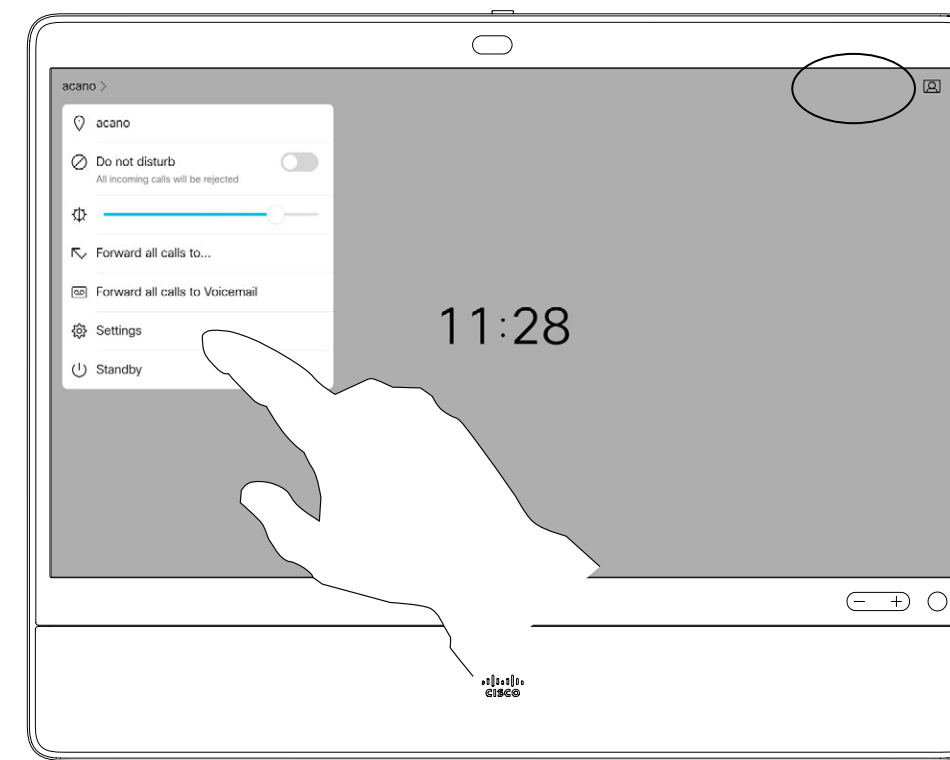

Icon appears here. Tap it to change between desk device speakers and another device.

- 🔊 Speakers
- 🎧 Analog headset
- 🎧 USB headset
- 📞 USB handset
- 📶 Bluetooth device

Pair a Bluetooth headset

1. Activate Bluetooth pairing on the headset. If in doubt, consult the instruction manual for the headset.
2. Tap the device name in the upper left corner of your desk device, tap **Settings** and **Bluetooth**. If Bluetooth is disabled, turn it on. Bluetooth is enabled by default.
3. The desk device scans for other devices. Upon successful discovery the Bluetooth headset should be displayed in the device list.
4. Select the device and pairing begins. It may take a few seconds for the pairing to complete.
5. If the pairing is successful, desk device lists the headset as connected. The pairing is completed.

USB Bluetooth dongle

When using the dongle the headset is detected as a USB headset.

Note that synchronization of headset volume and device volume doesn't work when using a dongle.

See also <https://help.webex.com/nkiifbo/>.

Pair other devices

You can also pair other devices to your Webex Desk or Desk Pro, such as your mobile phone for listening music.

NOTE: You can't use Bluetooth to stream music while in a call.

1. Tap the device name in the upper left corner of your desk device, tap **Settings** and **Bluetooth**. If Bluetooth is disabled, turn it on. Bluetooth is enabled by default.
2. Toggle on **Discoverable**.
You only need to set the desk device as Discoverable when you connect a new device. The desk device goes automatically out of Discoverable mode after five minutes.
3. Go to the Bluetooth settings on your device and scan for available devices.
4. Select Webex Desk or Desk Pro from the devices list and pairing begins. It may take a few seconds for the pairing to complete.
5. If the pairing is successful, your Webex Desk or Desk Pro is listed as connected. The pairing is completed.

Audio settings

Noise Removal

You can use noise removal to filter out distracting noises from your environment in a call. Noise removal is specially useful in a shared spaces or a home office.

On your Desk Pro, tap the microphone icon on the top right of the home screen. Tap **Noise Removal** to turn it on.

To turn off, tap **Default**.

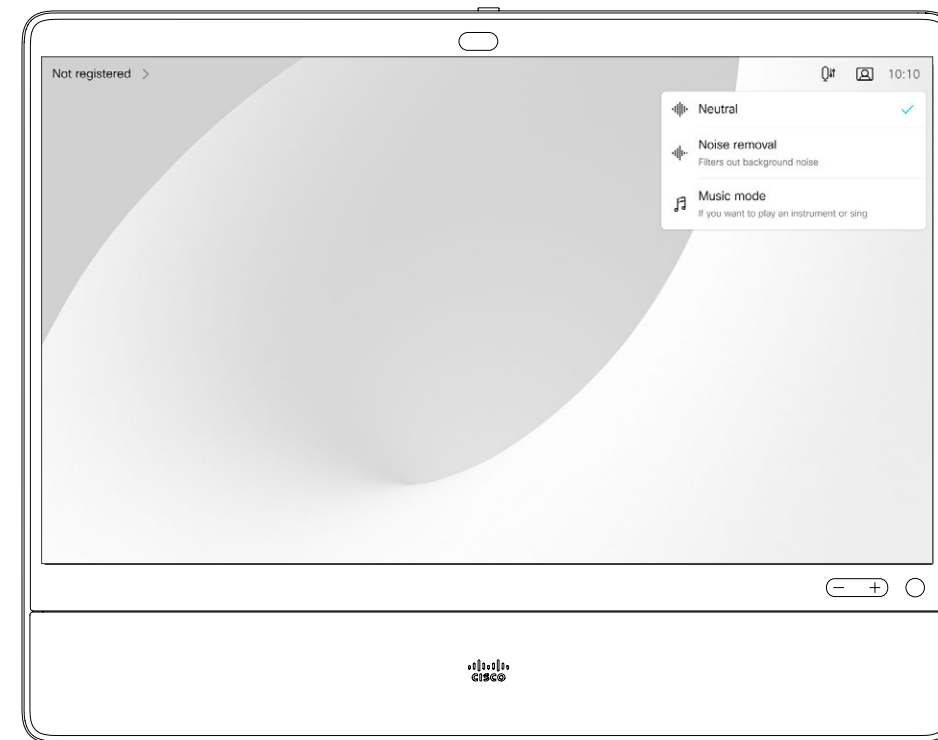

Ringtone and Volume

To change the ringtone and to adjust the ringtone volume, tap the device name on the home screen and select **Settings**. Go to **Ringtone and volume**. Select a ringtone from the list and use the slider to set the sound level.

Use as a USB camera

The Cisco Webex Desk or Desk Pro may also be used as a USB camera.

If you did not register your Webex Desk or Desk Pro with Cisco, you may use it as any other USB camera.

If you have registered the Webex Desk or Desk Pro with Cisco, you can still use it as a USB camera, but kindly observe the following:

- The Webex Desk or Desk Pro will enter do not disturb (DND) mode when the software client starts using the camera, and not when the cable is plugged.
- This will allow scenarios where a dedicated computer is connected to the device at all times, but the desk device can be still be used for regular Cisco calls.

To use the Webex Desk or Desk Pro as a USB camera, connect it via a USB cable between your computer and the USB-C socket on the Webex Desk or Desk Pro.

This configuration will make use of the microphones and the loudspeakers of the Webex Desk or Desk Pro, ensuring a great sound experience.

If you want to extend the configuration to include an external monitor with this setup, connect your computer to the monitor in your usual way.

Other Device Settings are also fully accessible, with the exception of the Do Not Disturb, which cannot be disabled on a Cisco registered Webex Desk or Desk Pro.

Used as USB Camera When Already Registered

When placing calls using a third party client, the camera, microphone and loudspeakers are selected based on the OS/app. defaults. You may override these settings.

To maintain privacy, the camera light indicator will be illuminated whenever the camera is active.

All other functionality is controlled by the third party client.

Used as USB Camera When Not Registered

The first time you start up a Cisco video device, the Setup Wizard will appear.

This wizard lets you specify how to register with Cisco Services (Cloud or on-premises). The Webex Desk or Desk Pro provides the option of skipping the wizard if you are going to use it as a USB device only.

Detailed instructions are provided on-screen to show you how to do this.

If you later want to register the Webex Desk or Desk Pro with Cisco, go to **Settings** and select **Device Activation**.

Sign in with your own credentials

About Extension Mobility

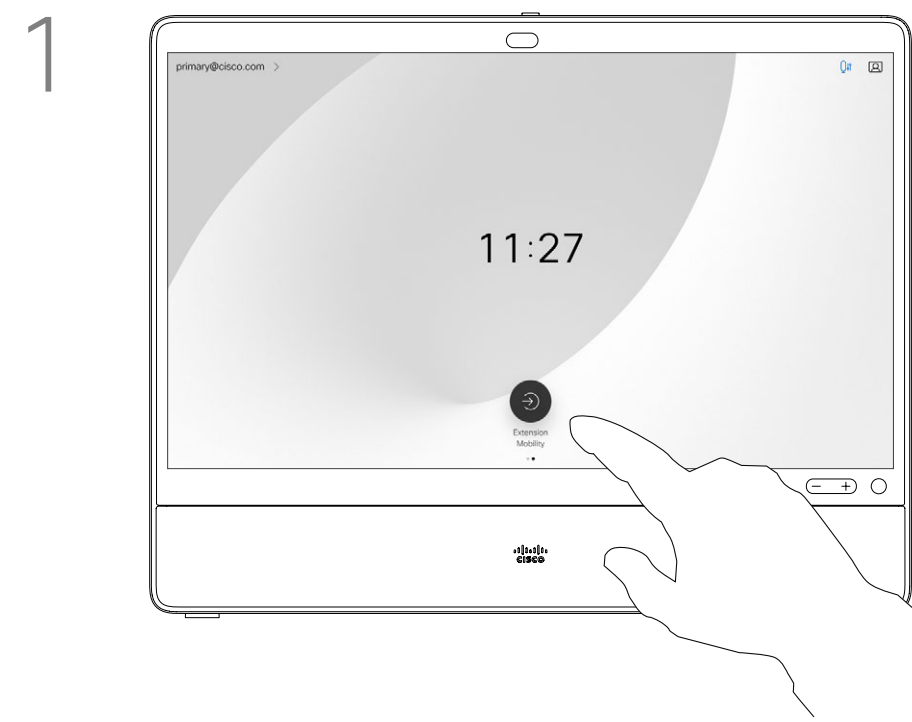

1 Tap the green **Extension Mobility** button.
If you can't see the button, swipe the home screen buttons to left.

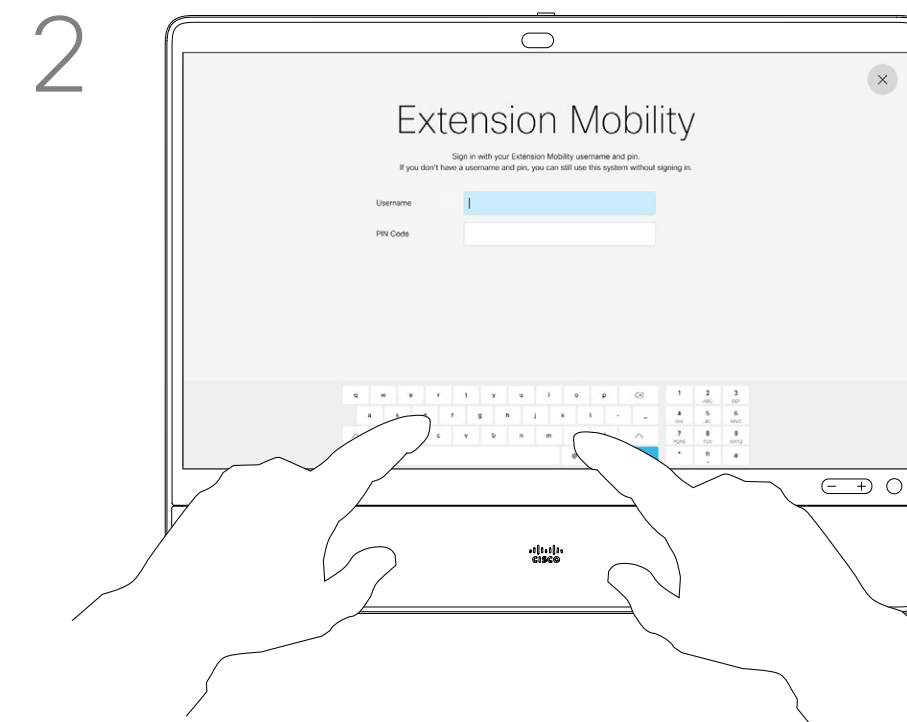

2 Key in your Username and PIN Code.

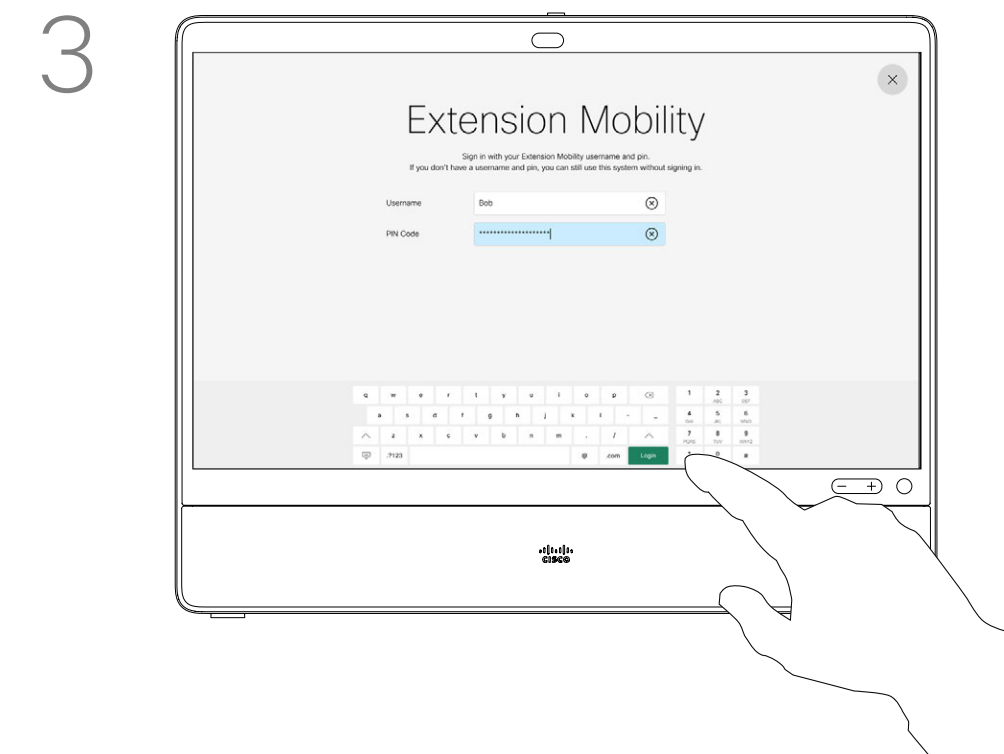

3 Tap **Login**.

Devices located in meeting rooms and quiet rooms and running under CUCM (Cisco Unified Communications Manager) may allow you to log in to the device with your own personal credentials.

CUCM then routes all of your incoming calls to that specific device.

Once you log out from Extension Mobility, your list of Recents is cleared from the device.

Extension Mobility is also referred to as Hot-desking.



4 You can see a conformation that your Sign in was successful.

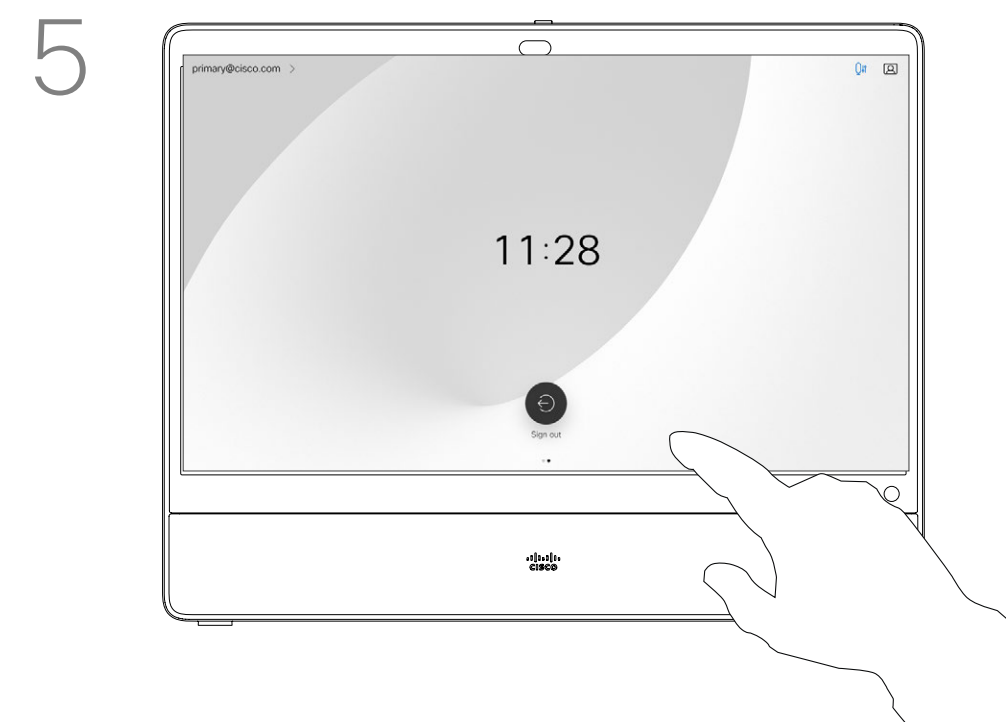

5 To log out again, tap **Sign out**, as shown.
If you can't see the button, swipe the home screen buttons to left.



Video calls

Place a call from contact list

About the lists of contacts



Tap the green **Call** button.



To search for someone in a specific list (*Favorites, Directory or Recents*), tap that list and then scroll down to locate the entry to be called.

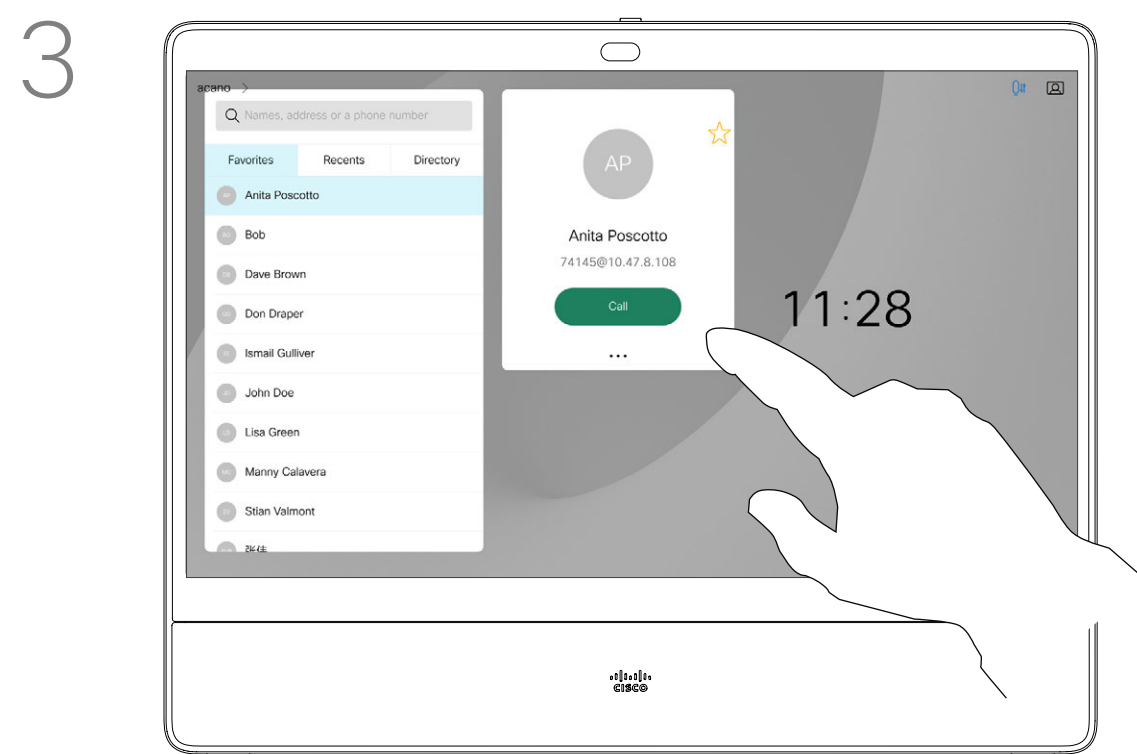

Tap that entry to produce the green **Call** button. Then tap the green **Call** button, as shown.



The call is placed. To end the call, tap the red **End Call** icon.

Your lists of Contacts consist of three parts:

Favorites. These contacts are put there by you. These entries are those you call frequently or otherwise need to access in a swift and convenient manner from time to time.

Directory is typically a corporate directory installed on your device by your video support team.

Recents is a list of calls you have placed, received or missed earlier.

The following options apply:

- You may key in a name, number, or an IP address and the device looks in all lists for you.
- You may add the entry to the list of *Favorites*; edit aspects of the entry before calling and change the call rate.

Note that removing entries from *Recents* can only be done from the web interface.

Edit a contact before calling



Locate the entry to be edited before a call is placed. Tap that entry. This opens the *Call* menu.

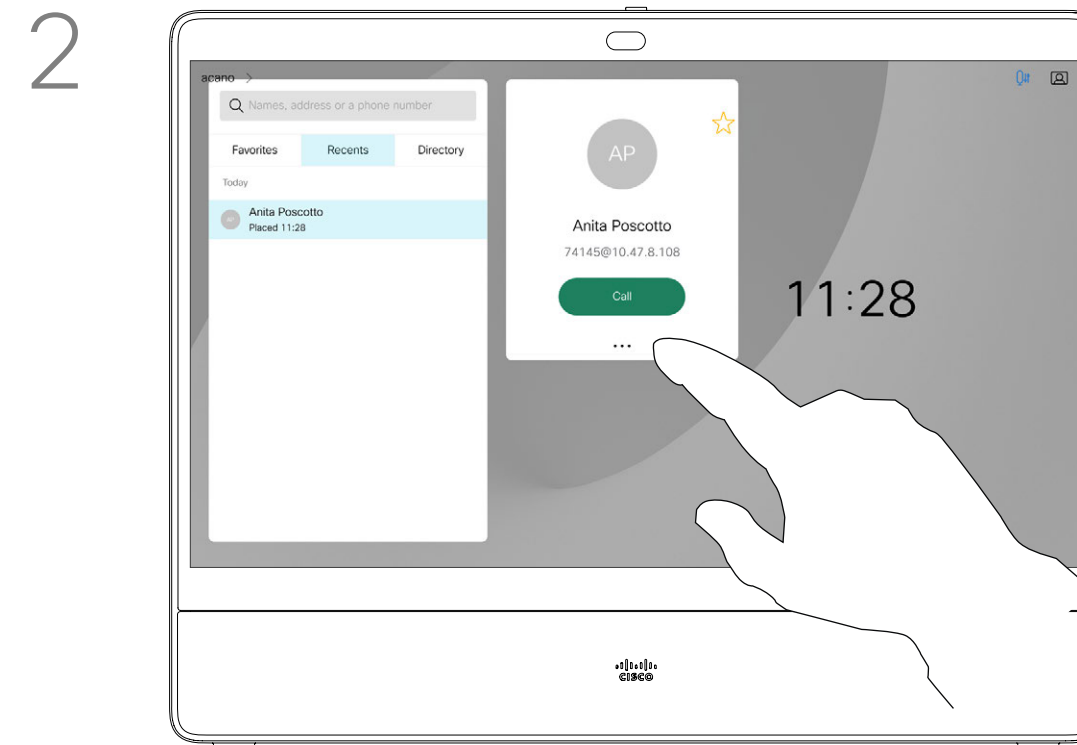

Tap the **More (...)** icon just below the green **Call** button.

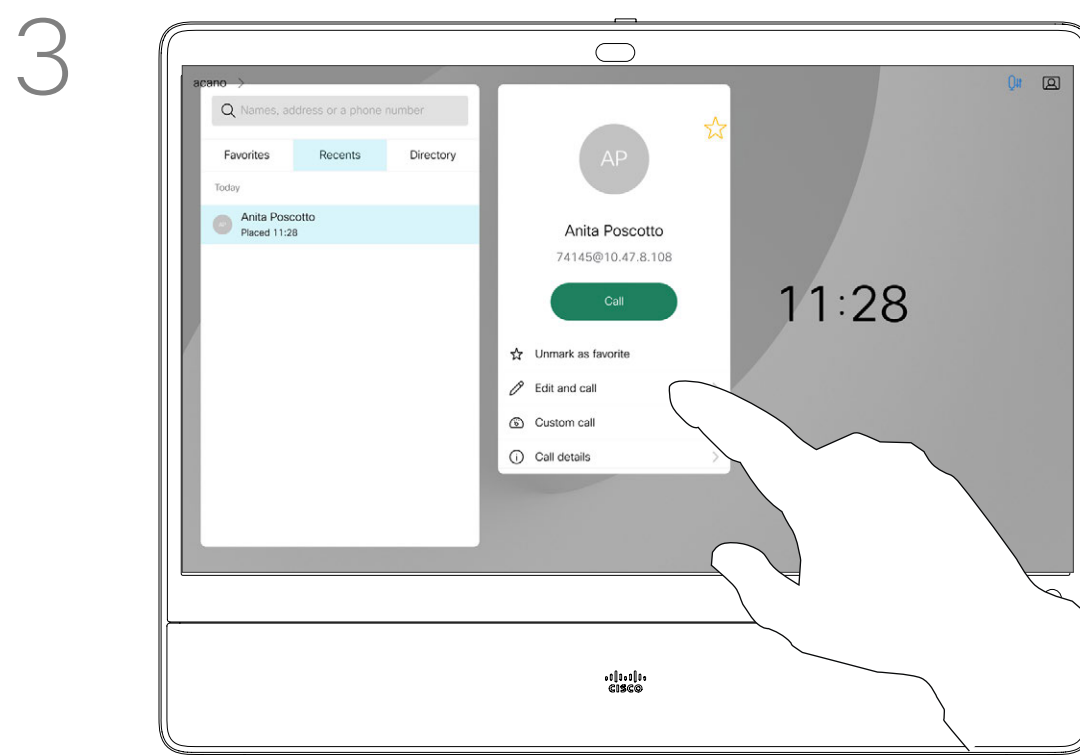

Tap **Edit and Call**.



Use the keyboard to edit and then tap either of the green **Call** buttons to place the call.

For how to enter the Contacts list, see the previous page.

You may have to edit an entry in one of the Contact lists before you place the call. There may be a need to add a prefix, a suffix, or otherwise alter the entry to ensure success.

Place a call using name, number, or address

About placing calls

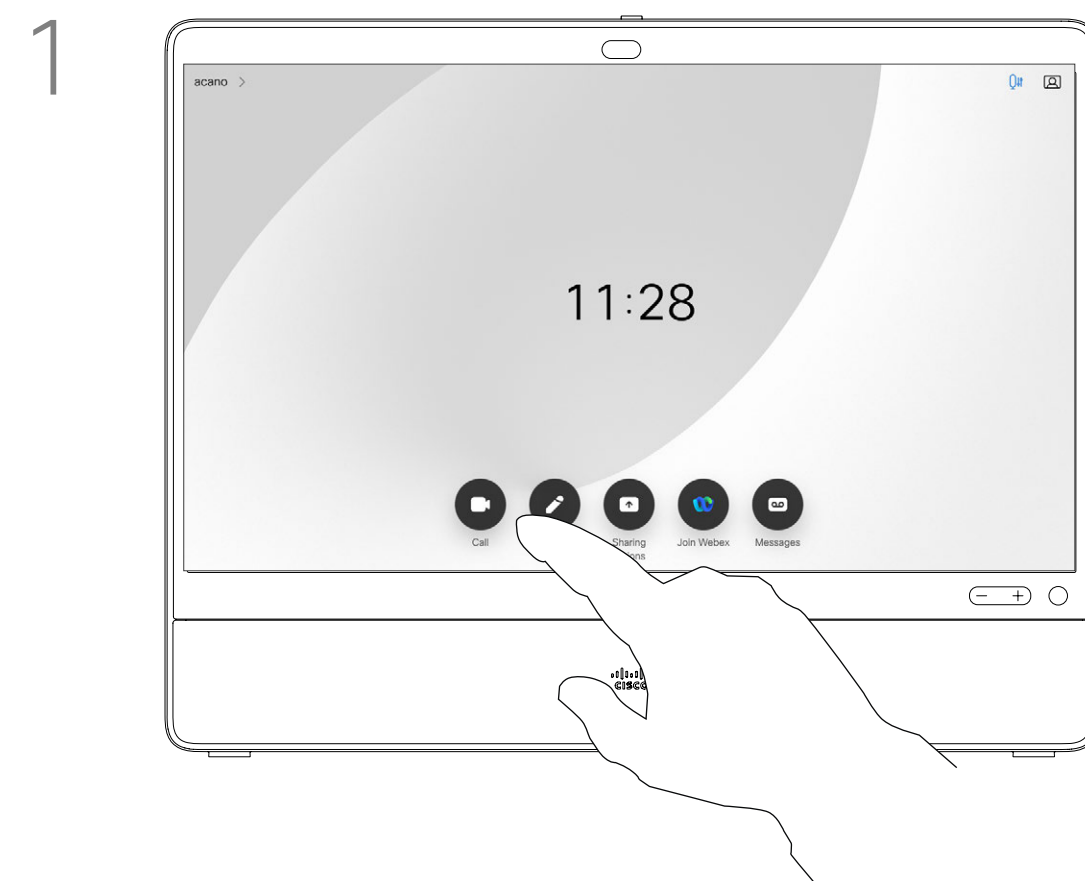

Tap the green **Call** button.



Tap the **Search or Dial** field. This opens the keyboard



Key in a name, number, or address. Matches and suggestions appear as you type. If the correct match appears, tap that match, otherwise keep typing.



When you have typed or located whom to call, tap either of the green **Call** buttons to place the call.

You may call someone who is not listed in your list of contacts by keying in their name, address or number using the virtual keyboard appearing on the display.

Anyone you have previously called, or who has called you, appears in the *Recents* list and you may transfer any of them to your list of *Favorites*. This is described in the section *Contacts*.

Sometimes you need to enter numbers during a call, typically to reach extensions or to provide a pin code.

Tap **Touch Tones** (this button appears as soon as the call is placed) to invoke the keypad needed for this.

Note that Recents can be cleared from the web interface only.

Video calls Incoming calls

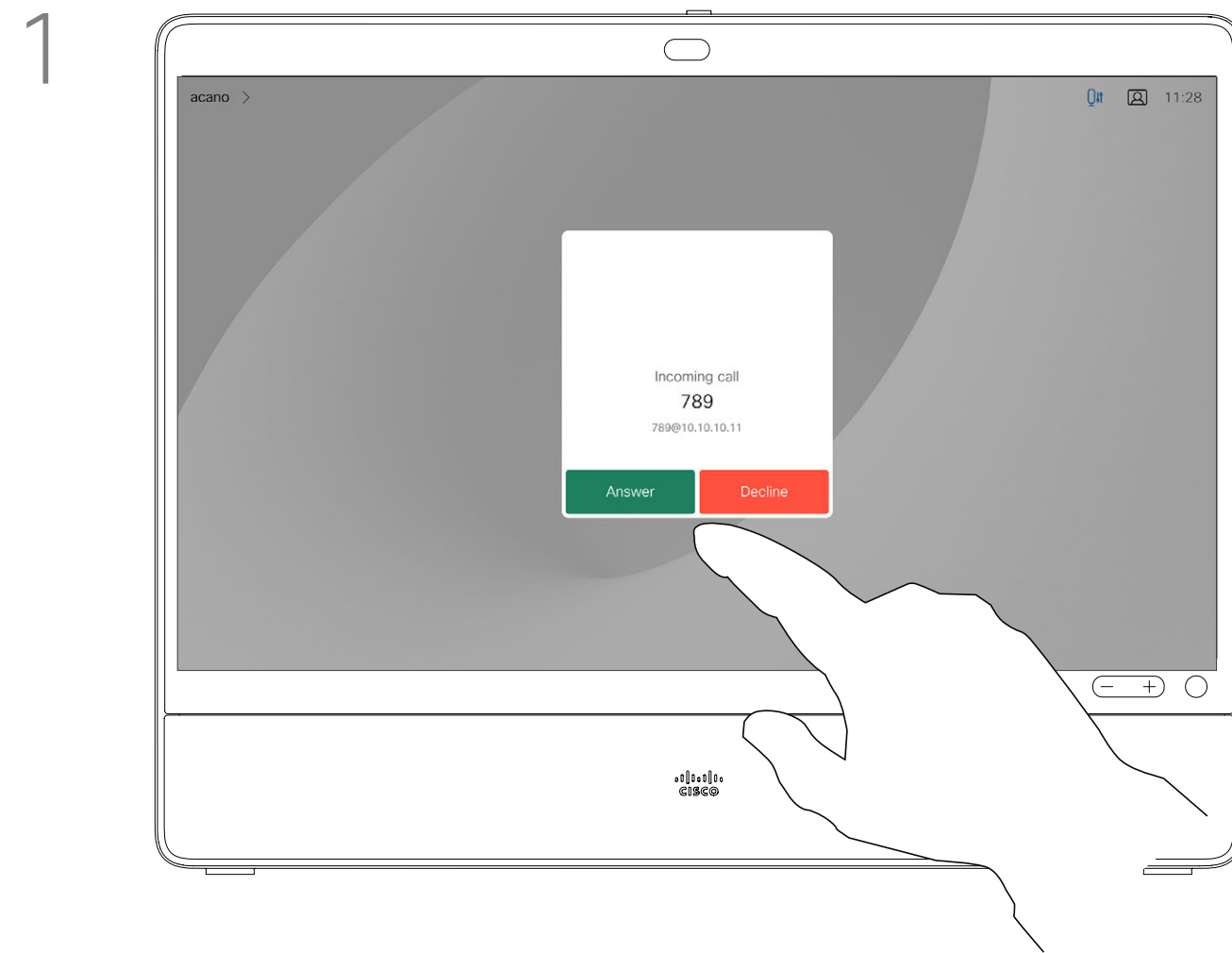

Tap accordingly to accept (answer) or decline an incoming call.

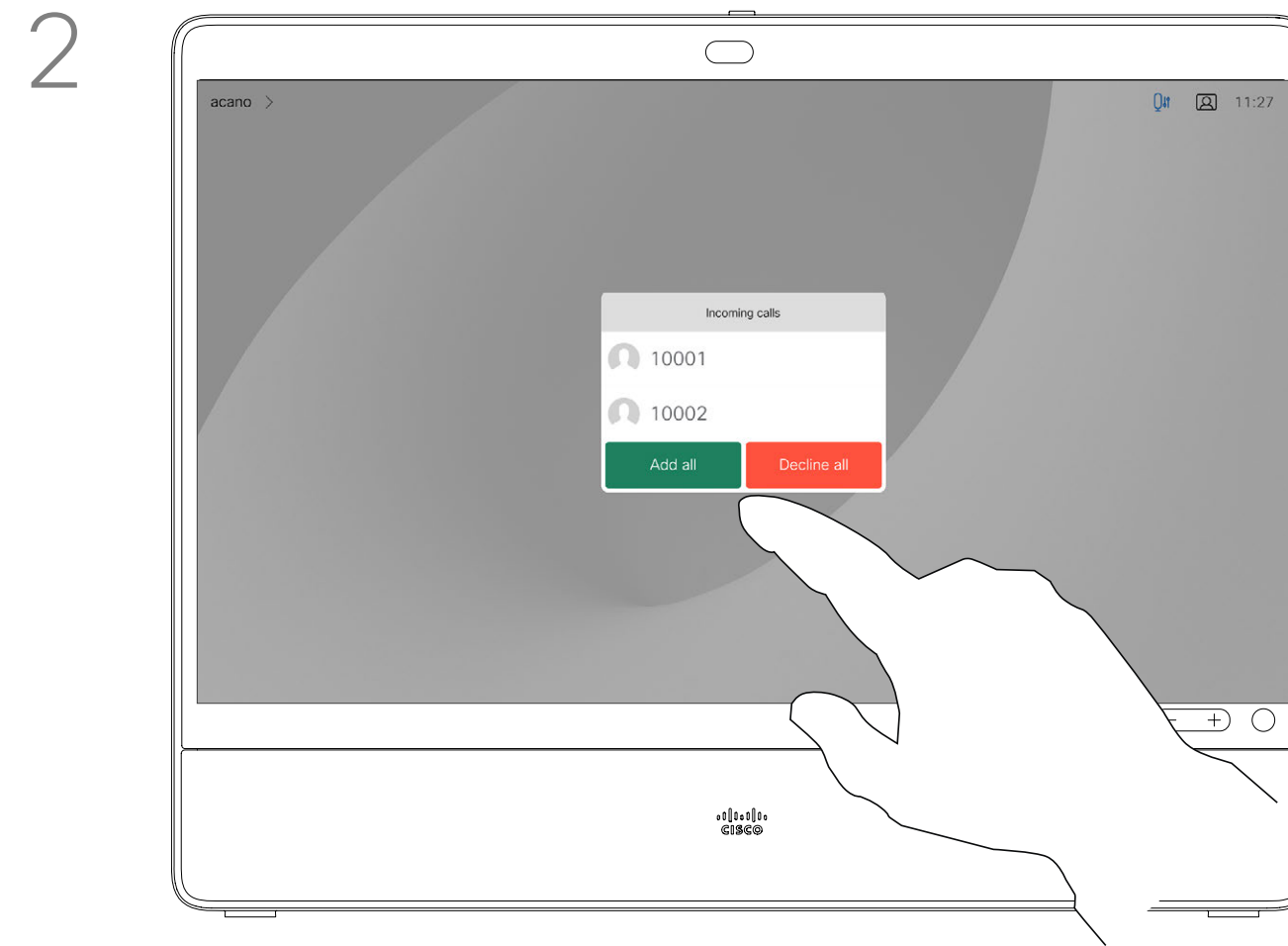

If your video infrastructure permits it, you may receive multiple incoming calls. You then have the choice to add them to an existing call, or decline them.

If someone calls you

- If someone calls you, you may accept, decline, or ignore the call.
- If you decline the call, busy information is sent to the caller.
- If you ignore the call, the caller perceives this as if you were absent (you didn't pick up the call).
- Your video infrastructure may allow you to receive multiple incoming calls. Consult your video support team, if needed.

Receive a call while in another call

About the options

If you already are in a call, you may accept another incoming call under certain circumstances.

Add: If your device is running Ad-hoc conferencing under CUCM you can add incoming participants.

The identity of the new incoming call.

Decline the incoming call and carry on as you have been doing.

Accept & Hold: Answer the call and put the existing call on hold.

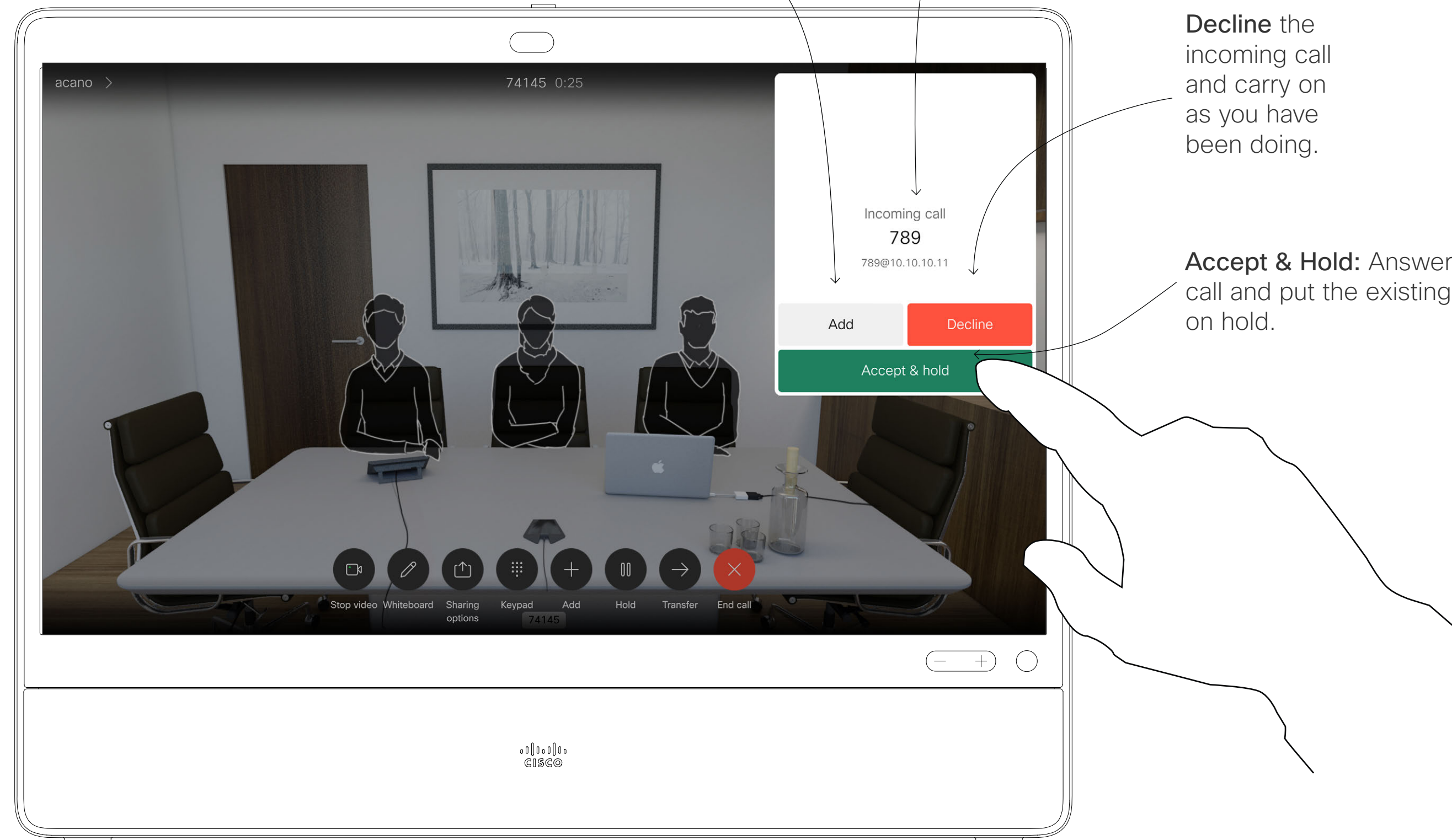

Video calls

Disconnect yourself from a call

About disconnecting yourself

Tapping **End** in a call disconnects you from a call. In a call with two parties only, this terminates the call.

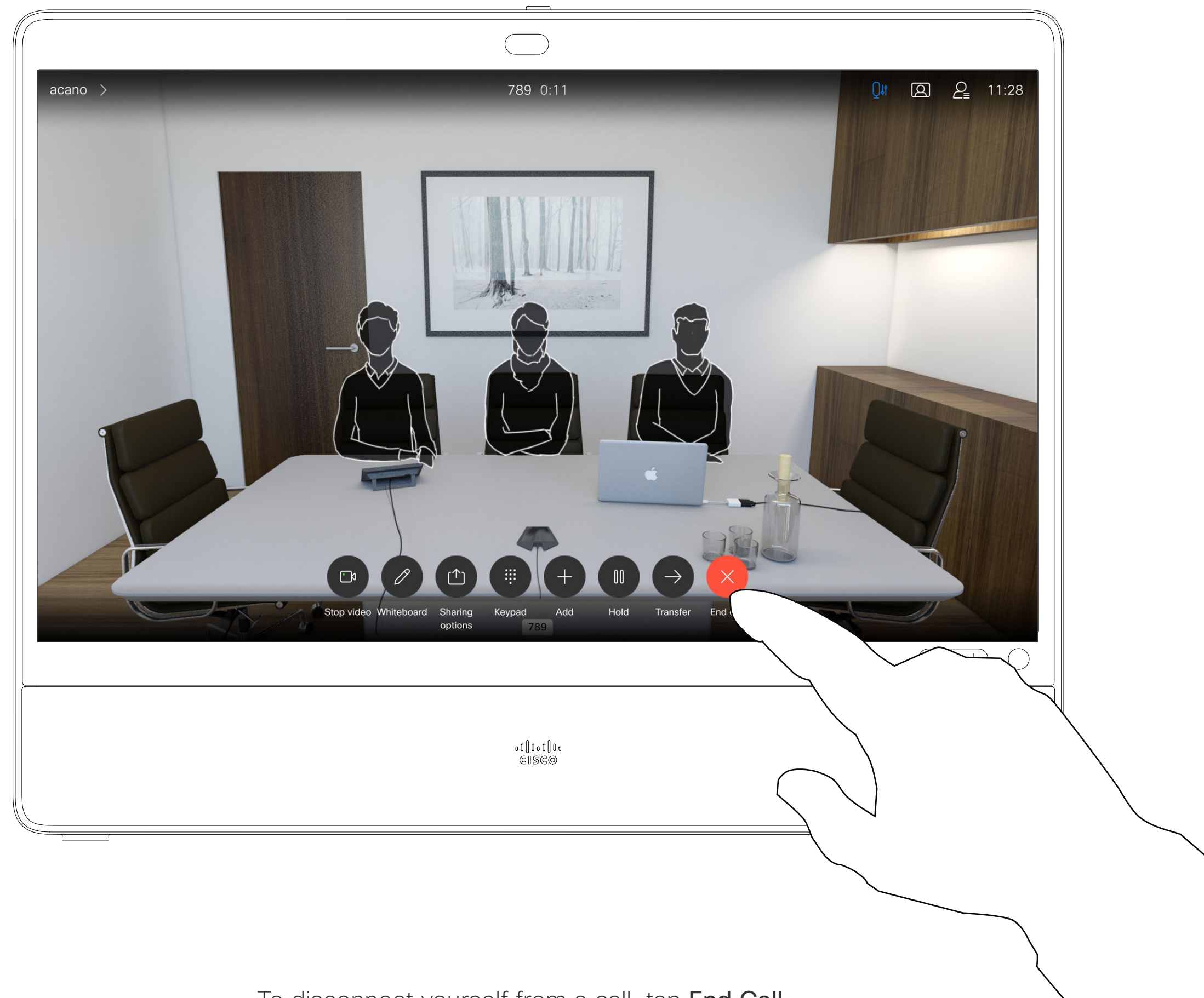

To disconnect yourself from a call, tap **End Call**.

Put call on hold and resume a call on hold

About putting on hold

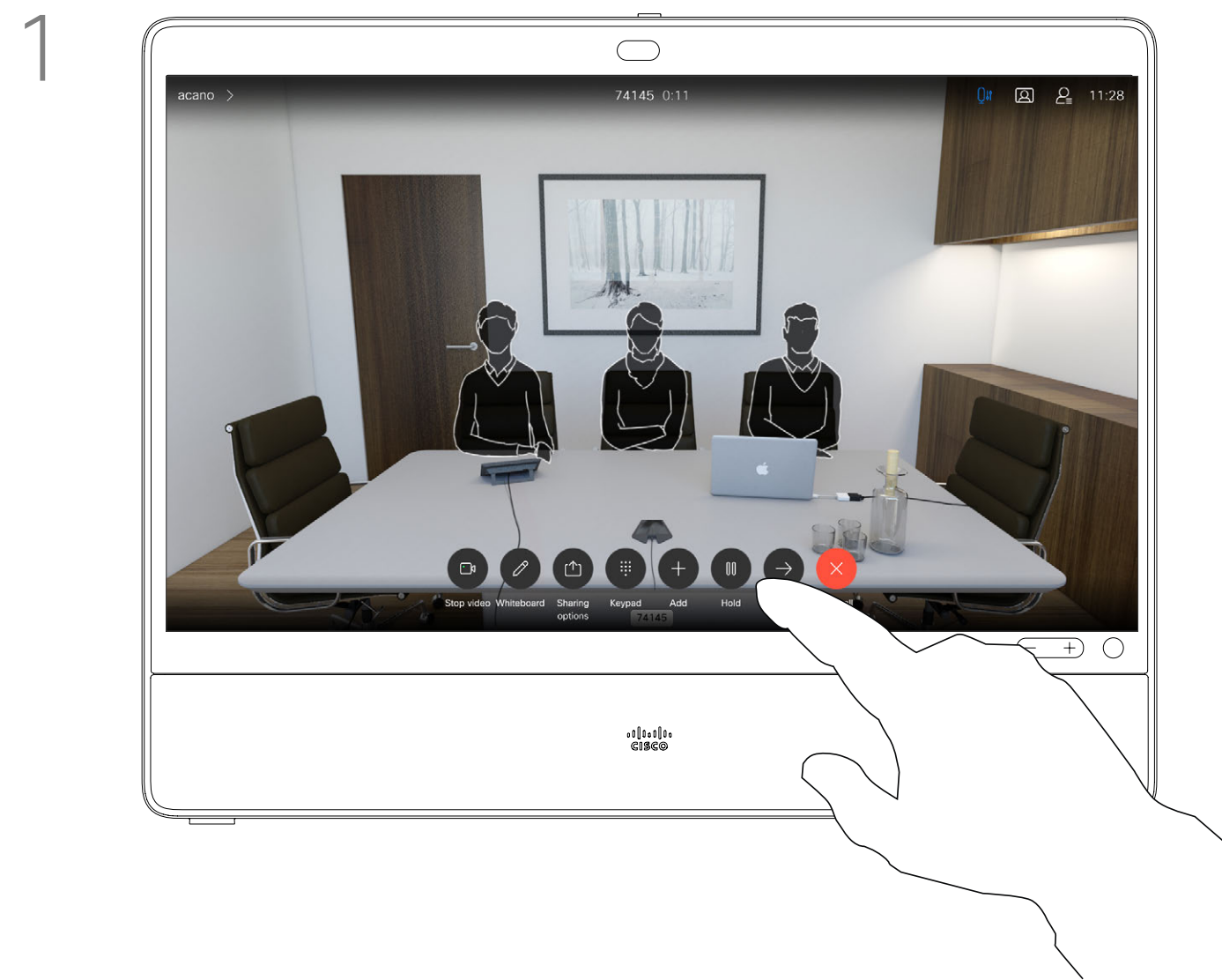

In a call, tap **Hold**.

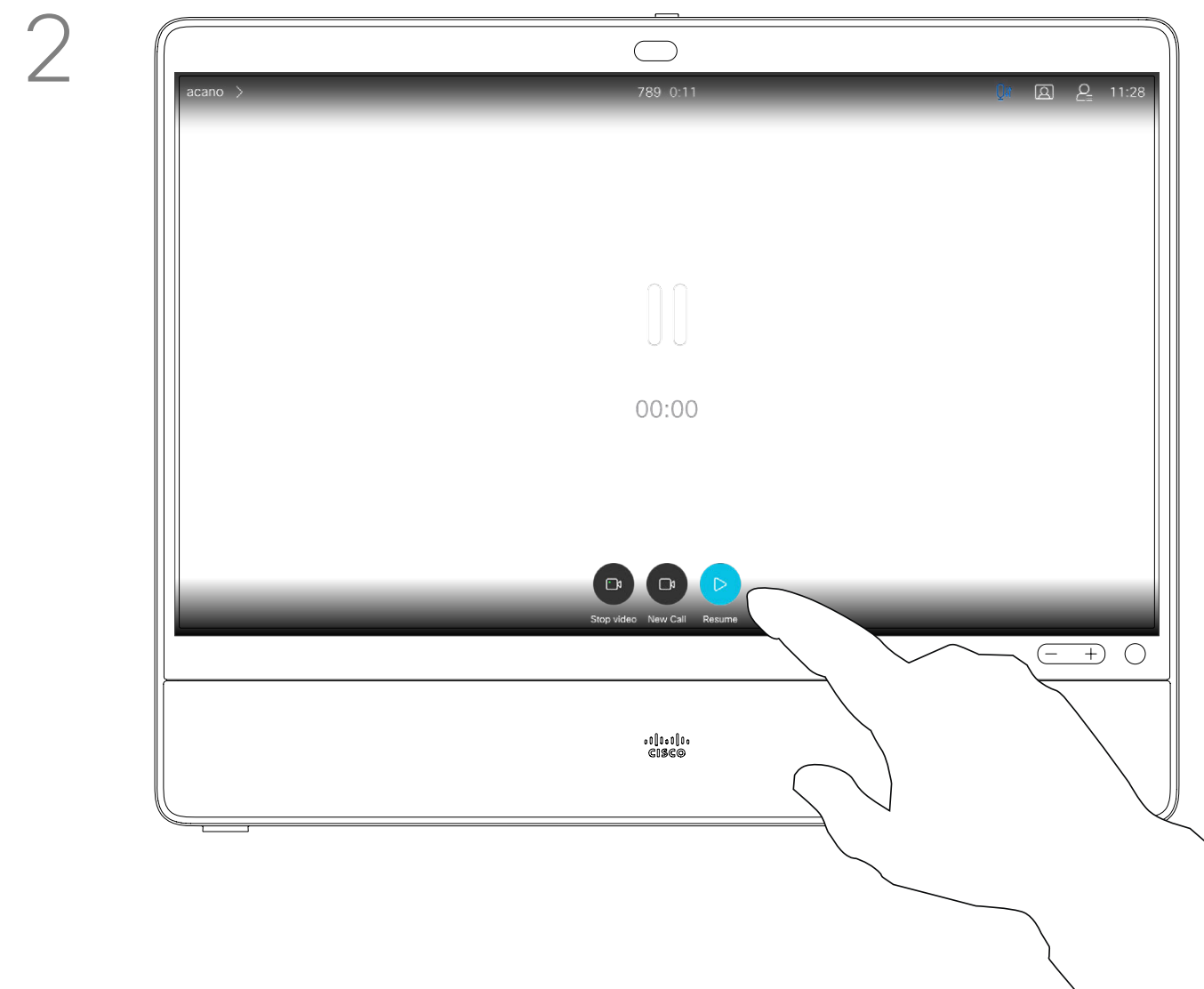

Tap **Resume** to go back to the one you were in call with (to undo your action).

Putting someone on hold is typically something you do as an initial step when transferring someone to another person. It can also be used when you need to consult a person, or as an alternative to muting when you want to also stop the video transmission.

Transfer an ongoing call

About transfer

You may transfer an ongoing call to another person. Transfer is always consultative and you can talk to the person you are going to transfer a call to, before you actually transfer the call.



Tap the **Transfer** button. This puts the current call on hold.

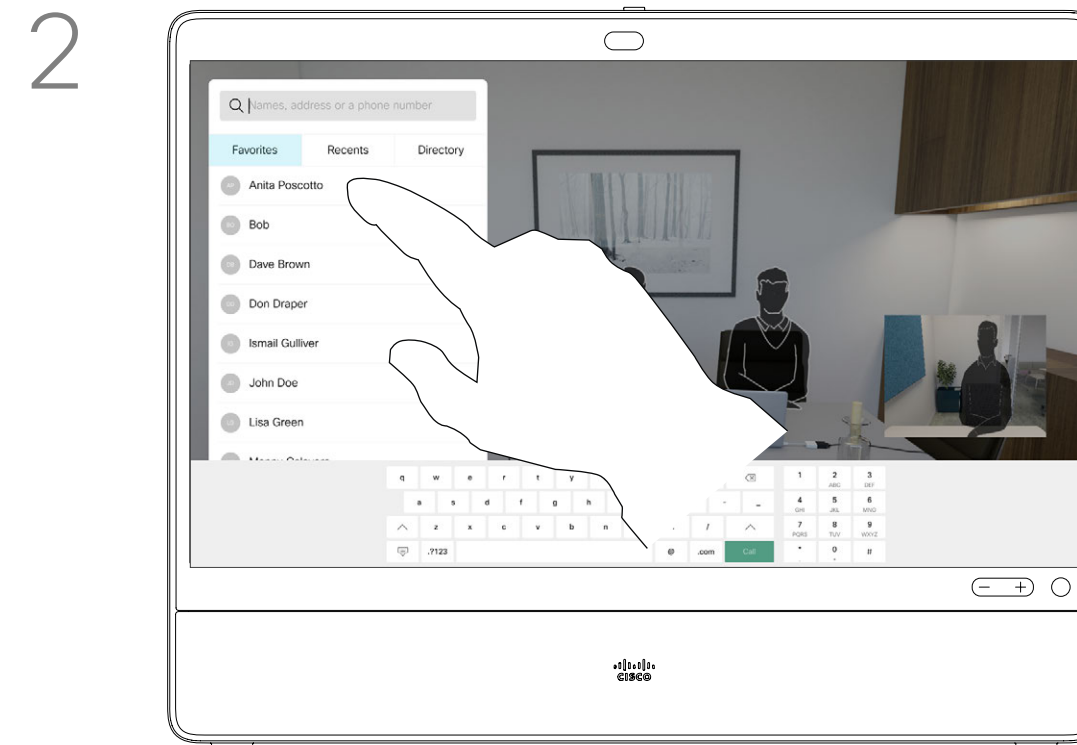

Search for whom to call in the usual way.

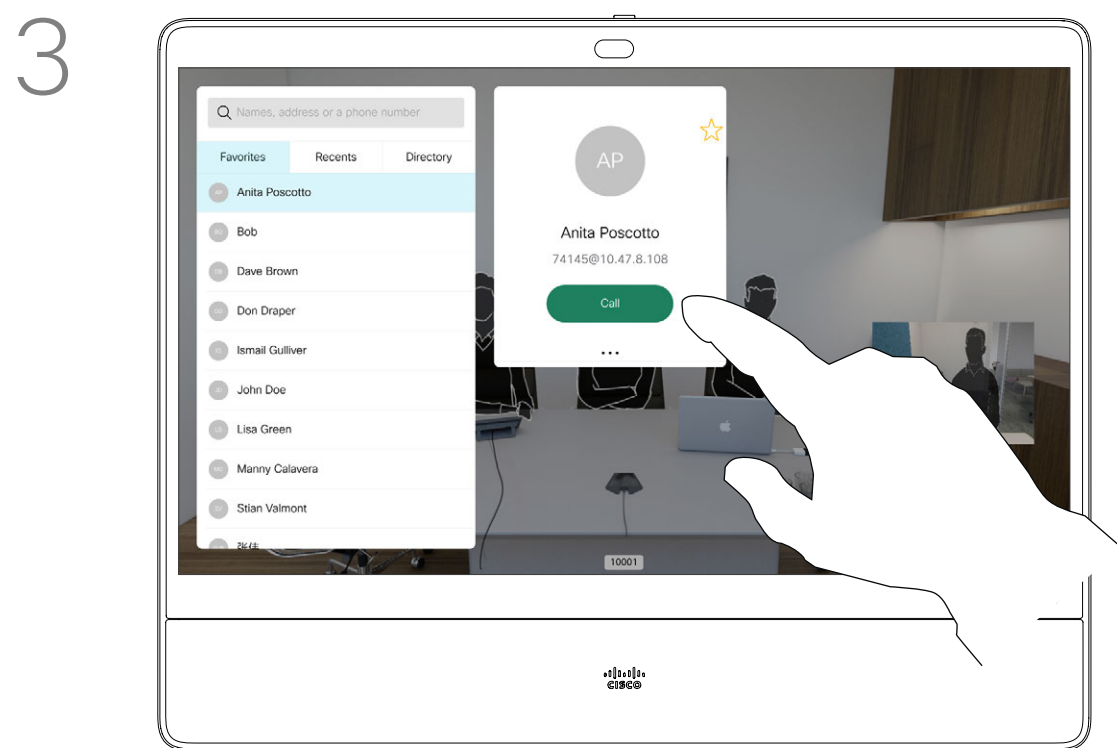

Tap the green **Call** button. Talk to the person to confirm that transfer is OK. The person to be transferred is still on hold.

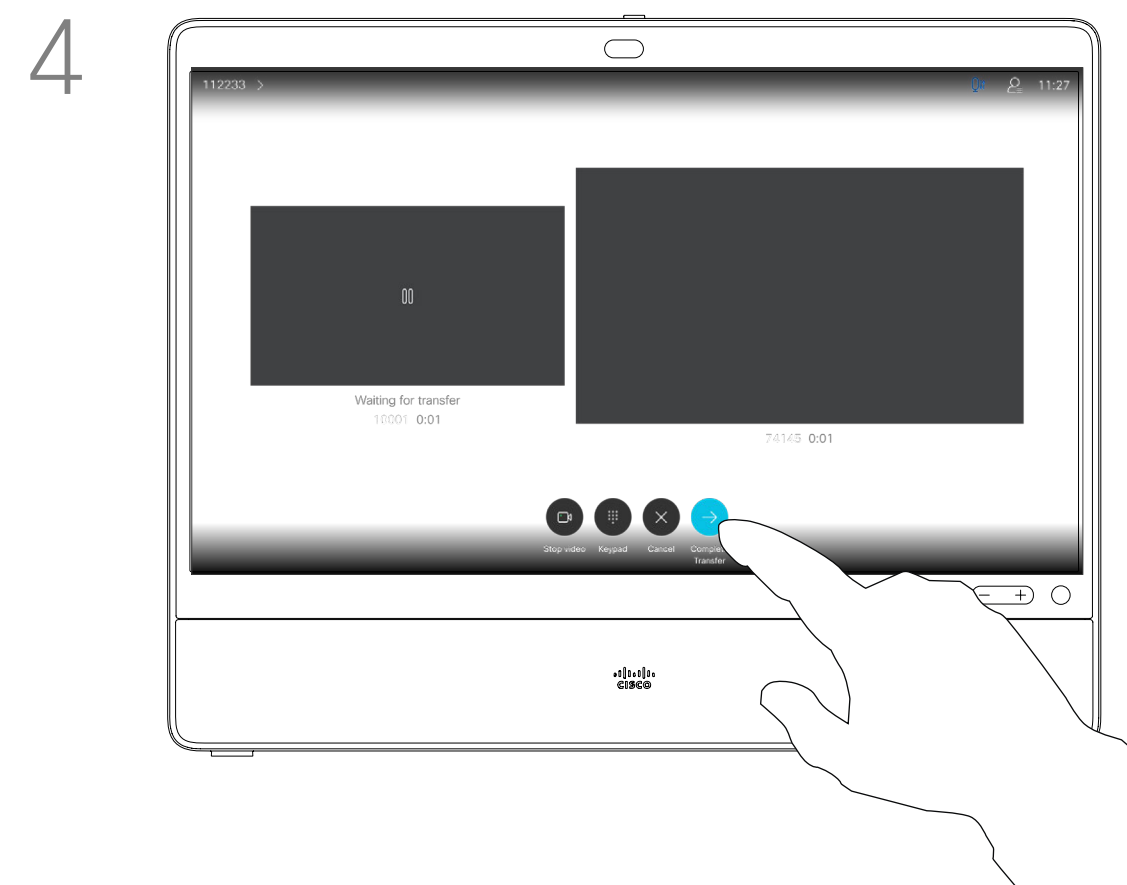

Tap **Complete Transfer**.

Change the call rate

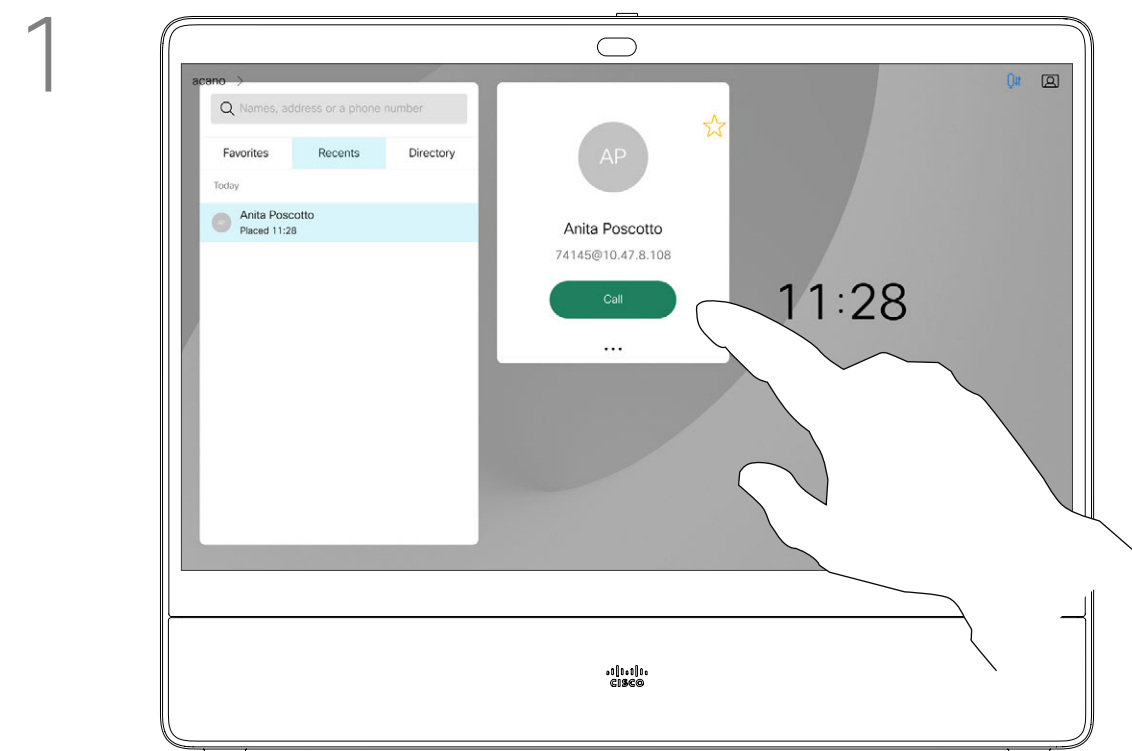

Tap the **Call** button (not shown), then locate the entry whose call rate you want to alter (not shown). Tap this entry to produce the *Call* menu and then tap the **More (...)** icon below the green **Call** button, as shown.

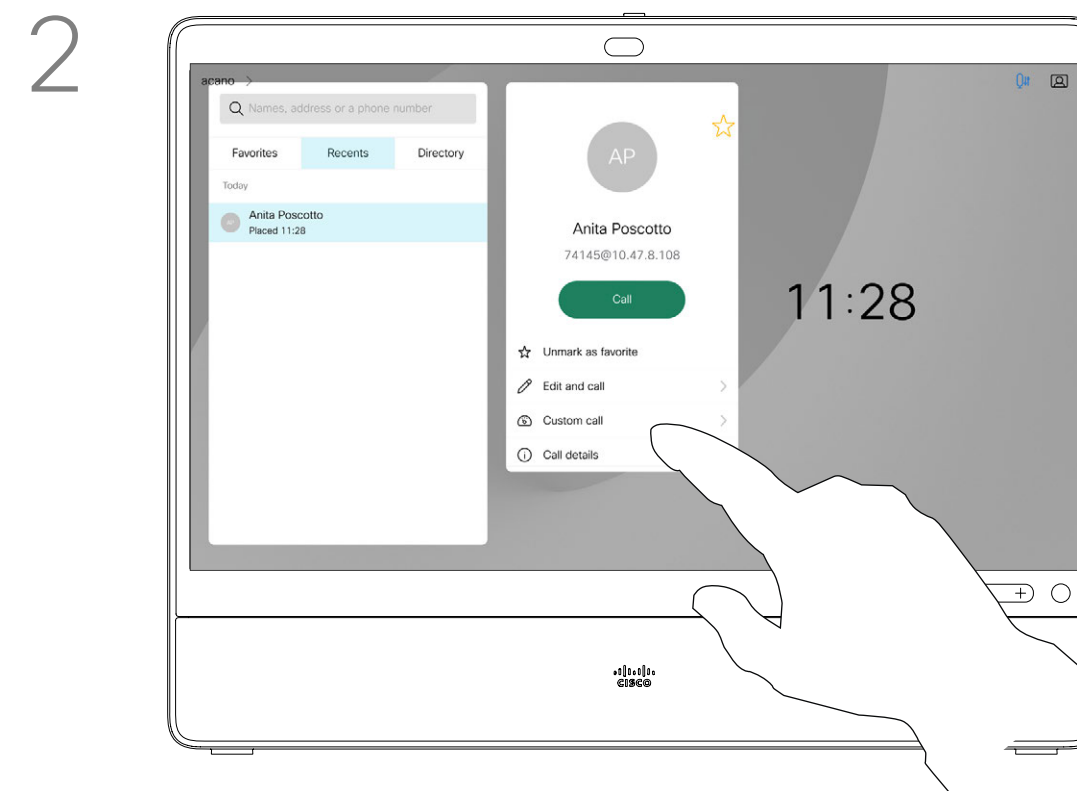

Tap **Custom call**.

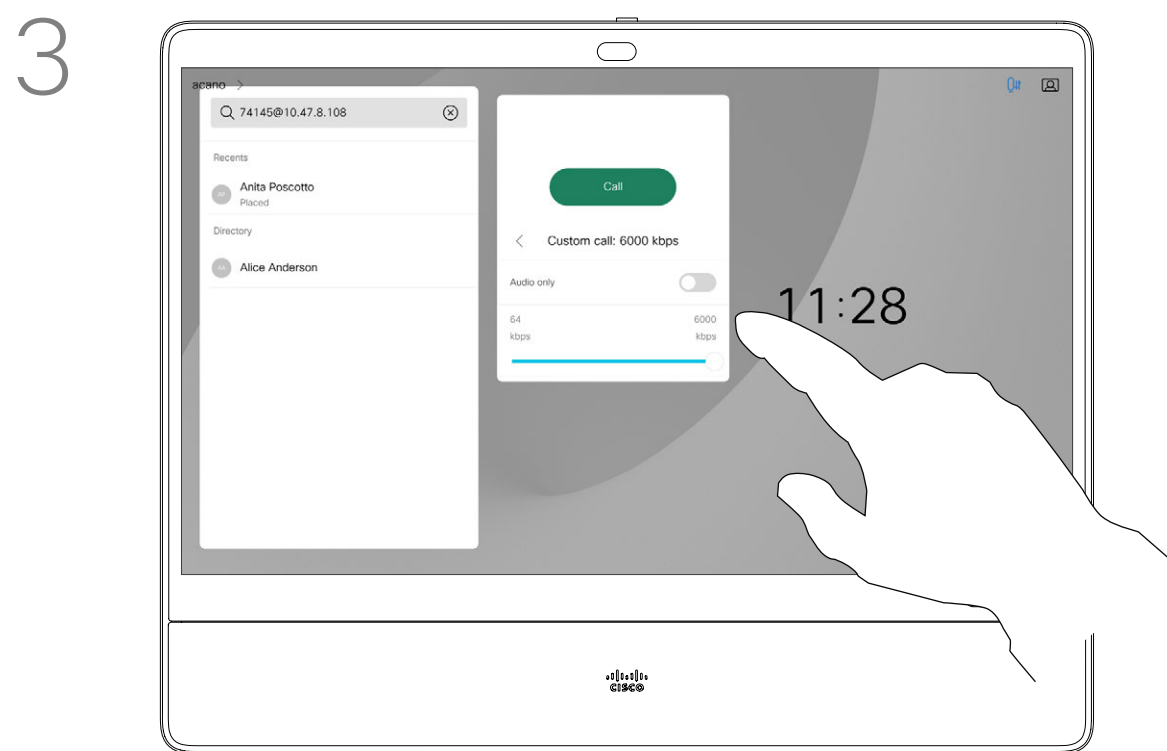

Move the slider to the required setting.

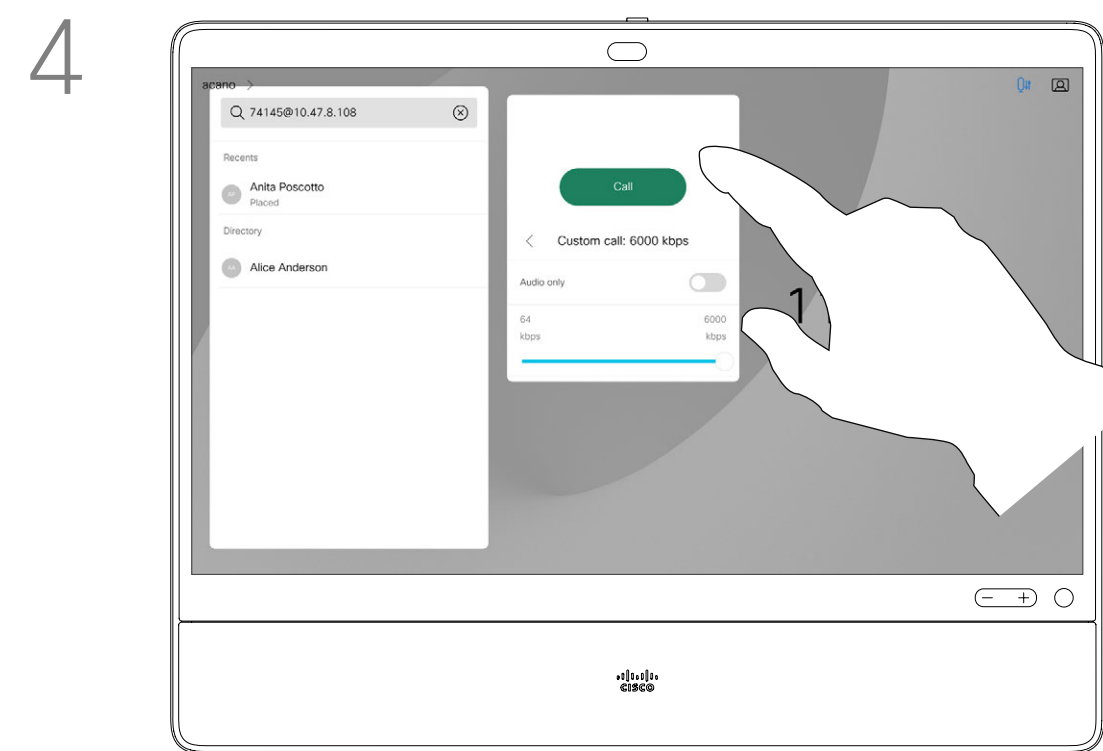

Tap the green **Call** button to place the call.

About call rate

Call rate is the term used to express the amount of bandwidth allocated to the call. It is measured in kbps (kilobits per second).

The higher the call rate is, the better the quality is, but on the expense of higher bandwidth consumption.

The device comes with a default call rate. This is normally set by your video support team. Under normal conditions the call rate is adjusted automatically by the device, whenever needed. This is done to avoid choking the video call when you try to call someone at a higher rate than their device and connection support.

If, for some reason, the automatic call rate setting fails, you may also do this manually as a last resort.

Call rate can't be changed during a call, but you may change it just before you place a call, as shown at left.

Activate do not disturb

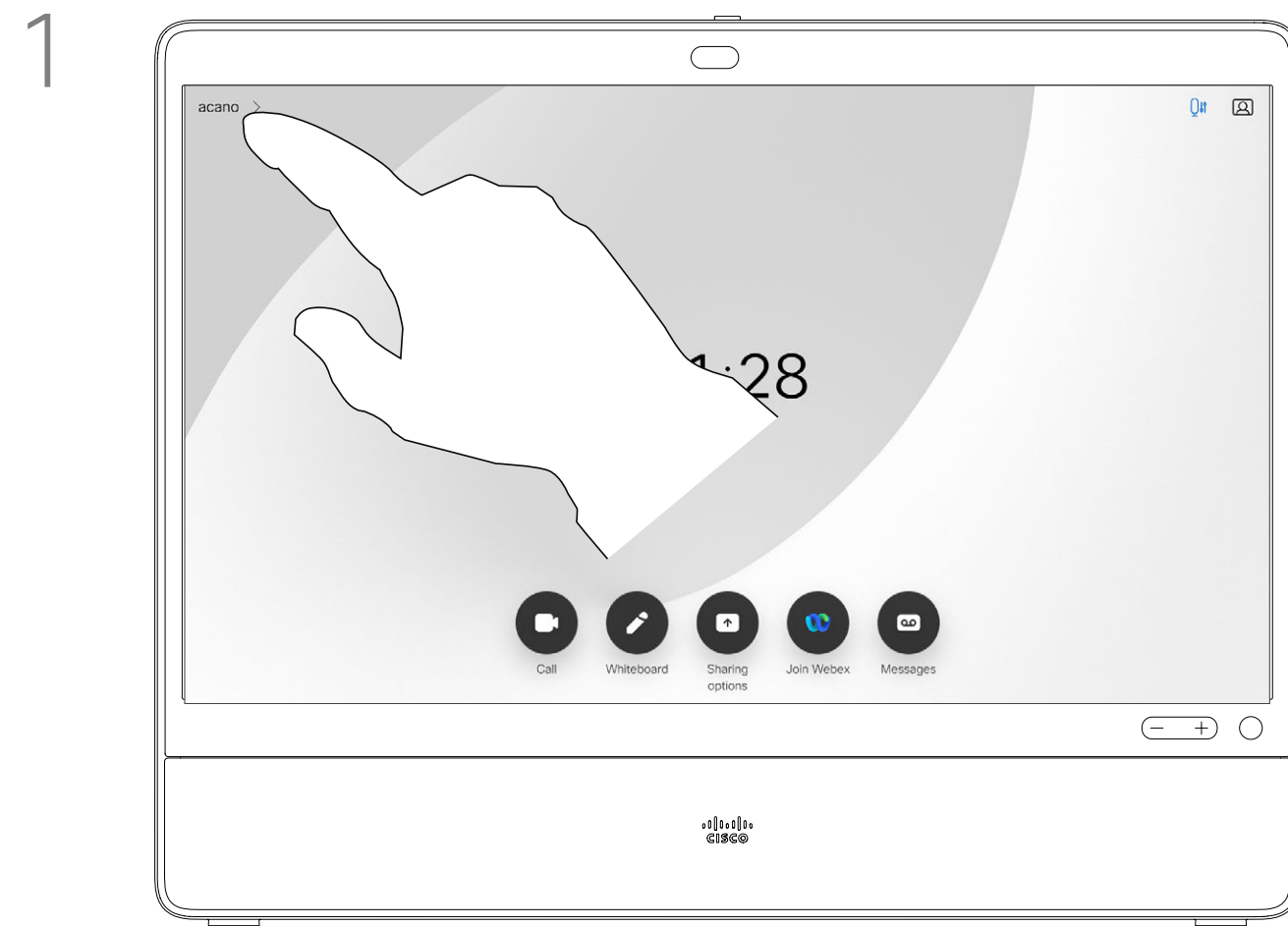

Tap in the upper left corner, as shown.

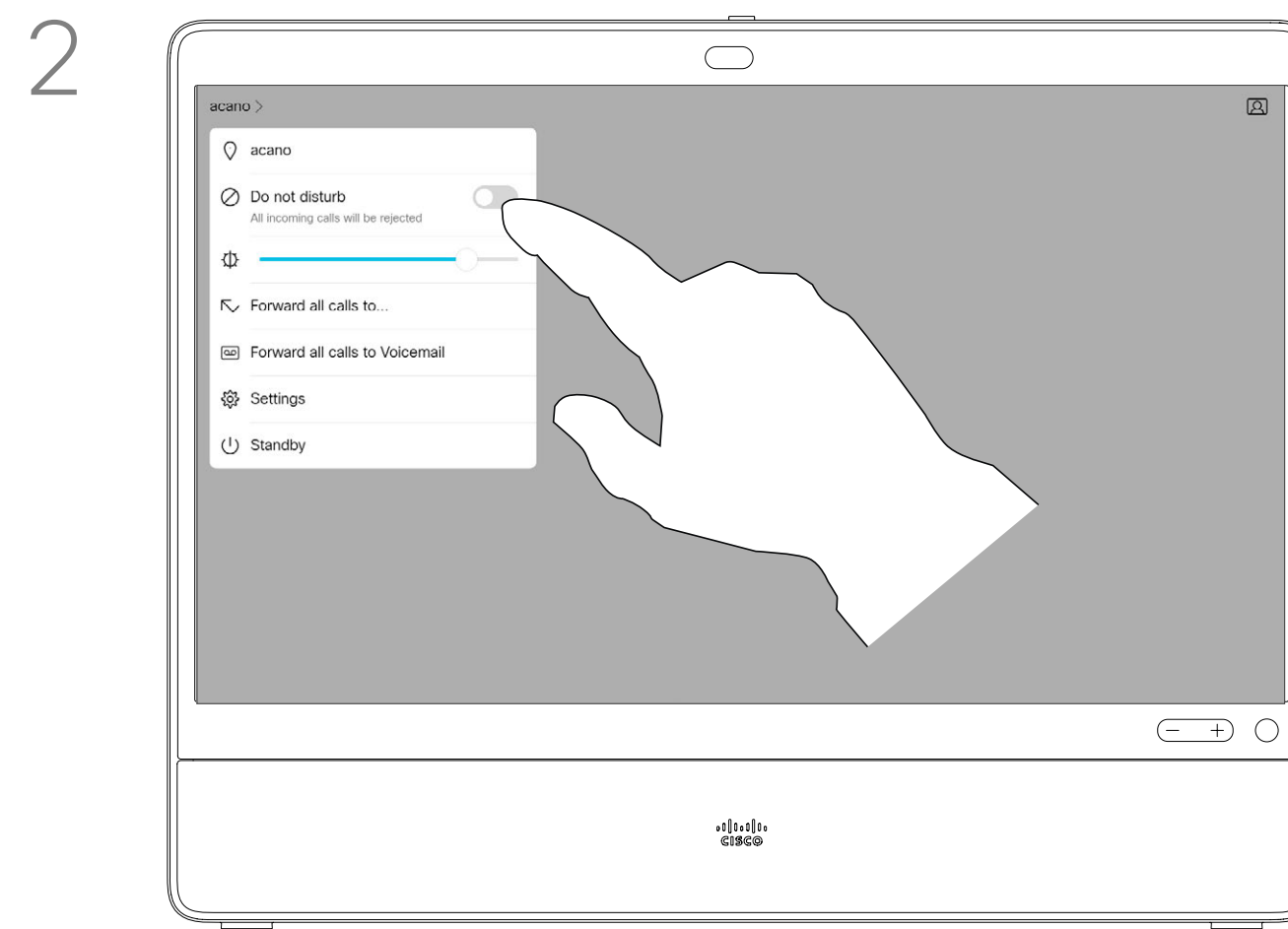

Tap **Do not disturb** to activate the feature. Tap again to deactivate.

About do not disturb

Your device can be set to not respond to incoming calls. You can still call others.

Your video support team may have set a time-out on this feature, after which the device responds to incoming calls as usual. Default time-out setting is 60 minutes.

Note that access to this feature may have been removed by your video support team.

Automated forwarding of all calls

About forwarding calls

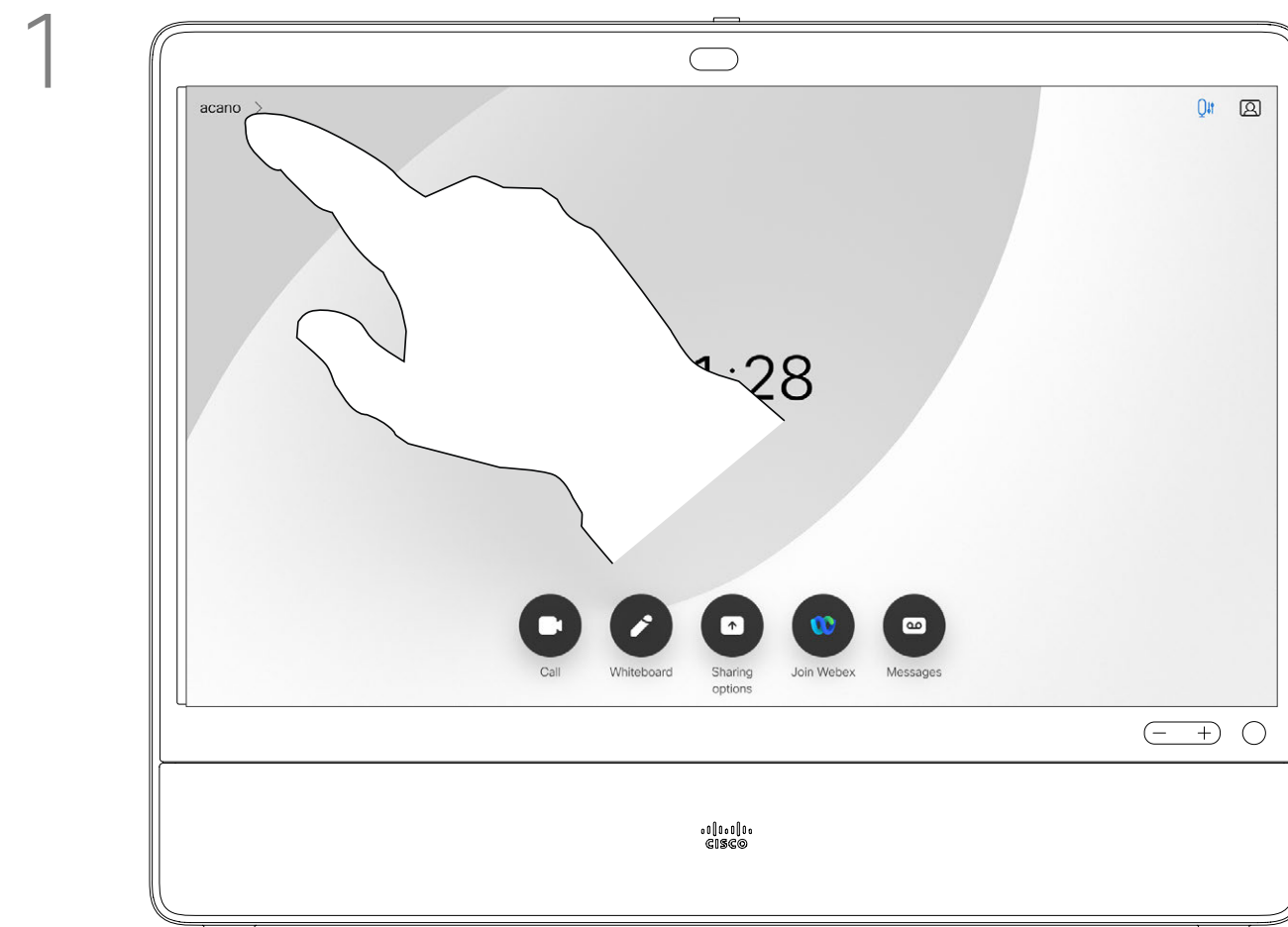

Tap in the upper left corner, as shown.

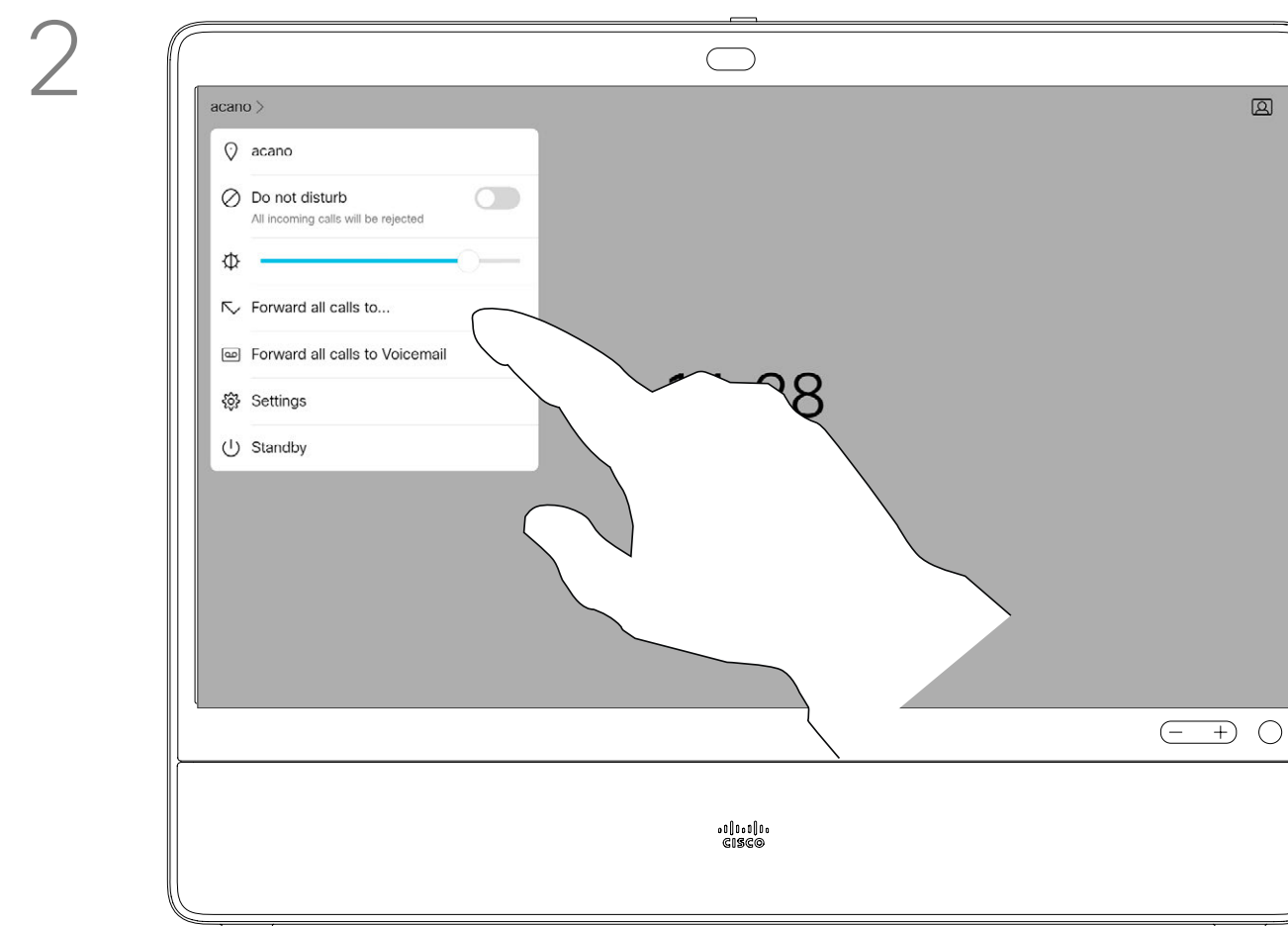

You may now choose to forward all calls to either a receiver specified by you, or to your voicemail.

Your video support team may have activated the option of forwarding all calls received. You may then choose between voicemail and a receiver appointed by you.

If you tap **Forward all calls**, the familiar **Call** menu appears letting you specify whom to receive your calls.

Note that access to this feature may have been removed by your video support team.

Video calls

View keypad while in a call

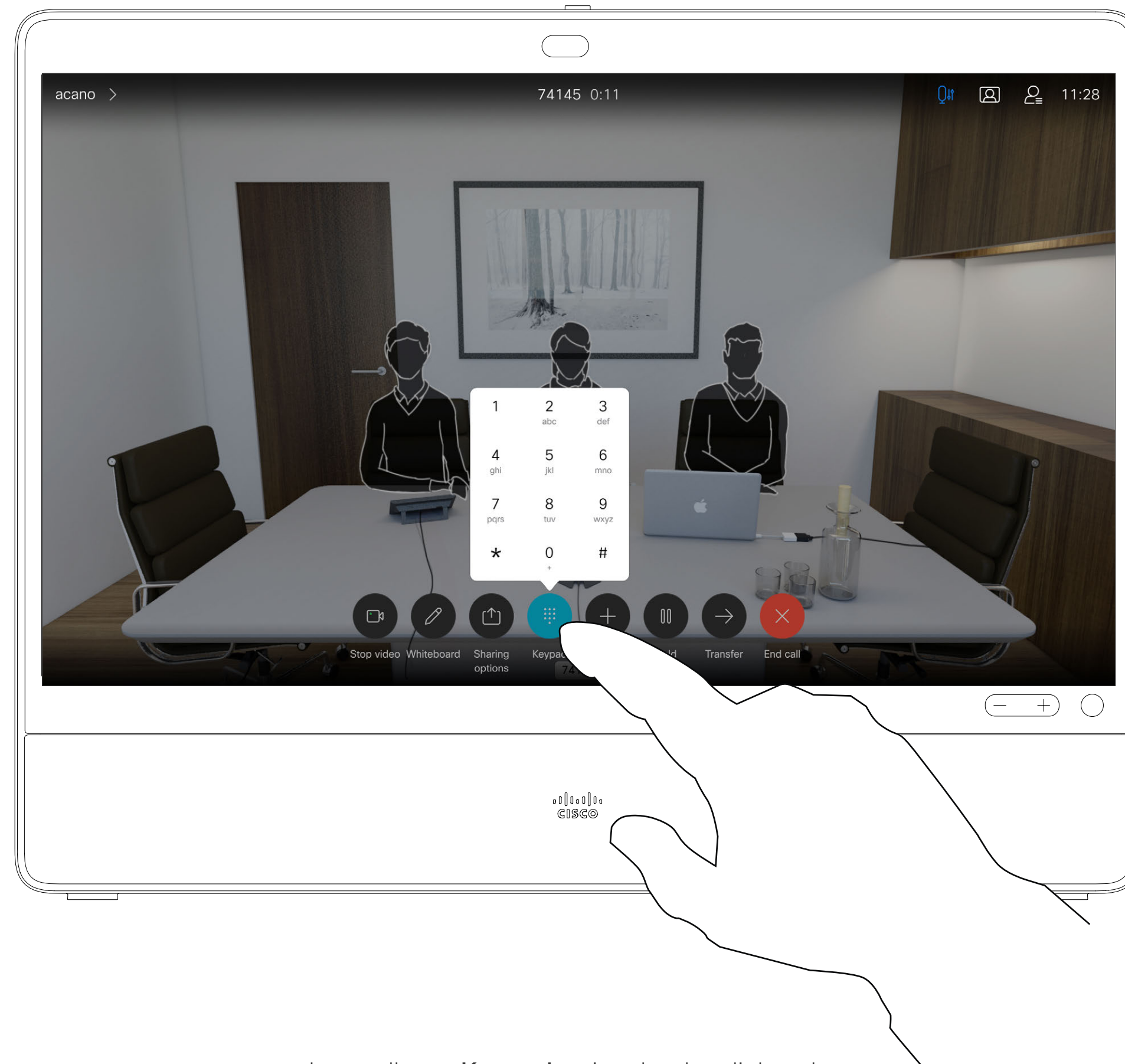

In a call, tap **Keypad** to invoke the dial pad.

Using keypad in a call

In a call you may get prompted to submit numbers to be able to reach an extension or otherwise gain entrance to something (for example by means of a PIN-code).

To enter the numbers, you need to invoke the keypad on the touch screen.

Add additional participants to an existing call

About video conferences

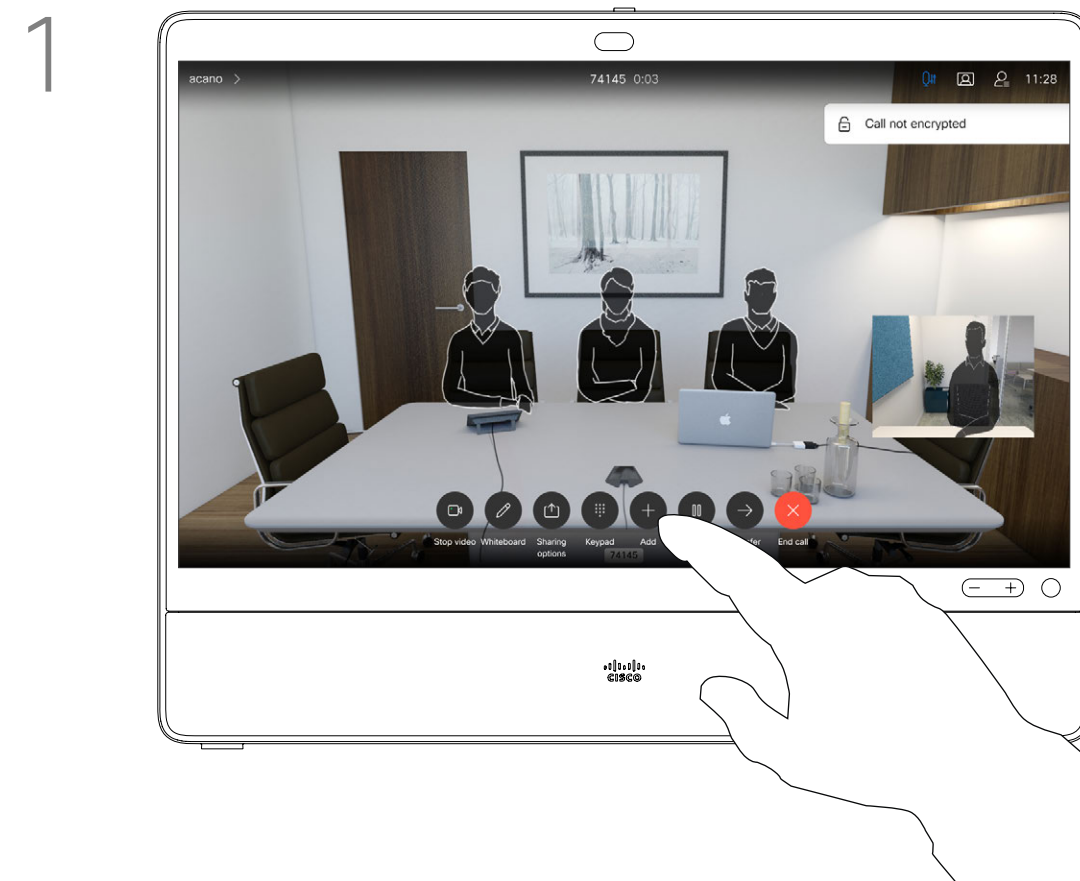

In a call tap **Add**.

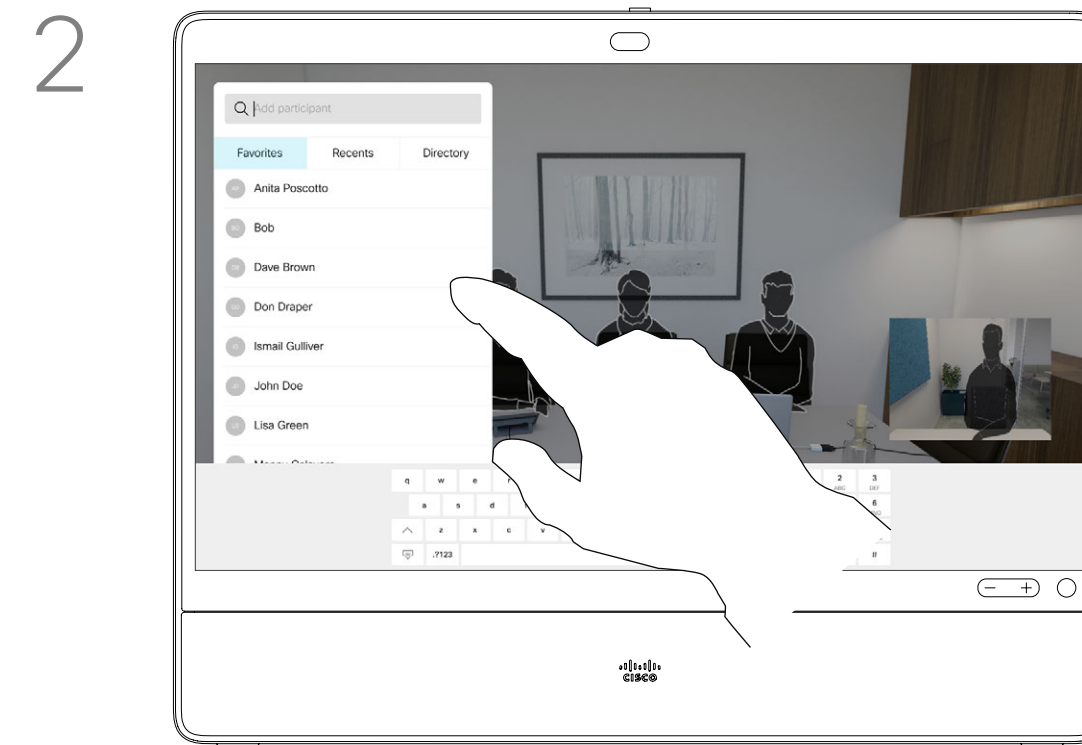

Locate whom to call, in the usual way.

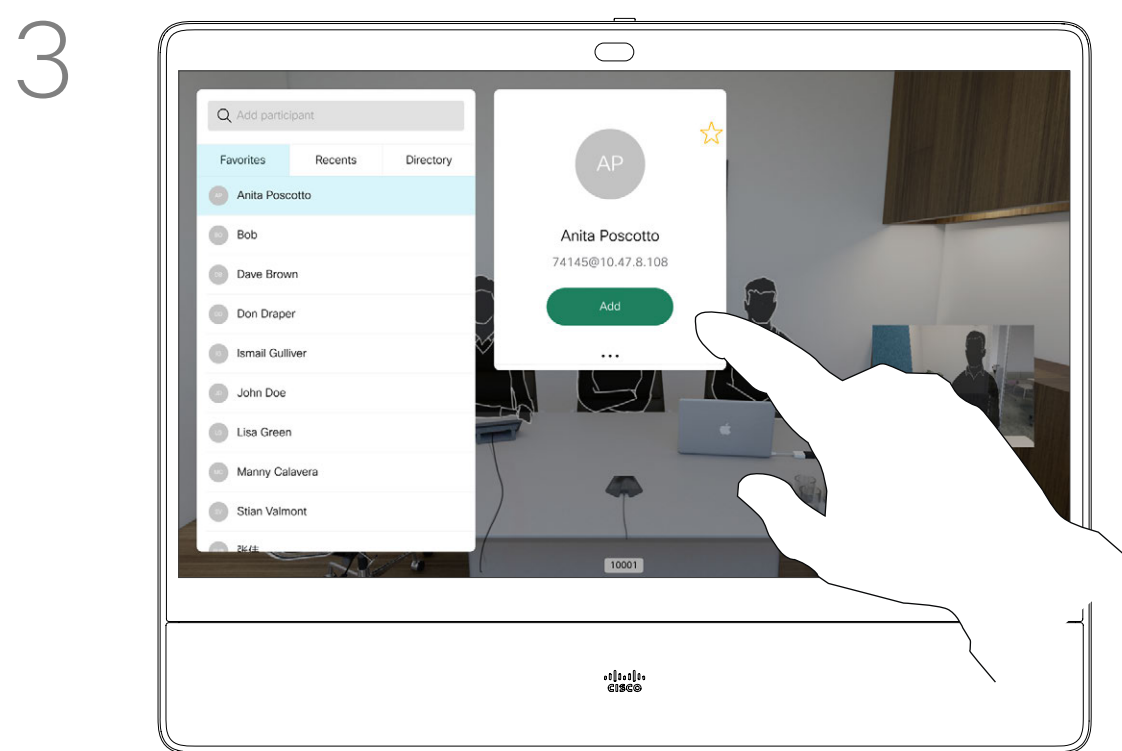

Place the call, in the usual way. You may alter the Call settings of that call before you place it—see side bar for more.



This new call is added to the existing and you have now established a conference.

You may repeat this procedure to the extent permitted by your video infrastructure.

Your network may be equipped with the capability to initiate a video conference with several participants.

The maximum number of participants supported by your device depends on device configuration and the video infrastructure. If in doubt, contact your video support team.

If you want to initiate a video conference, you must call each participant one by one.

If you are the one who initiated the conference you can terminate the entire conference. The other participants can only disconnect themselves from the conference.

Disconnect a participant from a conference

About video conferences

The ability to conduct a video conference from your desk device is an optional feature that may, or may not, be available for your device.

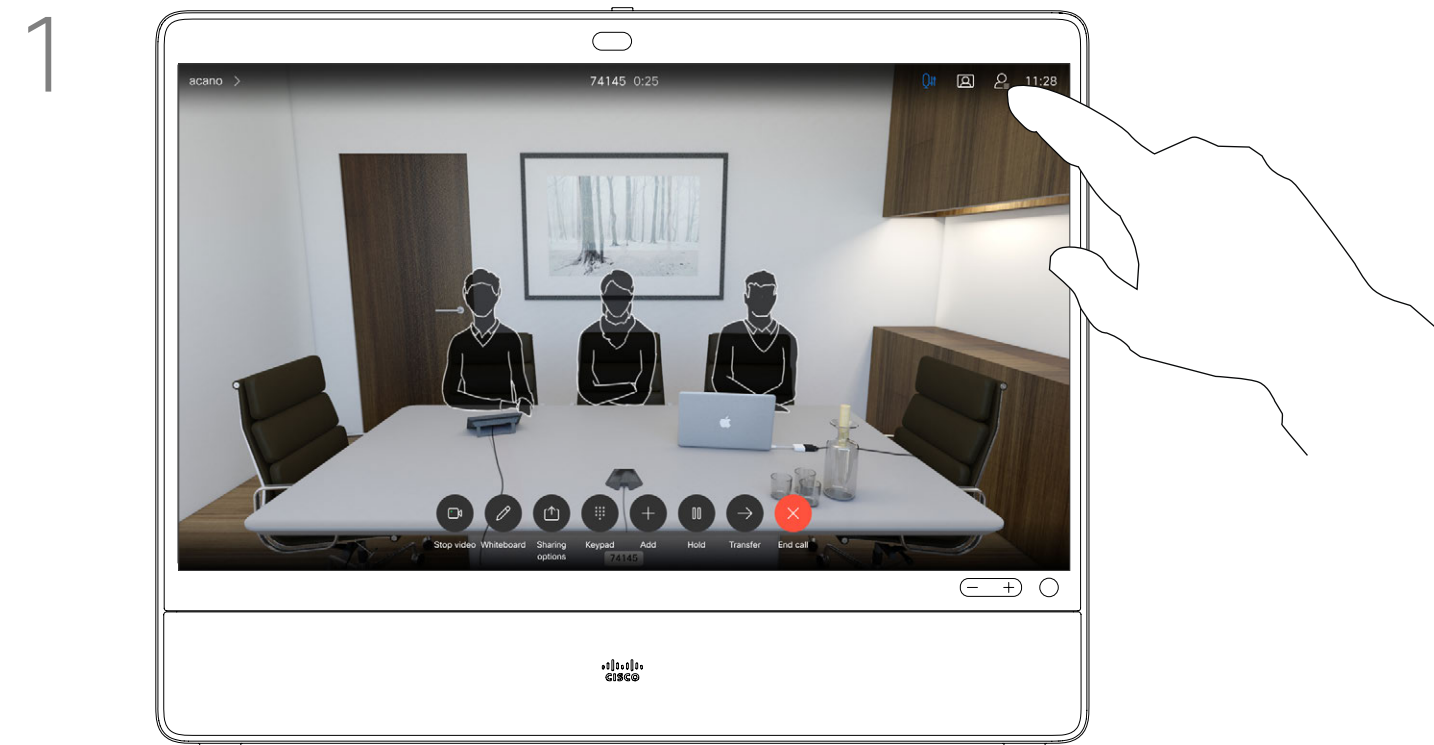

In a call, tap the **Participants** icon in the upper right corner, as shown, to invoke the list of participants.

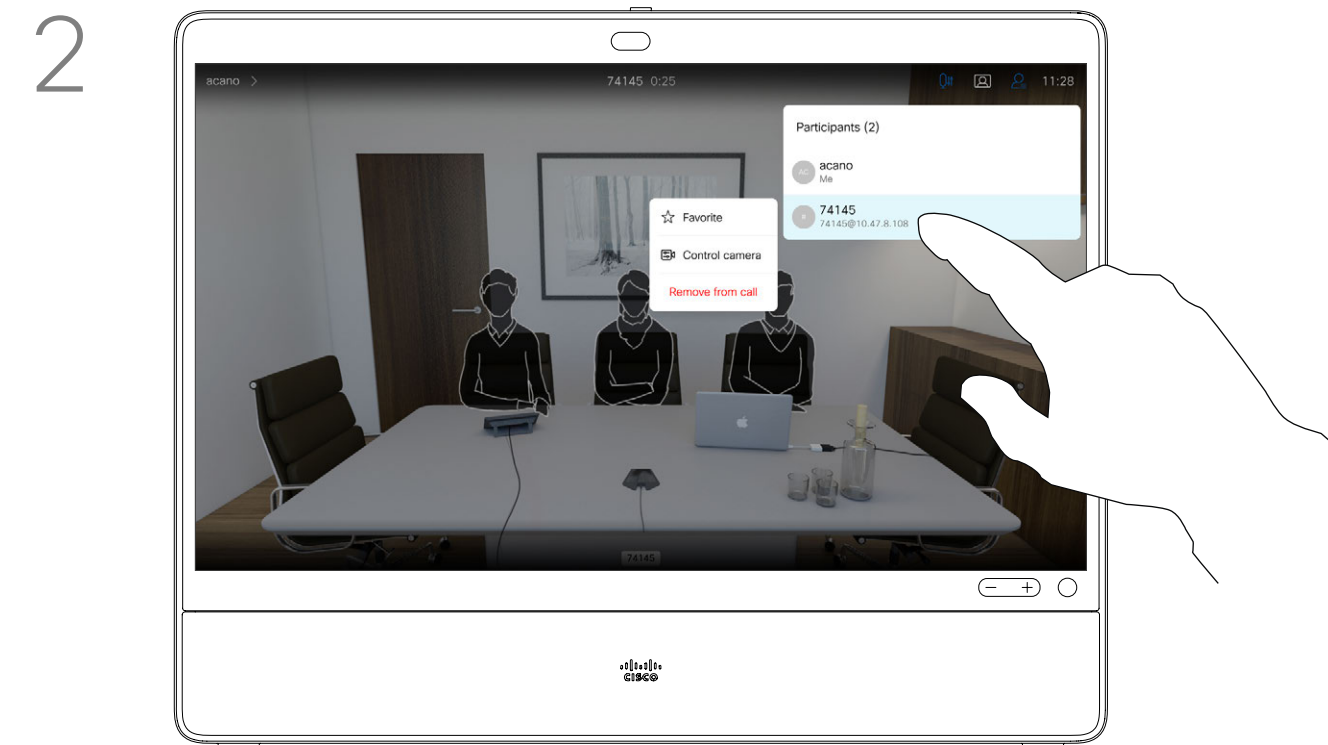

Tap the participant to be dropped from the conference.

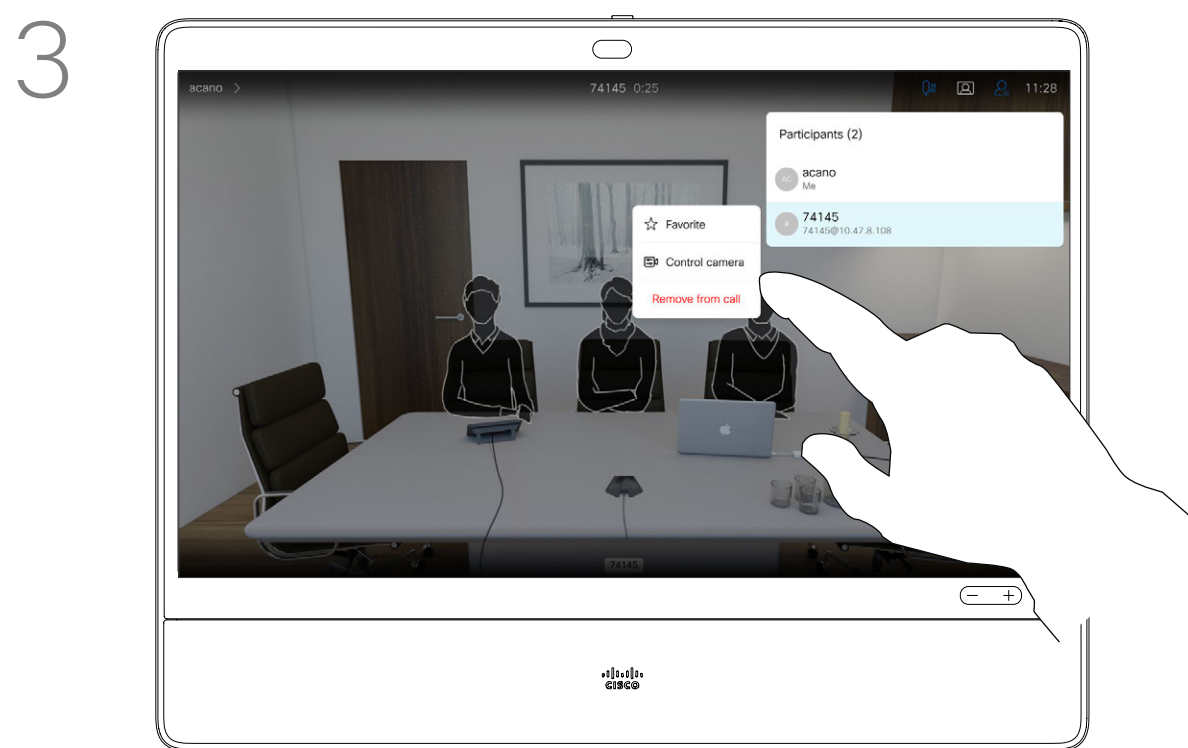

Tap **Remove from call**.

Admit a participant to a meeting

About admit participant

1

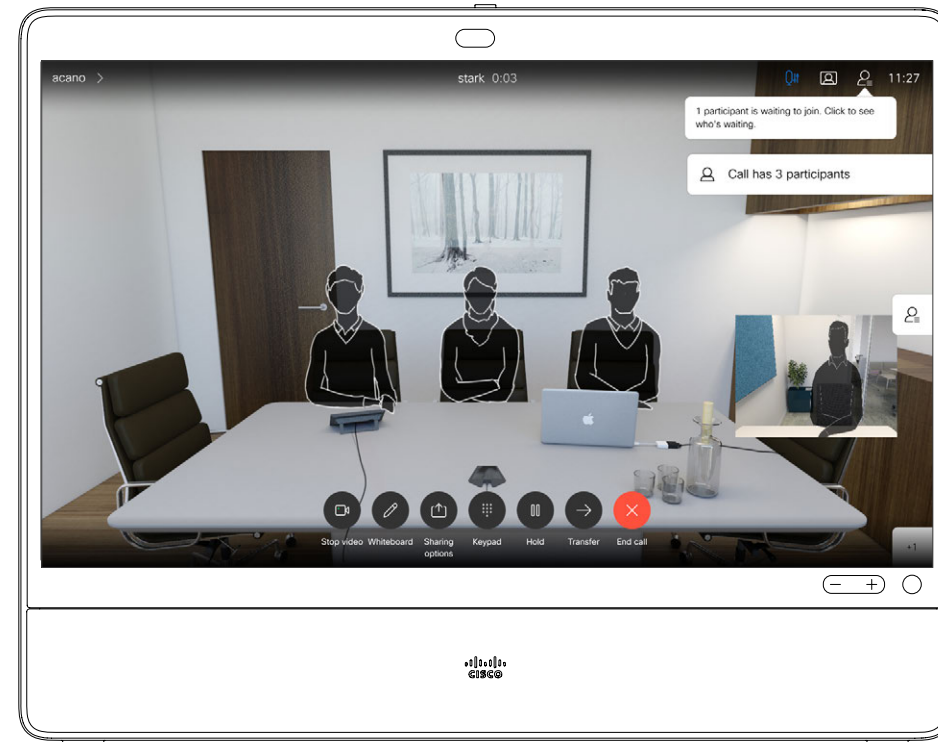

When someone is waiting in the lobby, you see an on-screen message.

2

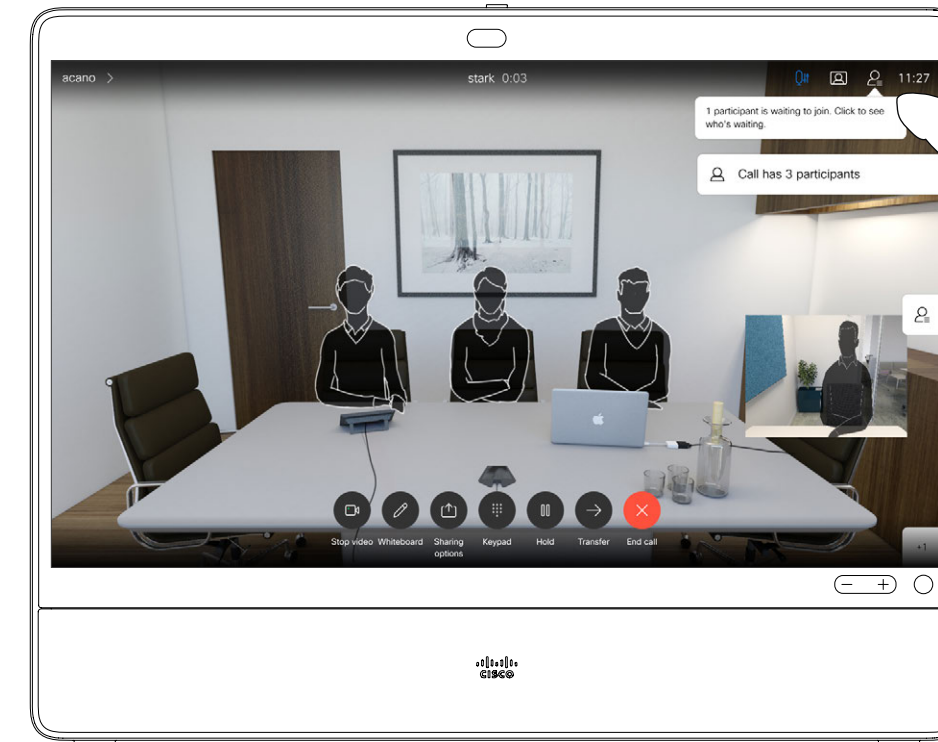

Tap the **Participant list** icon to open it.

3

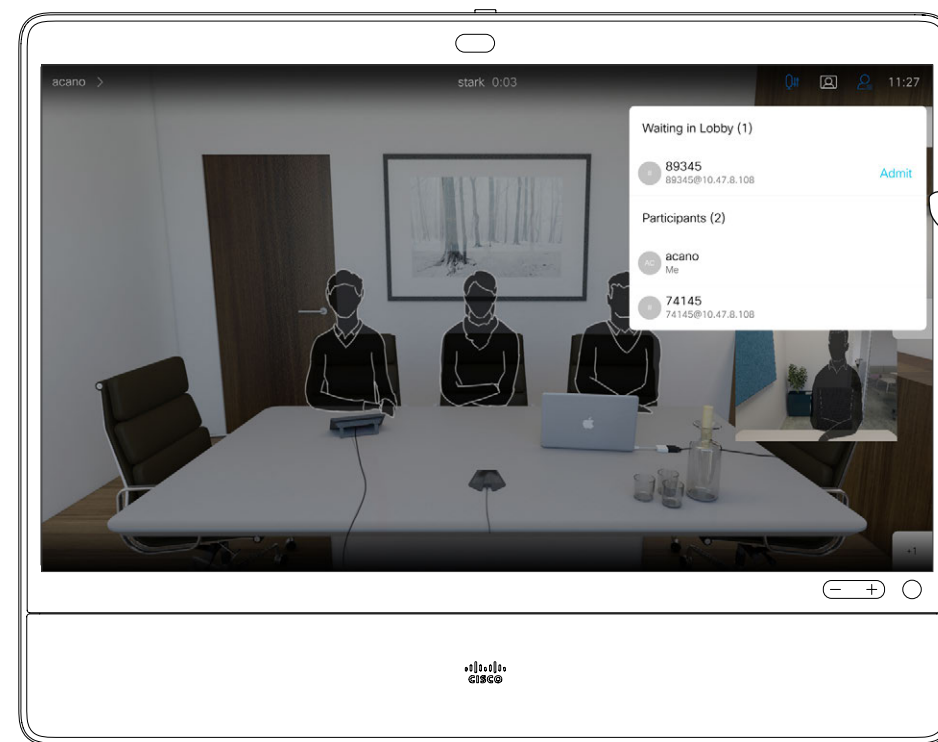

Tap **Admit** to let the participant in the meeting.

In a CMS meeting that is locked, you can let a participant join the meeting from the participant list.

Pin a speaker in a meeting

About pin a speaker

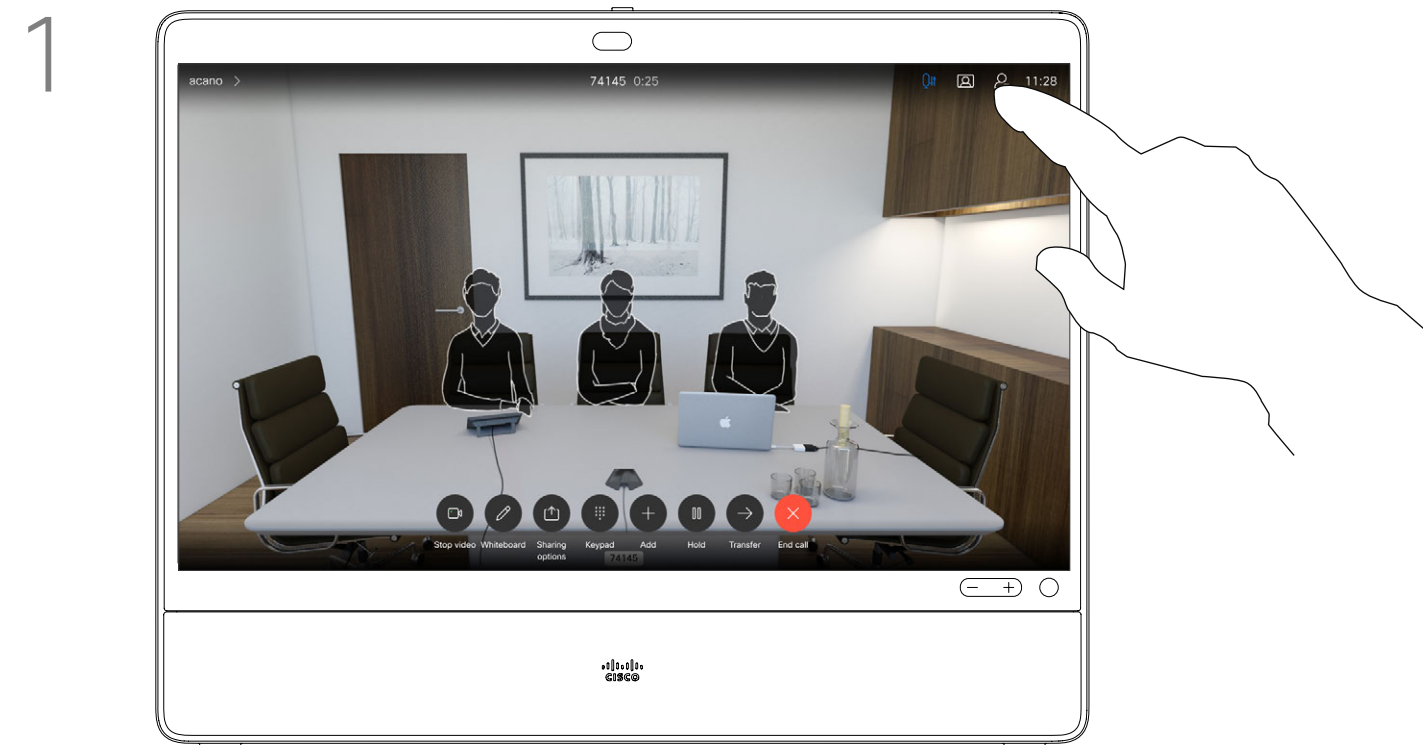

In a call, tap the **Participants** icon in the upper right corner, as shown, to invoke the list of participants.

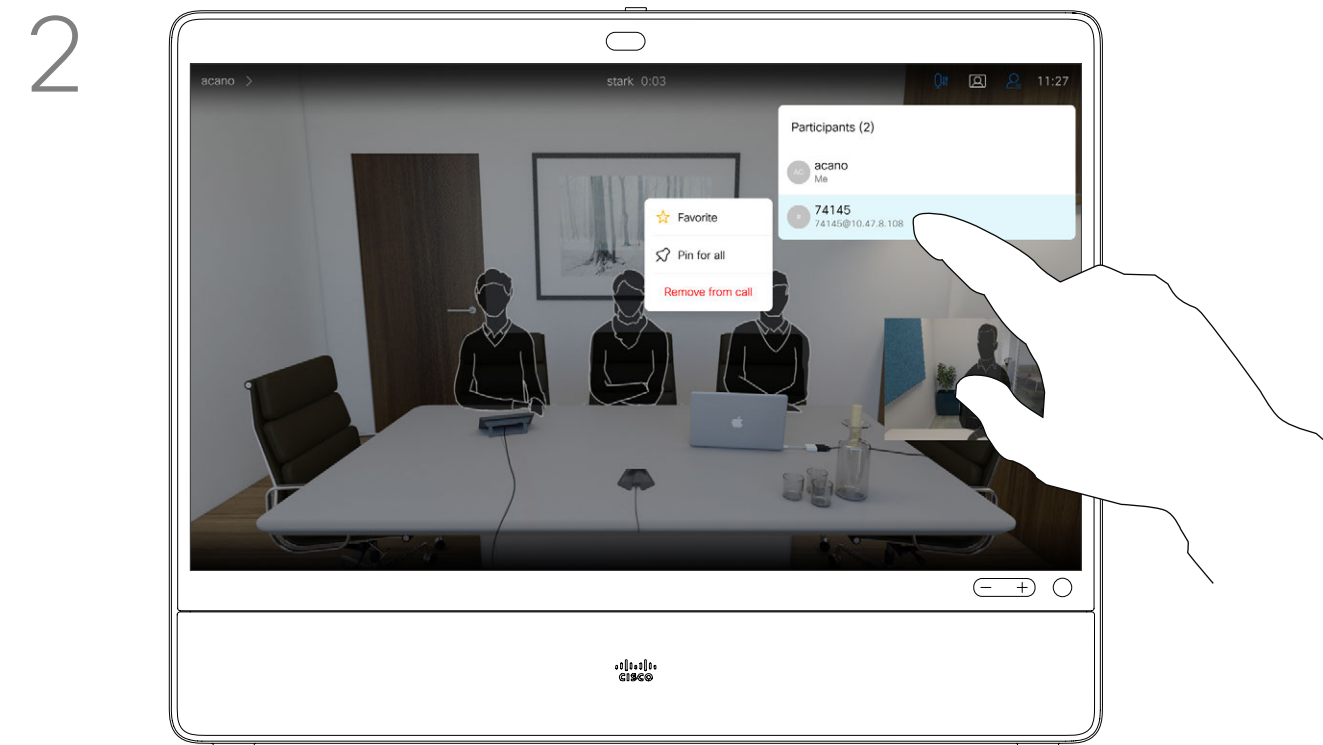

Tap the participant you want to pin.

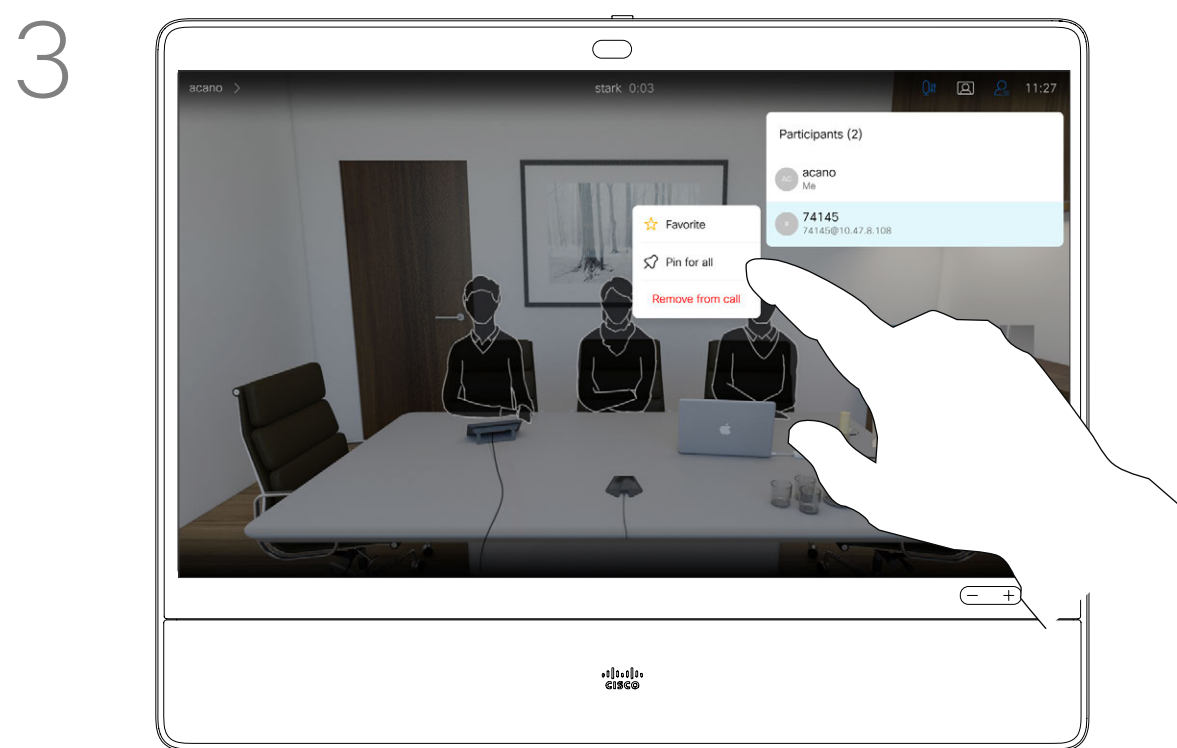

Tap **Pin for all**.

In a CMS meeting you can pin a meeting participant to show up as important for all the meeting participants. This way that participant or meeting room shows up on everyone's screens even when they are not the active speaker.

When you pin a speaker, a notification that they have been pinned shows up on their screen. Similarly, when you unpin them, they see a notification that they have been unpinned.

If you pin an audio-only participant, this will not affect the layout.

By default only the host can pin for all, but the meeting organizer can change this in the meeting settings.

You can pin a speaker for the whole meeting only in CMS meetings.

Video calls

Use Music mode

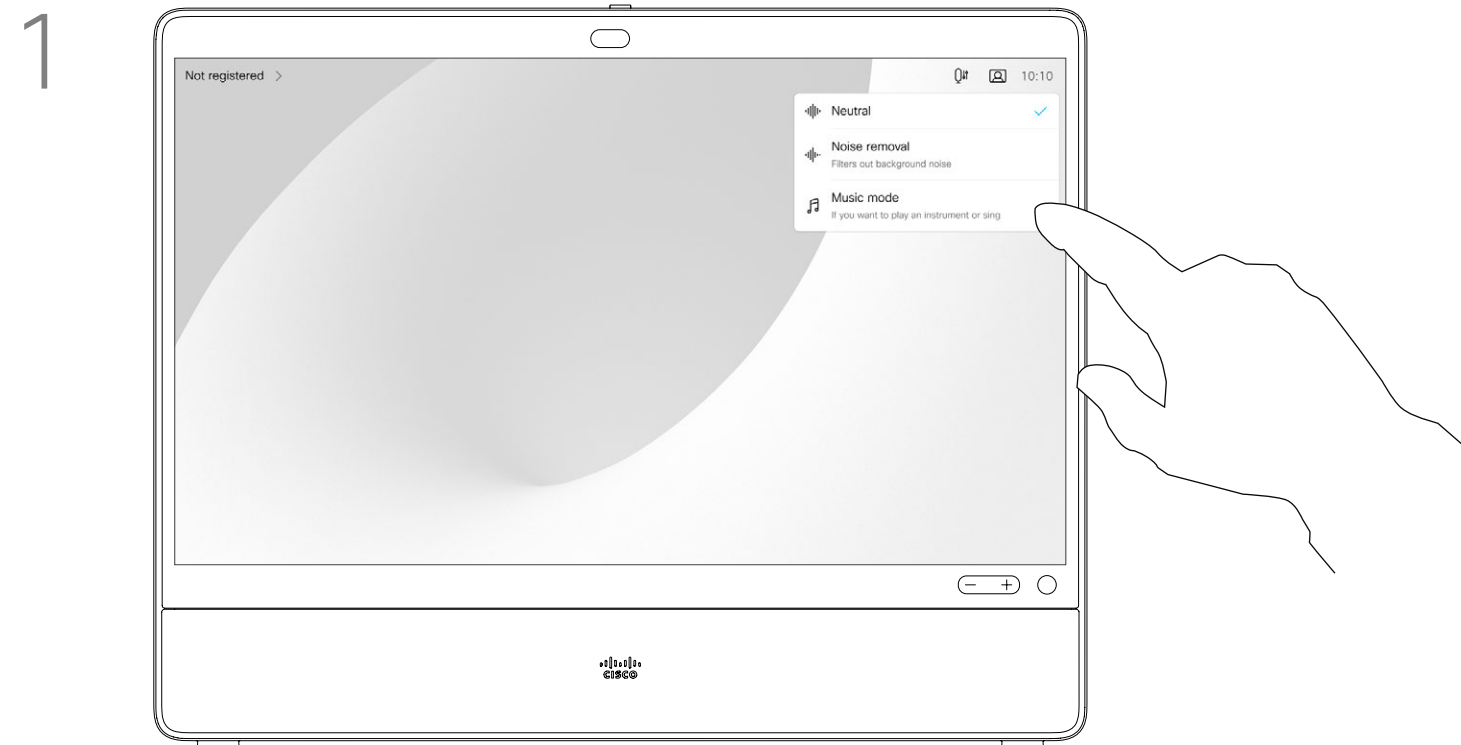

Tap the microphone icon of the home screen and select **Music mode**.

To turn off Music mode, select **Default** button again.

About Music mode

Using Music mode allows the dynamic range of music go through in a call. This creates a better experience in settings where it's important to hear the nuances in music.

Music mode is useful for remote music lessons, testing musical instruments, and other situations where it's important to hear the full range of music. The device still uses its echo cancellation and environmental background noise reduction capabilities to avoid the need for external equipment, without detracting from the performance.

When Music mode isn't in use, the device filters out additional noises and reduces sound level variations. This caters for meeting settings and helps reduce distracting noise. The additional filtering also works well when you play recorded music through the device.

To use Music mode, you need to enable it on your device first. Select the device name in the upper left corner of the home screen and go to **Settings > Music mode** and toggle it on.

NOTE: Music mode and Noise removal can't be used at the same time.

Raise hand in a meeting

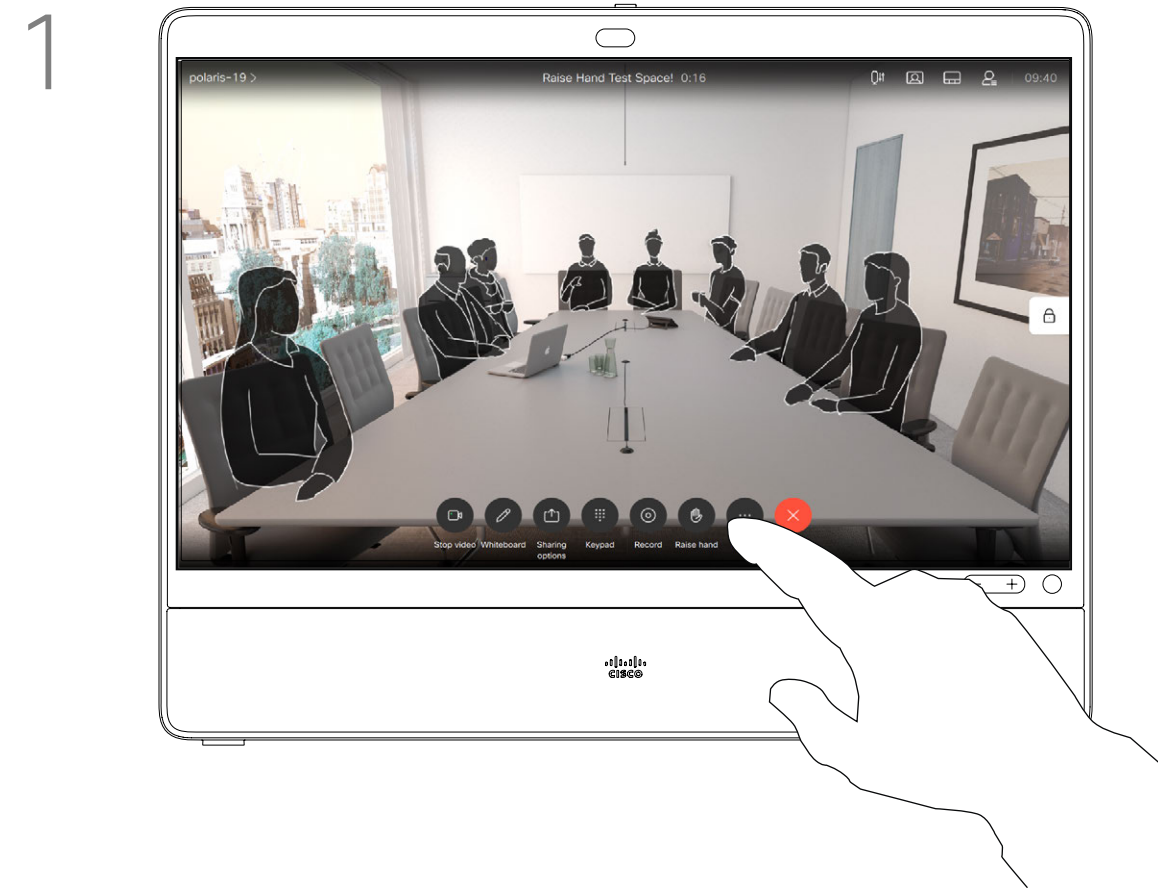

In a meeting, tap the **Raise hand** button.

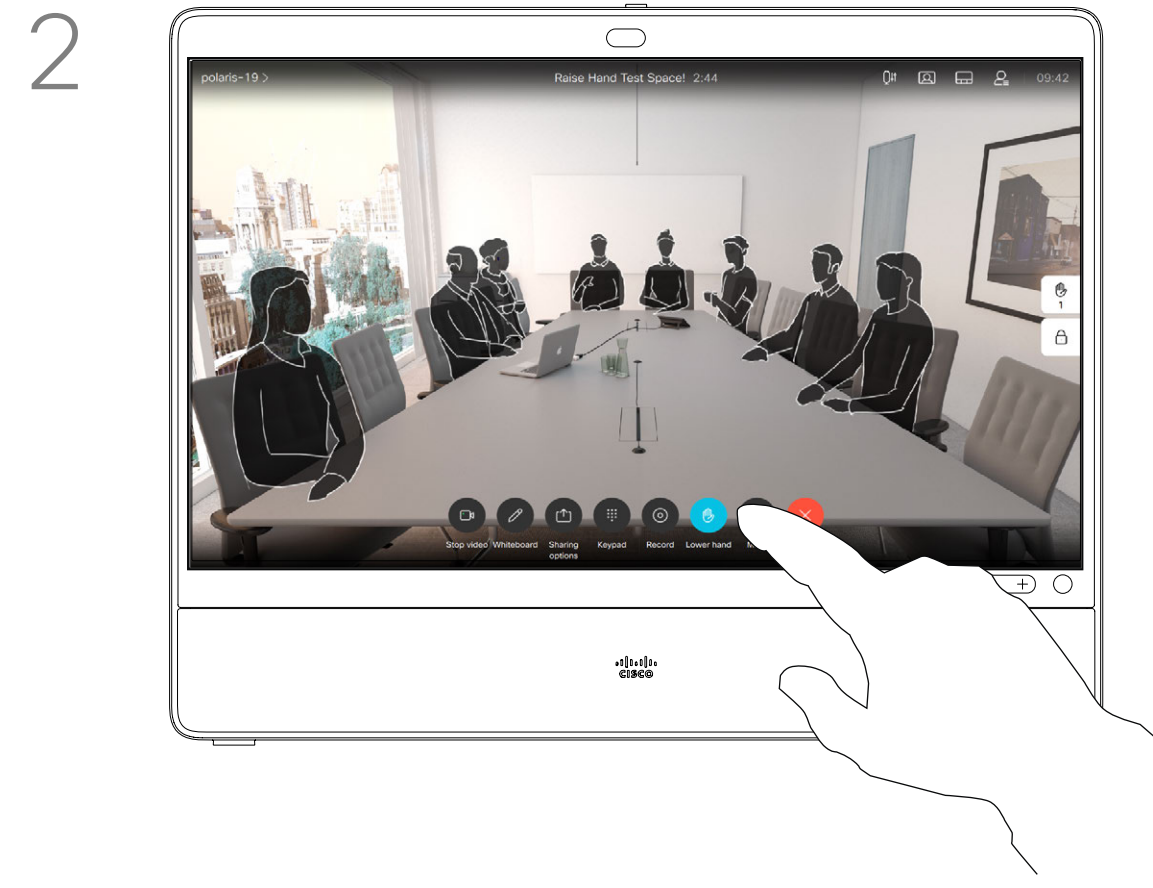

Select the **Lower hand** button to lower your hand. This also removes the icon from the participant list next to your name.

About raise hand

Use the Raise Hand button to let others know you have a question or a comment without interrupting the conversation.

Both the host and others in the meeting see an on-screen notification that someone has raised their hand. The notification with a full name shows up for the first raised hand.

After that, the Raise Hand icon shows how many have raised their hands.

You can tap the Raise Hand icon to open the participant list to see who has raised their hand.

Raise Hand is available in meetings with more than two participants.

Raise hand is available in CMS meetings.

Use gestures in a meeting

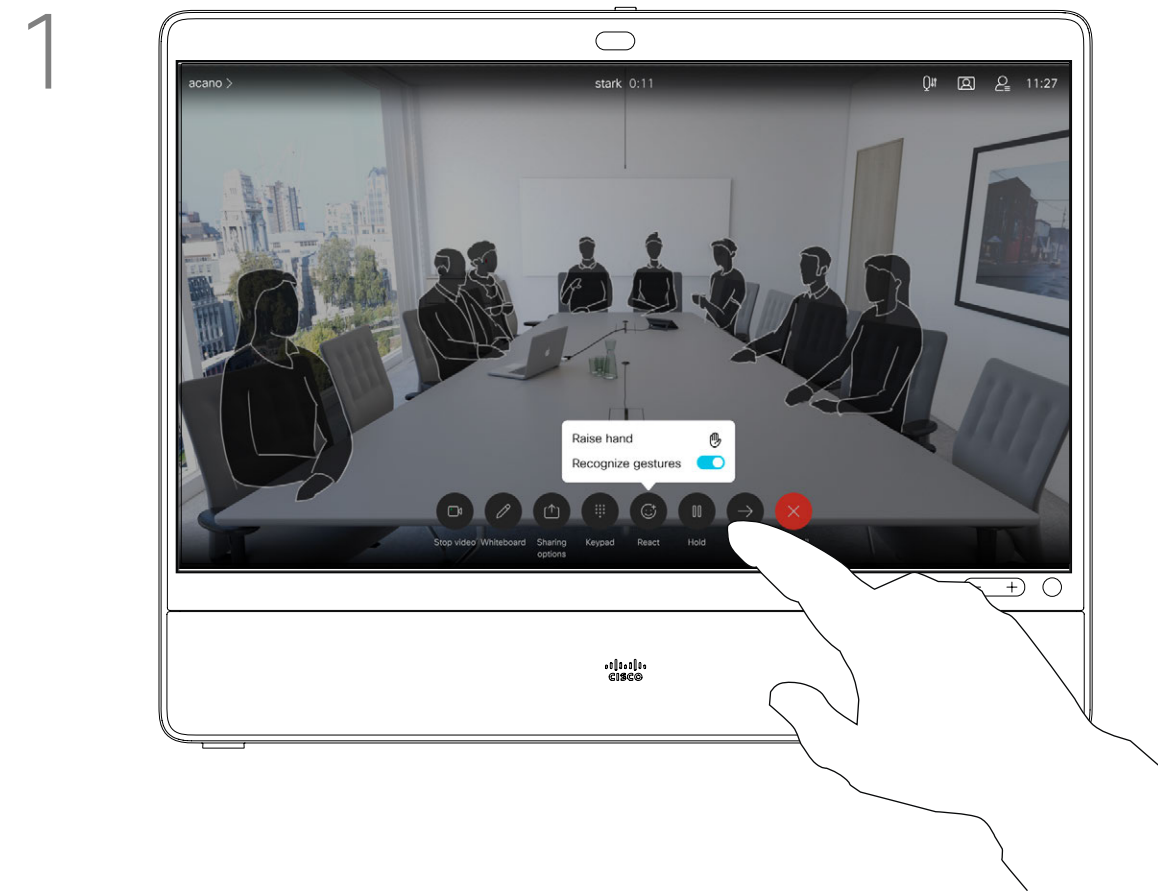

In a meeting, tap **React** and toggle on **Recognize gestures**.



Raise your hand, or give a thumbs up or down in front of your device. A confirmation timer appears on screen.

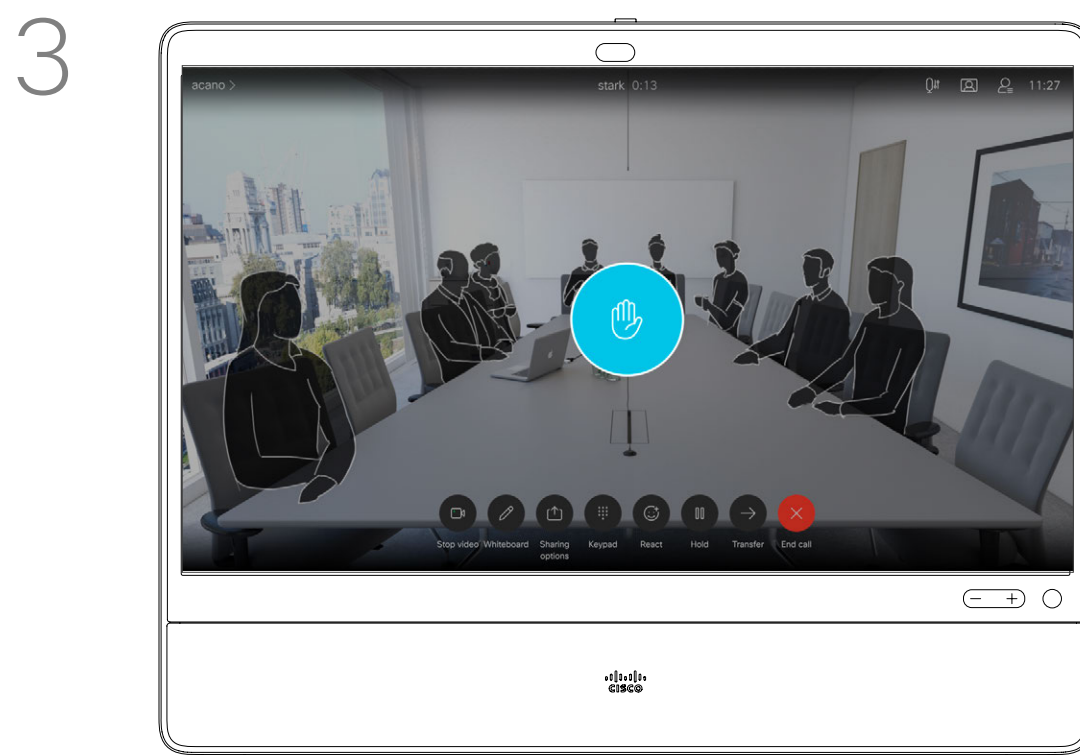

Hold your reaction until the timer is complete. If you stop your gesture before the timer is complete, no action is triggered.

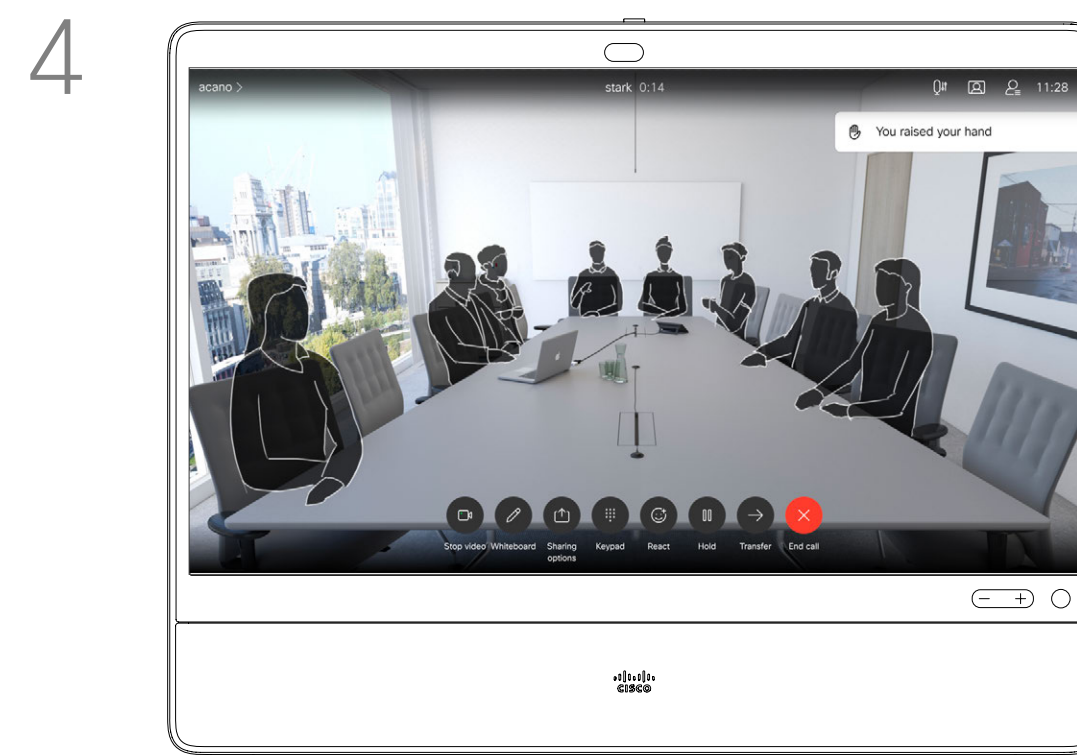

The meeting participants see an on-screen notification that someone has raised their hand.

The meeting participants see a thumbs up or down on screen.

To lower your hand, tap the **React** button again and select **Lower your hand**.

About gestures

Raise your hand, or give a thumbs up or down in front of your device to let others know you have a question or react, without interrupting the conversation.

Gesture Recognition is off by default. You can turn it on by going to the Settings menu. Then, select Gesture control and toggle on Enable hand gesture recognition. You can also turn it on during a meeting by tapping the React button in the call control and toggle on Recognize gestures.

Gestures are available in CMS meetings.

Find call details for recent calls



Locate the entry to be edited before a call is placed. Tap that entry. This opens the *Call* menu.

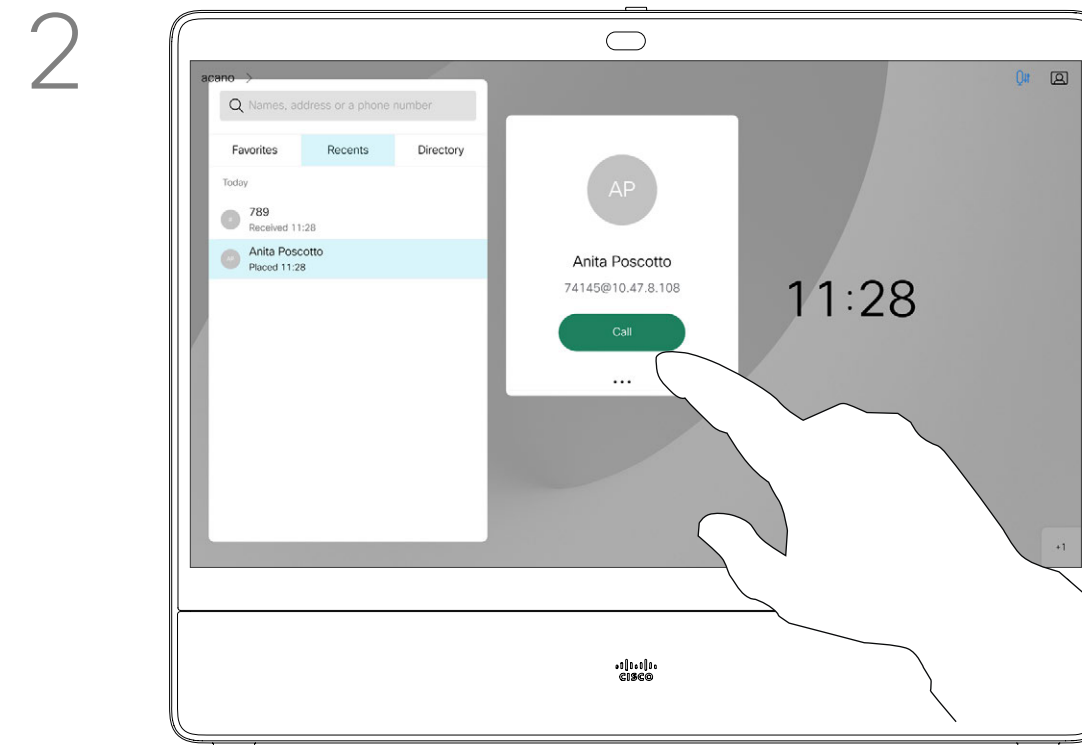

Tap the **More (...)** icon just below the green **Call** button.

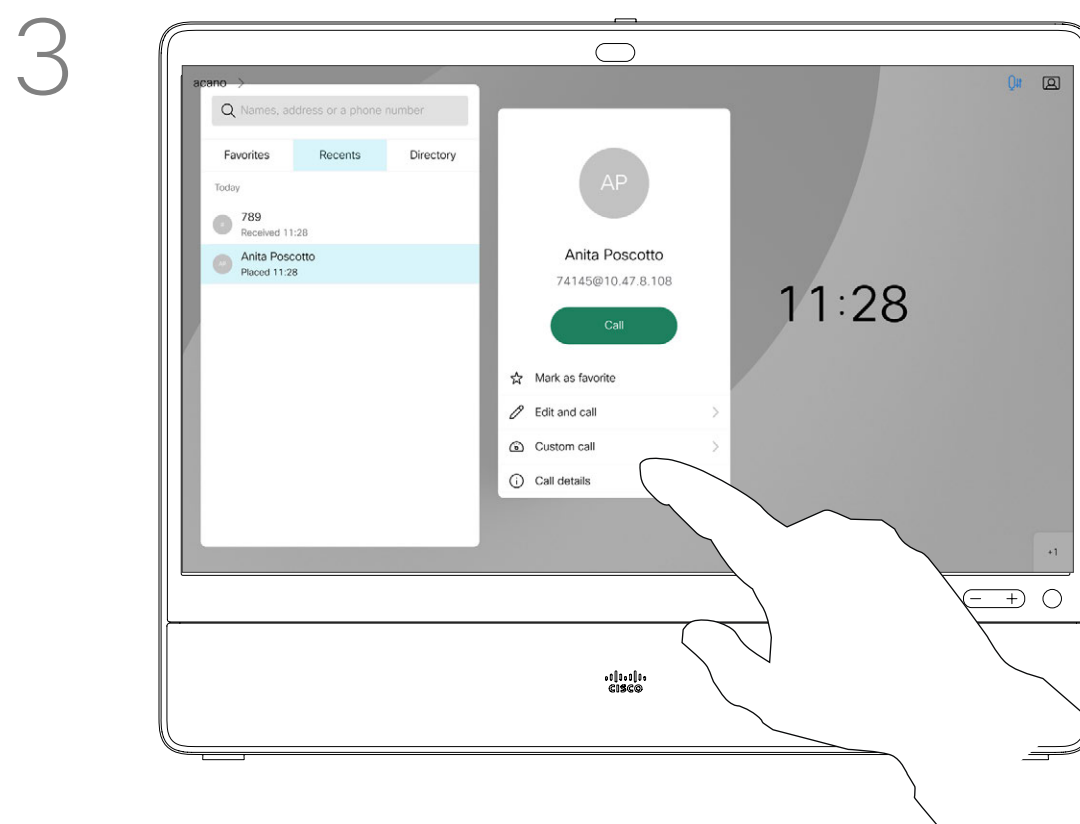

Tap **Call details**.

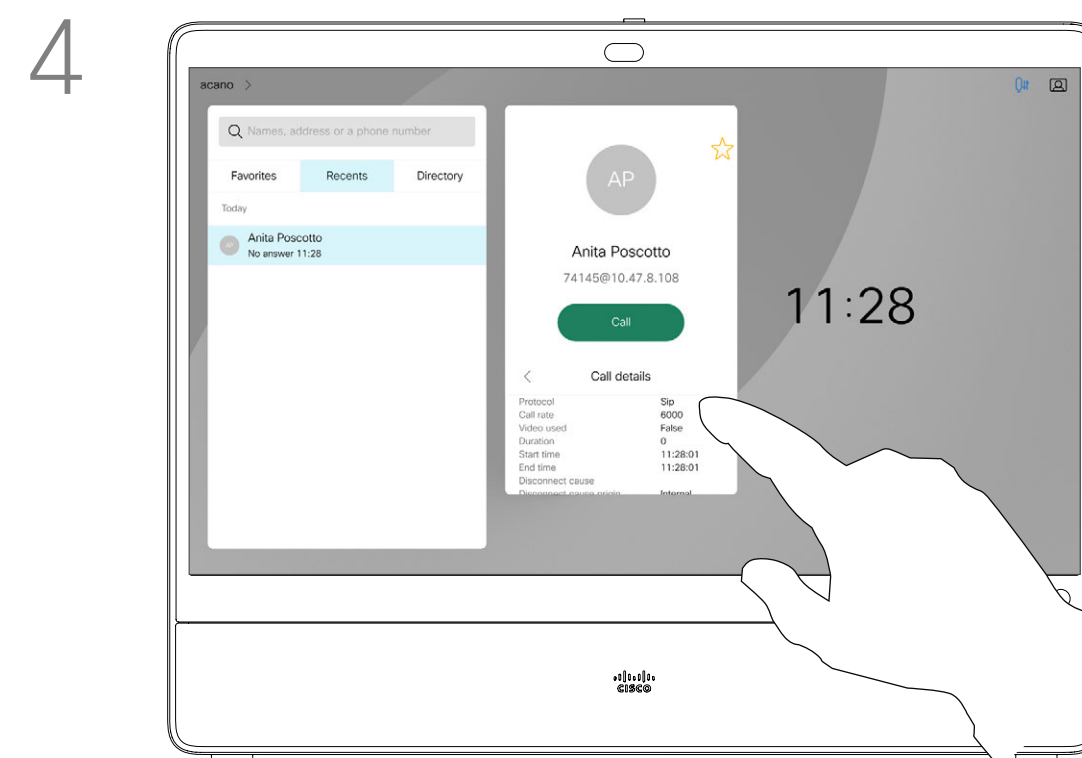

Scroll down the list to see the call details.

If you need to troubleshoot a recent call, you can find the call details from the recent calls list.

Intelligent Proximity



Cisco Proximity ultrasound signal

Cisco devices emit ultrasound as part of the Proximity feature. Most people are exposed to ultrasound more or less daily in many environments, including industry, commercial applications, and home appliances.

Even if airborne ultrasound may cause subjective effects for some individuals, it is very unlikely that any effects occur for sound pressure levels below 75dB. Guidelines for ultrasound exposure limits vary heavily between countries, but 75dB is the lowest limit presently found for the frequency band around 20kHz, which is where the Cisco proximity signal is emitted.

A good reference for this information is Health Canada's guidelines, http://www.hc-sc.gc.ca/ewh-semt/pubs/radiation/safety-code_24-securite/index-eng.php#a2.2.2.

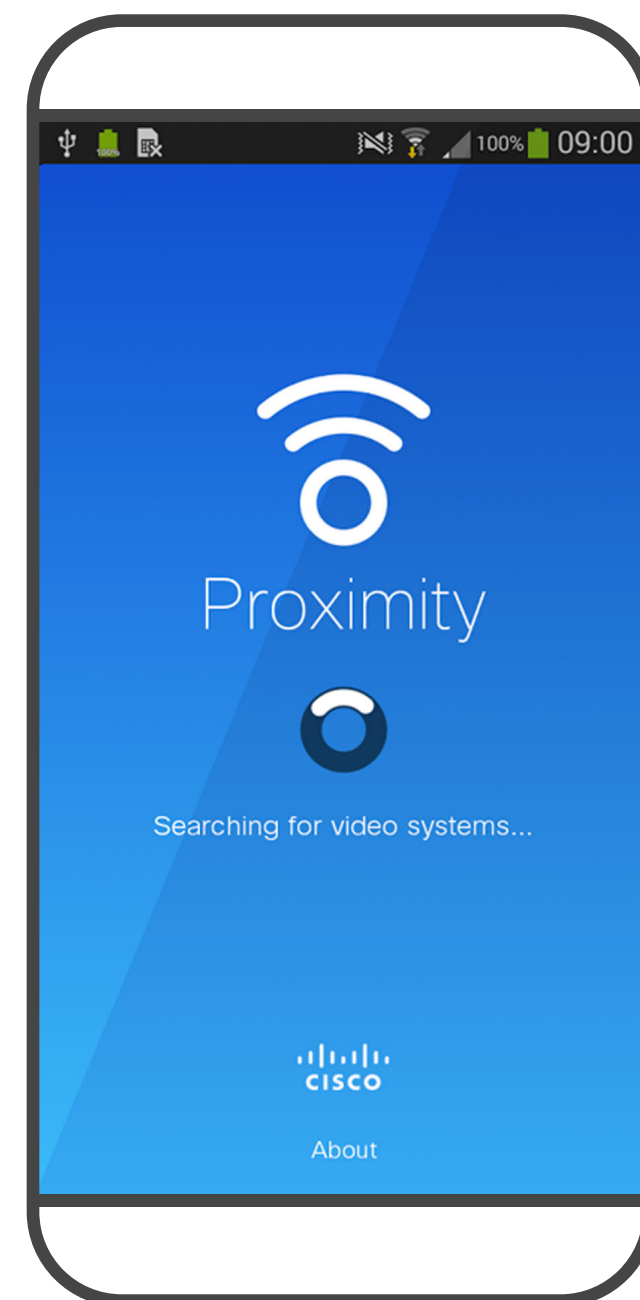

These guidelines state that sound pressure levels lower than 120dB have not been demonstrated to cause hearing loss, neither permanently nor temporarily.

For Cisco devices for personal use the ultrasound sound pressure level is below 70dB at a distance of 20 cm or more from the loudspeaker.

In most practical cases the level at the ear of the user will be much lower than these max levels, due to loudspeaker directivity, distance attenuation, and high degree of high frequency absorption in typical rooms. The levels will range from what for audible sound would be typical background / ambient noise levels in meeting spaces up to so-called conversational levels of normal speech.

It is therefore deemed safe for humans to be continuously subjected to the proximity signal. Most people will not be aware of the presence of the signal, and suffer no effects from it. A few individuals with especially acute high frequency hearing can, however, be able to hear it, this is most likely to happen directly in front of and close to the loudspeaker.

It is obvious that animals like dogs will hear the proximity signal, since their frequency range of hearing is so much wider.

However, the effect of sound is also level dependent, and the level range of a dog's hearing is not significantly different from that of a human. The hearing threshold of dogs at 20kHz can be as low as 0-10dB, similar to the threshold of a human ear in its most sensitive frequency range.

Cisco has not done testing or qualification of the possible effects the signal can have on dogs. Due to the limited levels it is believed that while the signal is clearly audible, it is not bothersome to dogs.

A dog in an office or meeting room will be subject to ultrasound at levels comparable to normal background noise, or at most conversational levels. There has been no reports of animals

being bothered by the signals in the years we have had this feature in our products.

However, the question of ultrasound effect on dogs is fair, since dog repeller devices using ultrasound do exist. These devices typically claim to use discomforting, but not harmful ultrasound. Cisco does not have insight into dog repeller design, but scanning the specifications of such devices typically reveals that the exposure levels typically are 100dB and upwards.

For solutions using Cisco video codecs with 3rd party loudspeaker systems Cisco is not able to control the ultrasound sound pressure level. In most cases the necessary loudspeaker sensitivity and frequency response will result in levels below the 75dB limit. However, if excessive external amplification is applied, or the loudspeaker system has an emphasized high-frequency response, levels in excess of the limit can be produced.

About Proximity

The Intelligent Proximity feature allows you to share content from a computer wirelessly on the device.

You can even use your own smart phone, tablets, PC or MAC to control calls on the device.

Observe the following:

You can download the Cisco Intelligent Proximity app from App Store or Google Play (free of charge).

Windows or OS X users, go to <https://proximity.cisco.com/>.

Your video support team may have activated none of the features, all of them, or just a subset of them.

Intelligent Proximity makes use of ultrasound when connecting users (see more at left). Do not block the microphone of your computer, smart phone, or tablet.

Intelligent Proximity has been designed not to work outside the meeting room when doors to the room are kept closed. You need to be in close proximity of the video device to use the feature.

When privacy dictates, always keep the meeting room entrance doors closed to avoid possible eavesdropping from adjacent rooms.



Content sharing



Share content in a call

About content sharing



In a call, connect your source and make sure it is switched on. Tap **Sharing options** and **Preview** to display the screen of your PC locally on your desk device. What you see on the screen when you do this, is not shown to the other participants.

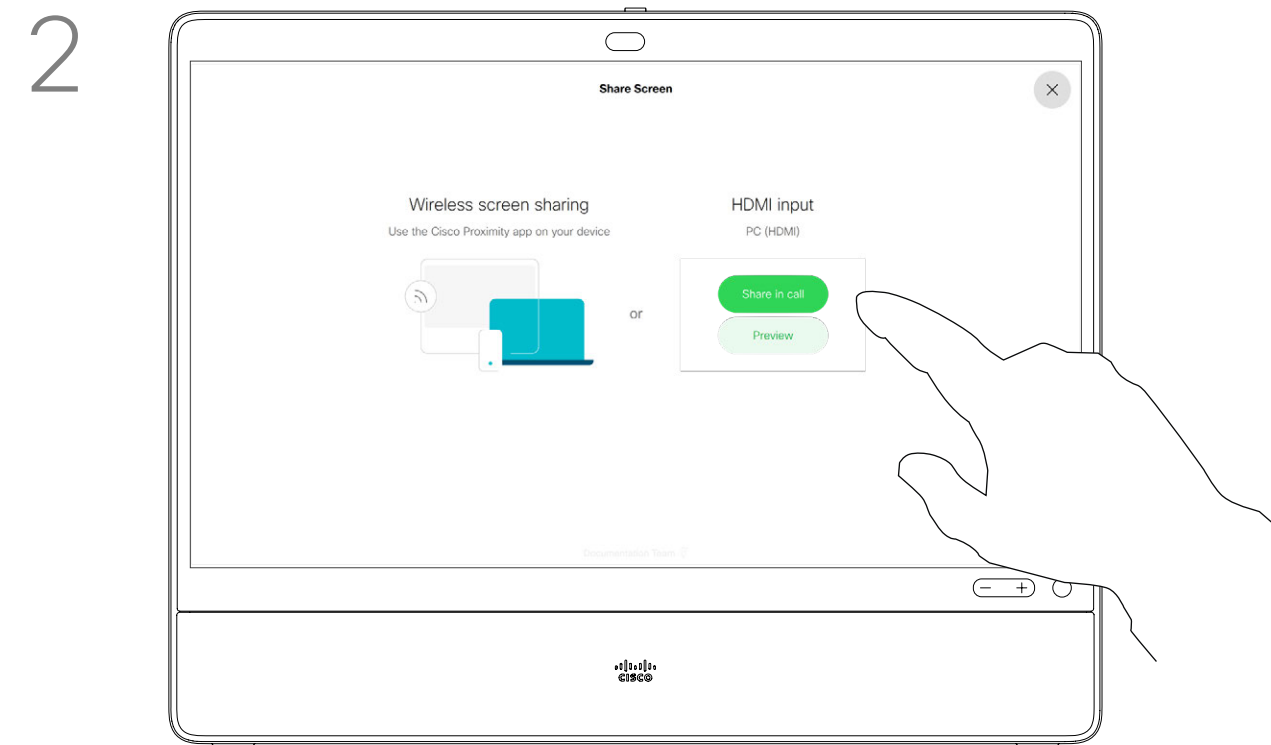

If you don't want to share your PC screen with the others tap **Sharing options** and **Stop preview** to return to the previous state. Otherwise, tap **Share in call**, as shown to proceed to sharing content.

Your device supports the ability to show presentations in a video call or video conference.

Note that you may change the layout of the screen during presentations, see the next page for more on this.

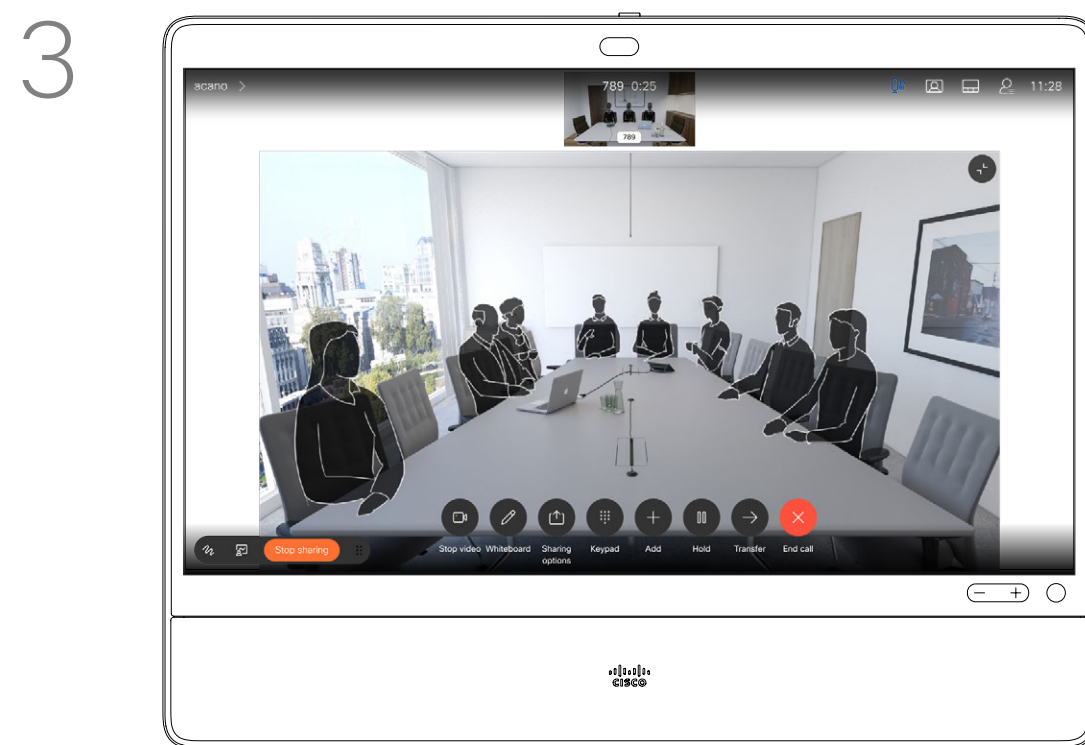

The content of your PC screen is now shared with the other participants.



To stop sharing content, tap **Stop sharing**.

Change presentation layout in a call

About presentation layout



Tap the **Layout** to invoke the layout options, as shown.

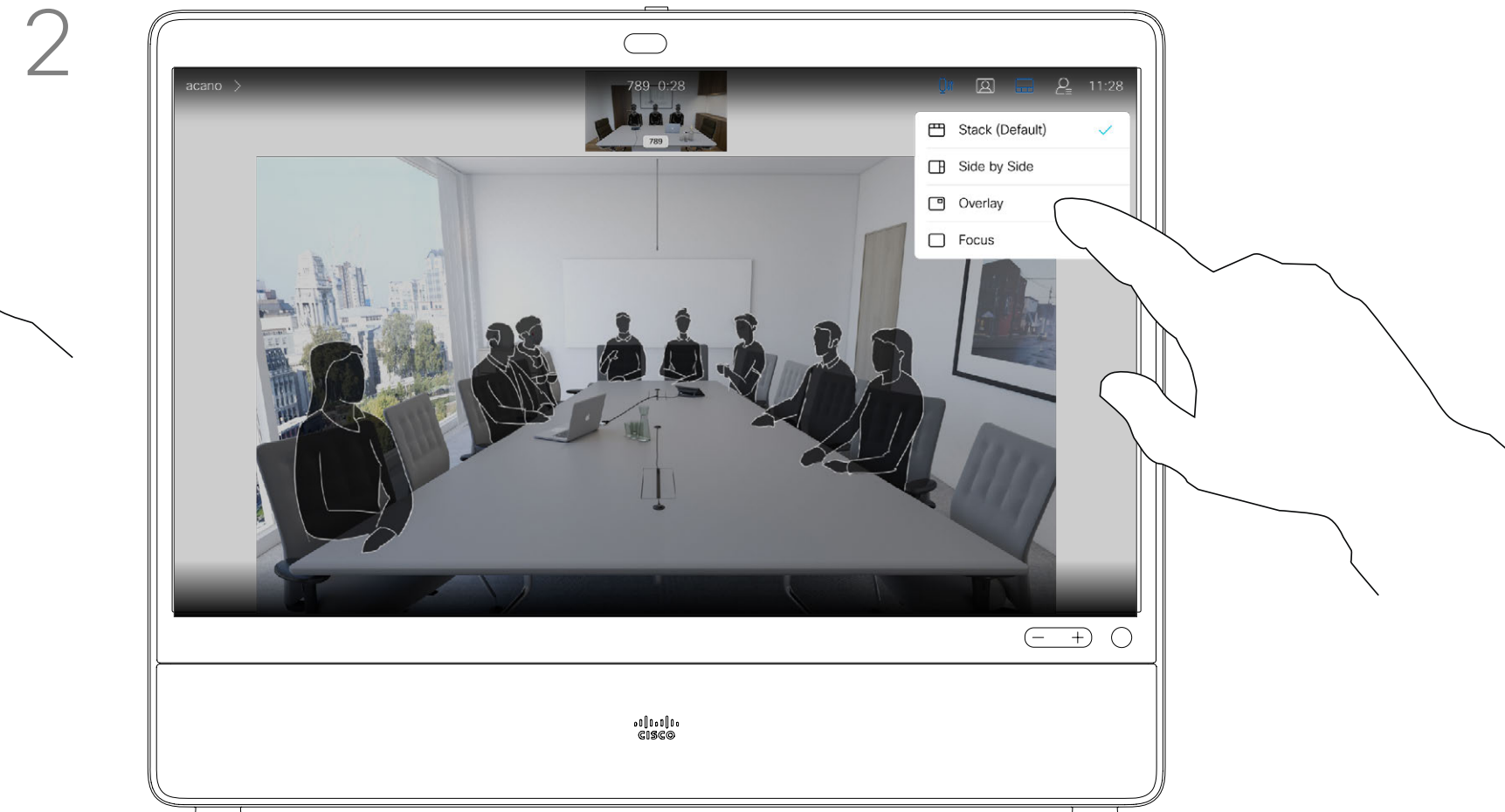

Select your preferred layout by tapping it.

You may change the layout of the screen during presentations. Typical options available are with or without showing the presenter and showing the presenter as either a PiP (Picture in Picture) or PoP (Picture outside Picture).

The layout options available on your device may differ from those shown here, but the layouts shown are always those you may choose between.

Use as a digital whiteboard

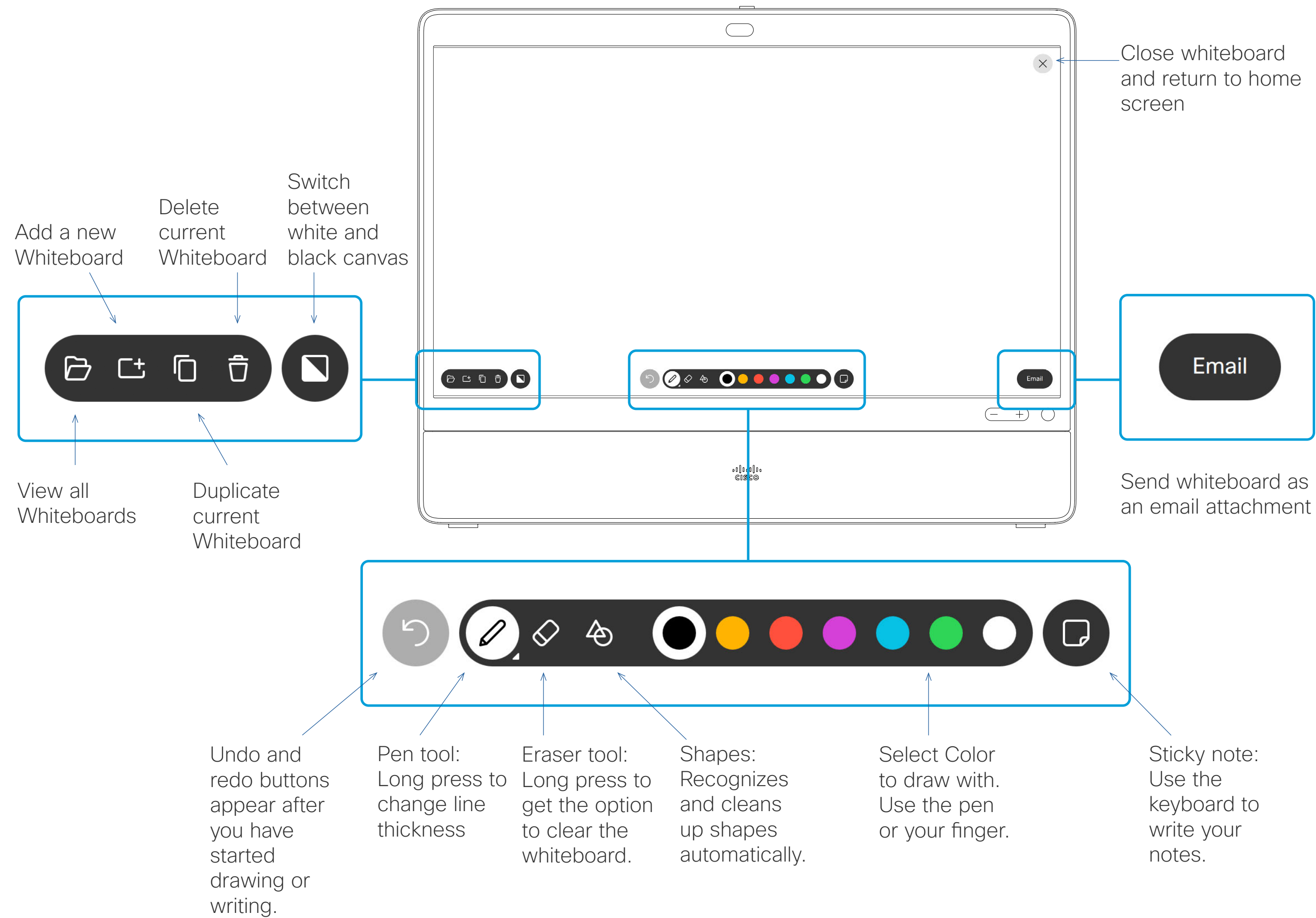

About whiteboard

You can use your Webex Desk or Desk Pro for digital whiteboarding.

To access the whiteboard function go to the home screen and then tap **Whiteboard**.

Use the stylus or your finger to write and draw.

The size of a whiteboard page is as large as you want. Use two fingers to drag the whiteboard and pinch to zoom.

To save your whiteboard drawings you may send them as emails. To be able to do this, your video support team must have configured your Webex Board to make use of a mail server.

You need to manually type in the email addresses of the recipients as directory search is not available.

The whiteboards are shared in PDF format.

To delete all whiteboards, tap the device name on the home screen and tap **End Session**.

End your session to clear your device

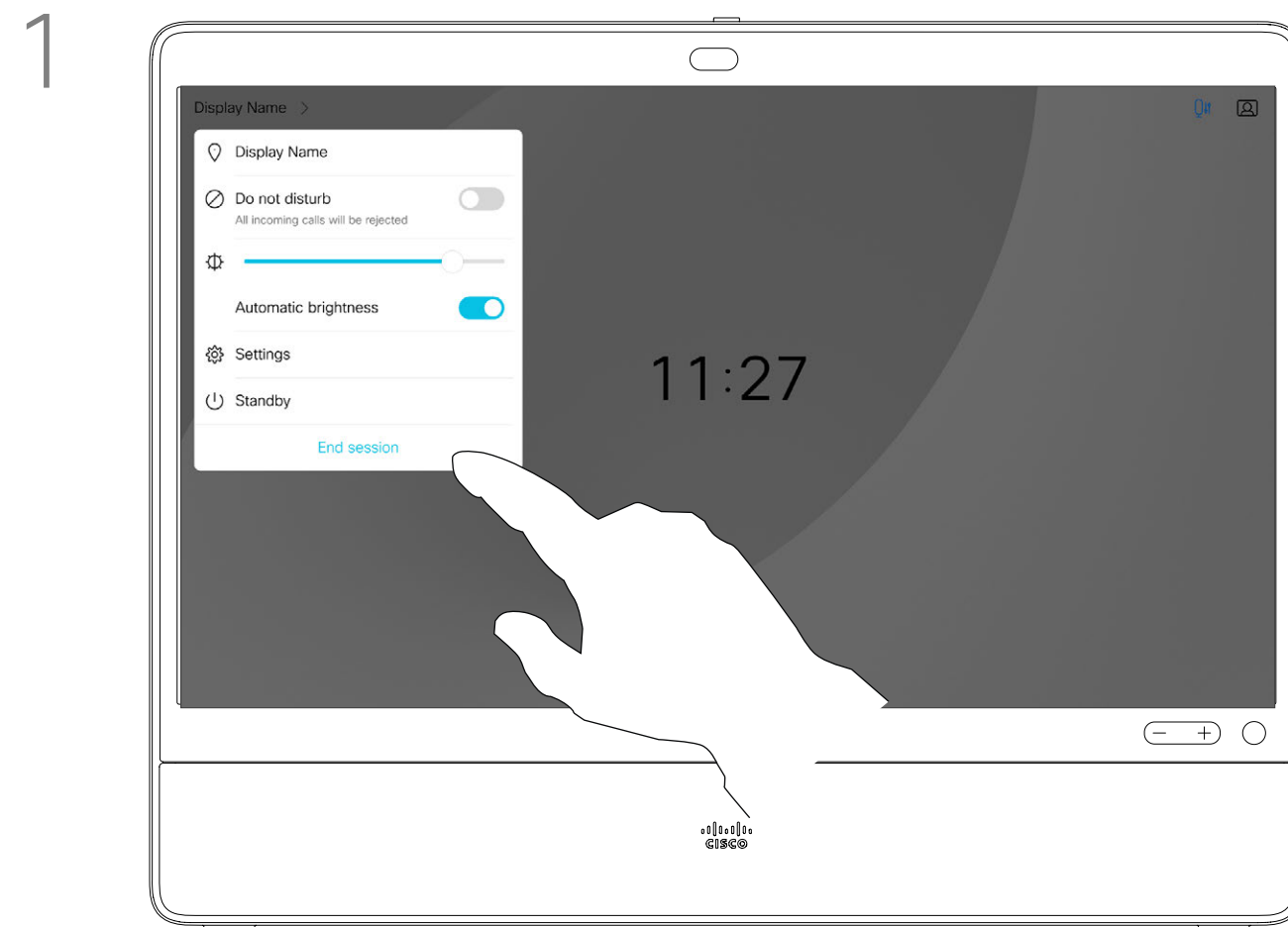

When you're ready to end your session, tap the device's name on the top left corner and select **End session**.

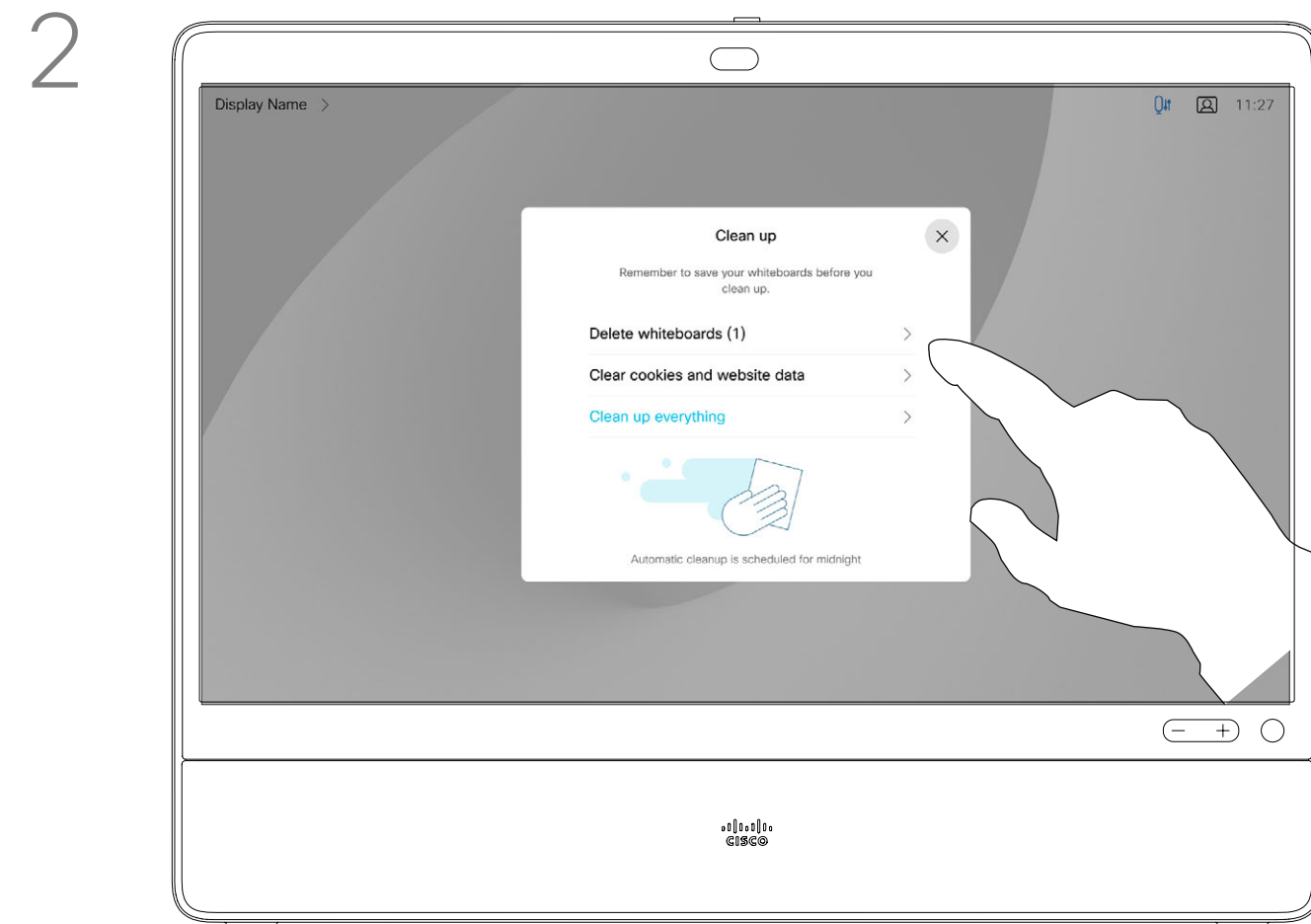

You can decide if you want to clear all whiteboards, all website data, or both. Note that deleting website data appears only if the web engine has been enabled by your system administrator.

About sessions

During a session your whiteboards, annotations, and web activity is stored on your device. You can take a break or switch between activities and then go back to your files and continue your work.

You can end your session at any time from your device, clearing up all whiteboards and browsing data for the next user.

By default, your whiteboards and web data are deleted automatically every day at midnight. See with your system administrator if the automatic cleanup is disabled or set to occur at a different time.

Wired touch redirect

You can control your laptop from the Desk Pro screen. This works when you have connected your Windows 10 laptop to the Desk Pro with an HDMI cable and a USB-C cable. It is well suited for tasks that involve drag and drop, drawing programs, and maps.

Touch redirect is available if you're sharing locally or sharing in a call.

The feature is tested and verified with Windows 10. Basic functionality should also work with another OS.

Limitations:

- When you use touch redirect, you can't use annotation on the screen you are sharing.
- Volume control on the Desk Pro is not available when touch redirect is in use. Use the volume control from your laptop.

Enable drag and drop in your browser

To use touch redirect for drag and drop on your browser, you need to enable this on your browser.

- Chrome: go to **chrome://flags/#touch-events** and set to **Enabled**.
- Firefox: go to **about:config** and set **Dom.w3c_touch_events.legacy_apis.enabled = true**.
- Edge: go to **about:flags** and set **Enable Touch Events = always on**.

Use touch redirect with Windows 10 laptops

1. Switch your laptop to tablet mode by selecting the action center on the taskbar next to the date and time, and then select **Tablet mode** to turn it on.
2. Connect your laptop to a Desk Pro with an HDMI cable and a USB-C cable. You can use either a USB-C-USB-C cable, or a USB-C-USB-A cable.
Note: USB-C-USB-A cables are supported for longer cable lengths.
3. Select **Share** from the home screen and tap the **Touch Redirect** button.

If you want to switch to other activities on the Desk Pro while you're using touch redirect, tap the **Touch Redirect** button and tap the screen to get access to home screen.

Content sharing Web apps



About web apps

A web app is a web page or application that you can access from the home screen of the device. You can share and work on a web app locally or in a call.

A web app launches in full screen, and times out after 15 minutes if not being used. The web app may be interactive.

When you open a web app in a call, it will be automatically shared. It's not possible to preview the web app while in call.

When presenting a web app that plays audio but doesn't allow volume control, you can't adjust the audio that's shared to the participants. Data, such as cache, cookies, and local storage, is automatically cleared when the session ends.

You can add, delete, and edit web apps directly from the settings menu on your device.

Tap on the device's name in the top left and select Settings. Go to Manage Web Apps. You can add a web app, but also edit or delete them.

The web apps configured in the UI extension editor are visible in the web apps list under Externally Managed Web Apps, but it is not possible to edit or delete them from the device.



Scheduled meetings



Join a scheduled meeting

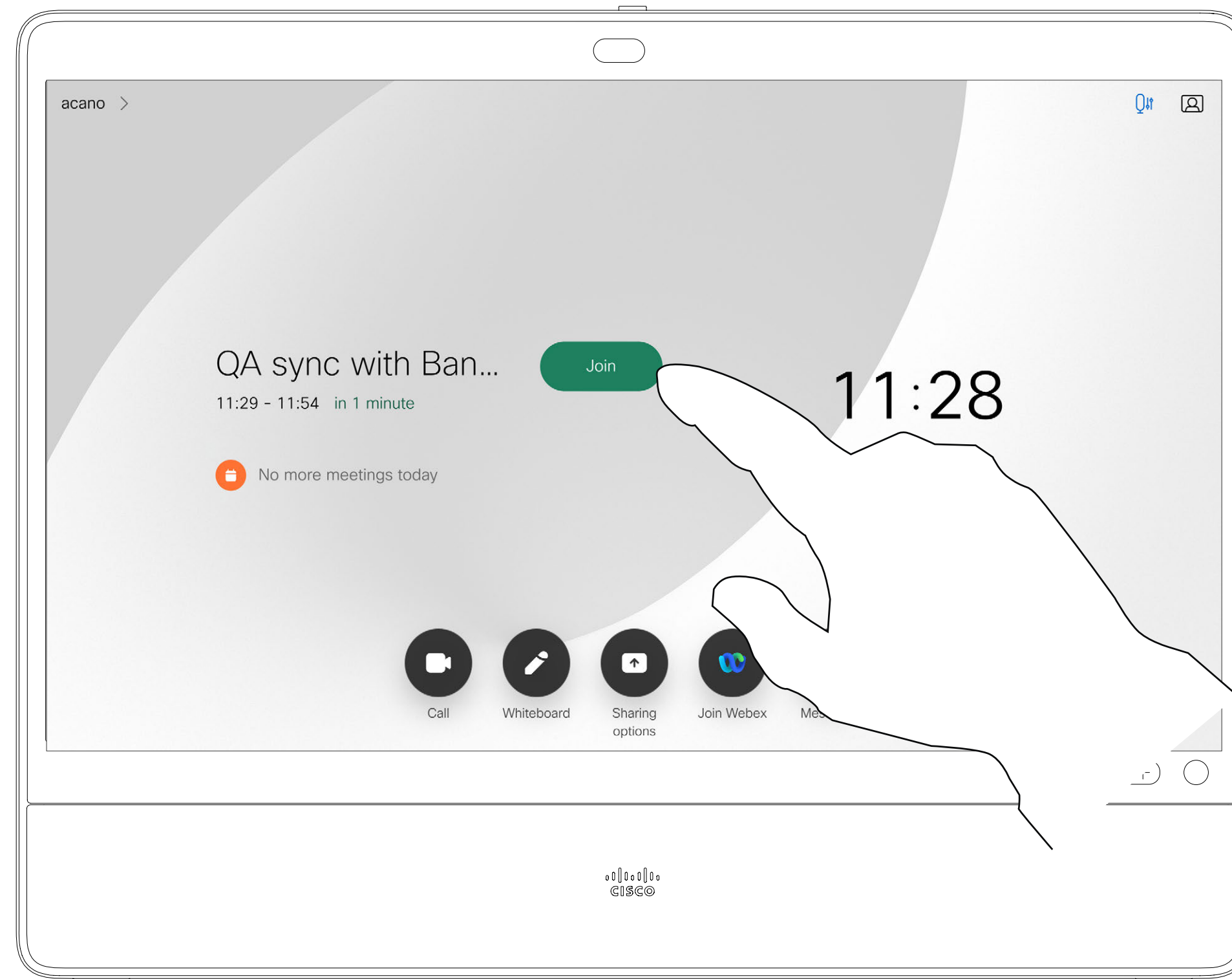

Joining a meeting

Your device may be connected to a management system capable of scheduling video meetings. Any meetings scheduled then appear as shown at left.

Tap **Join** to participate in the meeting.

Should the meeting have started already, you may still join.

When a scheduled meeting appears on the device screen, the device wakes up from stand-by.

Scheduled meetings

Join a Webex meeting

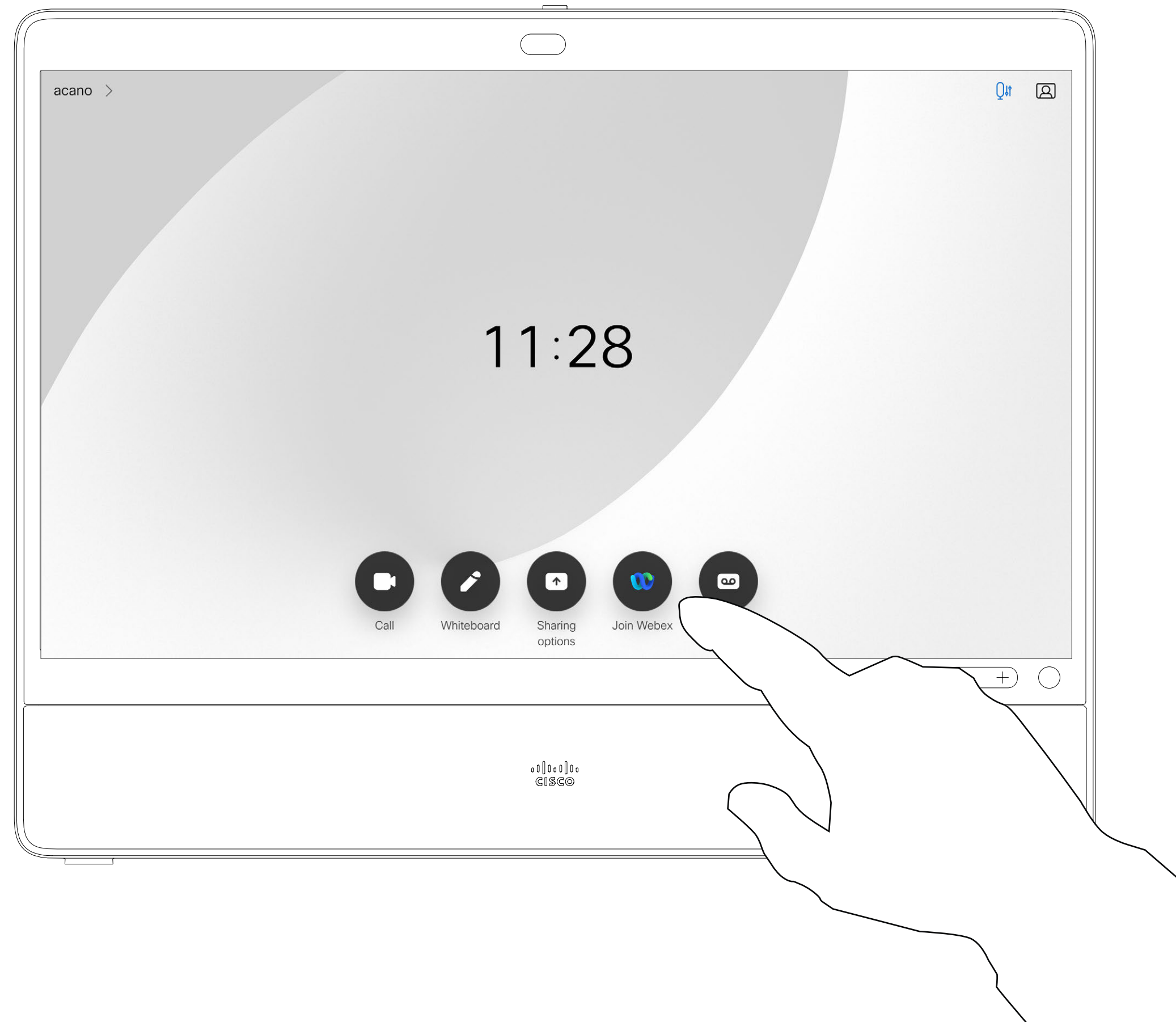

Tap **Join Webex**. You are prompted to key in the meeting number you received in your invite. Tap **Join** to join the meeting.



Contacts

Contacts

Favorites, Recents, and Directory

About the contacts lists

Your lists of Contacts consist of three parts:

Favorites. These contacts are put there by you. These entries are those you call frequently or otherwise need to access in a swift and convenient manner from time to time.

Directory is typically a corporate directory installed on your device by your video support team.

Recents is a list of calls you have placed, received or missed earlier.

Note that removing entries from *Recents* can only be done from the web interface.

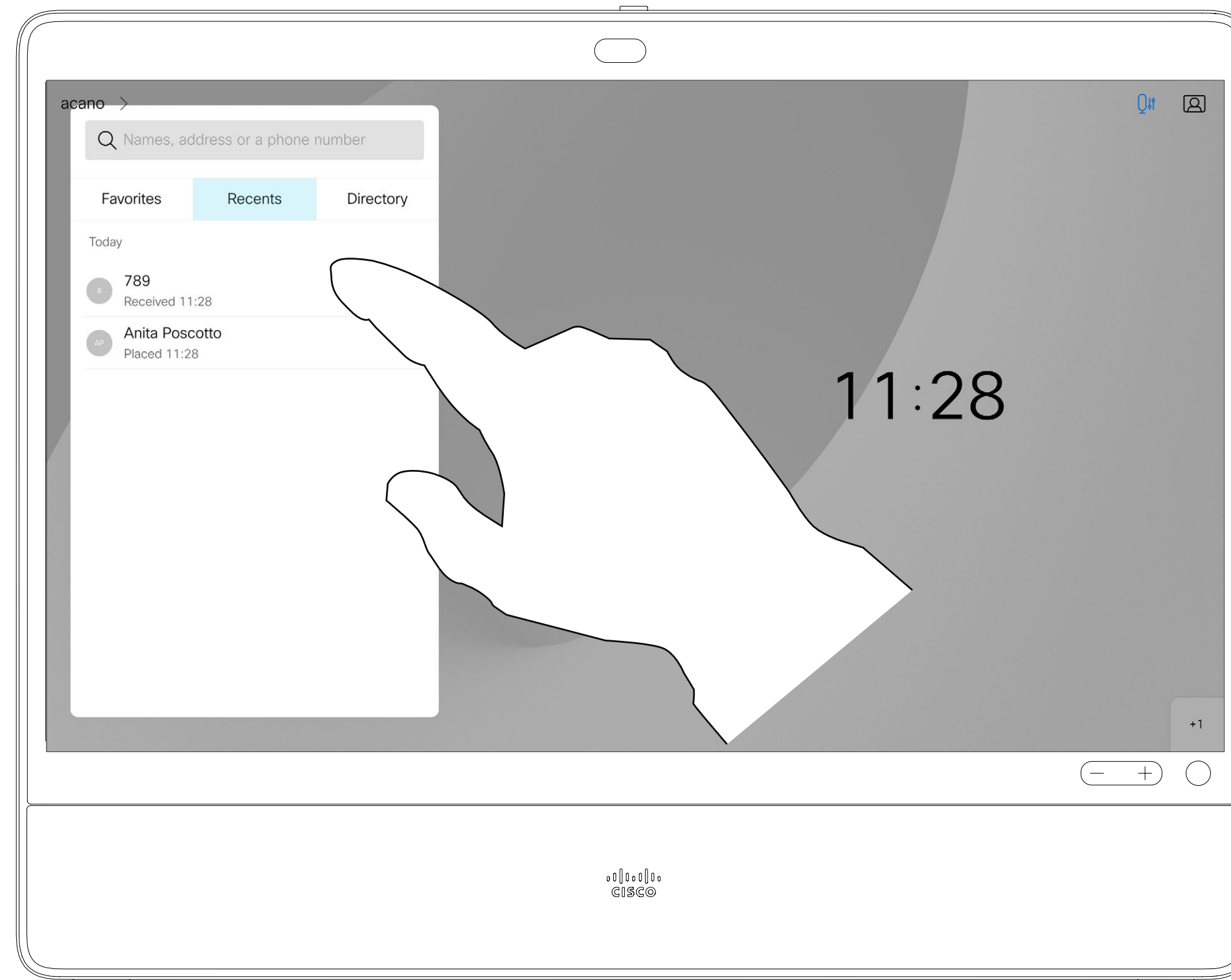

Add someone to Favorites, while in a call

About Favorites

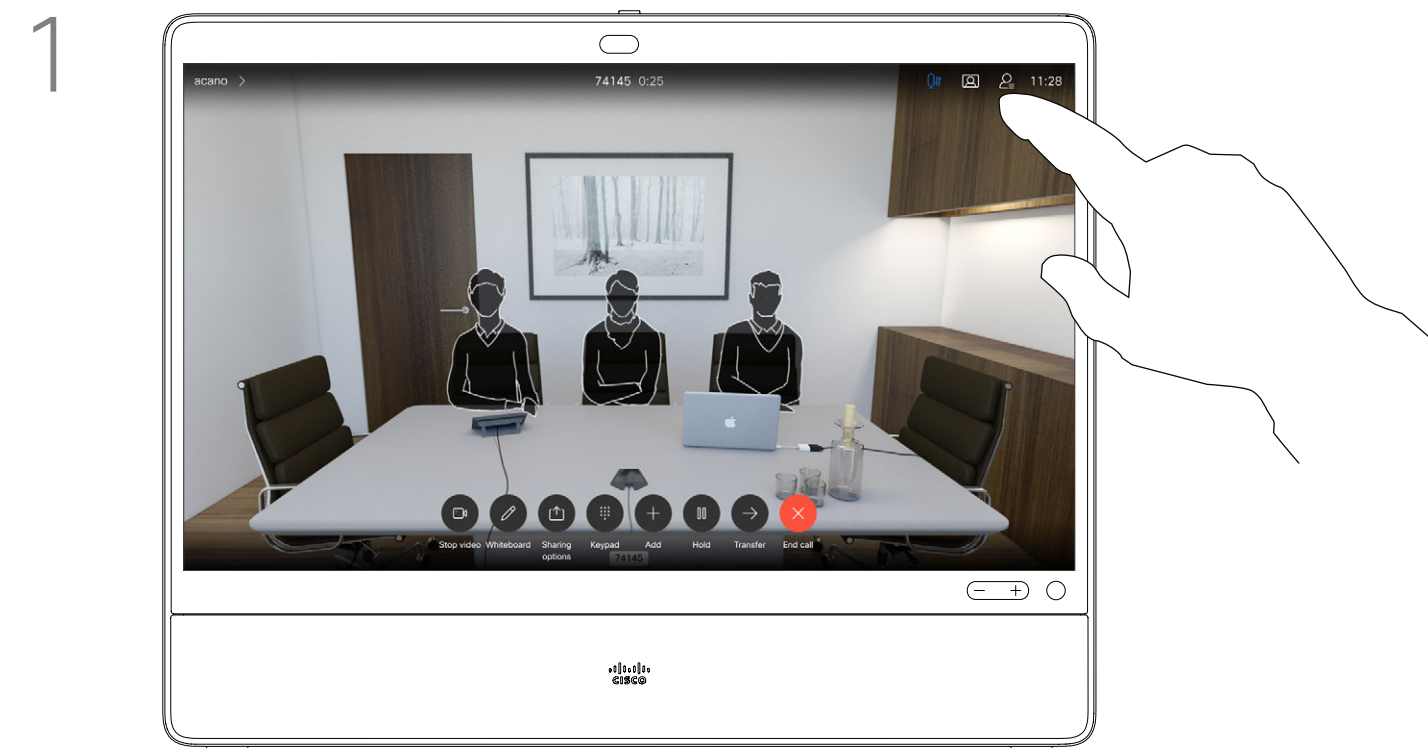

In a call, tap the **Participants** icon in the upper right corner, as shown, to invoke the list of participants.

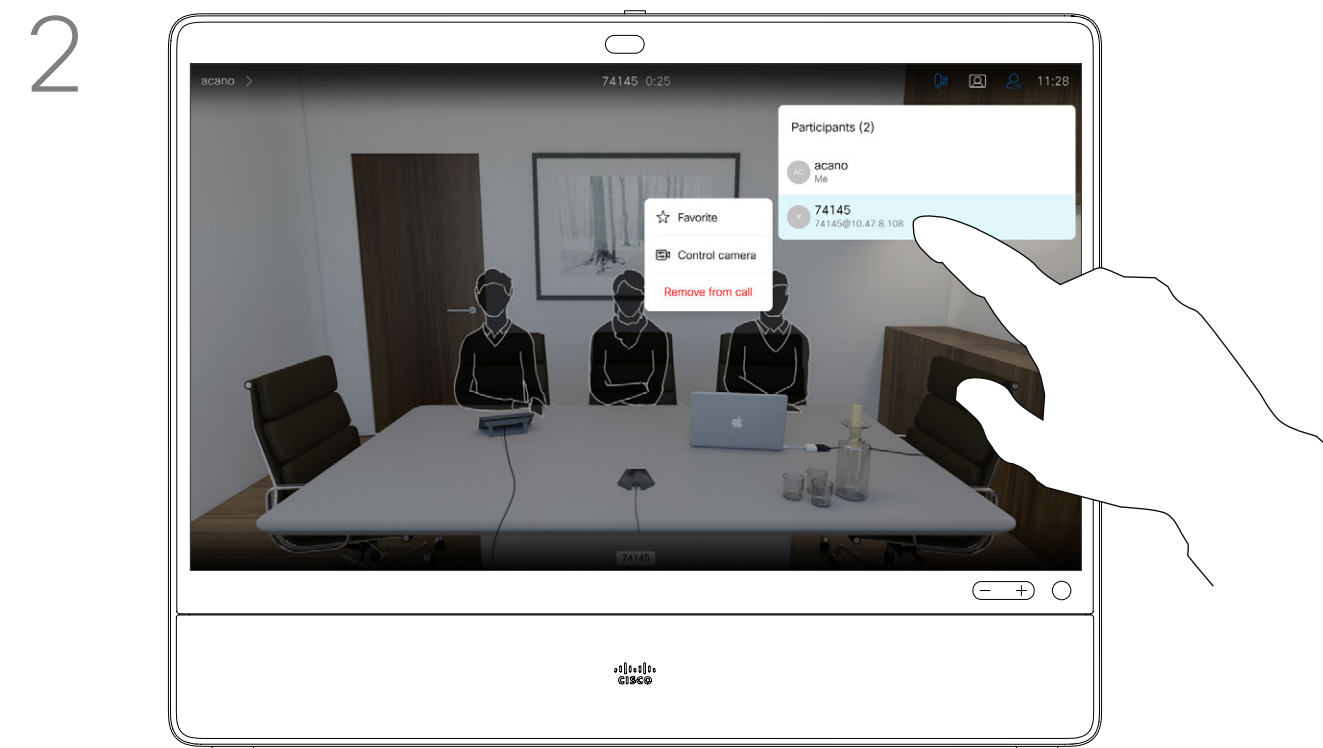

Tap the participant to be turned into a Favorite. A small menu allowing you to drop that participant (terminate that participation) or to add the participant to the list of favorites.

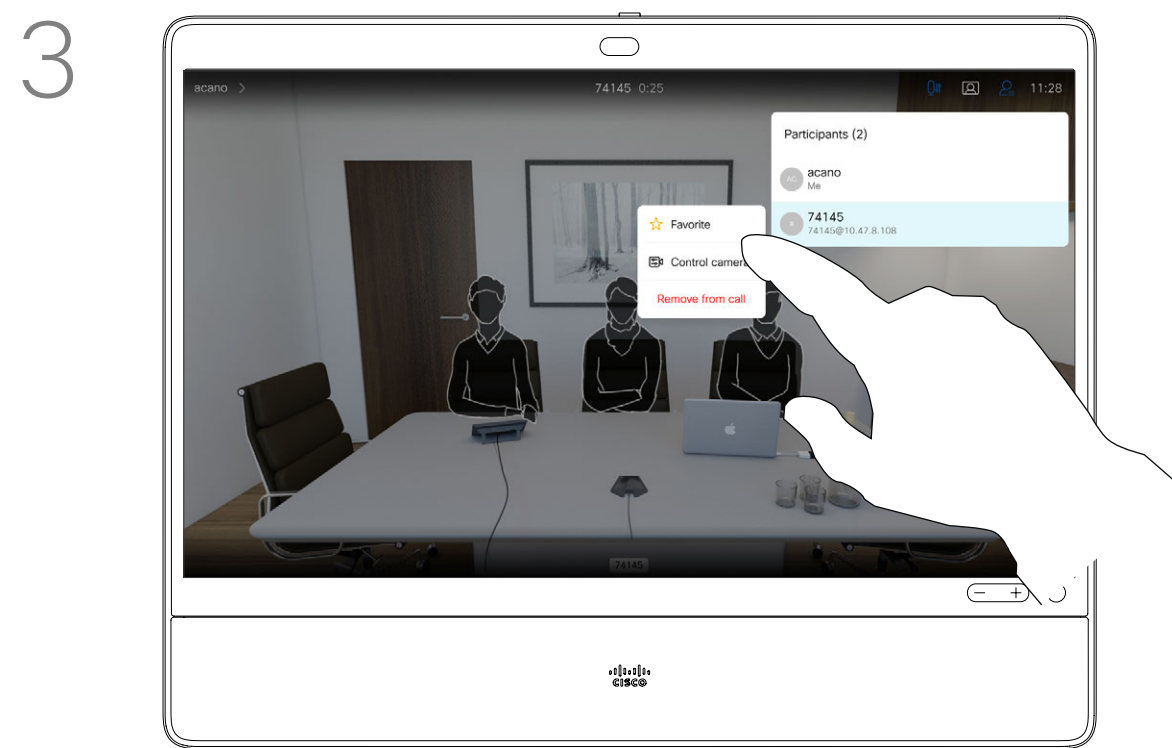

Tap **Favorite**.

The *Favorites* is your own shortlist of contacts you frequently call or otherwise want to have easy access to.

Favorites may be populated from the *Recents* or *Directory* lists as well as from manual entries.

Add someone to Favorites, outside a call

About this feature



While not in a call, tap **Call** (not shown) to invoke the *Contacts* list, as shown. Tap **Recents** or **Directory** and search for the entry to become a Favorite.

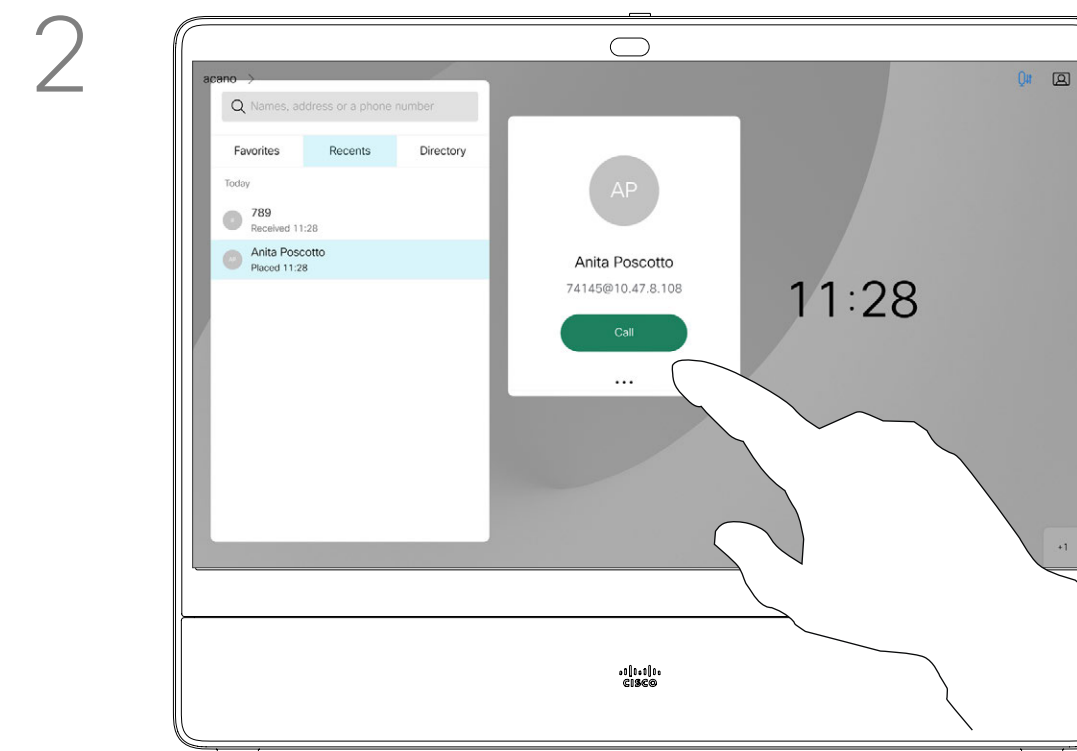

Tap the participant you want to add the *Favorites* list. Tap the **More (...)** icon below the green **Call** button.

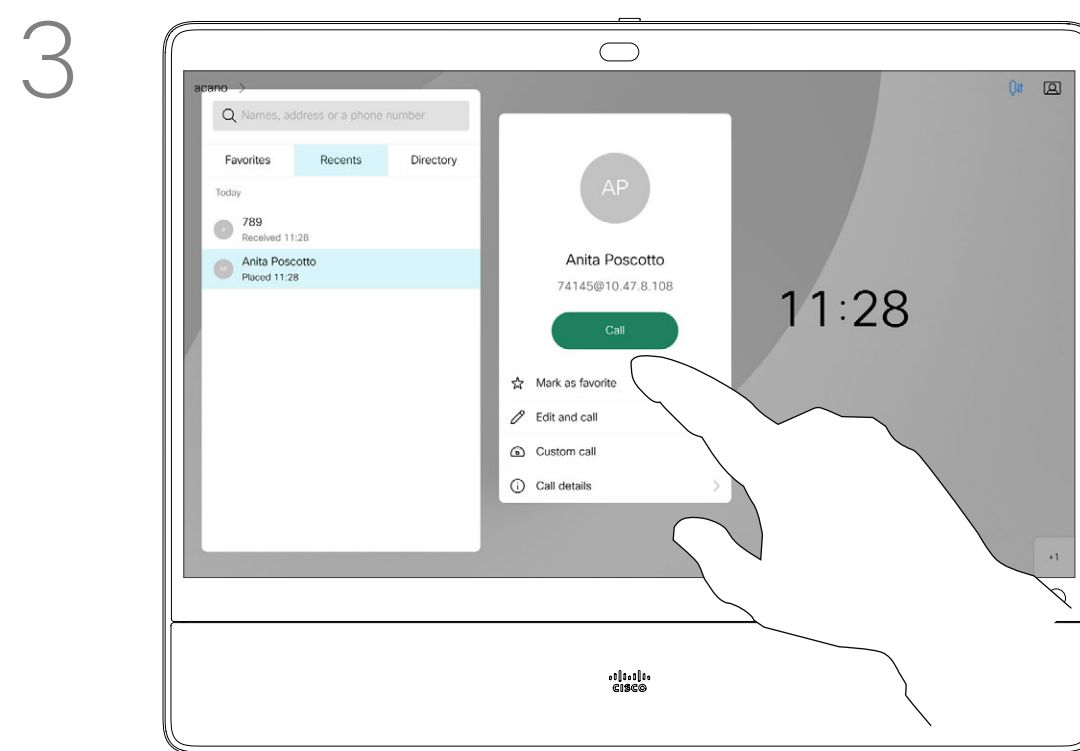

Tap **Mark as Favorite**. The entry has now become a Favorite. Tap anywhere outside the menu to exit.

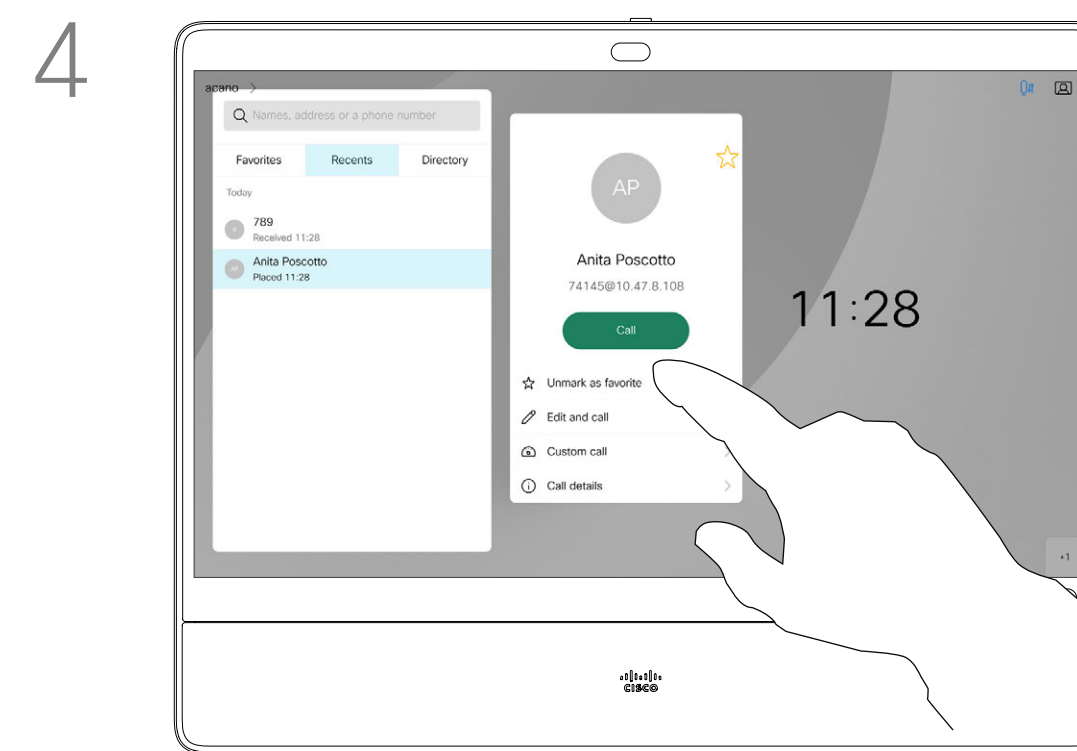

A Favorite is denoted by a golden star, as indicated. To remove an entry from the list of *Favorites*, go to **Favorites** in the *Contact* lists and repeat the procedure.

The *Favorites* is your own shortlist of contacts you frequently call or otherwise want to have easy access to.

Favorites may be populated from the *Recents* or *Directory* lists as well as from manual entries.

To add a manual entry to the list of Favorites, type the name or address in the *Search* or *Dial* field as explained in ["Place a call using name, number, or address" on page 18.](#)

Contacts

Edit an existing Favorite

About this feature

This feature allows you to update a Favorite at all times.



Tap **Call** (not shown) to invoke the Contacts list, as shown. Then tap **Favorites** to gain access to the list of Favorites.

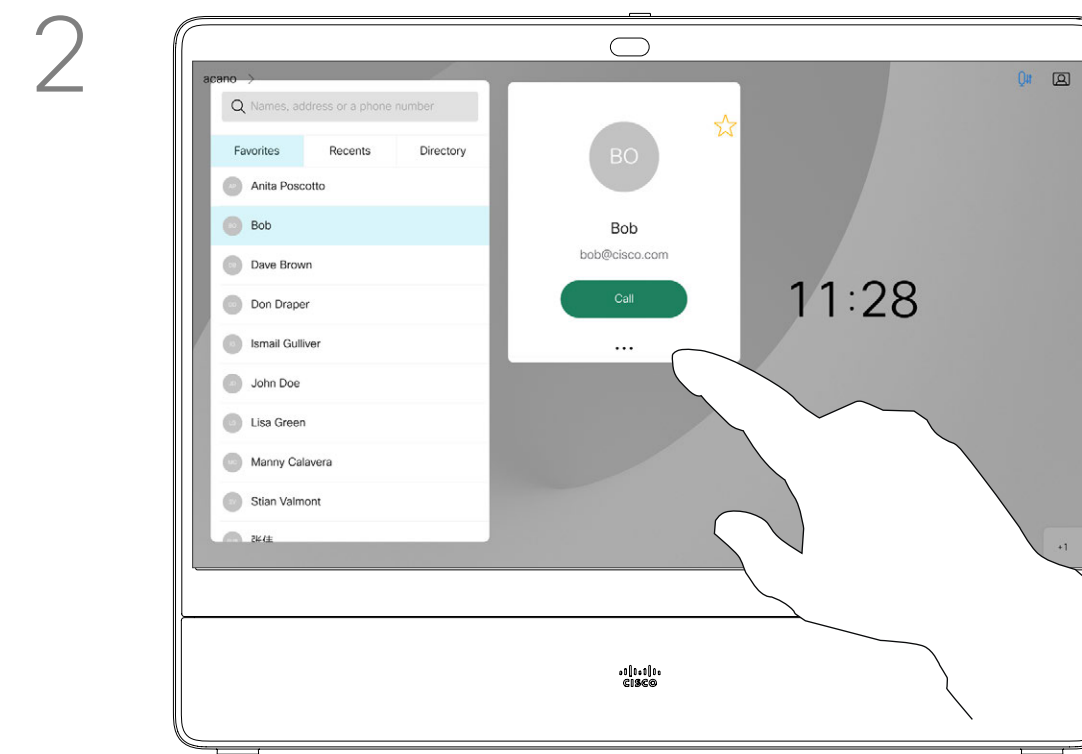

Tap the Favorite to be edited. Now tap **More**.

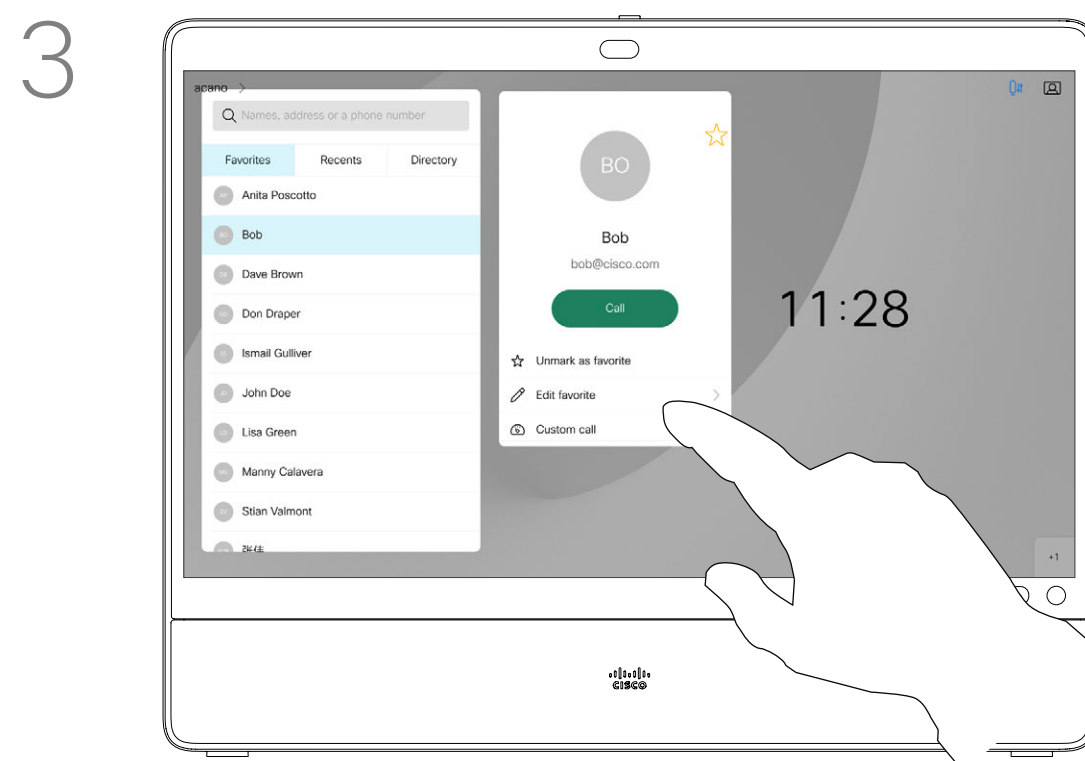

Tap **Edit Favorite**.

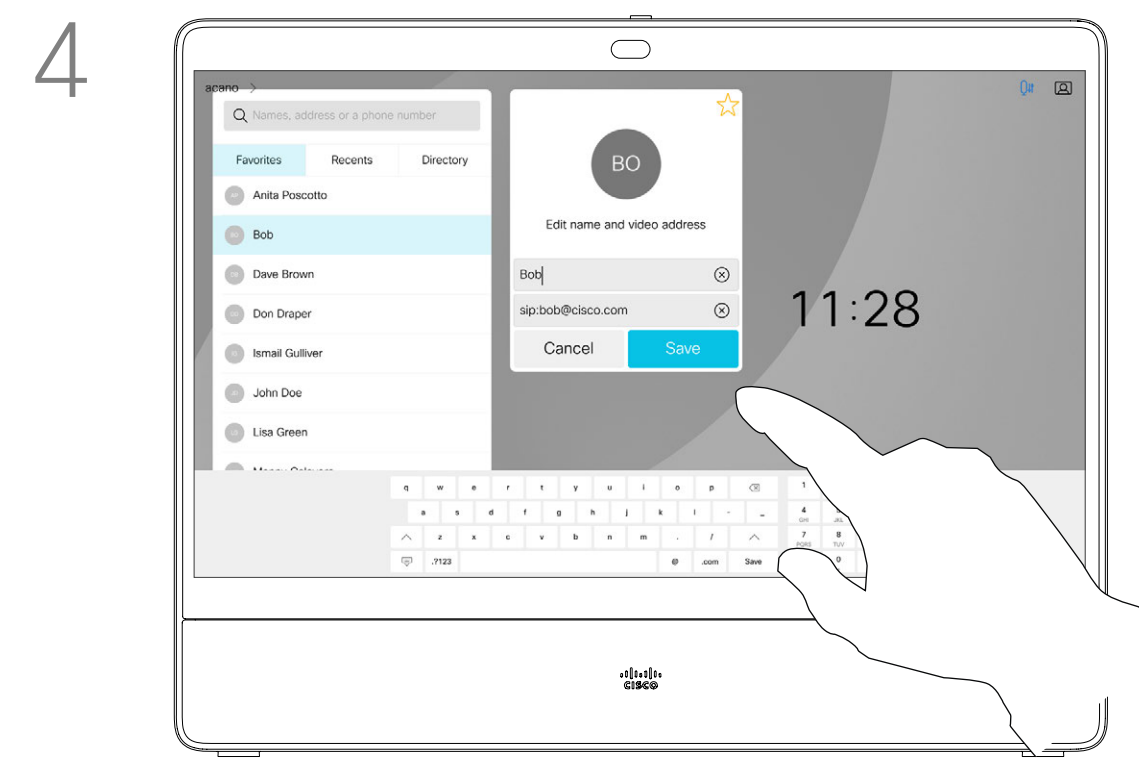

Edit the Favorite entry and tap **Save** to exit putting changes into effect. Otherwise tap **Cancel**.



Camera control



Turn selfview on and off

Why selfview?

Selfview shows what others see from your device. You can use it to confirm that they see what you want them to see.

The selfview appears as a PiP (Picture-in-Picture).

From time to time you may want to have the selfview activated during the meeting. This could, for example, be to ensure that you remain seen on the screen.

Tap as shown at left to activate or deactivate the Selfview.

It may happen that the current position of the selfview blocks important parts of the image on your screen. You may therefore want to move it (see the next page for more).

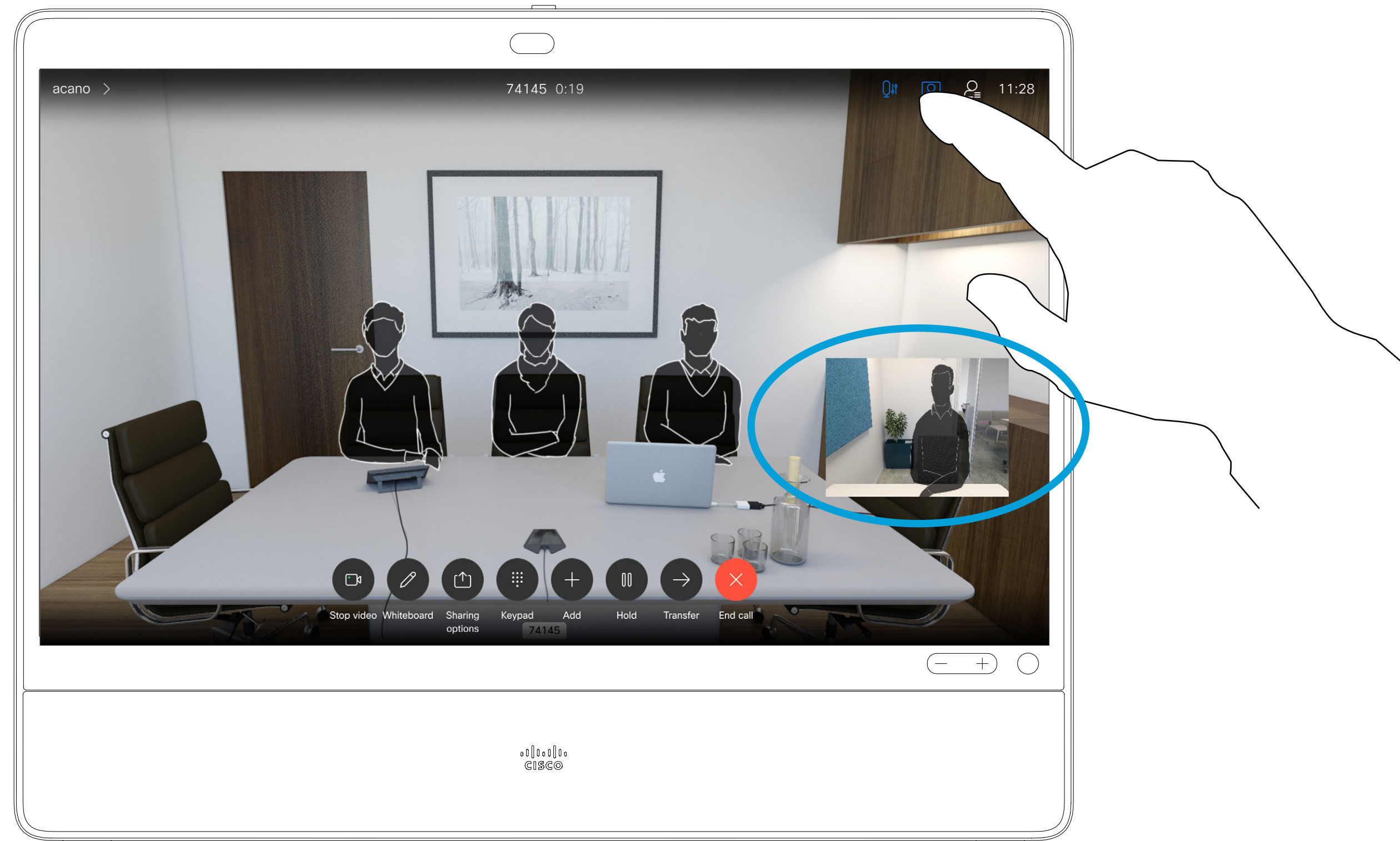

Move the selfview PiP

Why move the selfview?

1



Tap and hold the selfview image.

2

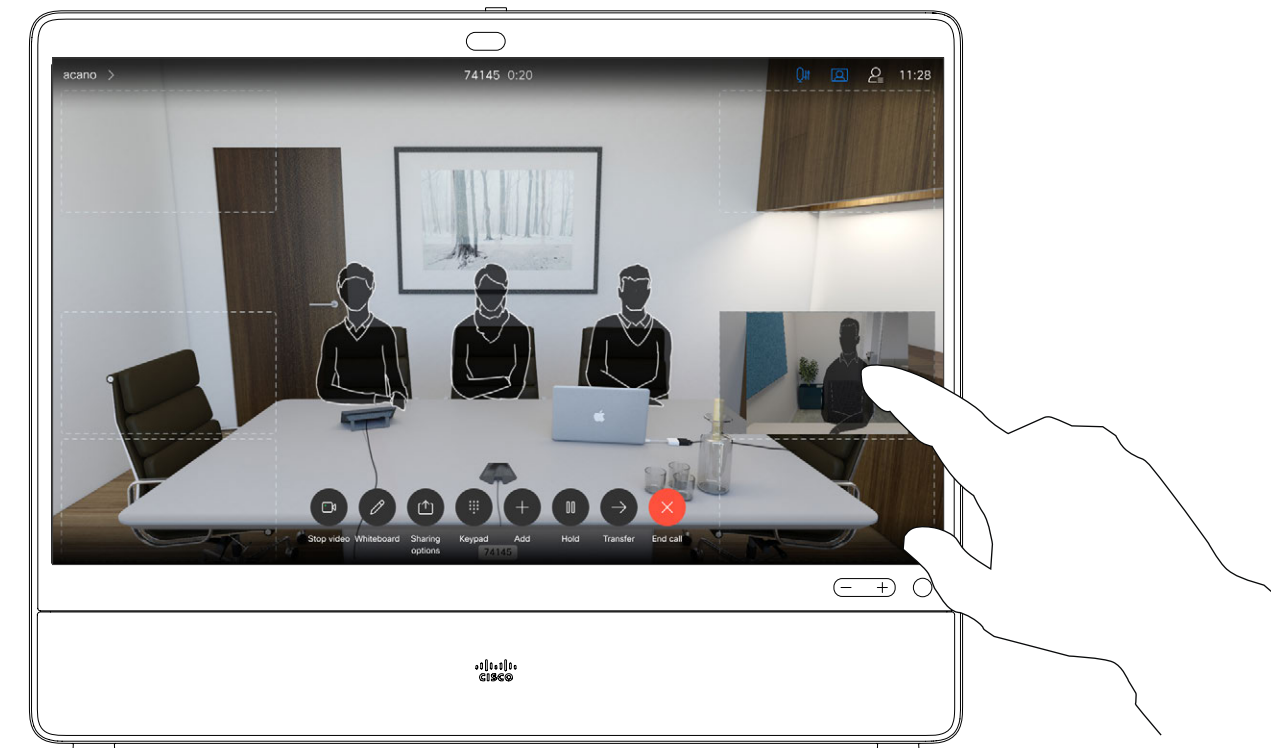

You will now see the alternate positions available for the selfview image. Keep holding the image.

3



Drag the image to a new position, shown here is the upper left corner.

4

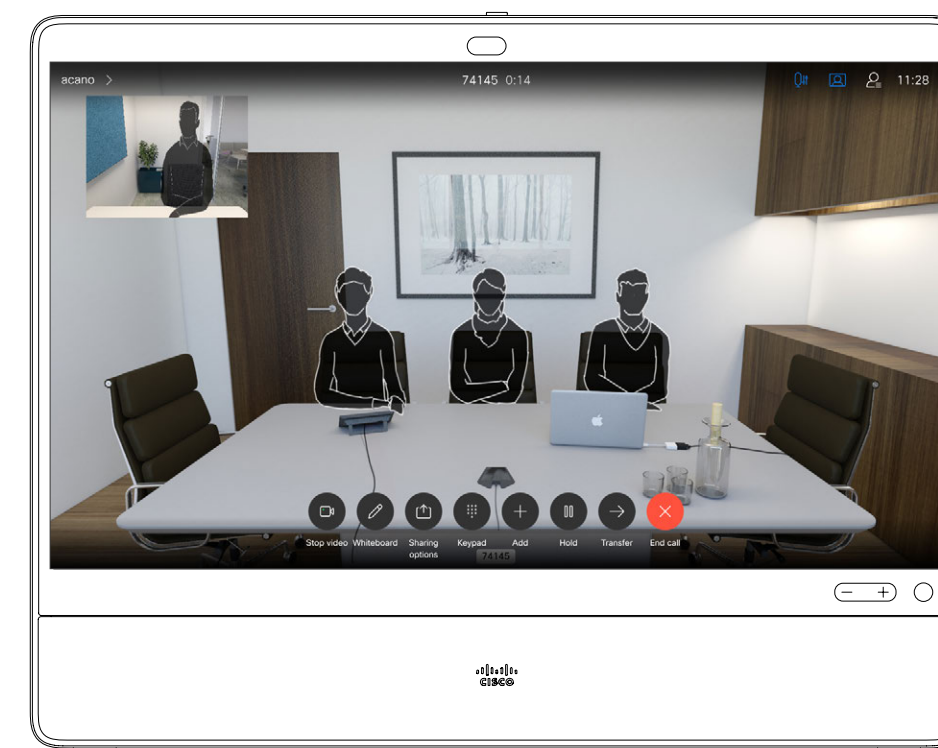

Release the image by lifting your finger from the screen. The selfview image has now assumed its new position.

Selfview shows what others see from your device. You can use it to confirm that they see what you want them to see.

The selfview appears as a PiP (Picture-in-Picture).

From time to time you may want to have the selfview activated during the meeting. This could, for example, be to ensure that you remain seen on the screen.

It may happen that the current position of the selfview blocks important parts of the image on your screen. You may therefore want to move it.

Camera control

Far-end camera control

About camera control

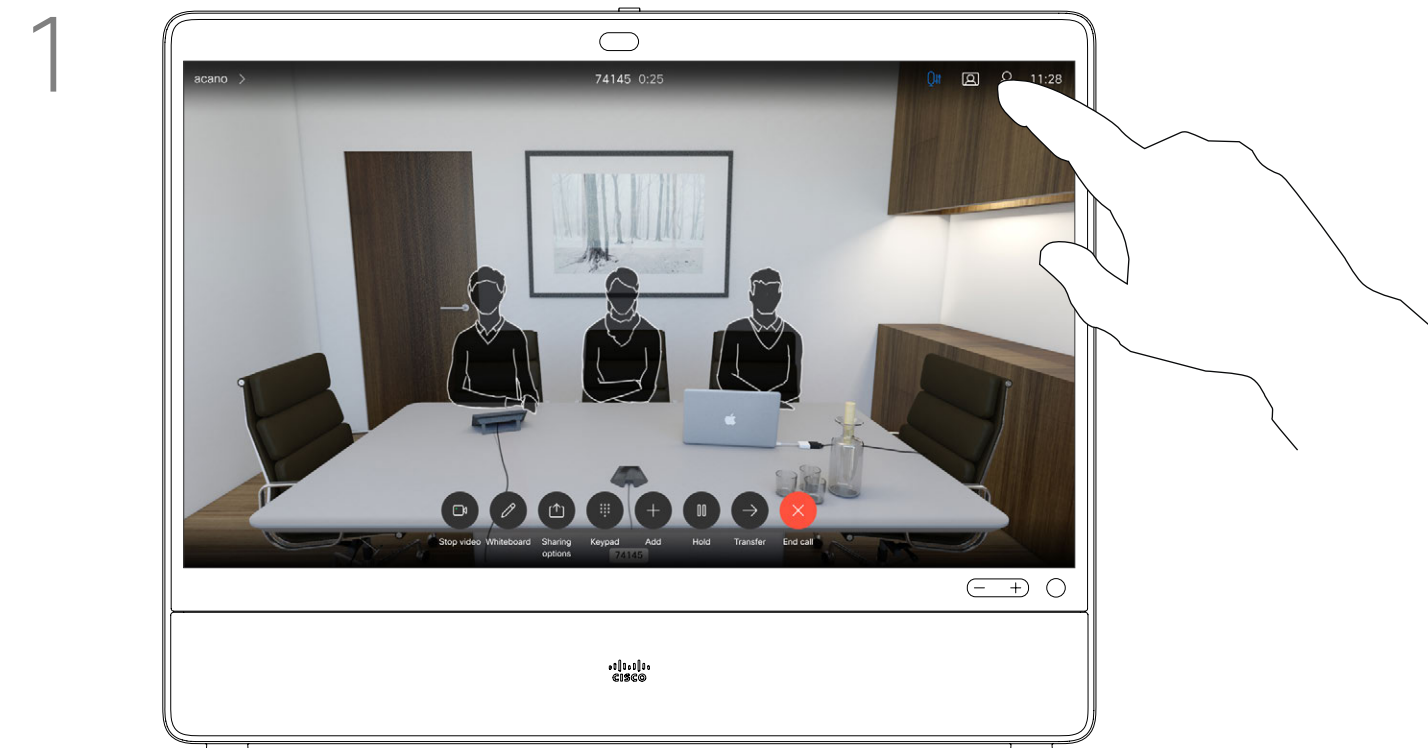

Tap the **Participant** icon.

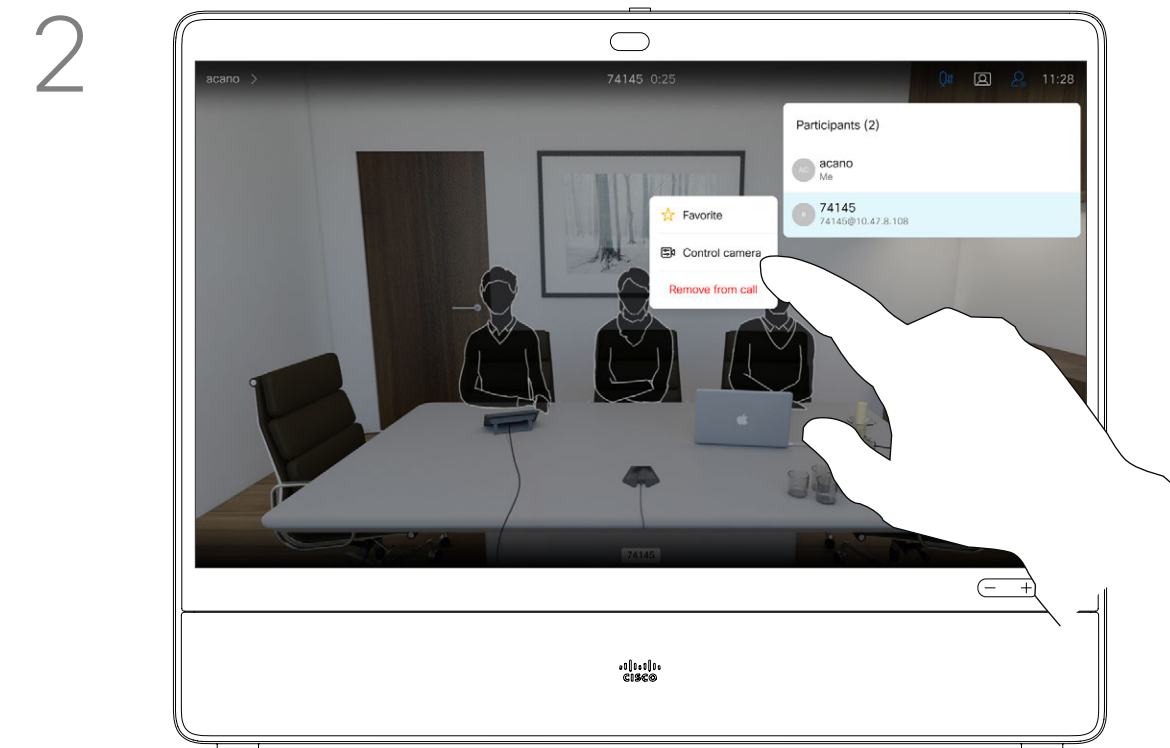

Tap the participant, whose camera you want to control, then tap **Camera**.

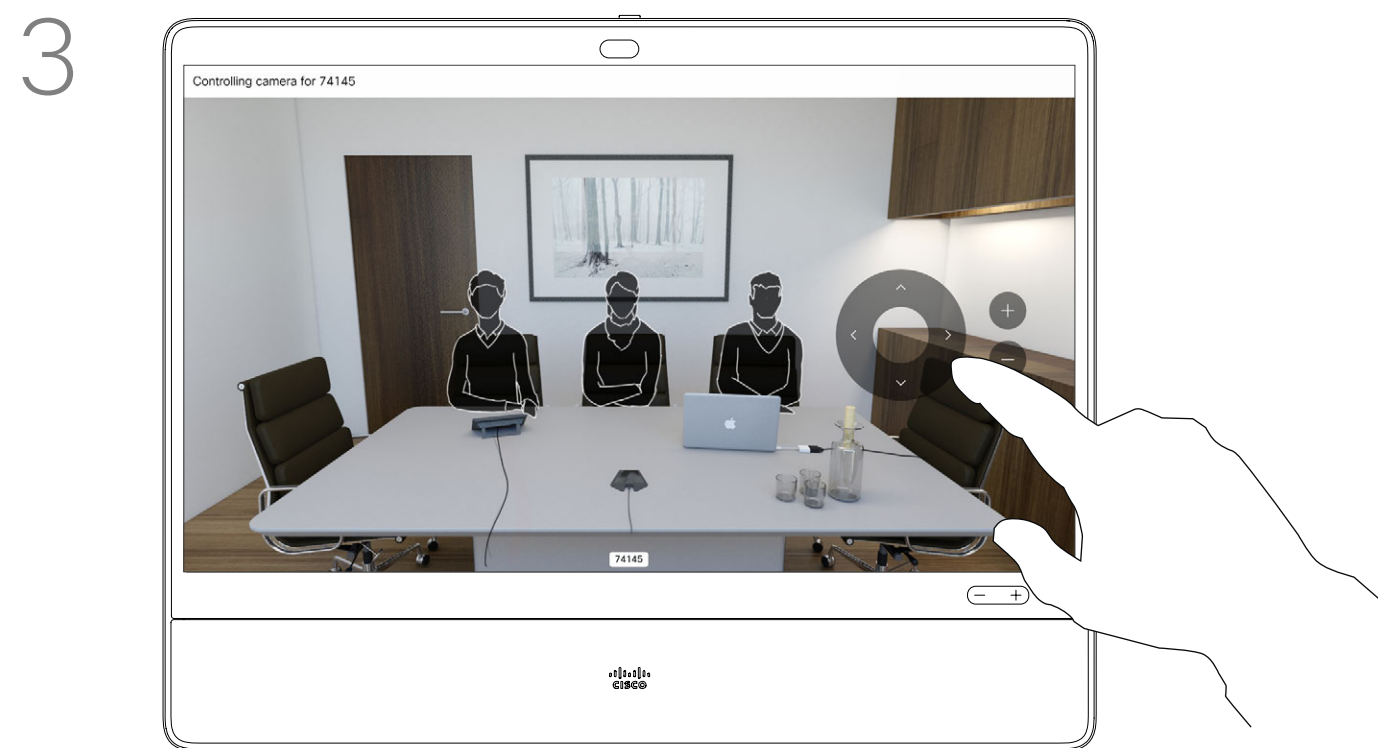

Use the Pan, Tilt, and Zoom controls as required.

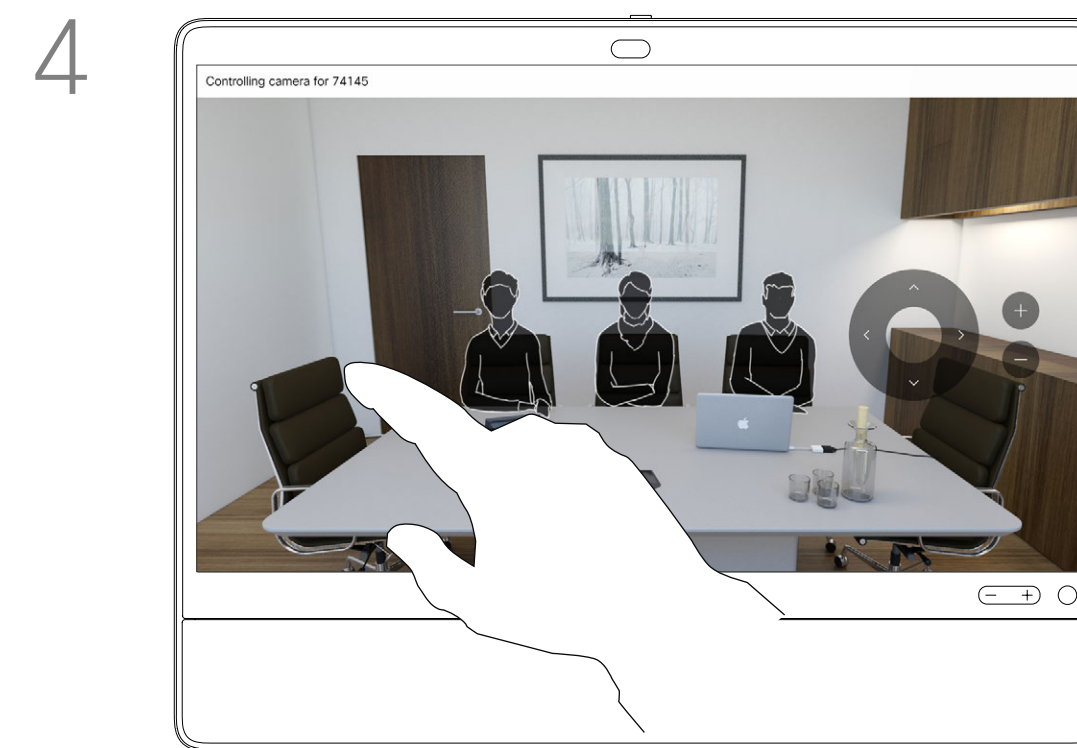

Tap somewhere outside the controls when you are done.

You may be in a video call, in which one or more of the other devices have a remotely controllable camera.

You can then control those cameras from your own device. This is referred to as Far-End Camera Control (FECC).

If the far-end device has activated camera tracking (which takes place when the camera tracks and shows who is speaking) you don't see the option of FECC.

Camera control

Virtual backgrounds



Tap the **Selfview** icon.



Tap the selfview image to open background options.



Select blurred or image background.



Tap the screen outside the controls when you are done.

To close selfview, tap the **Selfview** icon again.

About backgrounds

With video backgrounds you can change or blur the background of the image others see in the video meeting. This helps you to be the focus of the image or hide a messy background at the office.

To enable video backgrounds, go to **Settings**, select **Video Backgrounds** and toggle **Backgrounds On**.

Background options:

- Background blur
- Computer screen share as background (if your computer is connected to the desk device)
- Three standard background images
- Custom background image (if custom images have been uploaded by your administrator)

NOTE: The blurring may not cover the background entirely and possible sensitive information may be visible to others in the video meeting.

Camera control

Immersive share

About immersive share



In a call, start sharing content from your laptop. Tap the **Immersive Share** icon in the floating toolbar on the left side of the screen.



Select one of the locations on the screen and toggle on **Show me in front of presentation**. You can change your position on the screen during your presentation. Tap the Immersive Share icon and choose another location.

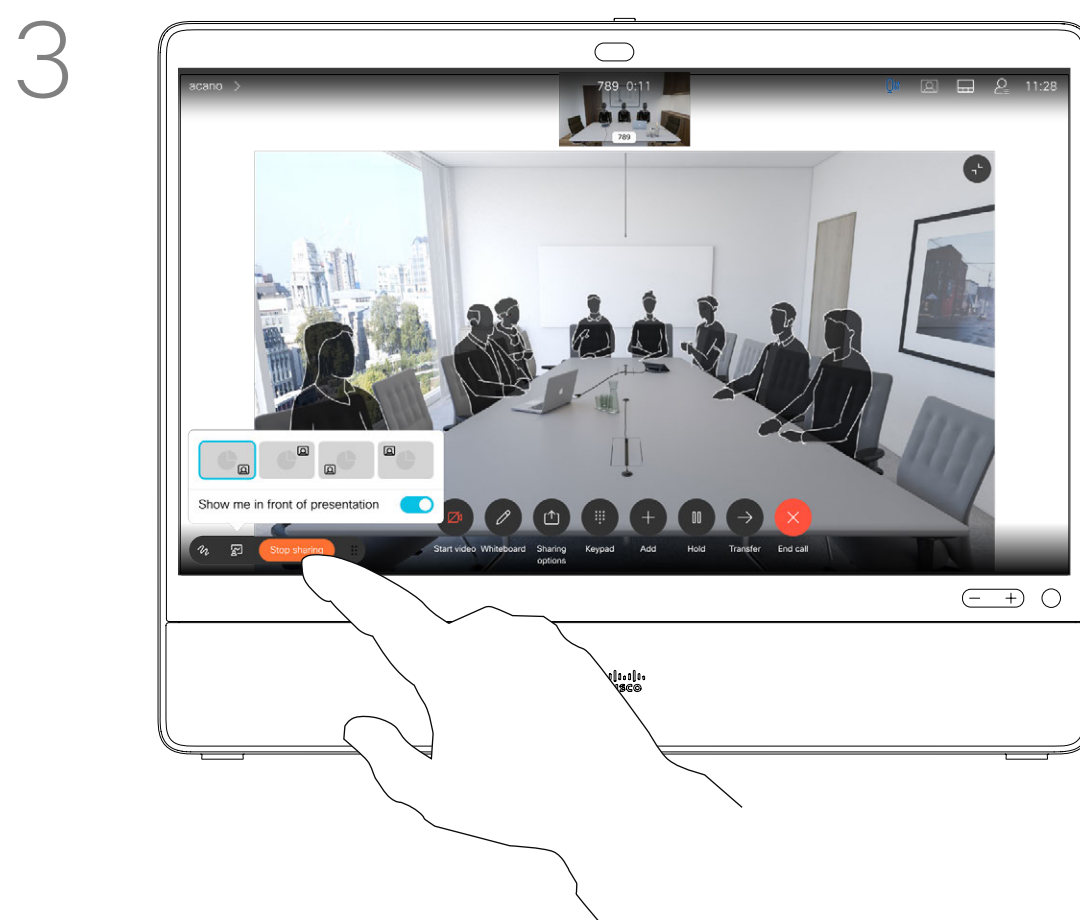

Tap **Share** in call.

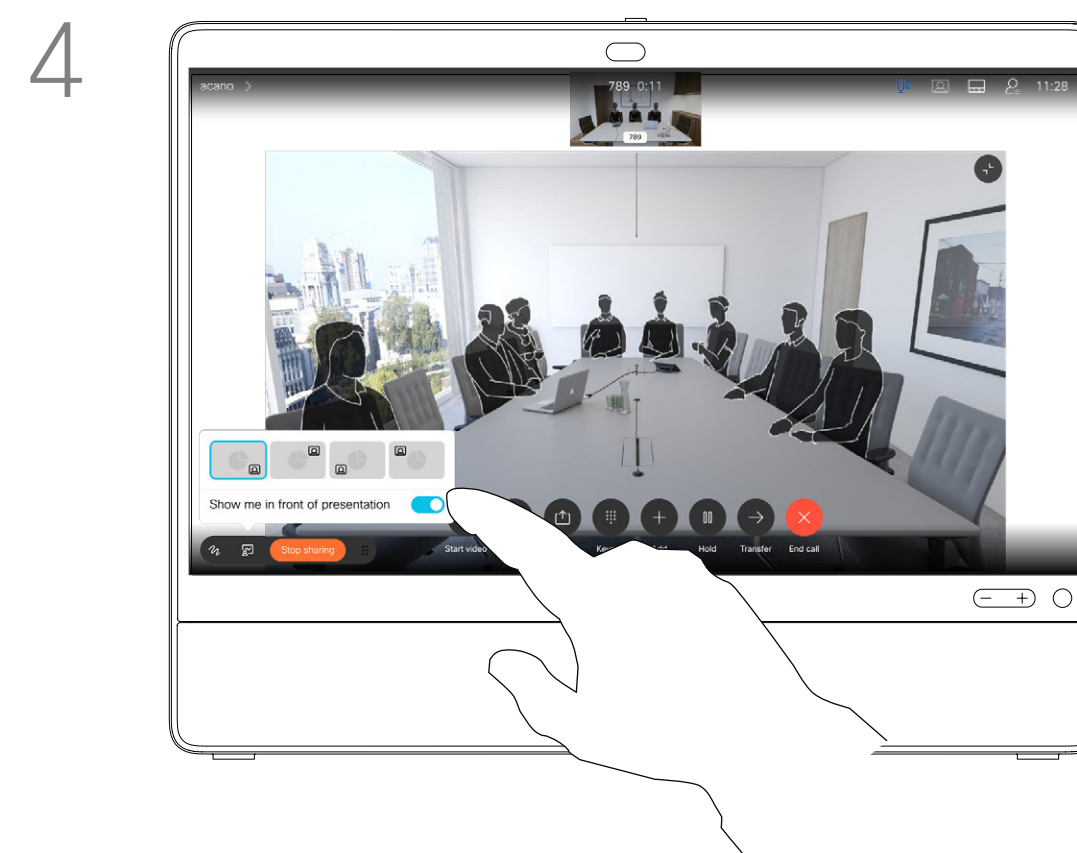

To turn off, tap the **Immersive Share** icon and toggle off **Show me in front of presentation**.

Immersive Share allows for more engaging presentations, where the audience doesn't have to choose whether to focus on the presenter or on the content.

You can now immerse yourself into the content you're sharing, by adding an overlay of your video within the presentation channel. You can change the position of your video on the content, both before and during the share.

Main video is muted when you use Immersive Share, so others don't see your video twice.

You need to enable Virtual Backgrounds before using Immersive Share.

Your computer must be connected to the desk device with the USB-C cable

NOTE: The camera's LED is red while Immersive Share is in use even though the camera is on.

Camera control

Manual camera control

About manual camera control

Your desk device automatically frames you with Best Overview. In some situations, however you want to adjust the framing.
Digital zoom up to 2x.

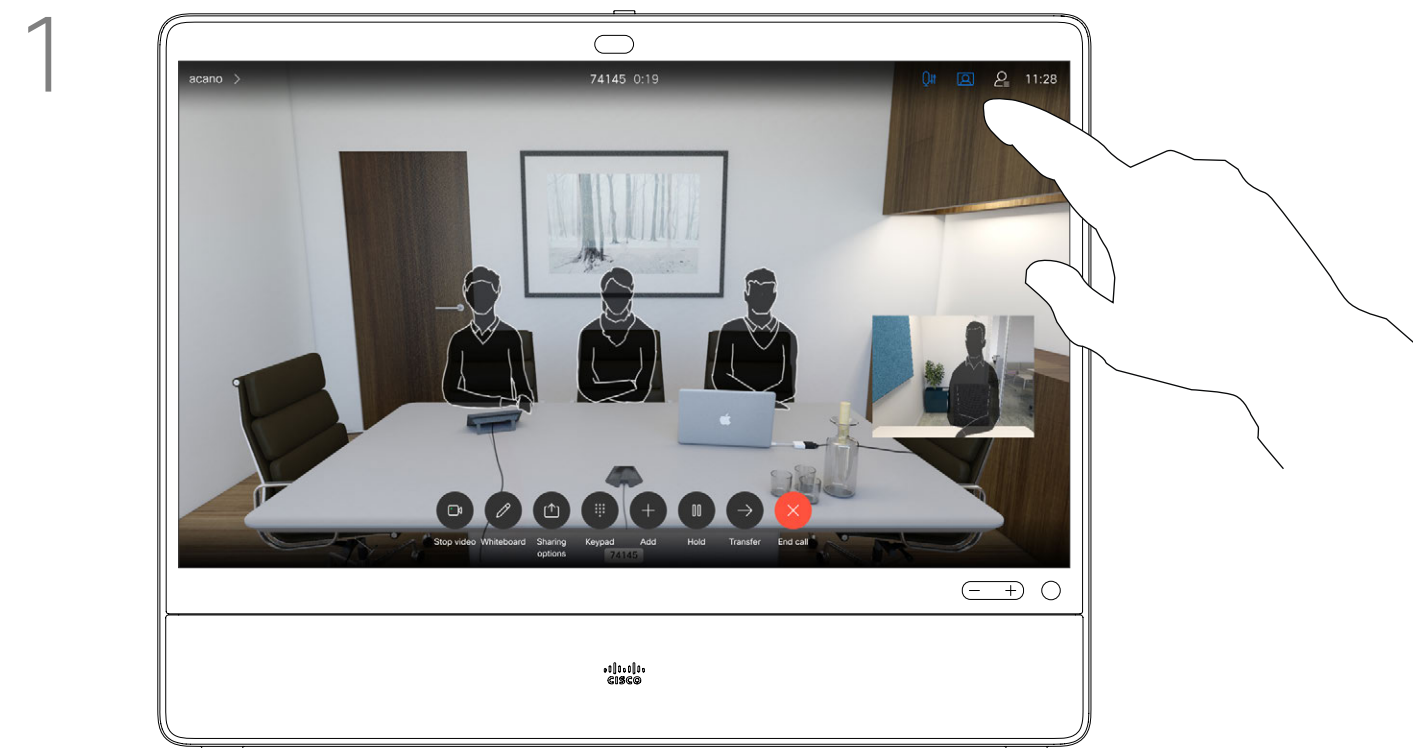

Tap the **Selfview** icon.

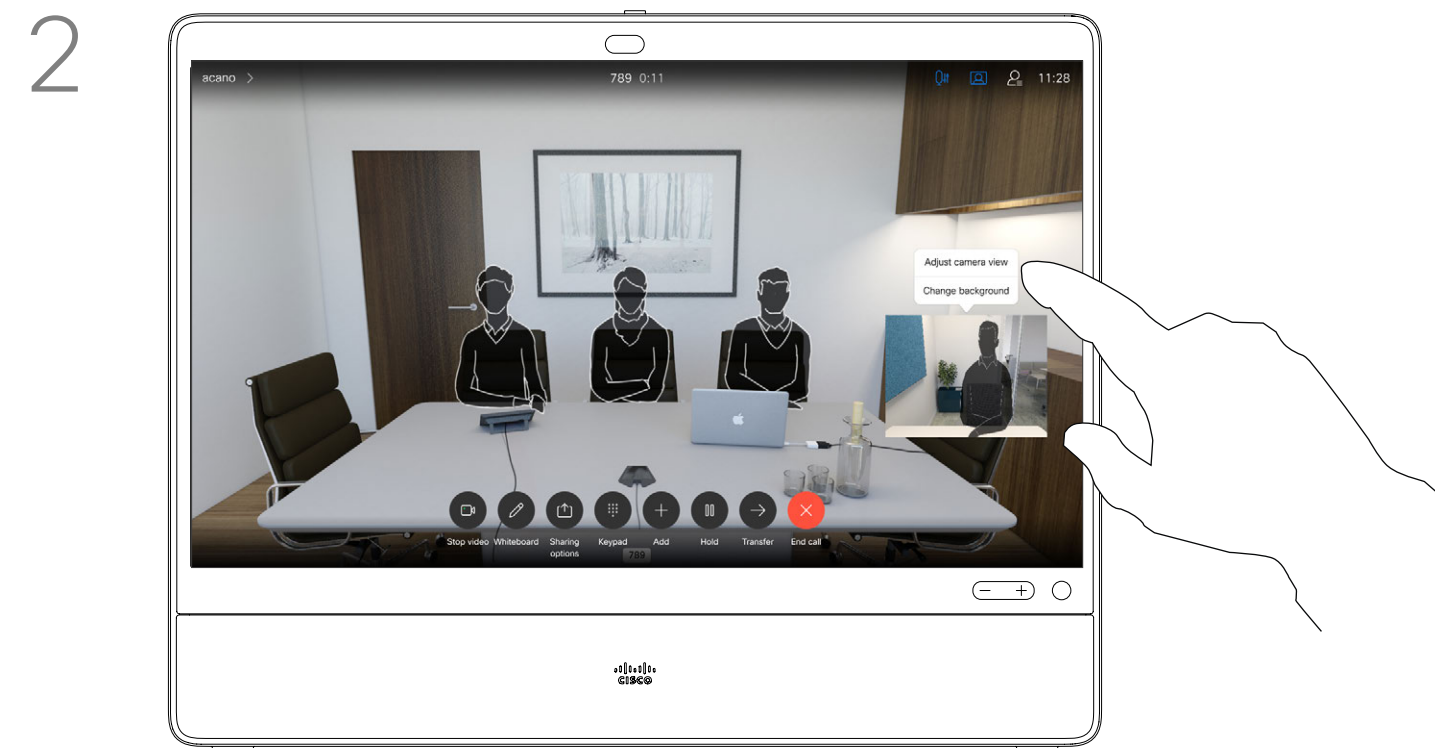

Tap the self-view image and **Adjust camera view** to open the camera options.

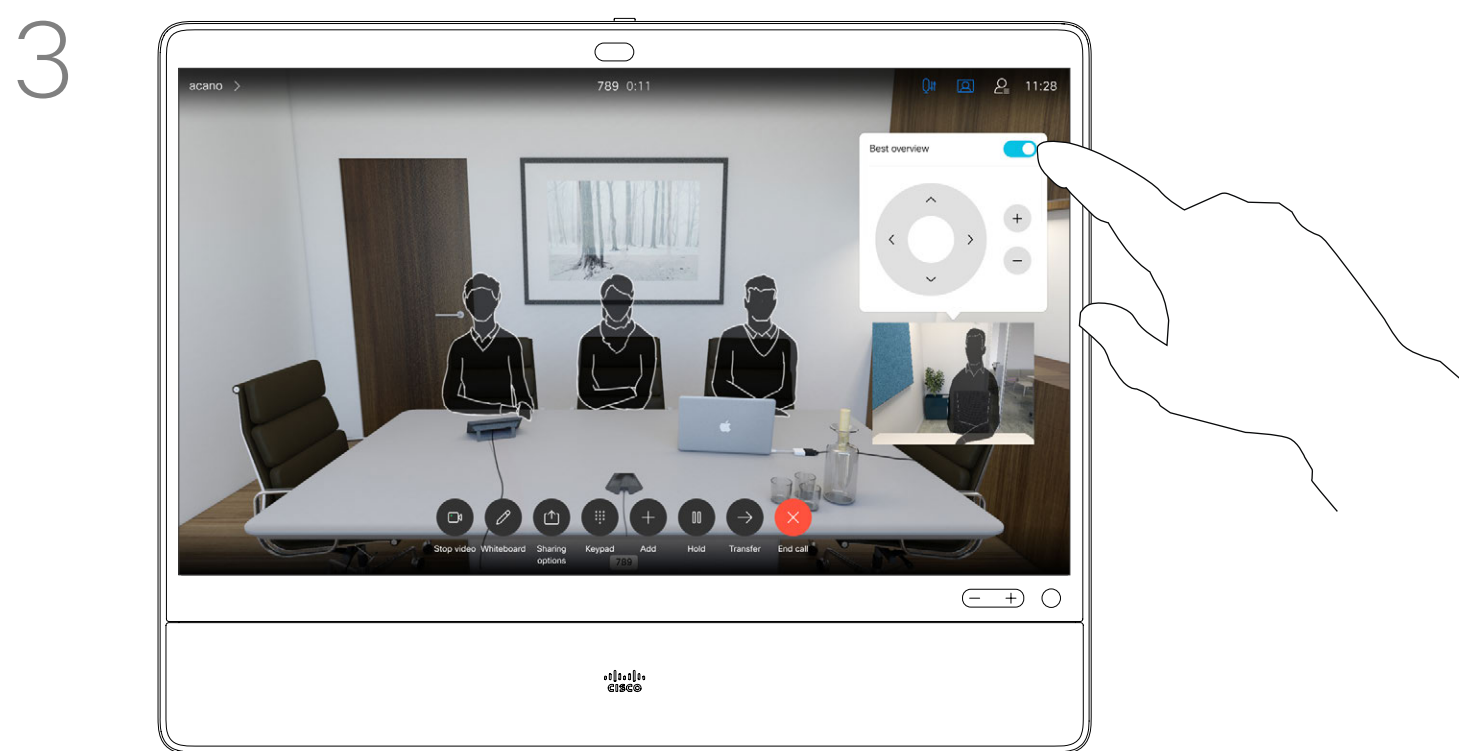

Toggle off **Best Overview**.

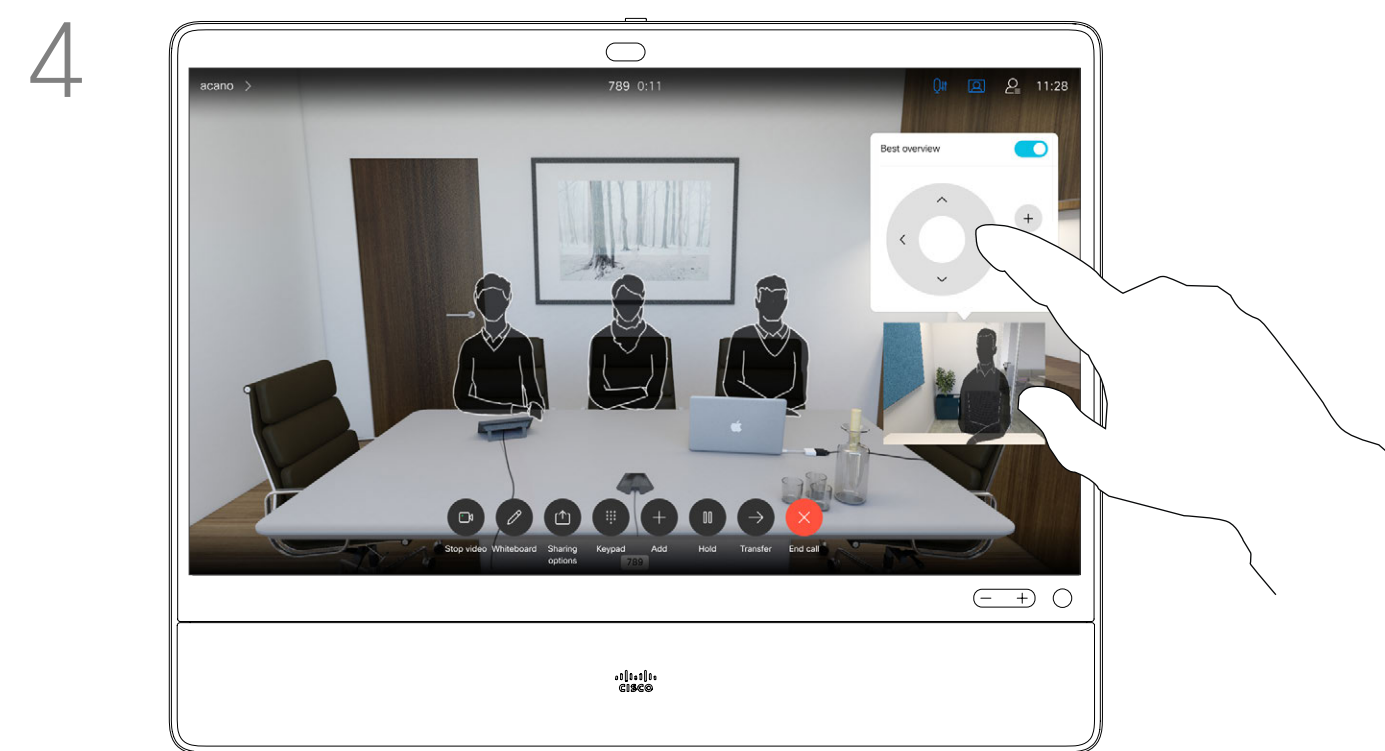

Use the camera controls to adjust pan, tilt, and zoom.
Tap anywhere outside the menu to close it. To close the selfview image, tap the **Selfview** icon.



Settings

Available settings

From the **Settings** menu you can check device information and change several settings. Which settings are available may have been restricted by your administrator.

- Provides video address information, IP and MAC address, SIP Proxy, and the current software version.
- Turn video backgrounds on or off.
- Activate and deactivate Bluetooth.
- Select ringtone and set the volume of the ringtone.
- Choose a call service.
- Select between Wired and Wireless (Wi-Fi) connection.
- Restart the device.
- Perform a Factory Reset to return to factory default settings. By doing this, you lose your current registration. You cannot undo a factory reset.

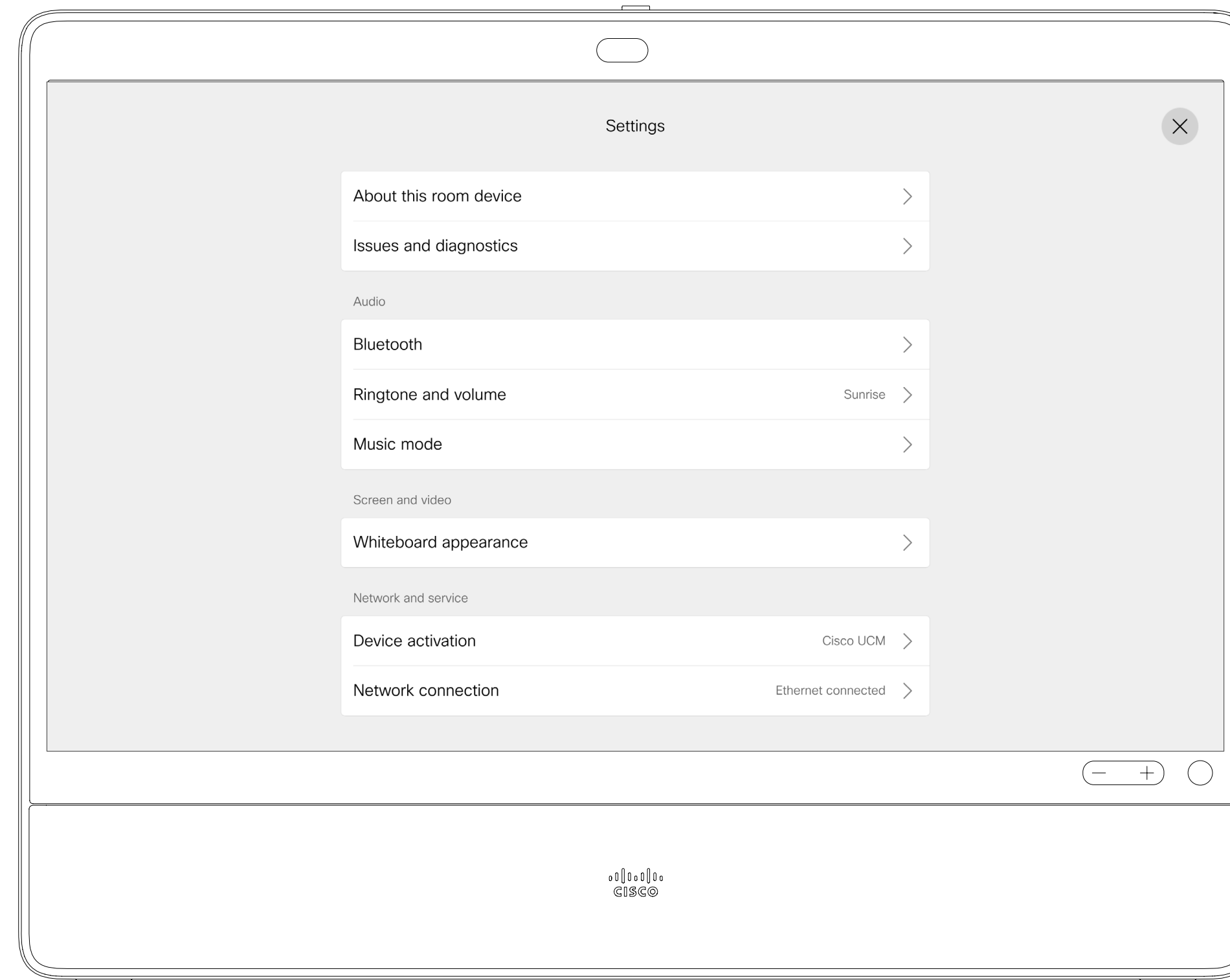

Access settings

To get to Settings, tap the device name in the upper left corner of the home screen. Then tap **Settings**.

