



Cisco Preferred Architecture for Midmarket Collaboration 11.5

Design Overview

June 14, 2016



Contents

- Preface4**
 - Documentation for Cisco Preferred Architectures4
 - About This Guide5
- Introduction6**
 - Technology Use Cases6
 - Architectural Overview7
 - Cisco Business Edition 6000 Medium and High Density Servers.....9
 - Core Applications.....9
 - High Availability10
 - Cisco Integrated Services Router.....10
- Endpoints12**
 - Recommended Deployment.....13
- Call Control14**
 - Recommended Deployment.....15
 - Benefits15
 - Deployment Best Practices15
 - Cisco Unified Communications Manager and IM and Presence Service15
 - Cisco Unified Survivable Remote Site Telephony.....16
 - Dial Plan17
- Conferencing20**
 - Recommended Deployment.....21
 - Audio and Video Conferencing21
 - Benefits21
 - Deployment Best Practices22
 - Audio and Video Instant Conferences22
 - Audio and Video Permanent Conferences.....22
 - Personal Cisco Collaboration Meeting Rooms (CMR) Premises22
 - Scheduled Video Conferences23
 - Cisco WebEx Meetings Server24
 - Cisco WebEx Software as a Service24
 - Cisco Collaboration Meeting Rooms (CMR) Hybrid.....24
 - Collaboration Meeting Rooms Cloud (CMR Cloud)25
 - Cisco TelePresence Management Suite and Extensions.....26
 - Cisco TelePresence Management Suite Provisioning Extension (TMSPE).....26
 - Cisco TelePresence Management Suite Extension for Microsoft Exchange (TMSXE).....26
 - Recommended Deployment27
 - Benefits.....27
 - Support for Multiple Call Processing Sites28
- Collaboration Edge29**
 - Recommended Deployment.....30
 - Headquarters30
 - Remote Sites30
 - Teleworker Sites30



Benefits	30
Deployment Best Practices	30
Cisco Expressway	30
Connectivity for Audio and Video over the Internet.....	32
PSTN Gateway	33
Applications	35
Cisco Unity Connection.....	36
Recommended Deployment	36
Benefits.....	36
Deployment Best Practices.....	36
Cisco Unified Contact Center Express	37
Recommended Deployment	37
Benefits.....	38
Deployment Best Practices.....	38
Cisco TelePresence Content Server	39
Recommended Deployment	39
Redundancy	39
Benefits.....	39
Cisco Prime Collaboration Provisioning Standard.....	40
Recommended Deployment	40
Benefits.....	40
Appendix.....	41
Product List	41
Licensing Options.....	42

Preface

Cisco Preferred Architectures provide recommended deployment models for specific market segments based on common use cases. They incorporate a subset of products from the Cisco Collaboration portfolio that is best suited for the targeted market segment and defined use cases. These deployment models are prescriptive, out-of-the-box, and built to scale with an organization as its business needs change. This prescriptive approach simplifies the integration of multiple system-level components and enables an organization to select the deployment model that best addresses its business needs.

Documentation for Cisco Preferred Architectures

- [Cisco Preferred Architecture \(PA\) Design Overview](#) guides help customers and sales teams select the appropriate architecture based on an organization’s business requirements; understand the products that are used within the architecture; and obtain general design best practices. These guides support pre-sales processes.
- [Preferred Architecture Cisco Validated Design \(CVD\)](#) guides provide details for deploying components within the Cisco Preferred Architectures. These guides support planning, deployment, and implementation (PDI).
- [Preferred Architecture Application Cisco Validated Design \(CVD\)](#) guides provide an optional application solution to the foundational Enterprise Preferred Architecture. These guides support planning, deployment, and implementation (PDI).
- [Cisco Solution Reference Network Design \(SRND\)](#) guide provides detailed design options for Cisco Collaboration. This guide should be referenced when design requirements are outside the scope of Cisco Preferred Architectures.

Figure 1 illustrates how to use the guides. As mentioned, this overview is used for the pre-sales process to explain the products and components, while the CVDs are used in the post-sales process for further design, deployment, and implementation. The set of Application CVDs covers optional applications that can be deployed on top of the foundational Preferred Architecture.

Figure 1 Preferred Architecture Documentation Structure





About This Guide

The Cisco Preferred Architecture for Midmarket Collaboration design overview is for:

- Sales teams that design and sell collaboration solutions
- Customers and sales teams who want to understand the overall collaboration architecture, its components, and general design best practices

Readers of this guide should have a general knowledge of Cisco Voice, Video, and Collaboration products and a basic understanding of how to deploy these products.

This guide simplifies the design and sales process by:

- Recommending products in the Cisco Collaboration portfolio that are built for the midmarket and that provide appropriate feature sets for this market
- Detailing a collaboration architecture and identifying general best practices for deploying in midmarket organizations

For detailed information about configuring, deploying, and implementing this architecture, consult the related CVD documents on the [Design Zone for Collaboration](#).



Introduction

In recent years, many new collaborative tools have been introduced to the market, enabling organizations to extend collaboration outside the walls of their businesses. Providing access to collaborative tools for employees outside the office is no longer a luxury; it is mandatory for businesses to stay relevant in today's market. Today's users expect immediate access to these tools from a wide variety of portable and mobile devices. Many of these same tools can be extended to customers and partners, helping strengthen these relationships.

Organizations realize the added value that collaboration applications bring to their businesses through increased employee productivity and enhanced customer relationships. Not long ago, interoperability among collaboration applications was sparse, and applications were difficult to deploy and use. Since then, significant advances have been made in the collaboration space, simplifying deployment, improving interoperability, and enhancing the overall user experience. Additionally, individuals have adopted a wide variety of smart phones, social media, and collaboration applications in their personal lives.

Organizations can now feel comfortable providing collaboration applications that employees will quickly adopt and that provide maximum value. These new collaboration tools enhance an organization's overall business processes, make its employees more productive, and open the door to new and innovative ways for communicating with business partners and customers. Today's collaboration solutions offer organizations the ability to integrate video, audio, and web participants into a single, unified meeting experience.

Technology Use Cases

Organizations want to streamline their business processes, optimize employee productivity, and enhance relationships with partners and customers. The Cisco Preferred Architecture (PA) for Midmarket Collaboration delivers capabilities that enable organizations to realize immediate gains in productivity and enhanced relationships. Additionally, the following technology use cases offer organizations opportunities to develop new, advanced business processes that deliver even more value in these areas:

- **Consolidate communications infrastructure** — Bring together voice, video, and data into a single IP network to simplify management and support effective communications.
- **Incorporate video into meetings** — Improve communications, relationships, and productivity by making it easier to meet face-to-face over distance.
- **Extend telephony with video** — Facilitate face-to-face video communications directly from end-user phones or softphone applications.
- **Support teleworkers and branch offices** — Let employees work from multiple locations, whether satellite offices, home offices, or when traveling.
- **Collaborate with external organizations** — Easily share information, interact in real time, and communicate using technologies beyond email and telephone.
- **Create flexible work areas and office spaces** — Scale office space and create work areas that foster employee inclusiveness, collaboration, innovation, and teamwork.
- **Deploy a Unified Communications architecture** — Provide the entire global organization with a single communications tool set for all users.

Information about Cisco Collaboration Technologies and use cases is available on [Cisco.com](https://www.cisco.com).

Architectural Overview

The Cisco PA for Midmarket Collaboration provides end-to-end collaboration targeted for deployments of up to 1,000 users. This architecture provides high availability for critical applications and incorporates products developed and priced for the midmarket. The consistent user experience provided by the overall architecture facilitates quick user adoption, enabling an organization to recognize immediate value for its investment. Additionally, the architecture supports an advanced set of collaboration services that extend to mobile workers, partners, and customers through the following key services:

- Voice communications
- Instant messaging and presence
- High-definition video and content sharing
- Rich media conferencing
- Recording of video and conferences
- Enablement of mobile and remote workers
- Business-to-business voice and video communications
- Unified voice messaging
- Customer care

Because of the adaptable nature of Cisco endpoints and their support for IP networks, this architecture enables an organization to use its current data network to support both voice and video calls. In general, it is a best practice to deploy a collaboration solution with proper quality of service (QoS) configured throughout the network. Voice and video IP traffic should be classified and prioritized to preserve the user experience and avoid negative effects such as delay, loss, and jitter. For more information about LAN and WAN QoS, see the [Cisco Collaboration SRND](#).

The Cisco PA for Midmarket Collaboration, shown in [Figure 2](#), provides highly available and secure centralized services. These services extend easily to remote offices and mobile workers, providing availability of critical services even if communication to headquarters is lost. Centralized services also simplify management and administration of an organization's collaboration deployment.

Figure 2 Cisco Preferred Architecture for Midmarket Collaboration

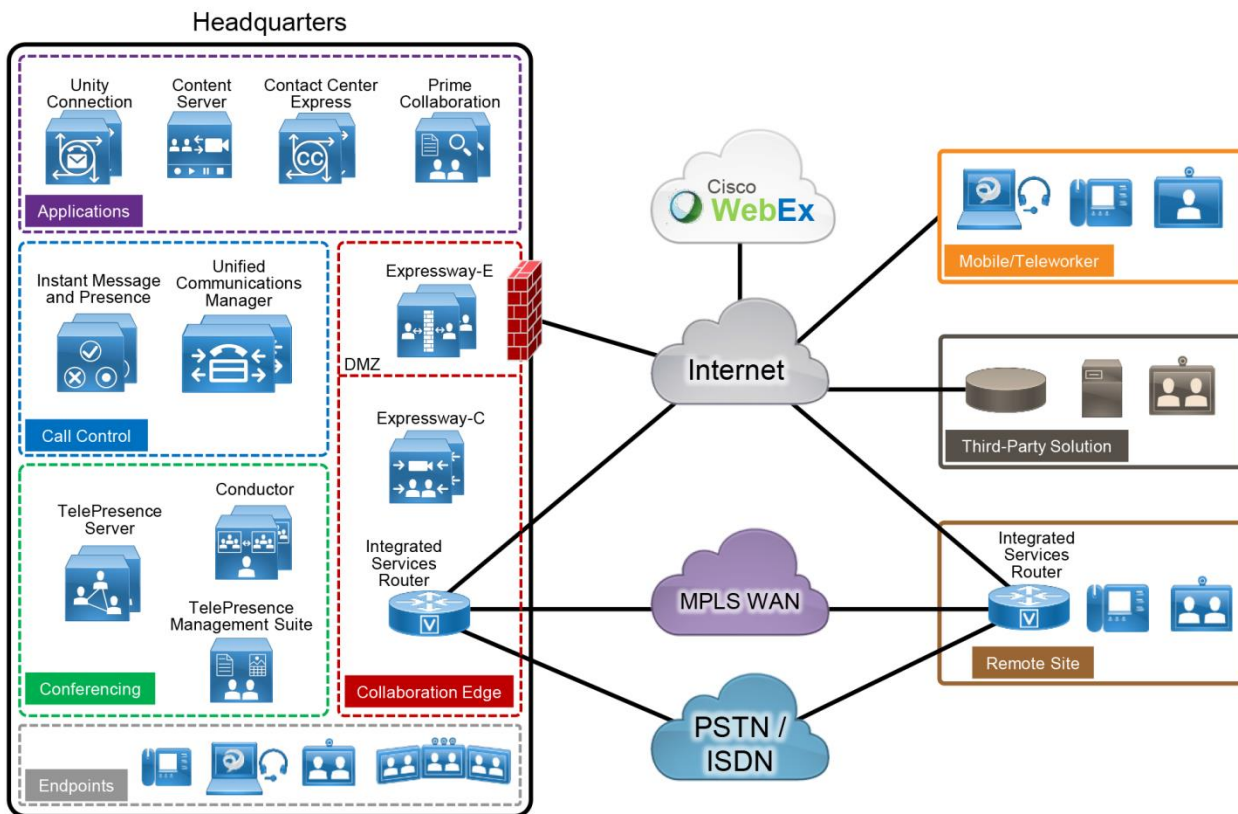

Table 1 lists the products in this architecture. For simplicity, products are grouped into modules to help categorize and define their roles. The content in this guide is organized in the same modules.

Table 1 Components for the Cisco Preferred Architecture for Midmarket Collaboration

Module	Component	Description
Call Control	Cisco Unified Communications Manager (Unified CM)	Provides endpoint registration, call processing, and media resource management
	Cisco Unified Communications Manager IM and Presence Service	Provides instant messaging and presence services
	Cisco Integrated Services Router (ISR)	Provides Survivable Remote Site Telephony (SRST) functionality
Endpoints	Cisco IP Phones, Cisco TelePresence video endpoints, and Cisco Jabber	Enable real-time voice, video, and instant messaging communications for users
Conferencing	Cisco TelePresence Conductor	Manages conferencing resources
	Cisco TelePresence Server	Provides video conferencing resources
	Cisco WebEx Software as a Service (SaaS)	Provides subscription-based web conferencing delivered through WebEx Collaboration Cloud
	Cisco TelePresence Management Suite (TMS) and Extensions	Provides scheduling, web conferencing integration, and other advanced video features
Collaboration Edge	Cisco Expressway-C	Enables interoperability with third-party systems and firewall traversal
	Cisco Expressway-E	Supports remote endpoint registration to Cisco Unified CM and enables business-to-business communications
	Cisco ISR	Provides either public switched telephone network (PSTN) or Cisco Unified Border Element (CUBE) connectivity

Module	Component	Description
Applications	Cisco Unity Connection	Provides unified messaging and voicemail services
	Cisco Unified Contact Center Express (Unified CCX)	Provides customer interaction management services
	Cisco Prime Collaboration Provisioning Standard	Provides administrative functions (provisioning) for Cisco Unified Communications applications
	Cisco TelePresence Content Server	Provides video and conference recording

Cisco Business Edition 6000 Medium and High Density Servers

Cisco Business Edition (BE) 6000M and 6000H are packaged systems designed specifically for organizations with up to 1,000 users, and they are the foundation of this architecture. The Cisco BE6000M and BE6000H are built on a virtualized Cisco Unified Computing System (UCS) that is prepared and ready for use, with a preinstalled virtualization hypervisor and application installation files. The Cisco BE6000M or BE6000H solution offers premium voice, video, messaging, instant messaging and presence, and contact center features on a single, integrated platform. For these reasons the BE6000M and BE6000H are ideal platforms for the Cisco PA for Midmarket Collaboration. For more information about the Cisco BE6000M and BE6000H, consult the [data sheet](#).

Core Applications

The Cisco PA for Midmarket Collaboration is built on two Cisco BE6000 high-density servers to provide high availability for applications within the architecture (Figure 3). Virtualizing multiple applications on a single server lowers cost, minimizes rack space, lowers power requirements, and simplifies deployment and management. Virtualization also accommodates redeploying hardware and scaling software applications as organizational needs change.

Figure 3 Cisco Preferred Architecture for Midmarket Collaboration Deployed on Cisco BE6000H

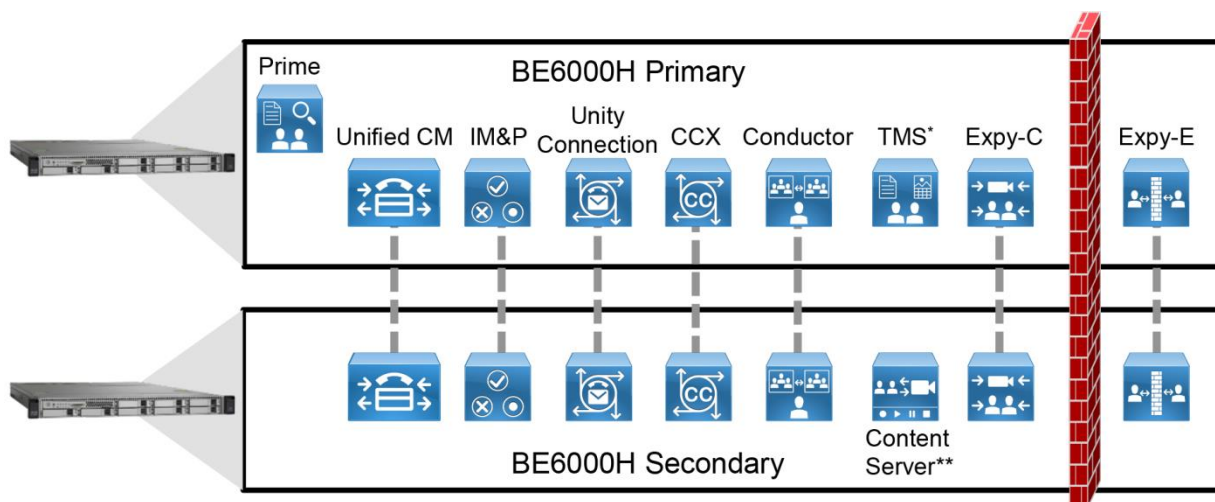

*The TMS node includes TMS, TMSPE, TMSXE, and an embedded SQL server.

**The TelePresence Content Server is installed on a virtualized Windows server.

In this architecture, the following applications and Cisco Prime Collaboration Provisioning Standard are deployed on one Cisco BE6000H server, while a second instance of most applications is deployed on a second Cisco BE6000H server, providing hardware and software redundancy for:

- Cisco Unified Communications Manager
- Cisco Unified Communications Manager IM and Presence Service
- Cisco Unity Connection
- Cisco Expressway, consisting of Expressway-C and Expressway-E
- Cisco TelePresence Conductor
- Cisco Unified Contact Center Express

We recommend always deploying redundant configurations to provide the highest availability for critical business applications; however, a non-redundant Cisco BE6000M and/or BE6000H server configuration may be deployed for organizations that do not require full redundancy.

High Availability

The Cisco PA for Midmarket Collaboration provides high availability for all deployed applications by means of the underlying clustering mechanism present in all Cisco Unified Communications applications.

Clustering replicates the administration and configuration of deployed applications to backup instances of those applications. If an instance of an application fails, Cisco Unified Communications services — such as endpoint registration, call processing, messaging, business-to-business communication, and many others — continue to operate on the remaining instance(s) of the application. This failover process is transparent to the users. In addition to clustering, the Cisco PA for Midmarket Collaboration provides high availability through the use of redundant power supplies, network connectivity, and disk arrays.

The one exception to this is the Cisco TelePresence Management Suite (TMS) and TelePresence Content Server solution of applications. In order for TMS to be fully redundant, an external SQL database is required as well as the Large Deployment of TMS, TelePresence Management Suite Provisioning Extension (TMSPE), and TelePresence Management Suite Extension for Microsoft Exchange (TMSXE). To keep costs low for midmarket customers, we recommend deploying a single instance of the TMS solution with an embedded SQL server.

The TelePresence Content Server currently does not support redundancy on the BE6000M or BE6000H.

Cisco Integrated Services Router

Cisco Integrated Services Routers (ISRs) provides Wide Area Network (WAN) and Cisco Unified Communications services in a single platform. In the Cisco PA for Midmarket Collaboration, the Cisco ISR and ASR can provide the following functions ([Figure 4](#)):

- Media resources (MTP and transcoder) for Cisco Unified Communications Manager
- External connectivity to the Internet
- IP routing and network services such as DHCP, DNS, NTP, and others
- Cisco Unified Survivable Remote Site Telephony (SRST) to support calls during WAN failures
- Voice gateway to the Public Switched Telephone Network (PSTN) or Cisco Unified Border Element (CUBE) for Session Initiation Protocol (SIP) trunks
- Integrated data and voice connectivity to service providers
- Multiprotocol Label Switching (MPLS) WAN connectivity for an organization's network

Figure 4 Cisco ISR Functions

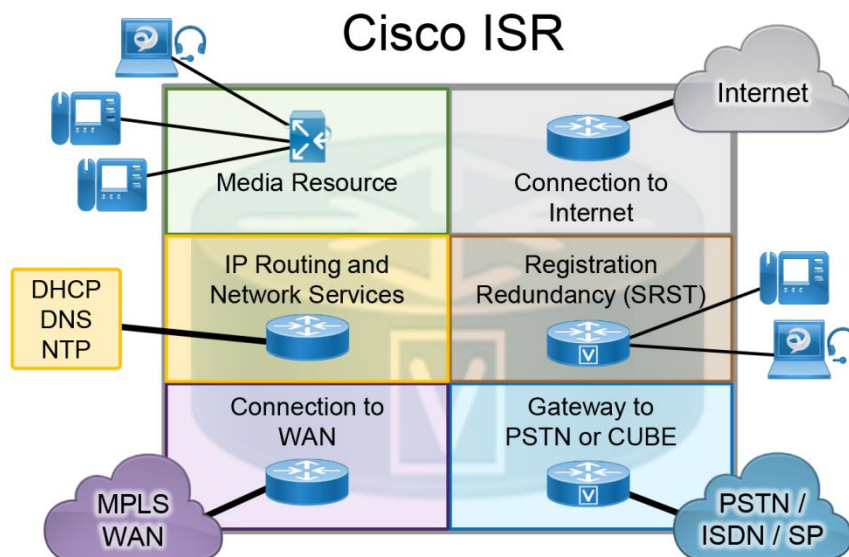

The Cisco ISR has additional slots that support add-on modules such as wireless controllers and VMware ESXi servers. Deployments can use various Cisco ISR models to support different features, to scale, and to accommodate additional services. The modular design enables the Cisco ISR to be deployed at headquarters, remote locations, or branch locations. For more information about the various Cisco ISR models, see the [product documentation](#).

Endpoints

Cisco Collaboration endpoints provide a wide range of features, functionality, and user experiences. Cisco endpoints range from low-cost, single-line phones and soft clients to three-screen Cisco TelePresence endpoints, allowing an organization to deploy the right variety of endpoints to meet users' needs (Figure 5). Additionally, these devices enable users to access multiple communication services such as:

- Voice calls
- Video calls
- Conferencing
- Voicemail
- Presence
- Instant messages (Cisco Jabber)
- Desktop sharing

Figure 5 Architecture for Endpoints

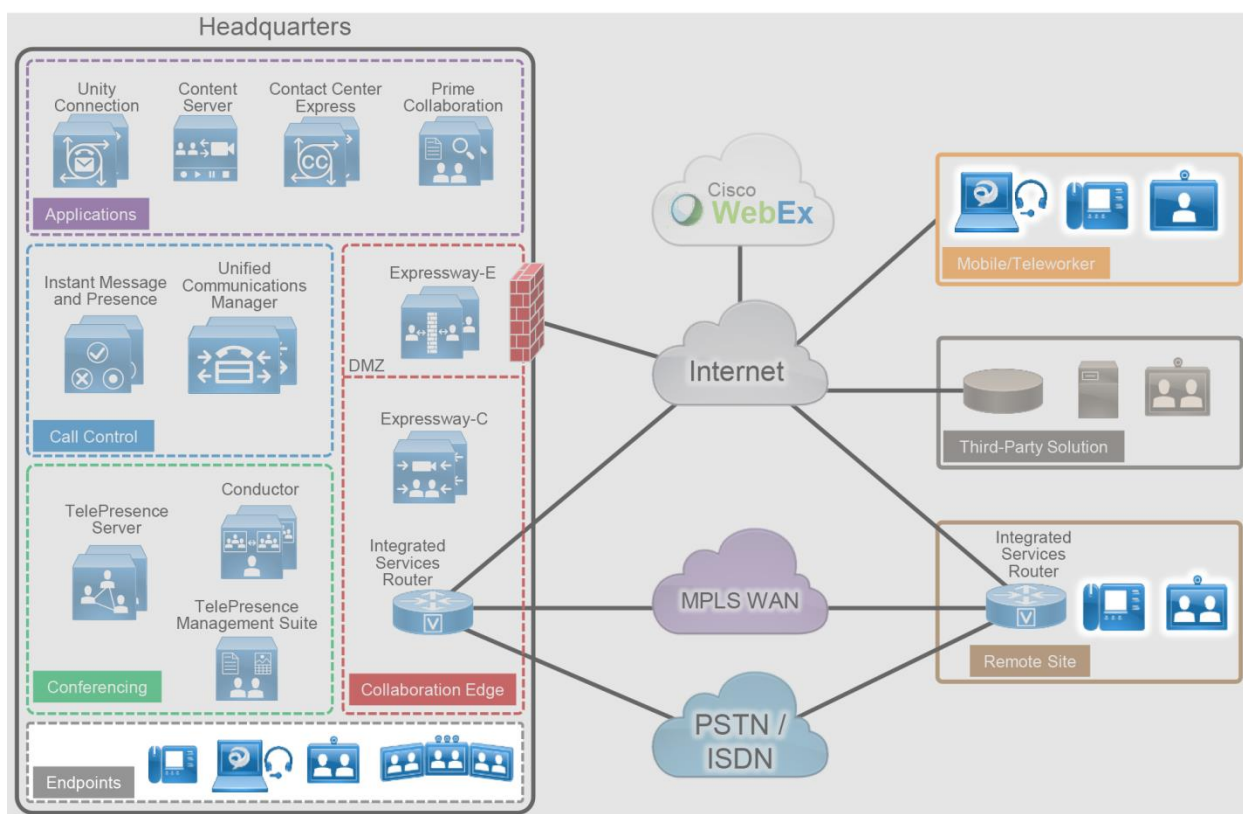

Recommended Deployment

Cisco Unified CM is the call control server for the Cisco PA for Midmarket Collaboration. Cisco IP Phones, Jabber clients, and TelePresence video endpoints use SIP to register directly to Cisco Unified CM. The Unified CM cluster's failover mechanism provides endpoint registration redundancy. If a WAN failure occurs and endpoints at remote locations cannot register to Unified CM, they use SRST functionality for local and PSTN calls, but some services such as voicemail and presence might not be available.

We recommend the endpoints listed in the following tables because they provide optimal features for this design. Cisco has a [range of endpoints](#) with various features and functionality that an organization can also use to address its business needs.

Table 2 Cisco IP Phones

Product	Description
Cisco IP Phone 7811	Public space, single-line phone
Cisco IP Phone 8800 Series	General office use, multiple-line phone
Cisco Unified IP Conference Phone 8831	IP conference phone

Table 3 Cisco TelePresence and Video Endpoints

Product	Description
Cisco DX Series	Personal TelePresence endpoint for the desktop
Cisco MX Series	TelePresence multipurpose room endpoint
Cisco SX Series	Integrator series TelePresence endpoint

Table 4 Cisco Jabber

Product	Description
Mobile: Jabber for Android Jabber for iPhone and iPad	Soft client with integrated voice, video, voicemail, instant messaging, and presence functionality for mobile devices and personal computers
Desktop: Jabber for Mac Jabber for Windows	

Table 5 Comparison of Endpoint Features and Capabilities

Product(s)	Audio	Video	Content Sharing	Unified CM High Availability	Mobile and Remote Access	Video SRST	Audio SRST
IP Phone 7811	Y	N	N	Y	Y	N	Y
IP Phone 8845 and 8865	Y	Y	N	Y	N	N	Y
IP Phone 8800 Series	Y	N	N	Y	N	N	Y
IP Conference Phone 8831	Y	N	N	Y	N	N	Y
DX Series	Y	Y	Y ¹	Y	N	N	N
MX Series	Y	Y	Y	Y	Y	N	N
SX Series	Y	Y	Y	Y	Y	N	N
Jabber Mobile	Y	Y	N	Y	Y	N	N
Jabber Desktop	Y	Y	Y	Y	Y	Y	Y

1. The Cisco DX70 and DX80 are the only DX Series endpoints that support content sharing

Call Control

Call control is the core element for any communications deployment. It provides endpoint registration, call processing, and call admission control. Call control design considerations include the enterprise dial plan, endpoint addressing scheme, calling party presentation, call admission control, codec selection, PSTN connectivity, and general trunking requirements, as well as other factors.

Cisco Unified CM provides a common call control platform for all Cisco Collaboration deployments (Figure 6). Having a highly available and common call control component for a communications infrastructure is crucial to provide consistent services for all devices and communication types and to preserve a uniform dial plan and a consistent feature set across the enterprise.

Adding the IM and Presence Service to a Cisco Unified CM deployment provides instant messaging, network-based presence, and federation for third-party chat servers, and it enables the use of Cisco Jabber for instant messaging, presence, and audio and video communications.

Figure 6 Architecture for Call Control

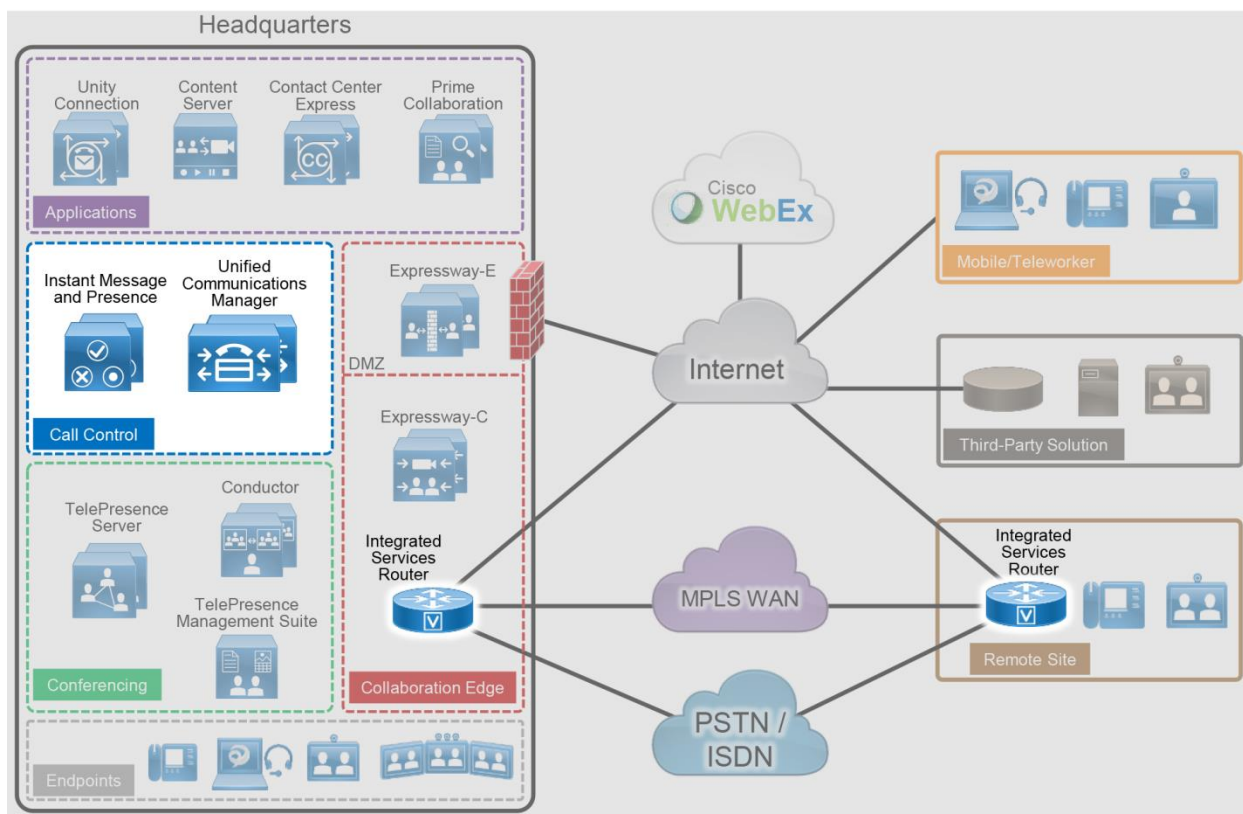

Table 6 lists the roles of the call control components in this architecture and the services they provide.

Table 6 Components for Call Control

Module	Component	Description
Call Control	Cisco Unified Communications Manager (Unified CM)	Provides call routing and services, dial plan, and bandwidth management; and enables Cisco Jabber desk phone control
	Cisco Unified Communications Manager IM and Presence Service	Provides Cisco Jabber support for instant messaging and user-based presence and third-party federation
	Cisco Integrated Services Router (ISR)	Provides Survivable Remote Site Telephony (SRST) to support call control functions during a WAN outage

Recommended Deployment

- Deploy two Cisco Unified CM servers in a cluster configuration that includes a publisher node and a subscriber node for redundancy.
- Deploy two IM and Presence Service servers in a cluster configuration that includes a publisher node and a subscriber node for redundancy.
- Enable Cisco SRST on the Cisco ISR as a backup service at remote sites to provide high availability.

Note: If full redundancy is not required, a single server may be deployed without loss of functionality.

Benefits

This deployment provides the following benefits:

- Call control is centralized at a single location that serves multiple remote sites.
- Management and administration are centralized.
- Common telephony features are available across voice and video endpoints.
- Single call control and a unified dial plan are provided for voice and video endpoints.
- Critical business applications are highly available and redundant.

Deployment Best Practices

Cisco Unified Communications Manager and IM and Presence Service

Publisher-Subscriber Deployment Model

A Cisco Unified CM cluster or an IM and Presence Service cluster consists of one publisher node and one subscriber node (Figure 7).

- The publisher node is the server that is installed first. This server contains the cluster's configuration database. Cluster-wide configuration is written to the publisher's database and replicated on the subscriber.
- The subscriber node is the server that is installed second. It contains a replica of the publisher's database. The subscriber is updated automatically whenever the publisher's configuration changes.

Clustering provides an automatic redundancy mechanism for endpoints and for Cisco Unified CM services, such as the ability to receive and process incoming calls. We recommend configuring the Unified CM cluster with the subscriber node as the primary call-processing server and the publisher node as the backup call-processing server. This configuration applies to the IM and Presence Service cluster, too. If the IM and Presence Service subscriber node goes down, then IM and presence capabilities will still be available for Cisco Jabber clients.

Figure 7 Cisco Unified CM Cluster

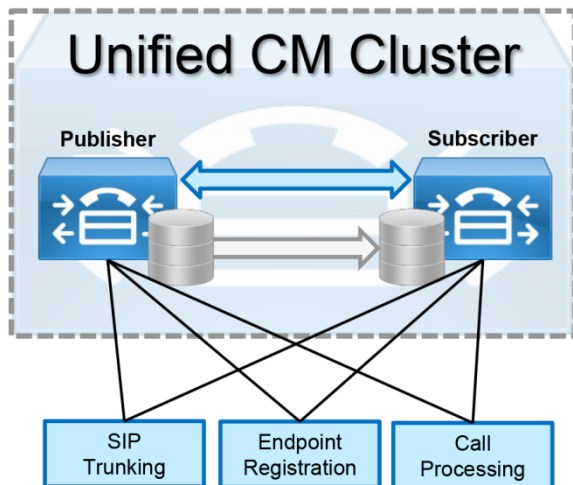

SIP Trunk Recommendations

Use SIP trunks from Cisco Unified CM to communicate with all the components in the Cisco PA for Midmarket Collaboration, including external entities such as third-party systems. SIP trunks offer the following benefits:

- SIP trunks provide a standards-based environment that reduces operations and maintenance complexity of the end-to-end solution.
- SIP trunks are enhanced with presence information.
- SIP trunks are recommended for video communications.

Configure a SIP trunk from the Cisco Unified CM cluster to external components in the deployment, such as TelePresence Conductor and the IM and Presence Service. Specify each server for the external component as a destination in the SIP trunk configuration. This configuration provides continuation of services if a node goes down.

Cisco Unified Survivable Remote Site Telephony

The Cisco Survivable Remote Site Telephony (SRST) feature is critical for remote sites that require continuation of voice services during WAN outages. SRST runs on the same Cisco ISR that provides WAN and PSTN connectivity for the remote site.

Deploy SRST on the Cisco ISR in the following cases:

- The remote site has local PSTN connectivity.
- The remote site does not have local PSTN connectivity but has more than 25 users.

To avoid interruption of external voice services if a WAN outage occurs, provide local PSTN connectivity at the remote site. SRST is required only if the remote site's WAN reliability does not match that site's required service level for voice service availability.

If a WAN failure occurs at a site with SRST and local PSTN access, the following services will be available:

- Internal point-to-point voice calls and video calls (with enhanced SRST only)
- External voice calls through the PSTN
- Call hold, transfer, and conference
- Music on hold

Note: SRST is not available for Cisco MX or SX Series endpoints. See the [SRST data sheet](#) for information about endpoints that support SRST.

Dial Plan

A structured, well-designed dial plan is essential to successful deployment of any call control system. When designing a dial plan, consider the following main factors:

- Dialing habits
- Endpoint addressing
- Routing
- Directory integration
- Classes of service

Dialing Habits

Dialing habits describe what end users can dial to reach various types of destinations. Dialing habits can first be classified as numeric dialing (for example, 914085550123) or alphanumeric dialing (for example, bob@ent-pa.com).

Typically, different types of destinations require support for different dialing habits. For example:

- PSTN toll call: for example, in North America, 91-<10 digits>
- PSTN international call: for example, in North America, 9011-<country code + national significant number>
- Abbreviated intra-site dialing: for example, 4XXX
- Abbreviated inter-site dialing: for example, 8-<site code>-<intra-site number>
- +-dialing from directories: "+" followed by a fully qualified global PSTN number as described in ITU recommendation E.164
- URI dialing: for example, bob@ent-pa.com for intra-company and inter-company dialing. Endpoints typically allow omission of the right-hand side (host portion) of the URI and they automatically append the local host portion, so that bob@ent-pa.com can also be abbreviated as bob.

Further dialing habits might have to be defined for services such as call pick-up, voicemail, and others. Also, future growth should be considered so that more users and more sites can be added as needed without redesigning the dial plan.

Some dialing habits, typically PSTN dialing habits in particular, need to follow country-specific requirements or established dialing procedures. For example, in contrast to the trunk access code 9 in the above US-based examples, 0 is used for trunk access in many other countries. The dialing habit for national calls in these cases, in addition to the potential for using 0 as the trunk access code, also needs to reflect the characteristics of the national numbering plan of the respective country.

Identifying dialing habits is most important when defining an enterprise dial plan in order to avoid overlaps between any two dialing habits. For example, a trunk access code of 9 prohibits abbreviated intra-site dialing starting with 9. Avoiding overlaps between dialing habits is crucial to avoid inter-digit timeouts, which lead to bad user experiences.

In migration scenarios, the dialing habits supported by the existing system can be used as a first estimate of the dialing habits required in the new system. On the other hand, migration to a new communications system can also serve as a reason to get rid of outdated customs and practices.

Endpoint Addressing

Each endpoint registered with the enterprise call control must have a unique numeric address. Endpoint addresses in Cisco Unified CM are equivalent to the directory numbers provisioned on the lines of the endpoints. Use fully qualified PSTN numbers (E.164 numbers) with a leading “+” as endpoint addresses. This format is typically referred to as +E.164 format. The benefits of using +E.164 endpoint addresses include:

- Wide use in voice networks
- No need to develop and maintain an enterprise numbering scheme
- Easy creation of correct caller ID presentation for all on-cluster and off-cluster call flows
- Easy implementation of directory lookups
- Simplified alternate routing to the PSTN in cases of WAN failure or bandwidth constraints

For endpoints without assigned PSTN-based direct inward dial (DID) numbers (no E.164 number representation exists), create enterprise-wide unique endpoint addresses outside of the default +E.164 domain. These endpoint addresses should be in line with the internal dialing habit defined to reach these endpoints. If, for example, the abbreviated inter-site dialing habit to reach a set of non-DID endpoints in a given site is 84915XXX, then these non-DID endpoints should use this numbering scheme for their endpoint addresses.

In addition to the primary numeric endpoint addresses, administrators can provision alphanumeric URIs (for example, bob@ent-pa.com) in Cisco Unified CM to serve as aliases for the primary addresses, and users can enter the URI as an alternate way to dial the destination endpoint.

Routing

The routing portion of the dial plan enables users to reach the correct destinations when they use the defined dialing habits.

The primary numeric routing is based on +E.164 numbers. External routes to other transport networks such as the PSTN also use the +E.164 scheme. Endpoint addresses in +E.164 format provide +E.164 on-net dialing without any further configuration. All other numeric dialing habits, such as abbreviated inter-site and intra-site dialing, are implemented as overlays by adding the appropriate translation patterns to the dial plan to map from the implemented dialing habit to the +E.164 global routing address format. This allows users to reach the same endpoint by means of different dialing habits, depending on user preference.

Alpha-numeric URIs, as aliases for numeric addresses, provide an alternative means of reaching endpoints. The benefits of URI dialing and routing include:

- Conformity with the native dialing habit on most video systems
- Easier business-to-business connectivity
- Direct mapping from instant messaging identifiers to addresses (easier escalation of business-to-business IM sessions to voice and/or video), although technically IM identifiers and SIP URIs are not necessarily identical

If an endpoint is enabled for business-to-business calls over the Internet, we recommend associating a SIP URI to the device so that the business-to-business routing logic can be based on SIP URIs.

As with numeric routing, if an alias or SIP URI is recognized as an internal destination and is associated with a specific device, then Cisco Unified CM sends the call to that device. However, if the dialed SIP URI does not match any registered endpoint alias, Cisco Unified CM uses SIP route patterns to determine where to send the call. For example, if the dialed alias room1@example.com does not exist internally, Cisco Unified CM uses a SIP route pattern (such as *.com) to send the call to Expressway-C as a business-to-business call.

Directory Integration

To enable users to search contacts and dial from the directory, integrate Cisco Unified CM with the organization's LDAP directory. Although Cisco Unified CM allows the creation of local user contacts, LDAP directory integration is required when using Cisco Jabber because it provides a single location for directory management and enables users to authenticate to Cisco Unified CM and Cisco Jabber by using their LDAP directory credentials.

Cisco Unified CM pulls user and contact information from LDAP directories and synchronizes user parameters — name, surname, username, telephone number, and SIP URI — when changes occur. For example, use the **telephoneNumber** attribute to populate the Telephone Number field in the Cisco Unified CM directory. The format of phone numbers in the corporate directory must be globally significant and must match one of the defined dialing habits. Corporate directories typically should have all phone numbers in +E.164 format (leading "+" followed by the fully qualified global number) as long as a DID exists. Only this format allows the phone number in the corporate directory to be used universally inside and outside the enterprise. Non-DID numbers that are not in +E.164 format could be used to dial uses internally from the directory, but they would have no significance outside the enterprise. Use the **mail** attribute to populate the Directory URI field in the Cisco Unified CM directory if URI dialing is used.

The IM and Presence Service pulls user and contact information from Cisco Unified CM.

Class of Service

Class of service defines which users can access which services, such as allowing only emergency and local calls from lobby phones while allowing unrestricted calls from executive phones. The complexity of the dial plan is directly related to the number of differentiated classes of service it supports.

To define classes of service, configure partitions and calling search spaces in Cisco Unified CM. The number of classes of service supported by a dial plan depends on the granularity and complexity of the classes. For more information about classes of service and details on enterprise dial plan design, see the [Cisco Collaboration SRND](#).

Conferencing

The ability for three or more people to communicate in real time by using voice and video technologies is a core component of collaboration. Cisco rich media conferencing builds upon existing infrastructure in place for point-to-point calls, offering users a consistent voice and video experience (Figure 8).

Figure 8 Architecture for Conferencing

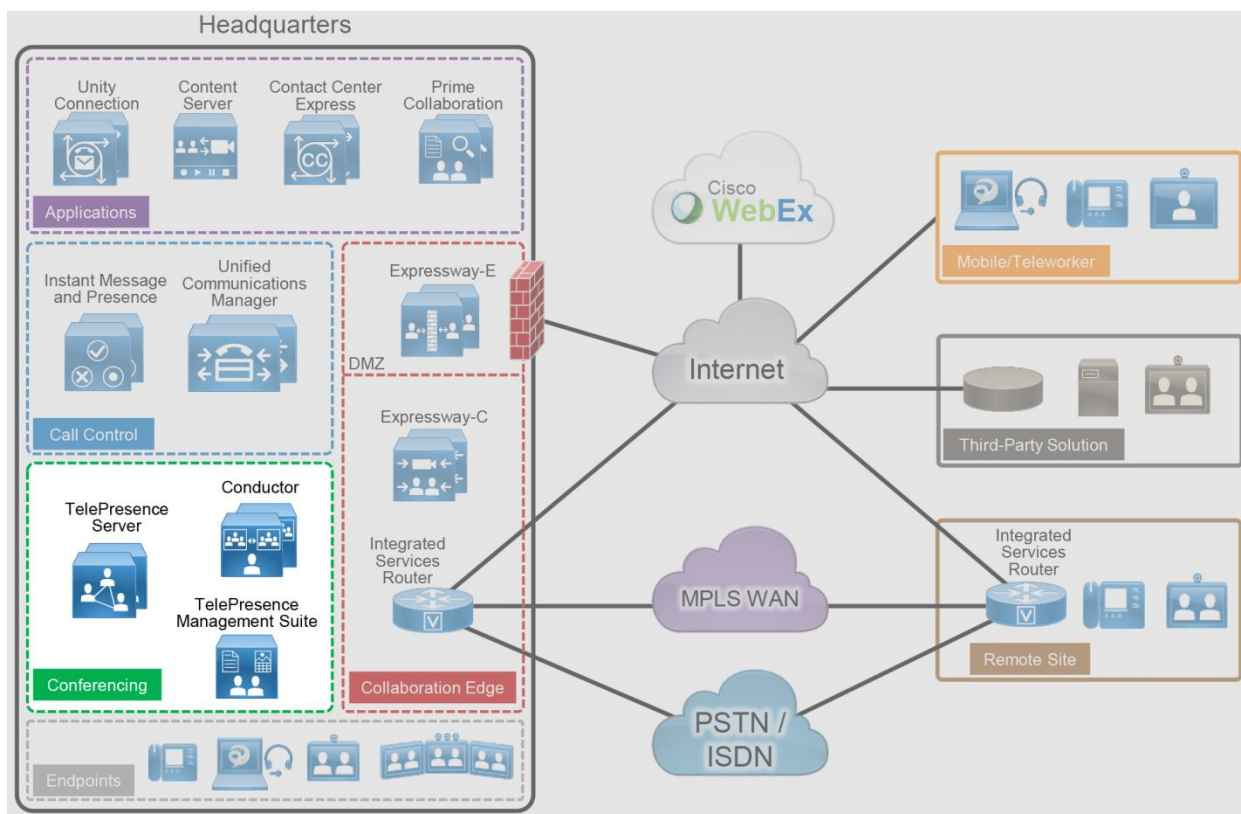

Table 7 lists the roles of the conferencing components in this architecture and the services they provide.

Table 7 Components for Conferencing

Module	Component	Description
Conferencing	Cisco TelePresence Conductor	Manages and allocates conferencing resources requested from Unified CM. Optimizes resources by making unused resources available for greater scalability in conferencing. Conference templates can be created on the TelePresence Conductor for differentiating conferences based on quality, multiscreen support, cascade inks, number of participants, conference duration, content quality, and so forth.
	Cisco TelePresence Server	Provides voice and video conferencing. Available on dedicated hardware platforms and on virtual machines. Deployed concurrently with Cisco TelePresence Conductor (remotely managed mode). Note: Cisco TelePresence Server 4.3 and later releases do not support locally managed mode.
	Cisco TelePresence Management Suite (TMS) and Extensions	Provides scheduling, web conferencing integration, and other advanced video features.

Conferencing (continued)	Cisco WebEx Software as a Service (SaaS)	Subscription-based web conferencing delivered through WebEx Collaboration Cloud.
------------------------------------	--	--

There are three types of conferences:

- **Instant or ad hoc** — A conference that is not scheduled or organized in advance. For example, a call between two parties who add other parties to the call is an instant conference.
- **Permanent or rendezvous** — A conference that requires callers to dial a predetermined number or URI to reach a shared conferencing resource. Meet-me, static, and rendezvous are other names for this type of conference.
- **Scheduled** — A conference planned in advance with a predetermined start time. Typically, conference resources are guaranteed to be available upon the start of the scheduled conference.

Recommended Deployment

Audio and Video Conferencing

- Deploy Cisco TelePresence Server on Multiparty Media 410v (mm410v) for instant, permanent, and scheduled video conferences.
- Deploy Cisco TelePresence Conductor on the primary BE6000H server for management of the TelePresence Servers.
- Integrate the TelePresence Conductor cluster with Cisco Unified CM through SIP trunks and registered media resource conference bridges.
- Integrate the TelePresence Conductor for scheduled conferences with Unified CM through SIP trunks and route patterns.
- Deploy Cisco TelePresence Management Suite to manage TelePresence Conductor and TelePresence Servers.
- Deploy Cisco TelePresence Management Suite Provisioning Extension for provisioning of personal collaboration meeting rooms (CMRs) and Smart Scheduler via the web-based TelePresence User Portal.
- Deploy Cisco WebEx Software as a Service for scheduled web conferences.
- Integrate Cisco WebEx conferencing with on-premises voice and video conferencing through the CMR Hybrid solution.
- As an alternative, an entirely cloud-based conferencing solution is available for customers concerned with keeping capital expenditure costs low.

Note: If full redundancy is not required, a single server may be deployed without loss of functionality.

Benefits

This deployment provides the following benefits:

- Users have a consistent experience for launching and joining various types of conferences.
- A single conferencing platform provides on-premises audio and video conferencing.
- CMR Hybrid allows users to connect to meetings either from their video and audio devices or through the WebEx cloud with a meeting client running on their desktop or mobile devices.
- It provides users with real-time, high-definition video conferencing, including the ability to share content easily over a dedicated presentation channel.

Deployment Best Practices

Audio and Video Instant Conferences

For instant audio and video conferences, use an on-premises MultiParty Media 410v TelePresence Server managed by TelePresence Conductor as a media resource. TelePresence Conductor conference templates are referenced by multiple virtual IP addresses. These TelePresence Conductor virtual IP addresses register with Cisco Unified CM as instant conference bridges and are used in media resource group lists (MRGLs) and media resource groups (MRGs). Unified CM uses MRGLs and MRGs to prioritize and allocate media resources such as conference bridges, music on hold sources, announciators, transcoders, and media termination points (MTPs).

If endpoints have access to the appropriate MRGL, they can request these resources. Resources local to the initiating endpoint are preferred over remote resources ([Figure 9](#)).

Figure 9 Media Resource Group List (MRGL) Example

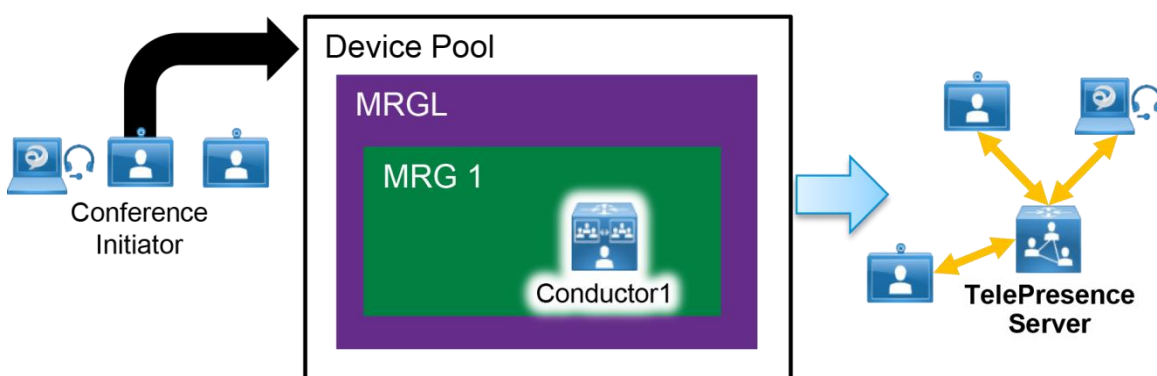

A single TelePresence Conductor cluster can have multiple conference templates configured to provide a variety of service levels and experiences for instant audio and video conferences. With this architecture, administrators can segment their users and provide restrictions on instant conference size, media properties, and additional features such as content sharing.

Audio and Video Permanent Conferences

Audio and video permanent conferences use the same TelePresence Conductor and TelePresence Server architecture as audio and video instant conferences. Permanent conferences are directed to TelePresence Conductor through Cisco Unified CM route patterns and the existing dial plan. Users can dial either a directory number or a URI to reach an audio or video permanent conference. Cisco TelePresence Conductor handles instant and permanent conferences on a first-come, first-served basis, making them best-effort services.

Personal Cisco Collaboration Meeting Rooms (CMR) Premises

Cisco CMR Premises greatly simplifies the deployment of on-premises audio and video conferencing. Cisco CMRs enable an administrator to quickly configure and provision conferences, providing each user with their own personal conference space. Users browse to a website with a simple interface and create their conference, specifying preferences such as welcome screen text, participant layout, and conference PIN protection.

Cisco TelePresence Management Suite Provisioning Extension (TMSPE) enables rapid provisioning of TelePresence users and their respective personal CMRs for large-scale deployments. TMSPE runs on the same Windows Server as the TMS application.

Administrators create a CMR template in TMS to specify the base dial plan for CMR URIs and numeric aliases. When users create and personalize their CMRs, they receive instructions for how to dial in to their meetings, and these numbers and URIs are in line with the CMR template configured in TMS. As users create their CMRs, TMSPE provisions and configures the necessary settings on TelePresence Conductor, and no further interaction is needed from an administrator.

Scheduled Video Conferences

For the conferencing resource for scheduled video conferences, use the same Cisco TelePresence Server on the MultiParty Media 410 managed by TelePresence Conductor (Figure 10). Integrate the TelePresence Conductor to Cisco Unified CM with SIP trunks, and manage it through Cisco TMS.

The conferences can be scheduled in either of two ways:

- Shared bridge scheduling

When a single TelePresence Server is used for instant, permanent, and scheduled conferencing, the TMS does not account for the resources utilized by the instant and permanent conferences. Thus the scheduling request made to TMS will be on a best-effort basis depending on the availability of resources on the TelePresence Server.
- Dedicated bridge scheduling

When a dedicated TelePresence Server is used for scheduling conferences, the TMS can account for the usage of resources and can guarantee the availability of ports at the time of the conference.

Note: TMS scheduling via TelePresence Conductor is not able to optimize the conferencing resources based on the call rate, but it can optimize on the basis of port usage.

Figure 10 Architecture for Video Conferencing

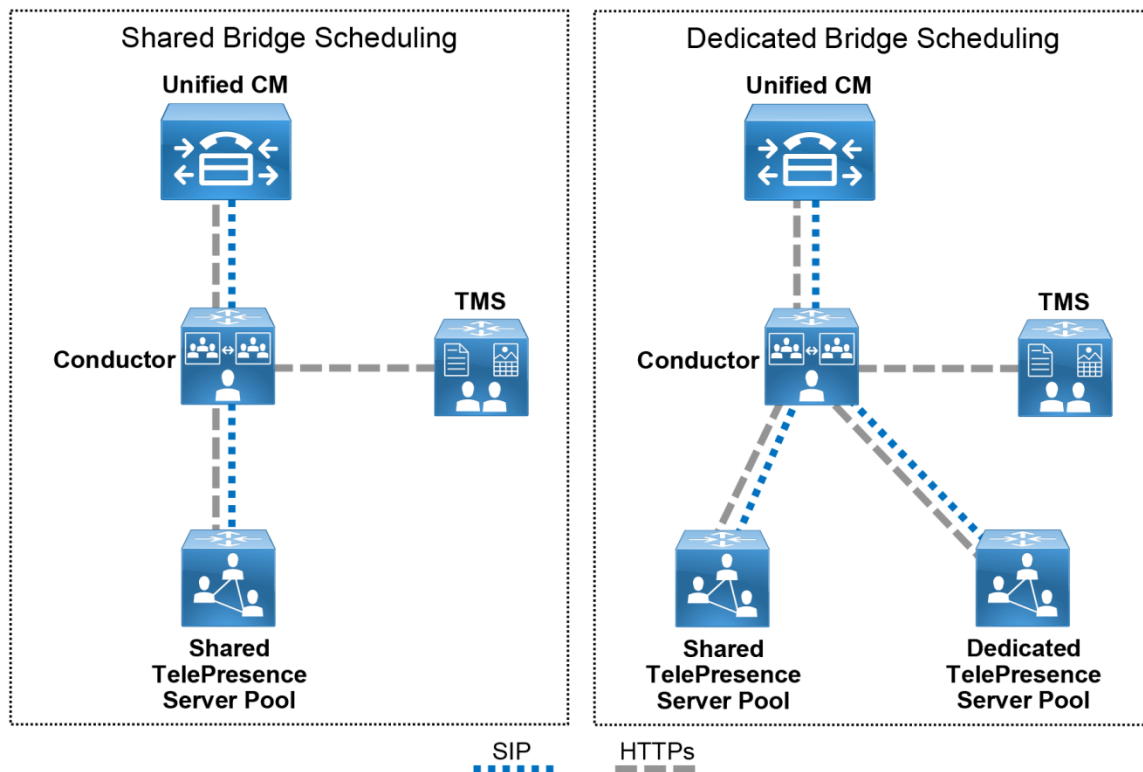

Cisco WebEx Meetings Server

Cisco WebEx Meetings Server is a secure, fully virtualized WebEx conferencing solution with all of its equipment deployed on-premises behind the firewall. This option works well for customers that have strict requirements forbidding storage of any data outside the company.

Cisco WebEx Meetings Server builds on top of the Cisco Collaboration infrastructure and extends the implementation of Cisco Unified CM to include conferencing. Connect Cisco WebEx Meetings Server and Cisco Unified CM by means of SIP trunks to provide services for attendees dialing into the system and for system callback to attendees to join the meetings.

Deploy Cisco WebEx Meetings Server with redundancy to provide system availability in the event of component failures. With high availability, the system uses the N+1 redundancy scheme and runs in active/active mode. In addition, we recommend enabling high-quality (HQ) video for the optimal video experience and integrating WebEx Meeting Server with the organization's LDAP directory so that users can use the same credentials to access the meeting scheduler.

For additional information on Cisco WebEx Meetings Server, see the [product documentation](#).

Cisco WebEx Software as a Service

Cisco WebEx SaaS is a subscription-based service delivered through the WebEx Collaboration Cloud, where all the meetings are hosted. Few components are deployed on-premises, so this option is well suited for customers who manage their communications budget as an operational expenditure.

WebEx Collaboration Cloud is highly available and has redundancy built into the infrastructure to handle component failure. Deploy Cisco WebEx SaaS using WebEx audio for web conferencing. We highly recommend enabling HD video for the optimal video experience and enabling Single Sign-On (SSO) to allow integration with the organization's LDAP directory for access using common credentials.

For additional information on Cisco WebEx Software as a Service, see the [product documentation](#).

Cisco Collaboration Meeting Rooms (CMR) Hybrid

Cisco CMR Hybrid combines the scheduled on-premises video conference and the WebEx cloud-based conference into a single meeting. Participants can join the scheduled meeting using the WebEx meeting client or a TelePresence device, and they experience two-way video, audio, and content sharing from their respective devices. As illustrated in [Figure 11](#), we recommend deploying Cisco Expressway-C and Expressway-E to handle calls to and from the WebEx cloud, and no Cisco Expressway Rich Media Session Licenses are required for calls made to the WebEx cloud. For CMR Hybrid, you can use the same Cisco TelePresence Server on MultiParty Media 410 managed by TelePresence Conductor, as used for scheduled video conferences (see [Figure 10](#)).

Note: For simplicity the entire BE6000H architecture is not shown in [Figure 11](#).

Figure 11 Architecture for CMR Hybrid

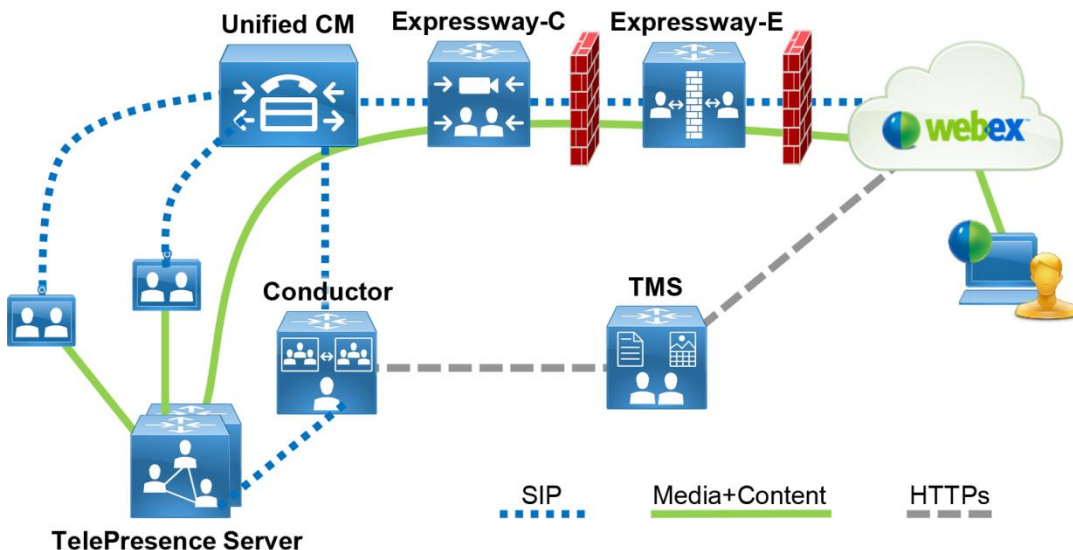

Collaboration Meeting Rooms Cloud (CMR Cloud)

Cisco Collaboration Meeting Rooms (CMR) Cloud is one of the deployment options available for CMR. Cisco CMR Cloud is a video collaboration service that couples WebEx Personal Rooms with the cloud-based WebEx Video Bridge into one always-available meeting experience from any video device (Figure 12).

CMR Cloud adds the following benefit to Cisco WebEx SaaS:

- A video collaboration service that integrates voice, video, and content sharing technologies into one meeting experience
- Always available personal room with your own unique ID that never changes
- Simple-to-join capability from any third-party, standards-based video device, Cisco TelePresence endpoint, soft client, or Microsoft Lync client
- Ability to add-on CMR Cloud as a service option to a Cisco WebEx Meeting Center subscription
- Scalability to support up to 25 standards-based video endpoints as well as 500 audio users and up to an additional 500 video-enabled WebEx Meeting Center users in a single meeting
- Opportunity to record and share for future viewing

Figure 12 Architecture for CMR Cloud

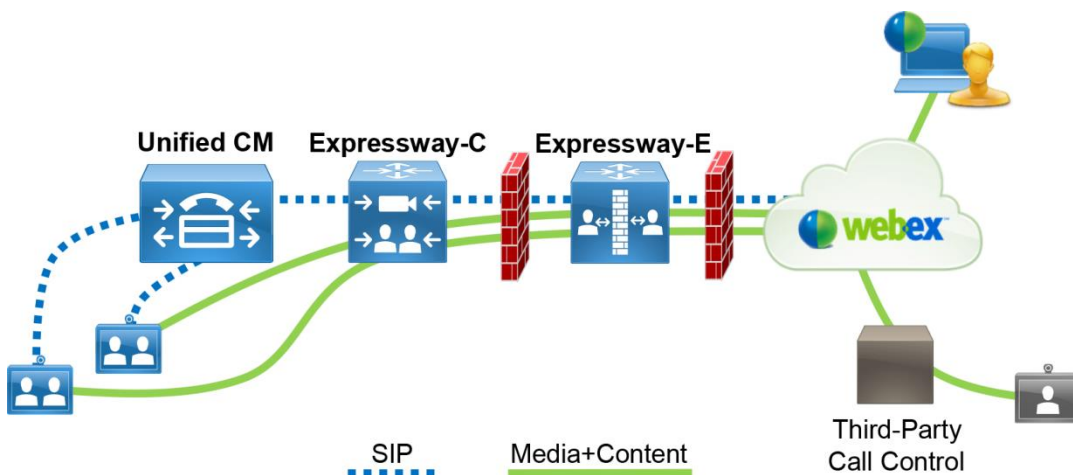

Cisco TelePresence Management Suite and Extensions

Cisco TelePresence Management Suite (TMS) runs on a virtualized Windows Server instance, and it provides the scheduling and call initiation functions for the organization. Users are imported from Active Directory, and the permissions model allows for access control to various components and configured systems. User features such as directories and One Button to Push (OBTP) are also provided to controlled endpoints by the TMS application. TMS utilizes a Microsoft SQL database for all information about users, devices, and scheduled conferences. In addition to the core TMS application, the following two additional applications provide supplemental features and services to enhance the overall video communications experience.

Cisco TelePresence Management Suite Provisioning Extension (TMSPE)

TMSPE provides the functionality to create collaboration meeting rooms (CMRs) for users according to the permissions and feature limits defined by the administrator. In addition to the CMR functionality, TMSPE also engages other scheduling options, besides the administrator booking page, within the TMS application. One of these options includes the ability to schedule CMR Hybrid, bringing WebEx functionality and scale to meetings.

Cisco TelePresence Management Suite Extension for Microsoft Exchange (TMSXE)

TMSXE allows end users to schedule meetings using their Microsoft Outlook clients and including room video systems. Room resources in Microsoft Exchange are mapped to systems within TMS. When resources are booked in Exchange, TMSXE provides TMS with the following information:

- User requesting the meeting
- Meeting subject
- All TMS associated resources

The TMS scheduling engine then uses conference templates to build the meeting and provides connection information back through Exchange to the end user.

Recommended Deployment

Deploy a single instance of TMS for the organization, and leverage the integrated system navigator folder structure to organize all endpoints and infrastructure devices. Even multinational and global organizations can benefit from a single instance of TMS to facilitate video connections.

For Cisco BE6000 deployments, TMS and all of its supporting components can be installed on a single Windows server instance. This is called a TMS Regular Deployment and is subject to the following constraints:

- TMS Solution — TelePresence Management Suite (TMS), TelePresence Management Suite Provisioning Extension (TMSPE), TelePresence Management Suite Extension for Microsoft Exchange (TMSXE), and an embedded Microsoft SQL server all reside on a single virtual machine.
- TMS
 - Maximum of 200 controlled systems
 - Maximum of 100 concurrent participants
 - Maximum of 50 concurrent ongoing scheduled conferences
- TMSXE
 - Up to 50 endpoints bookable in Microsoft Exchange
- TMSPE
 - Up to 1,000 Collaboration Meeting Rooms

Redundancy for TMS and TMS Extensions

Redundancy of TMS and its extensions is different from other components in the Preferred Architecture. TMS and TMSPE operate in an active/passive node model instead of clustering.

Redundancy for TMS requires an external Microsoft SQL database on a separate server from the TMS application server. This instance of SQL may be shared by other applications within the organization. Also necessary for redundancy to work effectively, a network load balancer (NLB) must be deployed in front of the TMS/TMSPE application server. Because this is outside the scope of a TMS deployment on the BE6000H, redundancy for TMS and its extensions is not included in the Cisco PA for Midmarket Collaboration.

See the [Cisco TelePresence Management Suite Installation and Upgrade Guide](#) for details on larger deployments with full redundancy for TMS and TMS extensions.

Benefits

The benefits of a properly configured and deployed TMS instance, with the software extensions, provide end users with a user-friendly and feature-rich experience.

- Conferences for video, voice, and web participants are scheduled through a single unified interface.
- On supported endpoint devices, users can launch a conference session with One Button to Push (OBTP), according to the device schedule.

Support for Multiple Call Processing Sites

Organizations may choose to implement more than one Cisco TelePresence Conductor cluster for any of the following reasons:

- **Administrational separation** — This includes the need to keep users from different parts of the organization on separate infrastructures or to have different departments operate different parts of the communications infrastructure.
- **Geographic footprint** — Physical limitations such as excessive latency between endpoints and conferencing resources could degrade the user experience. (For example, US users might not have a productive collaborative meeting if they use conferencing resources located in Europe.)
- **Multiple Unified CM clusters** — If more than one Unified CM cluster is already deployed due to the previous reasons, we recommend also deploying multiple TelePresence Conductor clusters.

Deploy multiple TelePresence Conductor clusters along with local TelePresence Server resources (Figure 13). Implement a global dial plan, as discussed in the [Call Control](#) section, to enable users to access conferences regardless of where the TelePresence Conductor or TelePresence Server is located.

Note: TMS supports only two-node TelePresence Conductor clusters. Both Conductor nodes have to be added manually to TMS.

Figure 13 Multiple Call Processing Sites with Conferencing

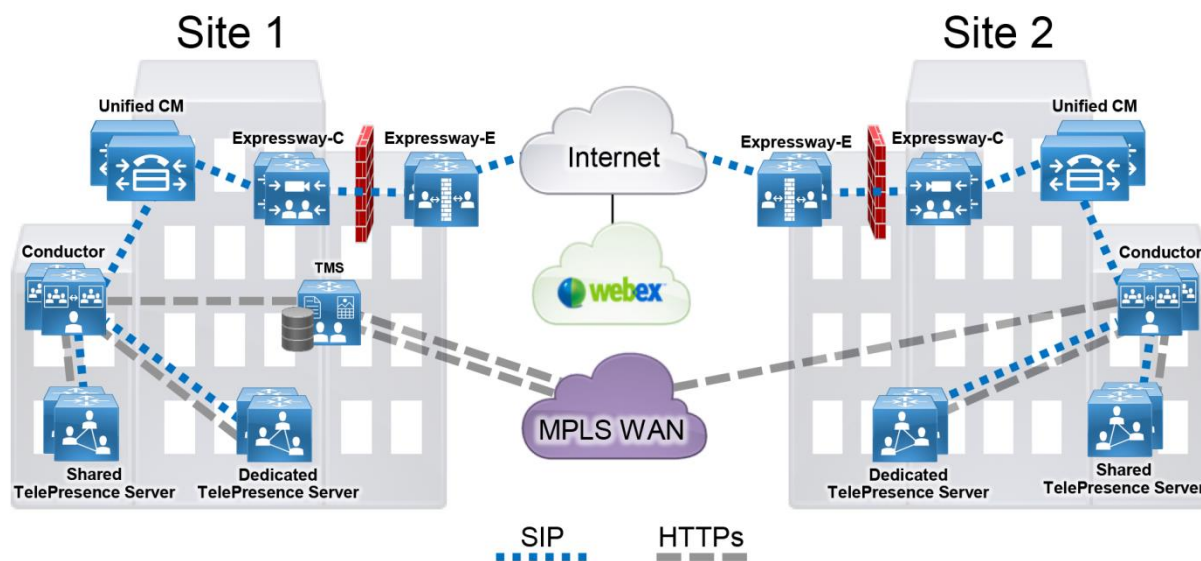

Collaboration Edge

Business demand for connectivity between organizations by leveraging the Internet has increased significantly over the past few years. For many organizations, this connectivity is a fundamental requirement for conducting day-to-day activities. Moreover, securely connecting mobile workers and remote sites to each other and to headquarters is critical functionality that enables organizations to accomplish their business goals. The Cisco PA for Midmarket Collaboration addresses these needs with the Collaboration Edge architecture shown in [Figure 14](#).

Figure 14 Architecture for Collaboration Edge

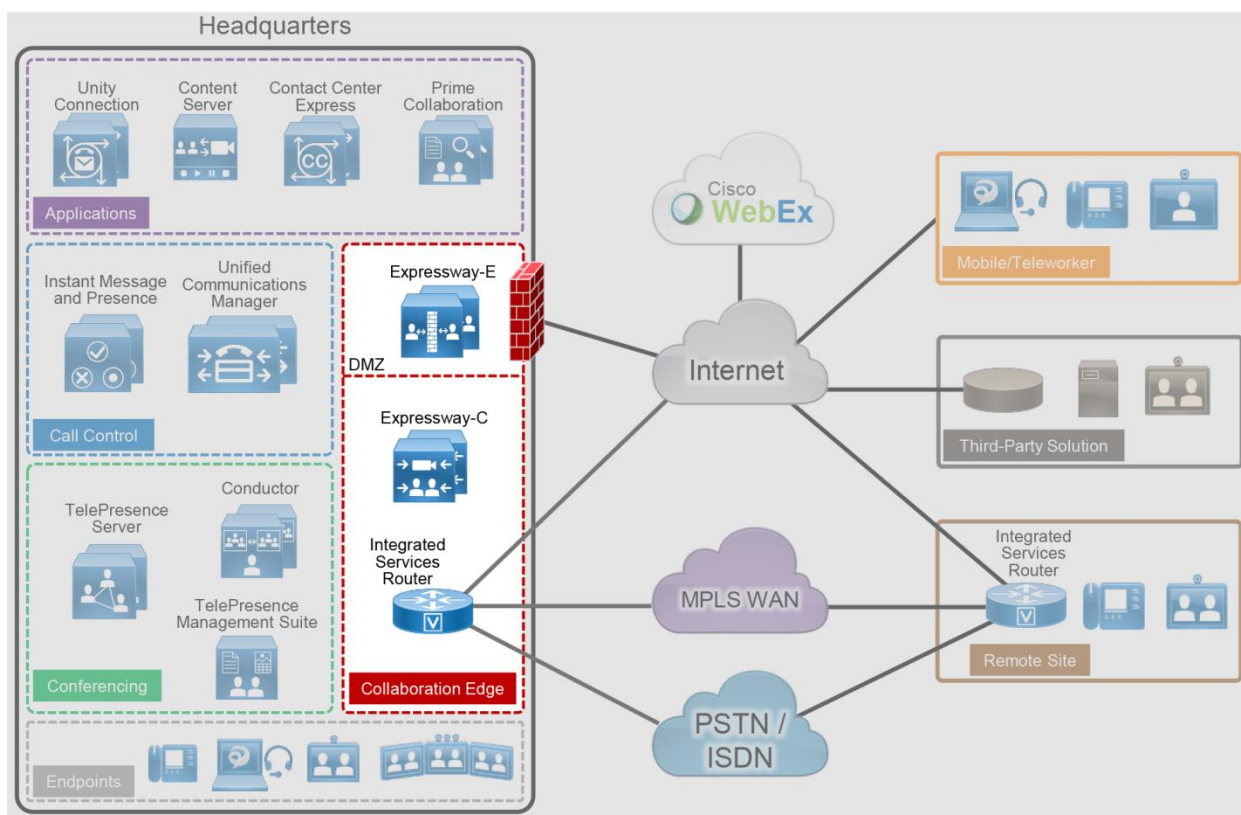

[Table 8](#) lists the roles of the Collaboration Edge components in this architecture and the services they provide.

Table 8 Components for Collaboration Edge

Module	Component	Description
Collaboration Edge	Cisco Expressway-E	The traversal server that enables secure VPN-less mobile and remote access for TelePresence endpoints and Jabber clients. The traversal server resides in the DMZ. The solution also provides business-to-business calling, protocol interworking, and cloud connectivity.
	Cisco Expressway-C	The traversal client that creates a secure, trusted connection through the firewall to Expressway-E. The traversal client resides inside the enterprise network. The solution provides mobile and remote access, business-to-business calling, protocol interworking, and cloud connectivity.
	Cisco ISR with PSTN interfaces	Enables local PSTN connectivity
	Cisco ISR with Cisco Unified Border Element (CUBE) software	Enables connectivity from an organization's network to the service provider network for SIP trunks via CUBE

Recommended Deployment

Headquarters

- Deploy a Cisco Expressway-C and Expressway-E server cluster pair to enable remote Cisco IP Phones 7800 Series, 8800 Series, DX Series, Jabber and TelePresence video endpoint registrations; IM and Presence; and secure business-to-business connectivity through the firewall. Cluster both Expressway-C and Expressway-E servers in both pairs.
- Deploy Cisco ISR as the PSTN gateway, or enable CUBE functionality on the Cisco ISR for voice connectivity from the organization's network to the service provider network through a SIP trunk.

Note: If full redundancy is not required, a single server pair (Expressway-C and Expressway-E) may be deployed.

Remote Sites

- Deploy Cisco ISR as the PSTN gateway.

Teleworker Sites

- For video-enabled sites, deploy Cisco TelePresence endpoints utilizing the Expressway-C and Expressway-E infrastructure at headquarters or another site.
- In addition, the Cisco Jabber client can be used without the VPN, regardless of the location of the endpoint (internal or external to the organization).
- Legacy audio and video-enabled phones can be deployed with VPN technologies. Depending on the phone type, some of them have an embedded VPN client and may be deployed without a VPN hardware client. For more information on each phone model, refer to the [product documentation](#).

Benefits

This deployment provides the following benefits:

- The Cisco ISR supports standards-based interfaces and various PSTN types, so it can be deployed globally.
- Instead of traditional PSTN interfaces, CUBE functionality can be enabled on the Cisco ISR if a SIP trunk is used.
- The Cisco ISR can be used for WAN connectivity.
- Cisco Expressway provides calling, presence, instant messaging, voicemail, and corporate directory services for Cisco Jabber and TelePresence video endpoints.
- Cisco Expressway enables video communication between organizations, partners, and vendors over the Internet.

Deployment Best Practices

Cisco Expressway

Cisco Expressway provides secure firewall and NAT traversal for mobile Cisco IP Phones 7800 and 8800 Series, Cisco Jabber, and TelePresence video endpoints ([Figure 15](#)) and secure business-to-business communications ([Figure 16](#)). Cisco Expressway consists of two applications: Expressway-C and Expressway-E.

Deploy Cisco Expressway-C inside the network, and deploy Expressway-E in the demilitarized zone (DMZ) by connecting separate network ports on Expressway-E to the organization's network and to the DMZ.

Cisco fully supports a virtualized Expressway-E in the DMZ; however, a dedicated server can be deployed based on the company's security requirements.

Figure 15 Traversal for Registrations Through Firewall with Expressway-C and Expressway-E

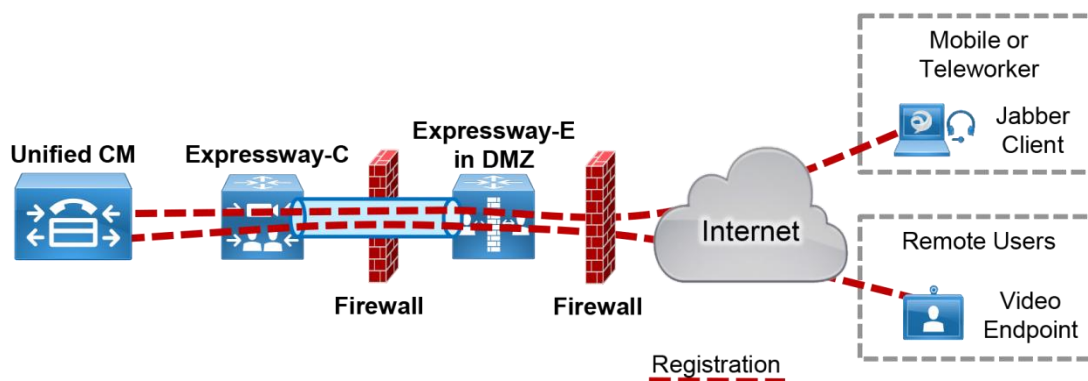
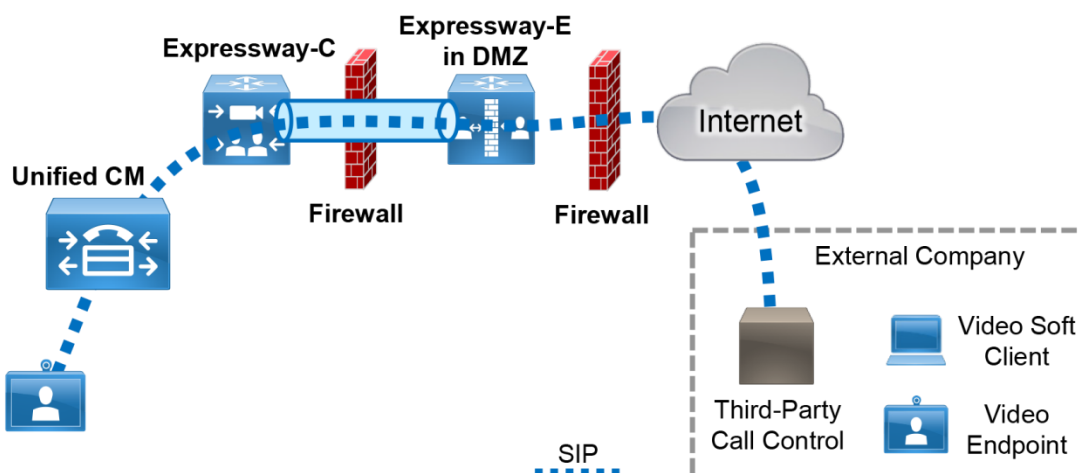

Figure 16 Traversal for Business-to-Business Calls Through Firewall with Expressway-C and Expressway-E



Cisco Expressway-C

Place Expressway-C in the trusted network inside the organization. Deploy Expressway-C to:

- Function as a traversal client and establish a secure connection to Expressway-E through the firewall
- Establish secure or non-secure connection to Cisco Unified CM
- Integrate with an existing internal video network that uses H.323
- Enable business-to-business calls to external entities that communicate using SIP or H.323
- Provide interworking between H.323 and SIP protocols for H.323 business-to-business communications
- Enable mobile and remote access capabilities and call signaling for Cisco-supported endpoints, directing them to Cisco Unified CM for SIP registration and/or the IM and Presence Service (See the [Endpoints](#) section for information on which endpoints support mobile and remote access.)

Cisco Expressway-E

Because Expressway-E is reachable directly from the untrusted, external network, it should be placed in a DMZ for security. The organization's firewall policies control communications to and from this server. Deploy Expressway-E to:

- Function as a traversal server and allow secure communications to and from Expressway-C
- Enable audio and video connections to other organizations using SIP or H.323 on the Internet
- Provide secure communications to cloud-based services, such as CMR Cloud to the WebEx cloud
- Provide DNS SRV lookup service to resolve outbound calls and to receive inbound calls over the Internet
- Process registration and IM and presence information from Cisco endpoints on the external network and use secure traversal communications to pass the information to Expressway-C
- Provide interworking between protocols (between SIP and H.323, and between IPv4 and IPv6) for business-to-business communications

Connectivity for Audio and Video over the Internet

URI dialing is the best practice for audio and video dialing over the Internet. Cisco recommends assigning alphanumeric URIs to all devices that will send or receive calls over the Internet. Any device on Cisco Unified CM can be reached over the Internet by dialing the assigned alphanumeric SIP URI or the required directory number (DN) by dialing `<+E.164 number>@domain`. For example, a Jabber user might have a SIP URI set to `alice@ent-pa.com` and a phone number set to `+14085551234`. If someone dials `alice@ent-pa.com` or `+14085551234@ent-pa.com` from an external location on the Internet, Alice would receive the call on the Jabber client and all devices that share the same number.

Users on Cisco Unified CM have to dial the full SIP URI to reach a user or device from a different organization over the Internet.

The architecture for business-to-business Internet connectivity includes a client/server solution: Expressway-C and Expressway-E. Both servers can be deployed in standalone mode or in a cluster. Deploy the same number of cluster peers for Expressway-C clusters as for Expressway-E clusters.

We recommend deploying dedicated Expressway-C and Expressway-E clusters per customer-chosen Internet breakout to minimize having outbound business-to-business calls traverse the WAN by routing them, instead, to an Internet breakout close to the client that initiated the call. This minimizes the business-to-business call-related utilization of the enterprise WAN.

Considerations for Outbound Business-to-Business Calls

- When multiple Expressway-C and Expressway-E pairs are deployed, Unified CM can redirect an outbound call to the edge server that is nearest to the calling endpoint, thus minimizing WAN traffic.
- For call routing over the Internet, use public DNS service records. DNS SRV records map a domain to an edge system servicing that domain for that protocol. For example, if a remote user dials `alice@ent-pa.com`, then the remote system uses DNS to query for the host offering the SIP service for the domain `ent-pa.com`.

Mobile and Remote Access

The mobile and remote access feature enables Jabber clients and Cisco 7800, 8800, DX, SX, C, and MX Series endpoints to register securely to Cisco Unified CM through Expressway-E and Expressway-C without any VPN. A Jabber client can send and receive several types of collaboration flows (audio, video, instant messaging, and presence), while a hardware endpoint can send audio and video streams. When multiple edges are deployed, we recommend using Geo-DNS services to provide the best network option based on assigning the closest edge in the DNS response.

The mobile and remote access functionality also leverages Expressway-C and Expressway-E. Both business-to-business and mobile and remote access services are supported on the same server.

PSTN Gateway

Because landlines and mobile phones use the PSTN for local and international calls, external connectivity to the PSTN from an organization’s IP telephony network is a requirement ([Figure 17](#)).

Figure 17 PSTN Connectivity

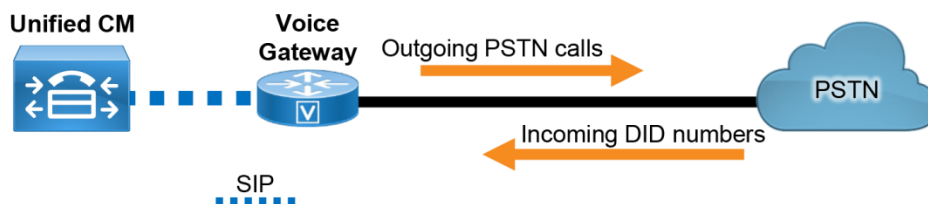

Use Cisco ISR with a time-division multiplexing (TDM) module as the PSTN gateway at headquarters. This configuration enables the gateway to implement media interworking for the organization’s incoming and outgoing PSTN calls.

At remote sites, deploy a Cisco ISR for local PSTN connectivity using voice modules. For more information about Cisco ISR, see the [data sheet](#).

Table 9 Recommended PSTN Gateways

Location	PSTN Gateway
Headquarters	ISR G2 3900 series
Remote Sites	ISR G2 2900 series

If SIP trunks are used to connect to a service provider for voice calls, enable CUBE functionality on the Cisco ISR that is deployed at headquarters. When deploying Cisco ISR with CUBE functionality, observe the following recommendations:

- Deploy CUBE in the demilitarized zone (DMZ).
- Enable the firewall for NAT to convert the external address to the address of CUBE.
- Enable the firewall to inspect voice calls.

Cisco Unified CM routes calls through SIP trunks to gateways, CUBE, or Cisco Expressway based on the dial plan. For dial plan recommendations, see the [Call Control](#) section.

PSTN Connectivity for Voice

Enable PSTN connectivity for voice calls by using either an analog or ISDN interface. A Cisco ISR with analog or ISDN cards provides these interfaces. Connectivity is usually local, and a site with PSTN interfaces uses its local ISR as a voice gateway. Follow these recommendations for deploying an ISR for PSTN connectivity:

- PSTN interface (analog or ISDN)
 - The device providing these interfaces is a Cisco ISR with analog or ISDN cards.
 - Connectivity is usually local; a site with PSTN interfaces uses its local ISR as a voice gateway.
 - Redundancy is achieved by deploying multiple ISRs. Cisco Unified CM has the ability to route traffic to the closest available router.
- SIP trunks to the service provider, and ISR or CUBE as a border element
 - This deployment is typically used in a centralized architecture. Remote sites either do not have local connectivity, or they have local connectivity but use it only for backup voice services. In this case the WAN connectivity has to be sized to accommodate PSTN calls traversing the WAN to the central site where CUBE is deployed.
 - Redundancy can be achieved by deploying multiple ISRs, sometimes to different voice carriers. Cisco Unified CM has the ability to route traffic to the closest available router.

ISDN Connectivity for Video

Although many organizations now use the Internet for business-to-business video connectivity, legacy interoperability with ISDN networks might still be required if the called party is not reachable through the Internet. To provide ISDN connectivity for video, use the Cisco TelePresence ISDN GW 3241 as a standalone unit.

Applications

In addition to the call processing and media resource components, the Cisco PA for Midmarket Collaboration includes the following Cisco applications to enhance usability, functionality, and management (Figure 18):

- Unity Connection to provide messaging
- TelePresence Content Server for recording individual video calls and video conferences
- Unified Contact Center Express (CCX) for customer care
- Prime Collaboration Provisioning Standard for user and device provisioning

Figure 18 Architecture for Applications

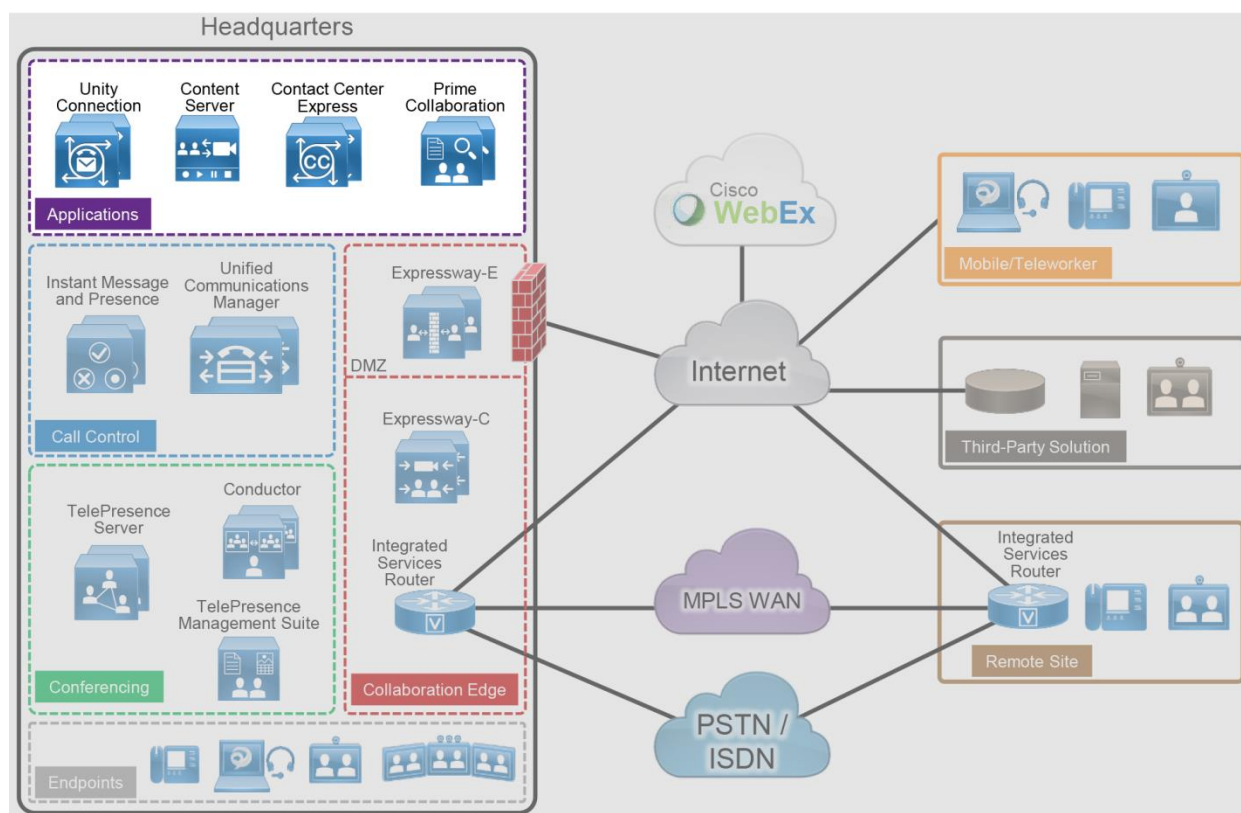

Table 10 lists the roles of the application components in this architecture and the services they provide.

Table 10 Components for Applications

Module	Component	Description
Applications	Cisco Unity Connection	Provides unified messaging and voicemail services
	Cisco TelePresence Content Server	Provides video and conference recording
	Cisco Unified Contact Center Express (CCX)	Provides customer interaction and interactive voice response (IVR) services
	Cisco Prime Collaboration Provisioning Standard	Provides administrative functions (moves, adds, changes, and deletions) for Cisco Unified Communications applications

Cisco Unity Connection

Cisco Unity Connection enables users to access and manage voice messages in a variety of ways, such as by email inbox, web browser, Cisco Jabber, Cisco Unified IP Phone, TelePresence, smartphone, tablet, and many more. Users can interact with Unity Connection either through phone keypad keys or through voice commands that they speak into the phone handset, headset, or speakerphone.

Recommended Deployment

- Deploy two Unity Connection servers for each Cisco Unified CM cluster to provide high availability and redundancy.
- Use SIP trunks to integrate Unity Connection with Unified CM. Configure two SIP trunks, one for each Unity Connection server in a pair.
- Enable the speech-activated voice command interface to maximize productivity of mobile workers.

Note: If full redundancy is not required, a single server may be deployed without loss of functionality.

Benefits

- Users can access the voicemail system and retrieve their voice messages by using their IP phones, mobile devices, and various email client applications with either a dialed number or a SIP URI.
- Cisco Unity Connection allows users to customize personal settings from a web browser.
- Cisco Unity Connection offers a natural and robust speech-activated user interface that allows users to browse and manage voice messages using simple and natural speech commands.

Deployment Best Practices

Cisco Unity Connection supports a cluster configuration in active/active mode to provide both high availability and redundancy. A Unity Connection cluster consists of a maximum of two nodes, one publisher and one subscriber in an active/active deployment (Figure 19). If one Unity Connection node fails, the other active node in the cluster handles all the calls, IMAP requests, and HTTP requests for the Unity Connection cluster. Each server in the Unity Connection cluster must have enough voice messaging ports to handle all calls for the cluster.

Figure 19 Cisco Unity Connection Cluster

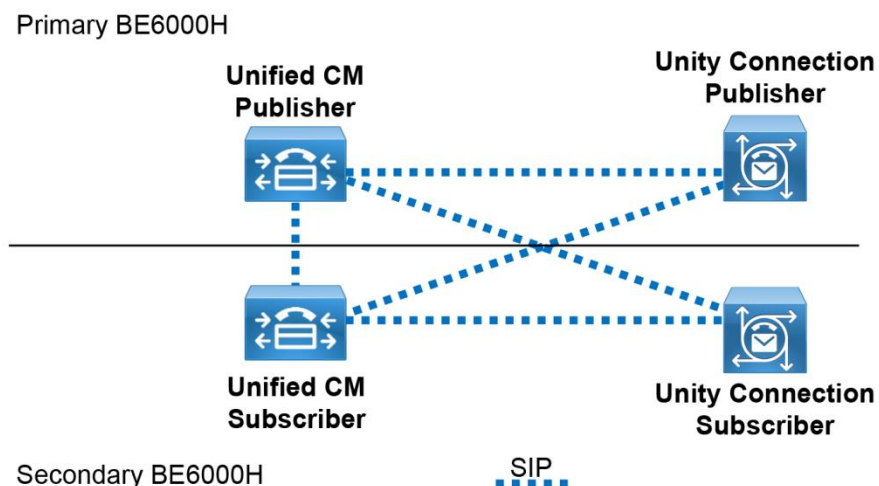

Single Inbox, one of the unified messaging features in Cisco Unity Connection, synchronizes voice messages in Unity Connection and Microsoft Exchange mailboxes. Unity Connection supports the Single Inbox feature with on-premises Microsoft Exchange, cloud-based Microsoft Exchange, or Microsoft Office 365 server, thereby providing unified messaging for voicemail. All voice messages, including those sent from Cisco Unity Connection ViewMail for Microsoft Outlook, are first stored in Cisco Unity Connection and are immediately replicated to the Microsoft Exchange mailbox of the recipient. This feature can be configured for each individual user separately.

Unity Connection imports the user information from the enterprise LDAP directory.

Each mailbox must have a unique voicemail number. Unity Connection supports both E.164 and +E.164 formats for the extension of an end-user account (user with a voice mailbox). Unity Connection also supports alternate extensions per user.

The voicemail pilot number designates the directory number that users dial to access their voice messages. Unified CM automatically dials the voice messaging number when users press the Messages button on their phone. The voicemail pilot number can be an internal extension or a dedicated PSTN number.

Visual Voicemail allows user to access voicemail using the graphical interface on the IP phone. Users can view a list of messages and play messages from the list. Users can also compose, reply to, forward, and delete messages. Each voicemail message displays data including the date and time when the message was left, urgency level, and message length.

For more information on Cisco Unity Connection, refer to the [product documentation](#).

Cisco Unified Contact Center Express

Cisco Unified Contact Center Express (CCX) enables organizations to provide powerful agent queuing and interactive voice response (IVR) services to internal and external customers. These services enable customers to connect easily with the right employees in an organization for sales inquiries or product support.

Recommended Deployment

Deploy two Unified CCX servers for high availability, with one active node and one standby node to handle failover in case of component failure (Figure 20). Also configure a primary and a backup Cisco BE6000H server for the JTAPI interface of the Telephony and Resource Manager-Contact Manager (RmCm) subsystems in Unified CCX.

Note: If full redundancy is not required, a single server may be deployed without loss of functionality.

Figure 20 Cisco Unified Contact Center Express Cluster

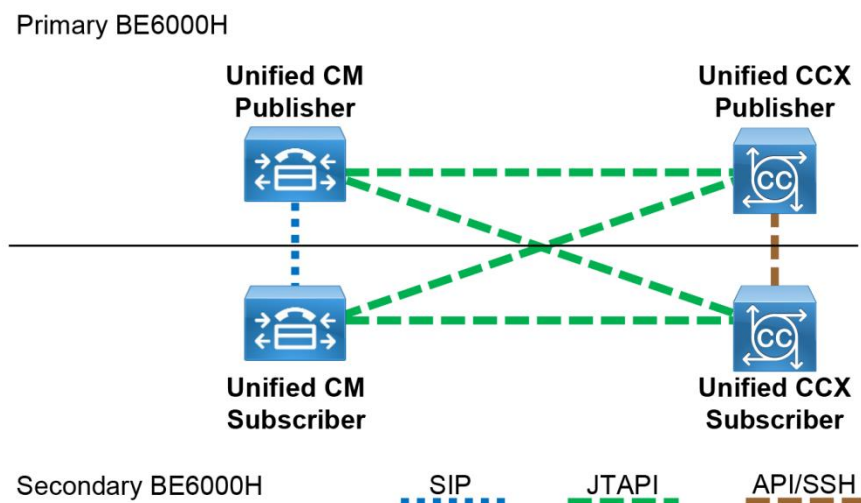



For contact center deployments, use Cisco Finesse as the agent and supervisor desktop. Cisco Finesse is a browser-based application implemented through a Web 2.0 interface with no client-side installation required, and it is highly customizable. In addition, Cisco Finesse supports E.164, which adheres to the dial plan design recommendations discussed in the [Call Control](#) section.

Benefits

This deployment provides the following benefits:

- Recorded greetings and customized prompts provide sophisticated call handling.
- Unified CCX supports external customer interaction.
- Unified CCX facilitates internal company communication for activities such as help desk.

Deployment Best Practices

As with the other components in the Cisco PA for Midmarket Collaboration, Unified CCX should be deployed with high availability that includes active and standby nodes. Unified CCX downloads the end-user information from Unified CM that is synchronized with the organization's LDAP directory. This minimal configuration enables external callers to dial a single number into the organization and then use simple dial-by-name or dial-by-extension functionality without the need for telephone operators to connect external calls. Depending on the organization's structure and business model, Unified CCX could also be used for the following additional workflow configurations:

- Sales
- Customer support
- Internal IT helpdesk
- Human resources

These automated, call-directed workflows provide value to the organization by quickly and easily connecting a person with a need to the appropriate resource within the organization for assistance.

For information about Cisco Unified Contact Center Express, see the [data sheet](#).

Cisco TelePresence Content Server

The Cisco TelePresence Content Server simplifies the process of capturing and sharing many types of video calls, conferences, and content throughout your organization. The TelePresence Content Server interoperates with Cisco and third-party Session Initiation Protocol (SIP) video endpoints, and it can record and stream high-quality video and content for on-demand access. The Content Server comes in various deployment options and can be used either as an appliance or as a virtualized service on Cisco Business Edition solutions or on optimized Cisco Unified Computing System (UCS) platforms.

Cisco TelePresence Content Server can be used to:

- Capture video and presentations for live streaming and video-on-demand (VoD) viewing
- Provide compatibility with Cisco TelePresence or third-party standards-based video endpoints
- Support Microsoft Active Directory authentication through Lightweight Directory Access Protocol (LDAP)
- Allow for basic video editing and sharing functionality using a simple web interface

Recommended Deployment

The TelePresence Content Server can be used for recording in the following scenarios:

- Individual users can dial into the Content Server and self-record their calls.
- The Content Server can be added as a participant to an instant conference and used to record the instant conference.

The TelePresence Content Server must be configured in trunk mode for use with Cisco Unified Communications Manager. The Content Server supports the following features:

- MPEG-4 format for playback using Apple QuickTime or Adobe Flash Player
- One live streaming recording in Flash Player or QuickTime, with output sizes of small, medium, or large using the External Streaming Server
- One on-demand recording in Flash Player or QuickTime, with output sizes of small, medium, or large using the Internet Information Server (IIS) as well as the External Media Server and HD video

Currently the TelePresence Content Server does not support in-box streaming, Windows Media Video (WMV) format, or clustering.

Redundancy

The TelePresence Content Server currently does not support clustering on the BE6000M or BE6000H platforms.

Benefits

The TelePresence Content Server provides the following benefits:

- Live and on-demand streaming
- Impromptu call support with dial-in capabilities
- Ability to record video from any Session Initiation Protocol (SIP) videoconferencing unit
- Integration with Cisco Unified Communications Manager for conference recording and streaming
- Content creation from anywhere using Cisco TelePresence Expressway technology
- Compatibility with all major streaming formats, including Adobe Flash Player and Apple QuickTime

Cisco Prime Collaboration Provisioning Standard

Cisco Prime Collaboration Provisioning Standard provides a centralized provisioning interface that simplifies administration of day-to-day activities such as moves, adds, changes, and deletions (MACD) of user devices and services in an organization (Figure 21).

Figure 21 Cisco Prime Collaboration Provisioning Standard

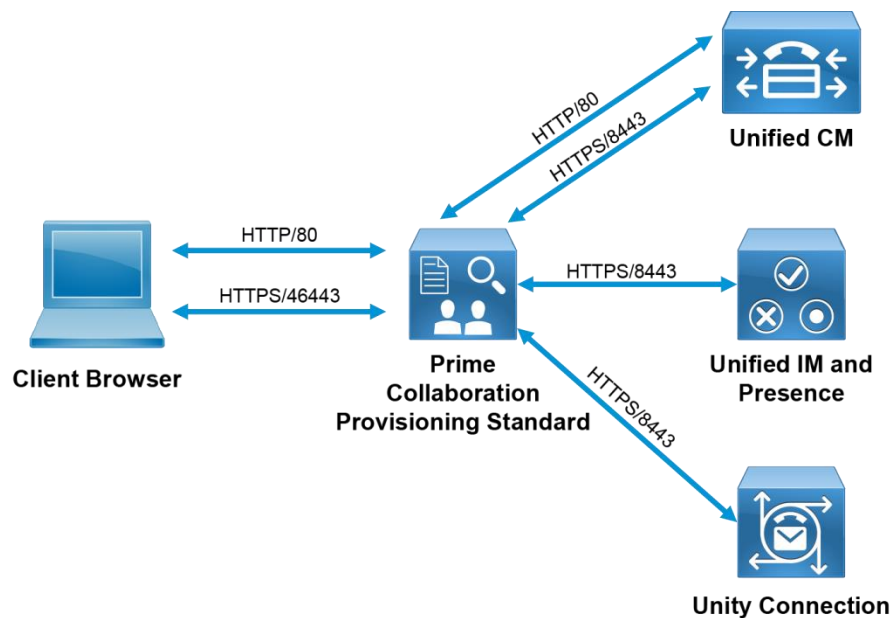

Recommended Deployment

Deploy Cisco Prime Collaboration Provisioning Standard on the primary BE6000H server. A single instance of Cisco Prime Collaboration Provisioning Standard can support the entire organization.

Benefits

- A consistent, unified approach simplifies the management of multiple Cisco collaboration technologies such as Cisco IP Phones, Cisco Unified CM, and other application servers.
- Features such as bulk-based provisioning, phone MACDs, and consolidated views simplify user and service-related configuration and administration.
- A self-service portal eases support by enabling users to make authorized changes.



Appendix

Product List

This product list identifies the Cisco products in the Preferred Architecture for Midmarket Collaboration, along with their relevant software versions.

Product	Product Description	Recommended Software Version
Cisco Unified Communications Manager and IM and Presence Service	Call control, instant messaging, and presence services	11.5(1)
Cisco Unity Connection	Voicemail services	11.5(1)
Cisco Expressway-C and Expressway-E	Mobile and remote access and business-to-business communications	X8.8
Cisco Contact Center Express	Customer interaction management services	11.5
Cisco Prime Collaboration Provisioning Standard	Provisioning and monitoring services for voice and video deployments	11.2
Cisco TelePresence Conductor	Video conferencing resource management	XC4.2
Cisco TelePresence Server	Audio and video conferencing resources	4.3
Cisco TelePresence Management Suite	Scheduling video conferencing resources	15.2
Cisco TelePresence Content Server	Recording video calls and conferences	7.1
Cisco ISR G2	PSTN gateway, SRST, and external connectivity to the Internet	IOS 15.5(2)T
Cisco IP Phone 7800 Series	General office use, multi-line phone	11.0(1)
Cisco IP Phone 8800 Series	General office use	11.0(1.11)
Cisco Unified IP Conference Phone 8831	IP conference phone	10.3(1)SR2
Cisco Jabber	Soft client with integrated voice, video, voicemail, and instant messaging and presence functionality for mobile devices and personal computers	Jabber for Windows: 11.6 Jabber for Mac: 11.5.2 Jabber for iPhone and iPad: 11.5 Jabber for Android: 11.5
Cisco DX Series	Personal TelePresence endpoint for the desktop	10.2(5.194)
Cisco TelePresence MX Series	TelePresence multipurpose room endpoint	CE8.1
Cisco TelePresence SX Series	Integrator Series TelePresence endpoint	CE8.1

Licensing Options

This table identifies the licensing options.

License Type	User Connect Licensing (UCL) Essential	User Connect Licensing (UCL) Basic	User Connect Licenses (UCL) Enhanced / Enhanced Plus	Unified Workspace Licensing (UWL) Standard	Unified Workspace Licensing (UWL) Professional
Number of User Profiles	1	1	1	1	1
Supported Device Type	Analog / Voice	Voice	Video	Video	Video
Number of Supported Devices	Single	Single	Single / Dual	Multiple ¹	Multiple ¹
Jabber IM and Presence²	Yes	Yes	Yes	Yes or WebEx	Yes or WebEx
Jabber Voice and Video Client	—	—	Yes	Yes	Yes
Personal Video Conference Bridge	—	—	—	Optional	Yes ³ , screen licenses for 25 users or more
Voice Messaging	Optional	Optional	Optional	Yes	Yes
WebEx Meetings	Optional	Optional	Optional	Optional	Yes, 1:10 Meeting Center ports
Contact Center	Optional	Optional	Optional	Optional	Yes, 1:25 Standard Express Agent
—	—	—	BE6K-UCL-ENH BE6K-UCL-ENHP	BE6K-UWL-BE	CUWL-PRO-K9 NEW-UWL-PRO

1. Cisco UWL enables the first 10 devices per user on installation. If more devices are required, contact licensing@cisco.com.

2. Available to all users when using the Cisco Unified Communications Manager IM and Presence Service on the BE6000M or BE6000H server. One-year WebEx Messenger subscriptions are available as an option for Cisco UWL users.

3. Cisco UWL Professional enables a Personal Multiparty License per user with the purchase of 25 or more Cisco UWL Professional licenses.



Americas Headquarters
Cisco Systems, Inc.
San Jose, CA

Asia Pacific Headquarters
Cisco Systems (USA) Pte. Ltd.
Singapore

Europe Headquarters
Cisco Systems International BV Amsterdam,
The Netherlands

Cisco has more than 200 offices worldwide. Addresses, phone numbers, and fax numbers are listed on the Cisco Website at www.cisco.com/go/offices.

Cisco and the Cisco Logo are trademarks of Cisco Systems, Inc. and/or its affiliates in the U.S. and other countries. A listing of Cisco's trademarks can be found at www.cisco.com/go/trademarks. Third party trademarks mentioned are the property of their respective owners. The use of the word partner does not imply a partnership relationship between Cisco and any other company. (1005R)