

CISCO VALIDATED DESIGN

# Intelligent WAN Configuration Files Guide

April 2017



# Table of Contents

Introduction .....	1
Product List .....	8
IWAN Dual Hybrid with PLR Design Model for EIGRP–WAN Aggregation .....	9
Configuration Files .....	12
IWAN Dual Hybrid with PLR Design Model for EIGRP–Remote Sites .....	13
Configuration Files.....	14
IWAN Dual Hybrid with PLR Design Model for BGP–WAN Aggregation .....	15
Configuration Files.....	18
IWAN Dual Hybrid with PLR Design Model for BGP–Remote Sites .....	19
Configuration Files.....	20
IWAN Dual Internet Design Model for EIGRP–WAN Aggregation .....	21
Configuration Files.....	23
IWAN Dual Internet Design Model for EIGRP–Remote Sites .....	24
Configuration Files.....	25
IWAN Hybrid with MTT Design Model for EIGRP–WAN Aggregation .....	26
Configuration Files.....	28
IWAN Hybrid with MTT Design Model for EIGRP–Remote Sites.....	29
Configuration Files.....	30
IWAN Dual Hybrid with PLR and MTT Design Model for BGP–WAN Aggregation .....	31
Configuration Files.....	33
IWAN Dual Hybrid with PLR and MTT Design Model for BGP–Remote Sites.....	34
Configuration Files.....	35
IWAN Dual Hybrid with PLR and Multi-VRF Design Model for BGP–WAN Aggregation .....	36
Configuration Files.....	39
IWAN Dual Hybrid with PLR and Multi-VRF Design Model for BGP–Remote Sites .....	40
Configuration Files.....	41
Appendix A: Changes.....	42

# Introduction

The Cisco Intelligent WAN (IWAN) solution provides design and implementation guidance for organizations looking to deploy wide area network (WAN) transport with a transport-independent design (TID), intelligent path control, application optimization, and secure encrypted communications between branch locations while reducing the operating cost of the WAN. IWAN takes full advantage of cost-effective transport services in order to increase bandwidth capacity without compromising performance, reliability, or security of collaboration or cloud-based applications.

This document provides the available configuration files for the products used in the [Intelligent WAN Deployment Guide](#) and the Intelligent WAN advanced series of guides.

The advanced guides are as follows:

- [IWAN High Availability and Scalability Deployment Guide](#)
- [IWAN Multiple Data Center Deployment Guide](#)
- [IWAN Multiple Transports Deployment Guide](#)
- [IWAN Multiple VRF Deployment Guide](#)
- [IWAN Public Key Infrastructure Deployment Guide](#)
- [IWAN NetFlow Monitoring Deployment Guide](#)
- [IWAN Remote Site 4G LTE Deployment Guide](#)

This guide is a companion document to the deployment guides, serving as a reference for engineers who are evaluating or deploying the IWAN solution.

This guide describes two base IWAN design models and three advanced IWAN design models.

The first design model is the IWAN Hybrid, which uses MPLS paired with Internet as WAN transports. In this design model, the MPLS WAN can provide more bandwidth for the critical classes of services needed for key applications and can provide SLA guarantees for these applications.

The second design model is the IWAN Dual Internet, which uses a pair of Internet service providers to further reduce cost while maintaining a high level of resiliency for the WAN.

Figure 1 IWAN hybrid model–WAN aggregation site overview

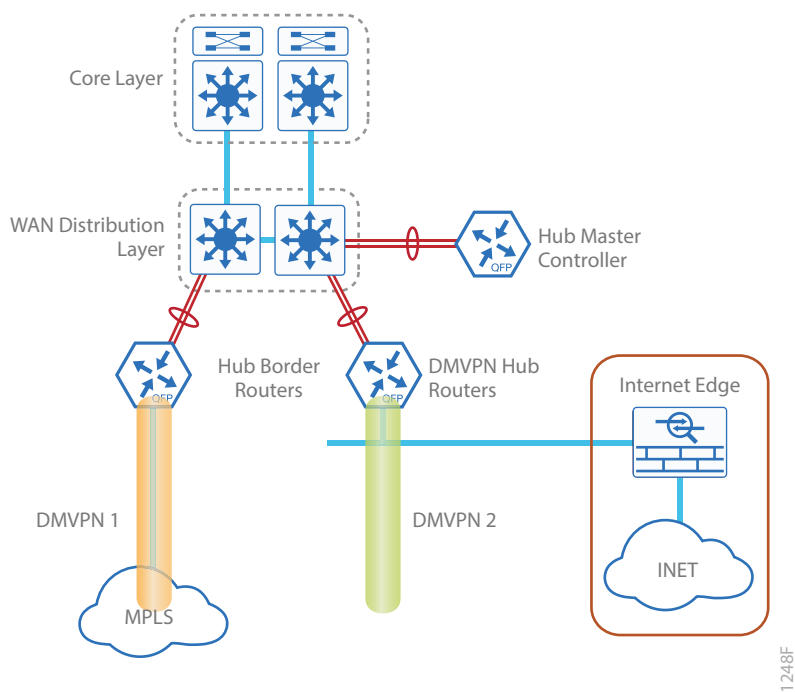

Figure 2 IWAN dual Internet model–WAN aggregation site overview

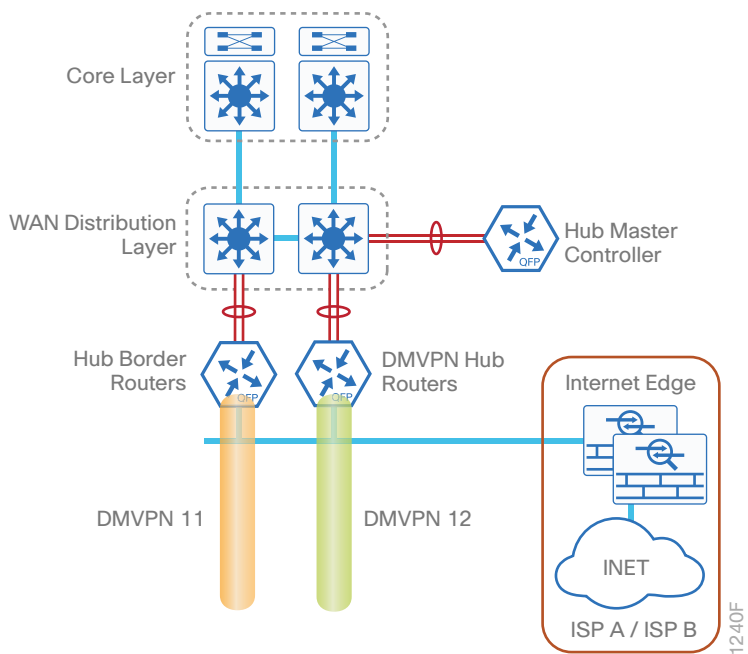
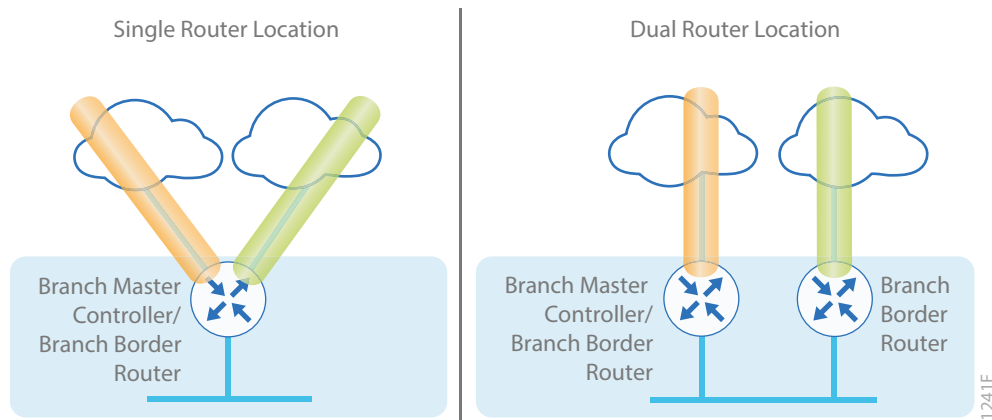

Figure 3 IWAN–Remote-site overview



The first advanced design builds on previous design models by adding hub border routers for horizontal scaling at a single data center. This design also has an option to add a second hub master controller (MC) at a single data center for high availability.

Figure 4 IWAN dual Internet Model–Hub MC high availability

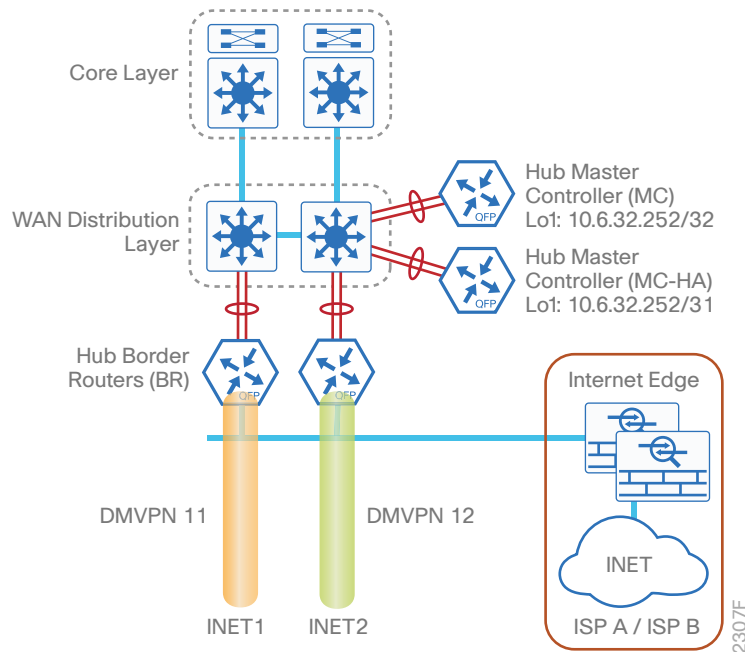
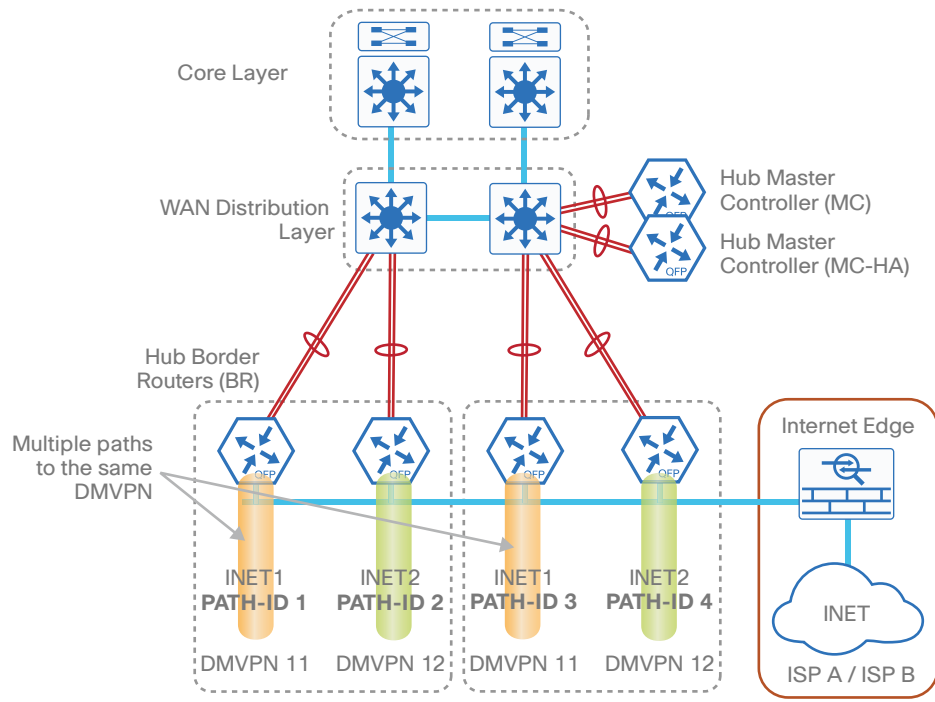

Figure 5 IWAN dual Internet model—Hub BR scalability



2308F

The second advanced design builds on previous design models with data center redundancy. The multi-data center or the transit site support feature enables organizations to scale their network infrastructure and load-balance the traffic when required.

Figure 6 IWAN hybrid model—Second data center as a transit site

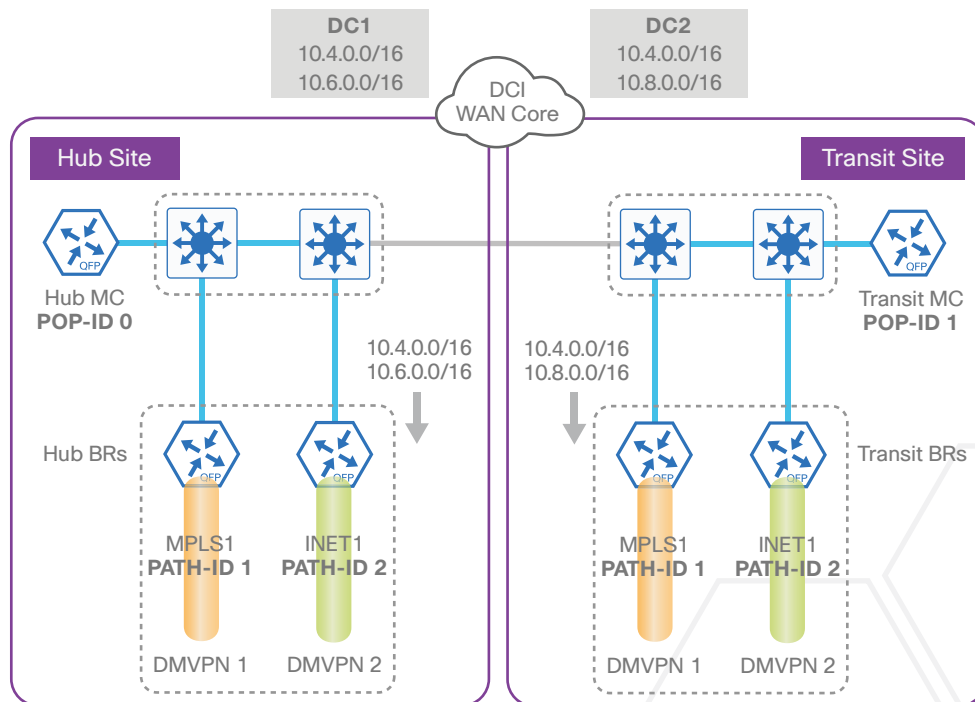

2309F

The third advanced design model is a multiple transport option called IWAN Dual Hybrid with Path of Last Resort (PLR). This model has two MPLS transports, two Internet transports, and a fifth transport used as the final option when the other four are not available. The model is not limited to two MPLS, two Internet and one PLR transport, but this specific design is used to show the underlying principles for multiple transports. The multiple transport design can be used with any of the previous design models.

You can add multiple WAN transports with new border routers or the Multiple Tunnel Termination (MTT) feature for each transport, depending on the scaling requirements.

**Figure 7** IWAN dual hybrid with PLR design model—WAN aggregation site overview

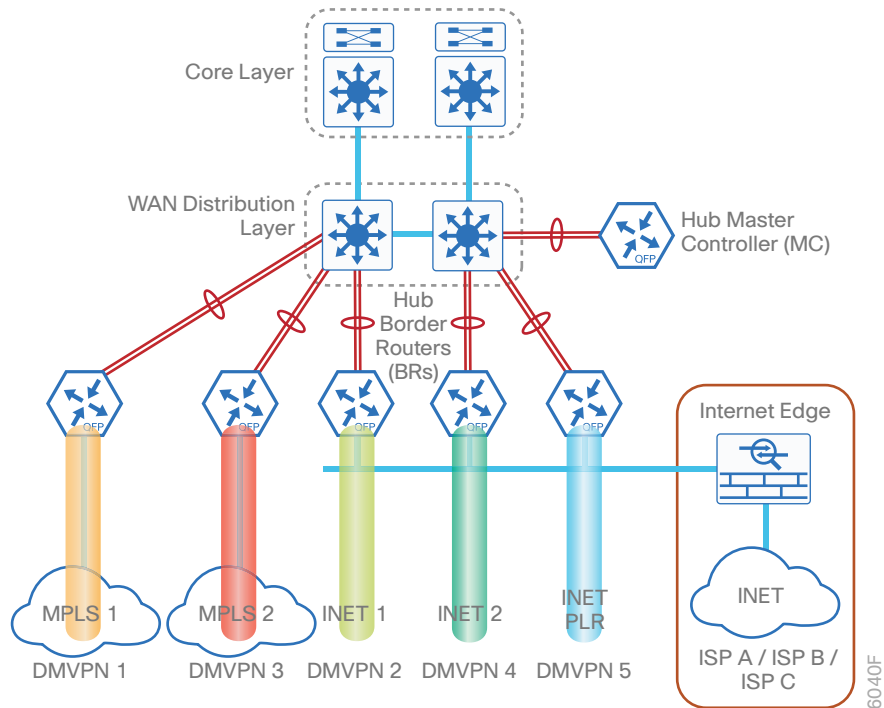
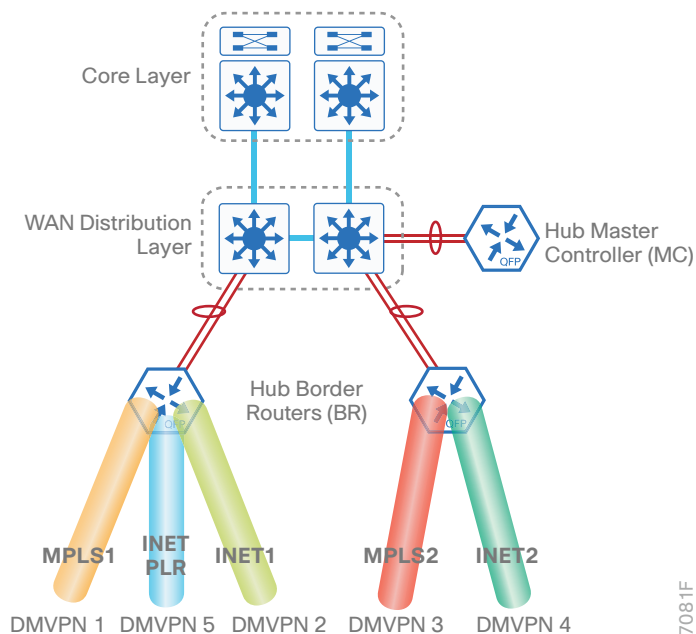
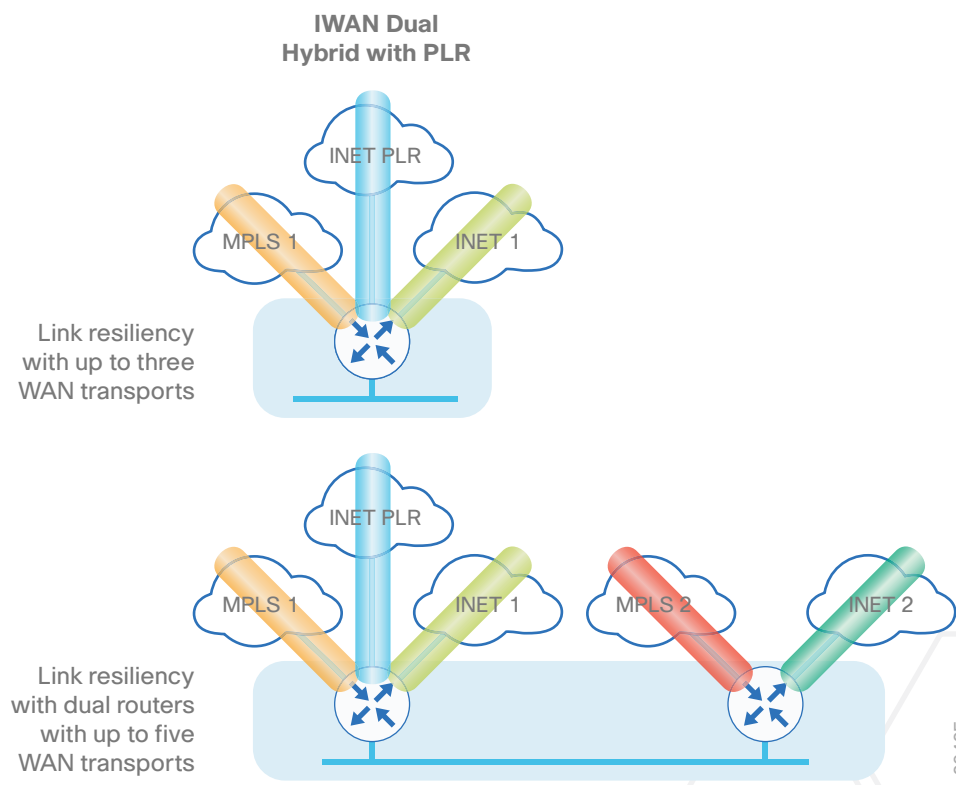

Figure 8 IWAN dual hybrid with PLR and MTT design model–WAN aggregation site overview



7081F

Figure 9 IWAN dual hybrid with PLR design model–Remote site options



6046F



The fourth advanced design model is a multiple transport option called IWAN Dual Hybrid with PLR and Multiple VRFs. This model adds virtual routing and forwarding instances for isolating end-to-end traffic among multiple independent networks inside the same data center (DC). Similarly, at the remote location, devices in each VRF co-exist inside the same physical hardware as the common employee network. The model is not limited to three VRFs, but this specific design is used to show the underlying principles for multiple VRFs. The multiple VRF design can be used with any of the previous design models.

The hub-site and transit-site are connected by a data center interconnect (DCI) link. Both sites are further connected to the remote sites over multiple WAN transports.

**Figure 10** IWAN dual hybrid with PLR and Multi-VRF design model

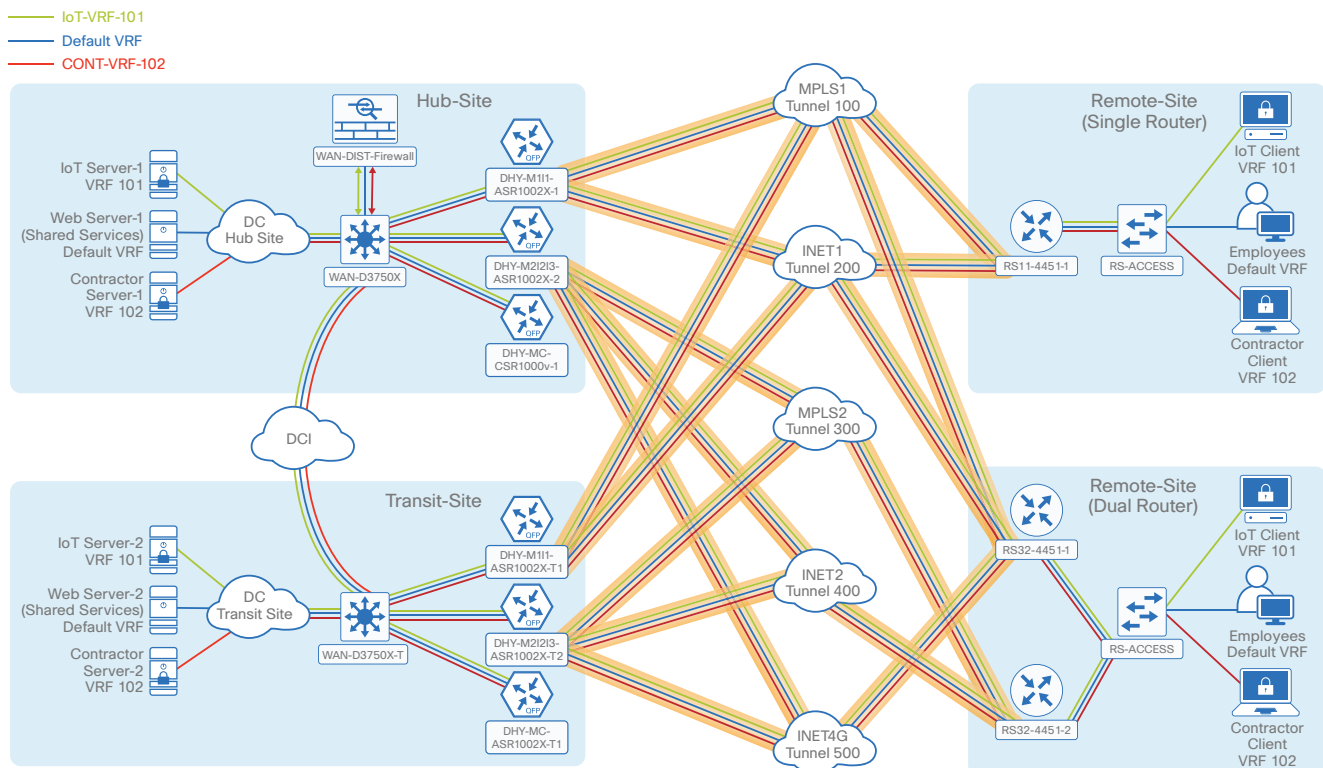

# Product List

To view the full list of IWAN-supported routers for this version of the CVD, see [Supported Cisco Platforms and Software Releases](#).

This guide was validated using the software in this appendix. When deploying, you should always use the Cisco IOS Software Checker tool to see if there are software vulnerabilities applicable for your environment. This tool is available at the following location:

<https://tools.cisco.com/security/center/selectIOSVersion.x>

# IWAN Dual Hybrid with PLR Design Model for EIGRP–WAN Aggregation

Performance Routing Version 3 (PfRv3) consists of two major Cisco IOS components: an MC and a border router (BR). The MC defines the policies and applies them to various traffic classes that traverse the BR systems. The MC can be configured to learn and control traffic classes on the network.

There are two different roles a device can play at the WAN aggregation site of a PfRv3 configuration:

- **Hub master controller**—The hub MC is the MC at the primary WAN aggregation site. This is the MC device where all PfRv3 policies are configured. It also acts as MC for that site and makes path-optimization decision. There is only one hub MC per IWAN domain.
- **Hub border router**—This is a BR at the hub MC site. This is the device where WAN interfaces terminate. There can be only one WAN interface on the device. There can be one or more hub BRs. On the Hub BRs, PfRv3 must be configured with:
  - The address of the local MC.
  - The path name on external interfaces.

This section also shows a second data center acting as a transit site with a transit MC and transit BRs.

- **Transit master controller**—The transit MC is the MC at the transit site. There is no policy configuration on this device. It receives policy from the hub MC. This device acts as MC for that site for making path optimization decisions. The configuration includes the IP address of the hub MC.
- **Transit border router**—This is a BR at the transit MC site. This is the device where WAN interfaces terminate. There can only be one WAN interface on the device. There can be one or more transit BRs. On the transit BRs, PfRv3 must be configured with:
  - The address of the transit MC.
  - The path name on external interfaces.
  - The path ID on external interfaces.

Finally, this section includes configuration files corresponding to the IWAN dual hybrid model with PLR using EIGRP, as referenced in the figure below.

Figure 11 IWAN dual hybrid model w/ PLR model for EIGRP

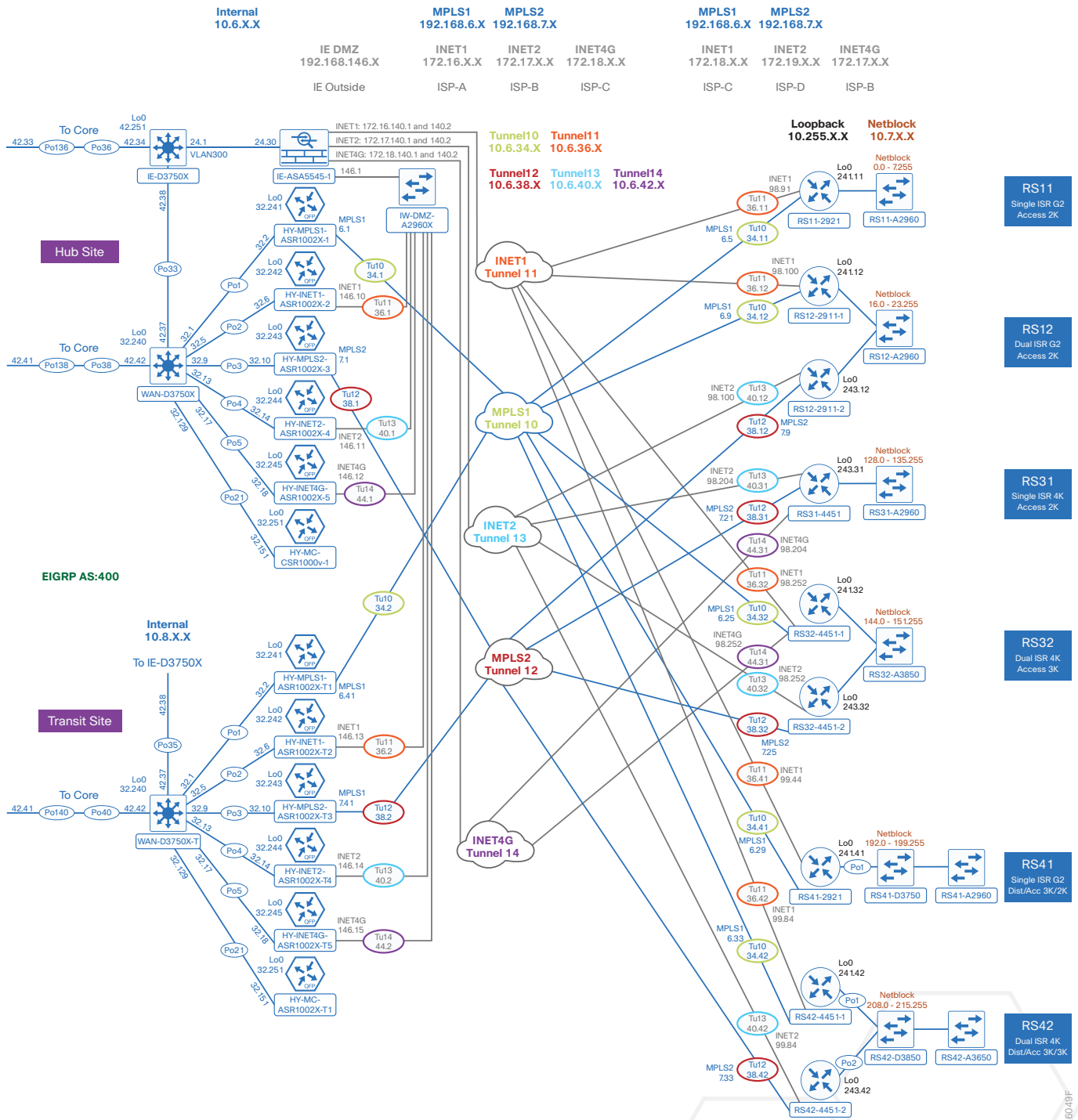

The following tables provide the loopback and port-channel IP addresses for the WAN aggregation devices in the IWAN dual hybrid with PLR design model.

**Table 1** IWAN dual hybrid with PLR model–Hub router IP addresses

IWAN function	Host name	Loopback IP address	Port channel IP address
Hub MC	DHY-MC-CSR1000V-1	10.6.32.251/32	10.6.32.151/26
Hub BR (MPLS1)	DHY-MPLS1-ASR1002X-1	10.6.32.241/32	10.6.32.2/30
Hub BR (INET1)	DHY-INET1-ASR1002X-2	10.6.32.242/32	10.6.32.6/30
Hub BR (MPLS2)	DHY-MPLS2-ASR1002X-3	10.6.32.243/32	10.6.32.10/30
Hub BR (INET2)	DHY-INET2-ASR1002X-4	10.6.32.244/32	10.6.32.14/30
Hub BR (PLR)	DHY-INET4G-ASR1002X-5	10.6.32.245/32	10.6.32.18/30

**Table 2** IWAN dual hybrid with PLR model–Transit router IP addresses

IWAN function	Host name	Loopback IP address	Port channel IP address
Transit MC	DHY-MC-ASR1002X-T1	10.8.32.251/32	10.8.32.151/26
Transit BR (MPLS1)	DHY-MPLS1-ASR1002X-T1	10.8.32.241/32	10.8.32.2/30
Transit BR (INET1)	DHY-INET1-ASR1002X-T2	10.8.32.242/32	10.8.32.6/30
Transit BR (MPLS2)	DHY-MPLS2-ASR1002X-T3	10.8.32.243/32	10.8.32.10/30
Transit BR (INET2)	DHY-INET2-ASR1002X-T4	10.8.32.244/32	10.8.32.14/30
Transit BR (PLR)	DHY-INET4G-ASR1002X-T5	10.8.32.245/32	10.8.32.18/30

## CONFIGURATION FILES

Below are the configuration files for all hub and transit site WAN aggregation–EIGRP:

- [The entire set](#)
- [DHY-MC-CSR1000V-1: Hub MC](#)
- [DHY-MPLS1-ASR1002X-1: Hub BR \(MPLS1\)](#)
- [DHY-INET1-ASR1002X-2: Hub BR \(INET1\)](#)
- [DHY-MPLS2-ASR1002X-3: Hub BR \(MPLS2\)](#)
- [DHY-INET2-ASR1002X-4: Hub BR \(INET2\)](#)
- [DHY-INET4G-ASR1002X-5: Hub BR \(PLR\)](#)
- [DHY-MC-ASR1002X-T1: Transit MC](#)
- [DHY-MPLS1-ASR1002X-T1: Transit BR \(MPLS1\)](#)
- [DHY-INET1-ASR1002X-T2: Transit BR \(INET1\)](#)
- [DHY-MPLS2-ASR1002X-T3: Transit BR \(MPLS2\)](#)
- [DHY-INET2-ASR1002X-T4: Transit BR \(INET2\)](#)
- [DHY-INET4G-ASR1002X-T5: Transit BR \(PLR\)](#)
- [IW-IE-ASA5545X: Firewall](#)

# IWAN Dual Hybrid with PLR Design Model for EIGRP–Remote Sites

Performance Routing Version 3 consists of two major Cisco IOS components: an MC and a BR. The MC defines the policies and applies them to various traffic classes that traverse the BR systems. The MC can be configured to learn and control traffic classes on the network.

There are two different roles a device can play at the remote site of a Pfrv3 configuration:

- **Branch master controller**—The Branch MC is the MC at the branch-site. There is no policy configuration on this device. It receives policy from the Hub MC. This device acts as MC for that site for making path-optimization decision. The configuration includes the IP address of the hub MC.
- **Branch border router**—This is a BR at the branch-site. The configuration on this device enables BR functionality and includes the IP address of the site local MC. The WAN interface that terminates on the device is detected automatically.

The following tables provide the loopback IP addresses for the remote site devices in the IWAN dual hybrid with PLR design model.

**Table 3** *IWAN dual hybrid with PLR model—Remote site router IP addresses*

IWAN function	Host name	Loopback IP address
Branch MC/BR (MPLS1/INET1)	RS11-2921	10.255.241.11/32
Branch MC/BR (MPLS1/INET1)	RS12-2911-1	10.255.241.12/32
Branch BR (MPLS2/INET2)	RS12-2911-2	10.255.243.12/32
Branch MC/BR (MPLS2/INET2/ PLR)	RS31-4451	10.255.243.31/32
Branch MC/BR (MPLS1/INET1/PLR)	RS32-4451-1	10.255.241.32/32
Branch BR (MPLS2/INET2)	RS32-4451-2	10.255.243.32/32
Branch MC/BR (MPLS1/INET1)	RS41-2921	10.255.241.41/32
Branch MC/BR (MPLS1/INET1)	RS42-4451-1	10.255.241.42/32
Branch BR (MPLS2/INET2)	RS42-4451-2	10.255.243.42/32
Branch MC/BR (MPLS1/INET1/4G)	RS51-2921	10.255.241.51/32

## CONFIGURATION FILES

Below are links to the configuration files for all hybrid remote site devices using EIGRP:

- [The entire set](#)
- RS11—Single-Router, Two-Link, Access (MPLS1 and INET1):
  - [RS11-2921: MPLS1 and INET1 WAN links](#)
- RS12—Dual-Router, Four-Link, Access (MPLS1, MPLS2, INET1 and INET2):
  - [RS12-2911-1: MPLS1 and INET1 WAN links](#)
  - [RS12-2911-2: MPLS2 and INET2 WAN links](#)
- RS31—Single-Router, Three-Link, Access (MPLS2, INET2 and PLR):
  - [RS31-4451: MPLS2, INET2 and PLR WAN links](#)
- RS32—Dual-Router, Five-Link, Access (MPLS1, MPLS2, INET1, INET2 and PLR):
  - [RS32-4451-1: MPLS1, INET1 and PLR WAN links](#)
  - [RS32-4451-2: MPLS2 and INET2 WAN links](#)
- RS41—Single-Router, Two-Link, Distribution (MPLS1 and INET1):
  - [RS41-2921: MPLS1 and INET1 WAN links](#)
- RS42—Dual-Router, Four-Link, Distribution (MPLS1, MPLS2, INET1 and INET2):
  - [RS42-4451-1: MPLS1 and INET1 WAN links](#)
  - [RS42-4451-2: MPLS2 and INET2 WAN links](#)
- RS51—Single-Router, Three-Link, Access (MPLS1 and INET1 with LTE Fallback):
  - [RS51-2921: MPLS1, INET1 and PLR WAN links](#)



# IWAN Dual Hybrid with PLR Design Model for BGP–WAN Aggregation

Performance Routing Version 3 consists of two major Cisco IOS components: an MC and a BR. The MC defines the policies and applies them to various traffic classes that traverse the BR systems. The MC can be configured to learn and control traffic classes on the network.

There are two different roles a device can play at the WAN aggregation site of a PfRv3 configuration:

- **Hub master controller**—The hub MC is the MC at the primary WAN aggregation site. This is the MC device where all PfRv3 policies are configured. It also acts as MC for that site and makes path-optimization decision. There is only one hub MC per IWAN domain.
- **Hub border router**—This is a BR at the hub MC site. This is the device where WAN interfaces terminate. There can be only one WAN interface on the device. There can be one or more hub BRs. On the Hub BRs, PfRv3 must be configured with:
  - The address of the local MC.
  - The path name on external interfaces.

This section also shows a second data center acting as a transit site with a transit MC and transit BRs.

- **Transit master controller**—The transit MC is the MC at the transit site. There is no policy configuration on this device. It receives policy from the hub MC. This device acts as MC for that site for making path optimization decisions. The configuration includes the IP address of the hub MC.
- **Transit border router**—This is a BR at the transit MC site. This is the device where WAN interfaces terminate. There can only be one WAN interface on the device. There can be one or more transit BRs. On the transit BRs, PfRv3 must be configured with:
  - The address of the transit MC.
  - The path name on external interfaces.
  - The path ID on external interfaces.

Finally, this section includes configuration files corresponding to the IWAN dual hybrid model with PLR using BGP on the WAN and OSPF on the LAN, as referenced in the figure below.

Figure 12 IWAN dual hybrid with PLR model for BGP and OSPF

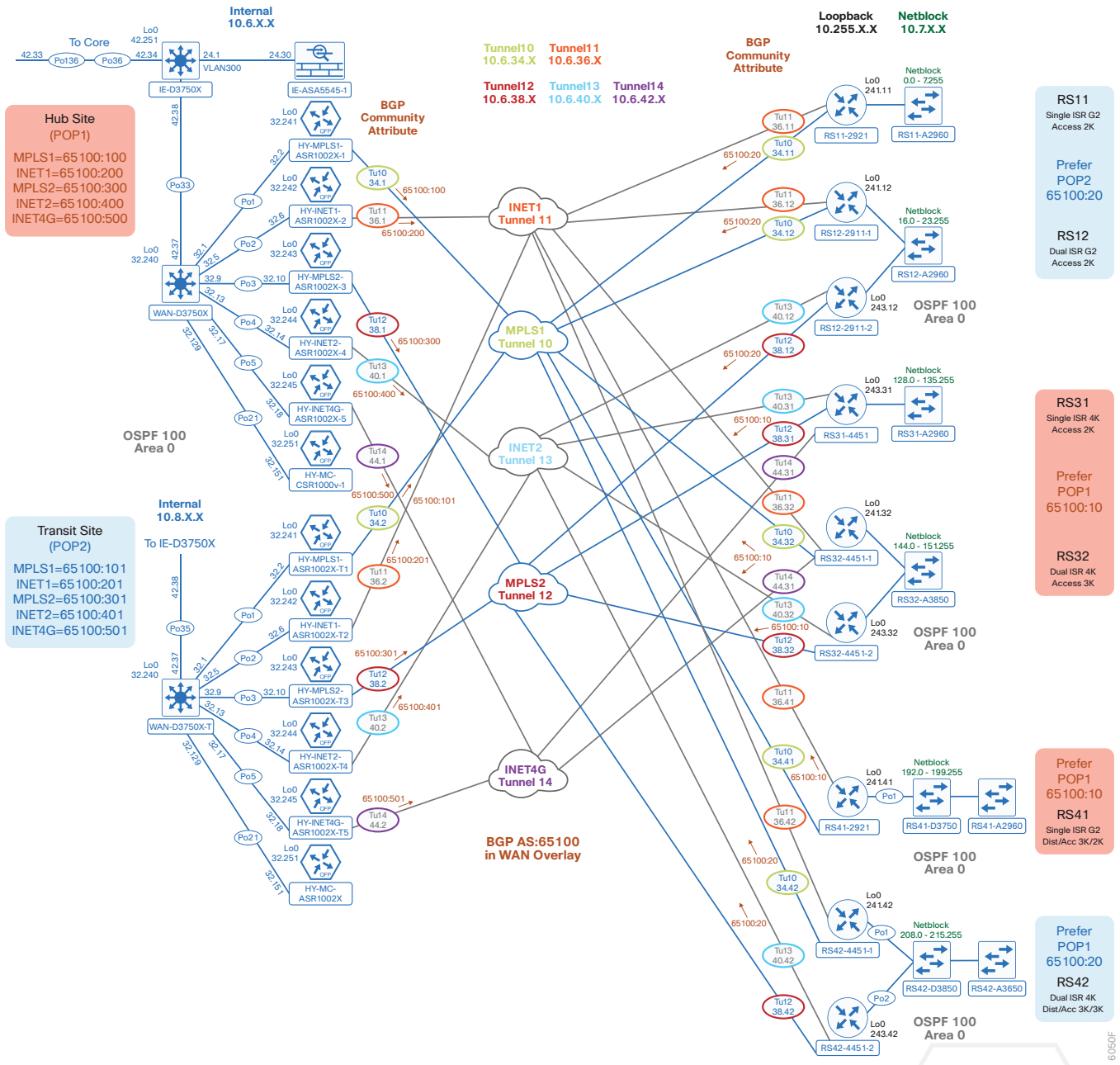

The following table provides the loopback and port-channel IP addresses for the WAN aggregation devices in the IWAN hybrid design model.

**Table 4** IWAN dual hybrid with PLR model–Hub router IP addresses

IWAN function	Host name	Loopback IP address	Port channel IP address
Hub MC	DHY-MC-CSR1000V-1	10.6.32.251/32	10.6.32.151/26
Hub BR (MPLS1)	DHY-MPLS1-ASR1002X-1	10.6.32.241/32	10.6.32.2/30
Hub BR (INET1)	DHY-INET1-ASR1002X-2	10.6.32.242/32	10.6.32.6/30
Hub BR (MPLS2)	DHY-MPLS2-ASR1002X-3	10.6.32.243/32	10.6.32.10/30
Hub BR (INET2)	DHY-INET2-ASR1002X-4	10.6.32.244/32	10.6.32.14/30
Hub BR (PLR)	DHY-INET4G-ASR1002X-5	10.6.32.245/32	10.6.32.18/30

**Table 5** IWAN dual hybrid with PLR model–Transit router IP addresses

IWAN function	Host name	Loopback IP address	Port channel IP address
Transit MC	DHY-MC-ASR1002X-T1	10.8.32.251/32	10.8.32.151/26
Transit BR (MPLS1)	DHY-MPLS1-ASR1002X-T1	10.8.32.241/32	10.8.32.2/30
Transit BR (INET1)	DHY-INET1-ASR1002X-T2	10.8.32.242/32	10.8.32.6/30
Transit BR (MPLS2)	DHY-MPLS2-ASR1002X-T3	10.8.32.243/32	10.8.32.10/30
Transit BR (INET2)	DHY-INET2-ASR1002X-T4	10.8.32.244/32	10.8.32.14/30
Transit BR (PLR)	DHY-INET4G-ASR1002X-T5	10.8.32.245/32	10.8.32.18/30

## CONFIGURATION FILES

Below are links to the configuration files for all hybrid hub and transit site WAN aggregation devices using BGP and OSPF:

- [The entire set](#)
- [DHY-MC-CSR1000V-1: Hub MC, BGP](#)
- [DHY-MPLS1-ASR1002X-1: Hub BR, BGP \(MPLS1\)](#)
- [DHY-INET1-ASR1002X-2: Hub BR, BGP \(INET1\)](#)
- [DHY-MPLS2-ASR1002X-3: Hub BR, BGP \(MPLS2\)](#)
- [DHY-INET2-ASR1002X-4: Hub BR, BGP \(INET2\)](#)
- [DHY-INET4G-ASR1002X-5: Hub BR, BGP \(PLR\)](#)
- [DHY-MC-ASR1002X-T1: Transit MC, BGP](#)
- [DHY-MPLS1-ASR1002X-T1: Transit BR, BGP \(MPLS1\)](#)
- [DHY-INET1-ASR1002X-T2: Transit BR, BGP \(INET1\)](#)
- [DHY-MPLS2-ASR1002X-T3: Transit BR, BGP \(MPLS2\)](#)
- [DHY-INET2-ASR1002X-T4: Transit BR, BGP \(INET2\)](#)
- [DHY-INET4G-ASR1002X-T5: Transit BR, BGP \(PLR\)](#)
- [IW-IE-ASA5545X: Firewall](#)

# IWAN Dual Hybrid with PLR Design Model for BGP–Remote Sites

Performance Routing Version 3 consists of two major Cisco IOS components: an MC and a BR. The MC defines the policies and applies them to various traffic classes that traverse the BR systems. The MC can be configured to learn and control traffic classes on the network.

There are two different roles a device can play at the remote site of a Pfrv3 configuration:

- **Branch master controller**—The Branch MC is the MC at the branch-site. There is no policy configuration on this device. It receives policy from the Hub MC. This device acts as MC for that site for making path-optimization decision. The configuration includes the IP address of the hub MC.
- **Branch border router**—This is a BR at the branch-site. The configuration on this device enables BR functionality and includes the IP address of the site local MC. The WAN interface that terminates on the device is detected automatically.

The following tables provide the loopback IP addresses for the remote site devices in the IWAN dual hybrid with PLR design model.

**Table 6** *IWAN dual hybrid with PLR model—Remote site router IP addresses*

IWAN function	Host name	Loopback IP address
Branch MC/BR (MPLS1/INET1)	RS11-2921	10.255.241.11/32
Branch MC/BR (MPLS1/INET1)	RS12-2911-1	10.255.241.12/32
Branch BR (MPLS2/INET2)	RS12-2911-2	10.255.243.12/32
Branch MC/BR (MPLS2/INET2/PLR)	RS31-4451	10.255.243.31/32
Branch MC/BR (MPLS1/INET1/PLR)	RS32-4451-1	10.255.241.32/32
Branch BR (MPLS2/INET2)	RS32-4451-2	10.255.243.32/32
Branch MC/BR (MPLS1/INET1)	RS41-2921	10.255.243.41/32
Branch MC/BR (MPLS1/INET1)	RS42-4451-1	10.255.241.42/32
Branch BR (MPLS2/INET2)	RS42-4451-2	10.255.243.42/32
Branch MC/BR (MPLS1/INET1/4G)	RS51-2921	10.255.241.51/32

## CONFIGURATION FILES

Below are links to the configuration files for all hybrid remote site devices using BGP and OSPF:

- [The entire set](#)
- RS11–Single-Router, Two-Link, Access, BGP (MPLS1 and INET1):
  - [RS11-2921: MPLS1 and INET1 WAN links](#)
- RS12–Dual-Router, Four-Link, Access, BGP (MPLS1, MPLS2, INET1 and INET2):
  - [RS12-2911-1: MPLS1 and INET1 WAN links](#)
  - [RS12-2911-2: MPLS2 and INET2 WAN links](#)
- RS31–Single-Router, Three-Link, Access, BGP (MPLS2, INET2 and PLR):
  - [RS31-4451: MPLS2, INET2 and PLR WAN links](#)
- RS32–Dual-Router, Five-Link, Access, BGP (MPLS1, MPLS2, INET1, INET2 and PLR):
  - [RS32-4451-1: MPLS1, INET1 and PLR WAN links](#)
  - [RS32-4451-2: MPLS2 and INET2 WAN links](#)
- RS41–Single-Router, Two-Link, Distribution, BGP (MPLS1 and INET1):
  - [RS41-2921: MPLS1 and INET1 WAN links](#)
- RS42–Dual-Router, Four-Link, Distribution, BGP (MPLS1, MPLS2, INET1 and INET2):
  - [RS42-4451-1: MPLS1 and INET1 WAN links](#)
  - [RS42-4451-2: MPLS2 and INET2 WAN links](#)
- RS51–Single-Router, Three-Link, Access, BGP (MPLS1 and INET1 with LTE Fallback):
  - [RS51-2921: MPLS1, INET1 and PLR WAN links](#)

# IWAN Dual Internet Design Model for EIGRP–WAN Aggregation

Performance Routing Version 3 consists of two major Cisco IOS components: an MC and a BR. The MC defines the policies and applies them to various traffic classes that traverse the BR systems. The MC can be configured to learn and control traffic classes on the network.

There are two different roles a device can play at the WAN aggregation site of a PfRv3 configuration:

- **Hub master controller**—The hub MC is the MC at the primary WAN aggregation site. This is the MC device where all PfRv3 policies are configured. It also acts as MC for that site and makes path-optimization decision. There is only one hub MC per IWAN domain.
- **Hub border router**—This is a BR at the hub MC site. This is the device where WAN interfaces terminate. There can be only one WAN interface on the device. There can be one or more hub BRs. On the Hub BRs, PfRv3 must be configured with:
  - The address of the local MC.
  - The path name on external interfaces.

This version of the guide also has hub MC HA and hub BR scaling.



This section includes configuration files corresponding to the IWAN dual Internet design model WAN aggregation site for EIGRP, as referenced in the figure below.

Figure 13 IWAN dual Internet model for EIGRP–Hub MC HA, hub BR scaling and IOS CA

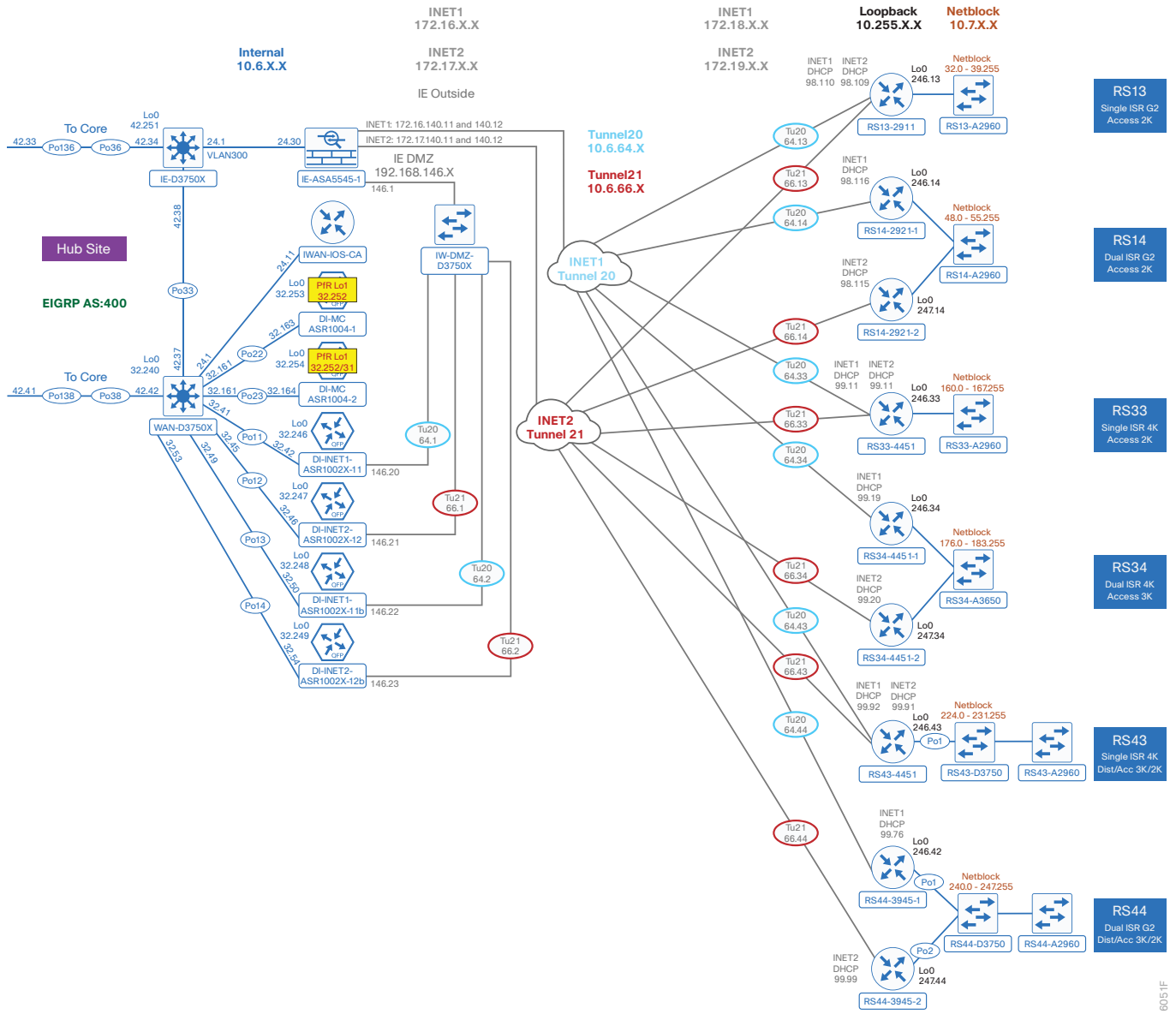

6051F



The following table provides the loopback addresses for the WAN aggregation devices in the IWAN dual Internet model.

**Table 7** *IWAN dual Internet model–Hub router IP addresses*

IWAN function	Host name	Loopback0 IP address (Mgmt)	Loopback1 IP address (PfR)	Port channel IP address
Hub MC	DI-MC-ASR1004-1	10.6.32.253/32	10.6.32.252/32	10.6.32.163/26
Hub MC HA	DI-MC-ASR1004-2	10.6.32.254/32	10.6.32.252/31	10.6.32.164/26
Hub BR (INET1)	DI-INET1-ASR1002X-11	10.6.32.246/32	N/A	10.6.32.42/30
Hub BR (INET2)	DI-INET1-ASR1002X-12	10.6.32.247/32	N/A	10.6.32.46/30
Hub BR2 (INET1)	DI-INET1-ASR1002X-11b	10.6.32.248/32	N/A	10.6.32.50/30
Hub BR2 (INET2)	DI-INET1-ASR1002X-12b	10.6.32.249/32	N/A	10.6.32.54/30

## CONFIGURATION FILES

Below are links to the configuration files for all dual Internet hub site WAN aggregation devices using EIGRP:

- [The entire set](#)
- [DI-MC-ASR1004-1: Hub MC](#)
- [DI-MC-ASR1004-2: Hub MC HA](#)
- [DI-INET1-ASR1002X-11: Hub BR \(INET1\)](#)
- [DI-INET1-ASR1002X-12: Hub BR \(INET2\)](#)
- [DI-INET1-ASR1002X-11b: Hub BR2 \(INET1\)](#)
- [DI-INET1-ASR1002X-12b: Hub BR2 \(INET2\)](#)
- [IWAN-IOS-CA: IOS Certificate Authority](#)
- [IW-IE-ASA5545X: Firewall](#)

# IWAN Dual Internet Design Model for EIGRP–Remote Sites

Performance Routing Version 3 consists of two major Cisco IOS components: an MC and a BR. The MC defines the policies and applies them to various traffic classes that traverse the BR systems. The MC can be configured to learn and control traffic classes on the network.

There are two different roles a device can play at the remote site of a Pfrv3 configuration:

- **Branch master controller**—The Branch MC is the MC at the branch-site. There is no policy configuration on this device. It receives policy from the Hub MC. This device acts as MC for that site for making path-optimization decision. The configuration includes the IP address of the hub MC.
- **Branch border router**—This is a BR at the branch-site. The configuration on this device enables BR functionality and includes the IP address of the site local MC. The WAN interface that terminates on the device is detected automatically.

The following table provides the loopback addresses for the remote site devices in the IWAN dual Internet design model.

**Table 8** IWAN dual Internet model—Remote site router IP addresses

IWAN function	Host name	Loopback IP address
Branch MC/BR (INET1/INET2)	RS13-2911	10.255.246.13/32
Branch MC/BR (INET1)	RS14-2921-1	10.255.246.14/32
Branch BR (INET2)	RS14-2921-2	10.255.247.14/32
Branch MC/BR (INET1/INET2)	RS33-4451	10.255.246.33/32
Branch MC/BR (INET1)	RS34-4451-1	10.255.246.34/32
Branch BR (INET2)	RS34-4451-2	10.255.247.34/32
Branch MC/BR (INET1/INET2)	RS43-4451	10.255.246.43/32
Branch MC/BR (INET1)	RS44-3945-1	10.255.246.44/32
Branch BR (INET2)	RS44-3945-2	10.255.247.44/32

## CONFIGURATION FILES

Below are links to the configuration files for all dual Internet remote site devices using EIGRP:

- [The entire set](#)
- RS13—Single-Router, Two-Link, Access (INET1 and INET2):
  - [RS13-2911: INET1 and INET2 WAN links](#)
- RS14—Dual-Router, Two-Link, Access (INET1 and INET2):
  - [RS14-2921-1: INET1 WAN link](#)
  - [RS14-2921-2: INET2 WAN link](#)
- RS33—Single-Router, Two-Link, Access (INET1 and INET2):
  - [RS33-4451: INET1 and INET2 WAN links](#)
- RS34—Dual-Router, Two-Link, Access (INET1 and INET2):
  - [RS34-4451-1: INET1 WAN link](#)
  - [RS34-4451-2: INET2 WAN link](#)
- RS43—Single-Router, Two-Link, Distribution (INET1 and INET2):
  - [RS43-4451: INET1 and INET2 WAN links](#)
- RS44—Dual-Router, Two-Link, Distribution (INET1 and INET2):
  - [RS44-3945-1: INET1 WAN link](#)
  - [RS44-3945-2: INET2 WAN link](#)



# IWAN Hybrid with MTT Design Model for EIGRP–WAN Aggregation

Performance Routing Version 3 consists of two major Cisco IOS components: an MC and a BR. The MC defines the policies and applies them to various traffic classes that traverse the BR systems. The MC can be configured to learn and control traffic classes on the network.

There are two different roles a device can play at the WAN aggregation site of a PfRv3 configuration:

- **Hub master controller**—The hub MC is the MC at the primary WAN aggregation site. This is the MC device where all PfRv3 policies are configured. It also acts as MC for that site and makes path-optimization decision. There is only one hub MC per IWAN domain.
- **Hub border router**—This is a BR at the hub MC site. This is the device where WAN interfaces terminate. There can be only one WAN interface on the device. There can be one or more hub BRs. On the Hub BRs, PfRv3 must be configured with:
  - The address of the local MC.
  - The path name on external interfaces.

This version of the guide also has MTT, hub MC HA, hub BR scaling and IOS CA.



This section includes configuration files corresponding to the IWAN hybrid design model WAN aggregation site for EIGRP, as referenced in the figure below.

Figure 14 IWAN hybrid with MTT design model for EIGRP-Hub MC HA, hub BR scaling and IOS CA

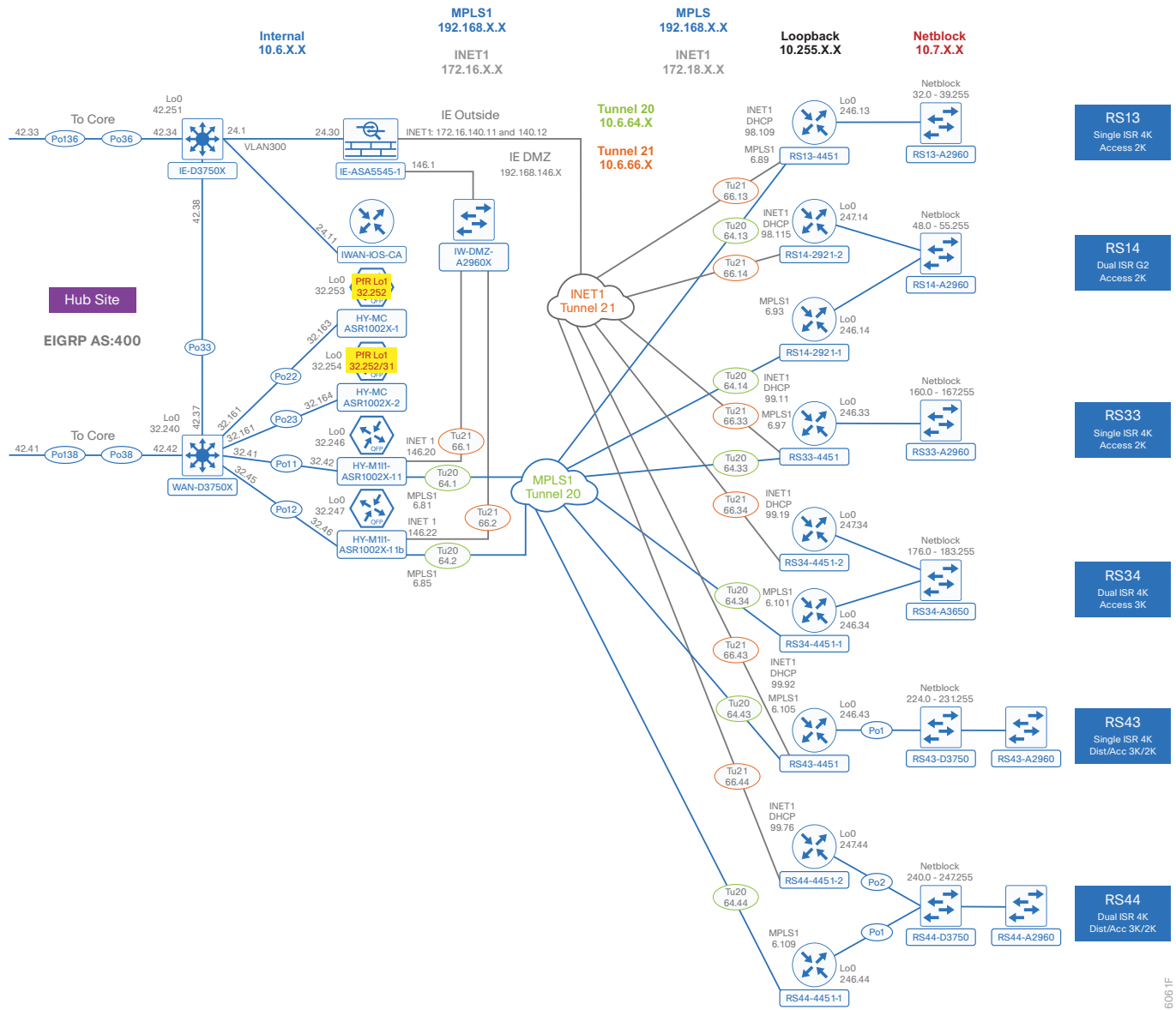

606 1F

The following table provides the loopback addresses for the WAN aggregation devices in the IWAN hybrid model.

**Table 9** *IWAN hybrid with MTT model–Hub router IP addresses*

IWAN function	Host name	Loopback0 IP address (Mgmt)	Loopback1 IP address (PfR)	Port channel IP address
Hub MC	HY-MC-ASR1002X-1	10.6.32.253/32	10.6.32.252/32	10.6.32.163/26
Hub MC HA	HY-MC-ASR1002X-1	10.6.32.254/32	10.6.32.252/31	10.6.32.164/26
Hub BR (MPLS1 & INET1)	HY-M111-ASR1002X-11	10.6.32.246/32	N/A	10.6.32.42/30
Hub BR (MPLS1 & INET1)	HY-M111-ASR1002X-11b	10.6.32.247/32	N/A	10.6.32.46/30

## CONFIGURATION FILES

Below are links to the configuration files for all hybrid with MTT hub site WAN aggregation devices using EIGRP:

- [The entire set](#)
- [HY-MC-ASR1002X-1: Hub MC](#)
- [HY-MC-ASR1002X-2: Hub MC HA](#)
- [HY-M111-ASR1002X-11: Hub BR \(MPLS1 & INET1\)](#)
- [HY-M111-ASR1002X-11b: Hub BR \(MPLS1 & INET1\)](#)
- [IWAN-IOS-CA: IOS Certificate Authority](#)
- [IW-IE-ASA5545X: Firewall](#)

# IWAN Hybrid with MTT Design Model for EIGRP–Remote Sites

Performance Routing Version 3 consists of two major Cisco IOS components: an MC and a BR. The MC defines the policies and applies them to various traffic classes that traverse the BR systems. The MC can be configured to learn and control traffic classes on the network.

There are two different roles a device can play at the remote site of a Pfrv3 configuration:

- **Branch master controller**—The Branch MC is the MC at the branch-site. There is no policy configuration on this device. It receives policy from the Hub MC. This device acts as MC for that site for making path-optimization decision. The configuration includes the IP address of the hub MC.
- **Branch border router**—This is a BR at the branch-site. The configuration on this device enables BR functionality and includes the IP address of the site local MC. The WAN interface that terminates on the device is detected automatically.

The following table provides the loopback addresses for the remote site devices in the IWAN hybrid with MTT design model.

**Table 10** *IWAN hybrid with MTT model—Remote site router IP addresses*

IWAN function	Host name	Loopback IP address
Branch MC/BR (MPLS1/INET1)	RS13-4451	10.255.246.13/32
Branch MC/BR (MPLS1)	RS14-2921-1	10.255.246.14/32
Branch BR (INET1)	RS14-2921-2	10.255.247.14/32
Branch MC/BR (MPLS1/INET1)	RS33-4451	10.255.246.33/32
Branch MC/BR (MPLS1)	RS34-4451-1	10.255.246.34/32
Branch BR (INET1)	RS34-4451-2	10.255.247.34/32
Branch MC/BR (MPLS1/INET1)	RS43-4451	10.255.246.43/32
Branch MC/BR (MPLS1)	RS44-4451-1	10.255.246.44/32
Branch BR (INET1)	RS44-4451-2	10.255.247.44/32

## CONFIGURATION FILES

Below are links to the configuration files for all hybrid with MTT remote site devices using EIGRP:

- [The entire set](#)
- RS13–Single-Router, Two-Link, Access (MPLS1 and INET1):
  - [RS13-4451: MPLS1 and INET1 WAN links](#)
- RS14–Dual-Router, Two-Link, Access (MPLS1 and INET1):
  - [RS14-2921-1: MPLS1 WAN link](#)
  - [RS14-2921-2: INET1 WAN link](#)
- RS33–Single-Router, Two-Link, Access (MPLS1 and INET1):
  - [RS33-4451: MPLS1 and INET1 WAN links](#)
- RS34–Dual-Router, Two-Link, Access (MPLS1 and INET1):
  - [RS34-4451-1: MPLS1 WAN link](#)
  - [RS34-4451-2: INET1 WAN link](#)
- RS43–Single-Router, Two-Link, Distribution (MPLS1 and INET1):
  - [RS43-4451: MPLS1 and INET1 WAN links](#)
- RS44–Dual-Router, Two-Link, Distribution (MPLS1 and INET1):
  - [RS44-4451-1: MPLS1 WAN link](#)
  - [RS44-4451-2: INET1 WAN link](#)



# IWAN Dual Hybrid with PLR and MTT Design Model for BGP–WAN Aggregation

Performance Routing Version 3 consists of two major Cisco IOS components: an MC and a BR. The MC defines the policies and applies them to various traffic classes that traverse the BR systems. The MC can be configured to learn and control traffic classes on the network.

There are two different roles a device can play at the WAN aggregation site of a PfRv3 configuration:

- **Hub master controller**—The hub MC is the MC at the primary WAN aggregation site. This is the MC device where all PfRv3 policies are configured. It also acts as MC for that site and makes path-optimization decision. There is only one hub MC per IWAN domain.
- **Hub border router**—This is a BR at the hub MC site. This is the device where WAN interfaces terminate. There can be only one WAN interface on the device. There can be one or more hub BRs. On the Hub BRs, PfRv3 must be configured with:
  - The address of the local MC.
  - The path name on external interfaces.

This section also shows a second data center acting as a transit site with a transit MC and transit BRs.

- **Transit master controller**—The transit MC is the MC at the transit site. There is no policy configuration on this device. It receives policy from the hub MC. This device acts as MC for that site for making path optimization decisions. The configuration includes the IP address of the hub MC.
- **Transit border router**—This is a BR at the transit MC site. This is the device where WAN interfaces terminate. There can only be one WAN interface on the device. There can be one or more transit BRs. On the transit BRs, PfRv3 must be configured with:
  - The address of the transit MC.
  - The path name on external interfaces.
  - The path ID on external interfaces.



Finally, this section includes configuration files corresponding to the IWAN dual hybrid model with PLR and MTT using BGP on the WAN and OSPF on the LAN, as referenced in the figure below.

Figure 15 IWAN dual hybrid with PLR and MTT model for BGP and OSPF

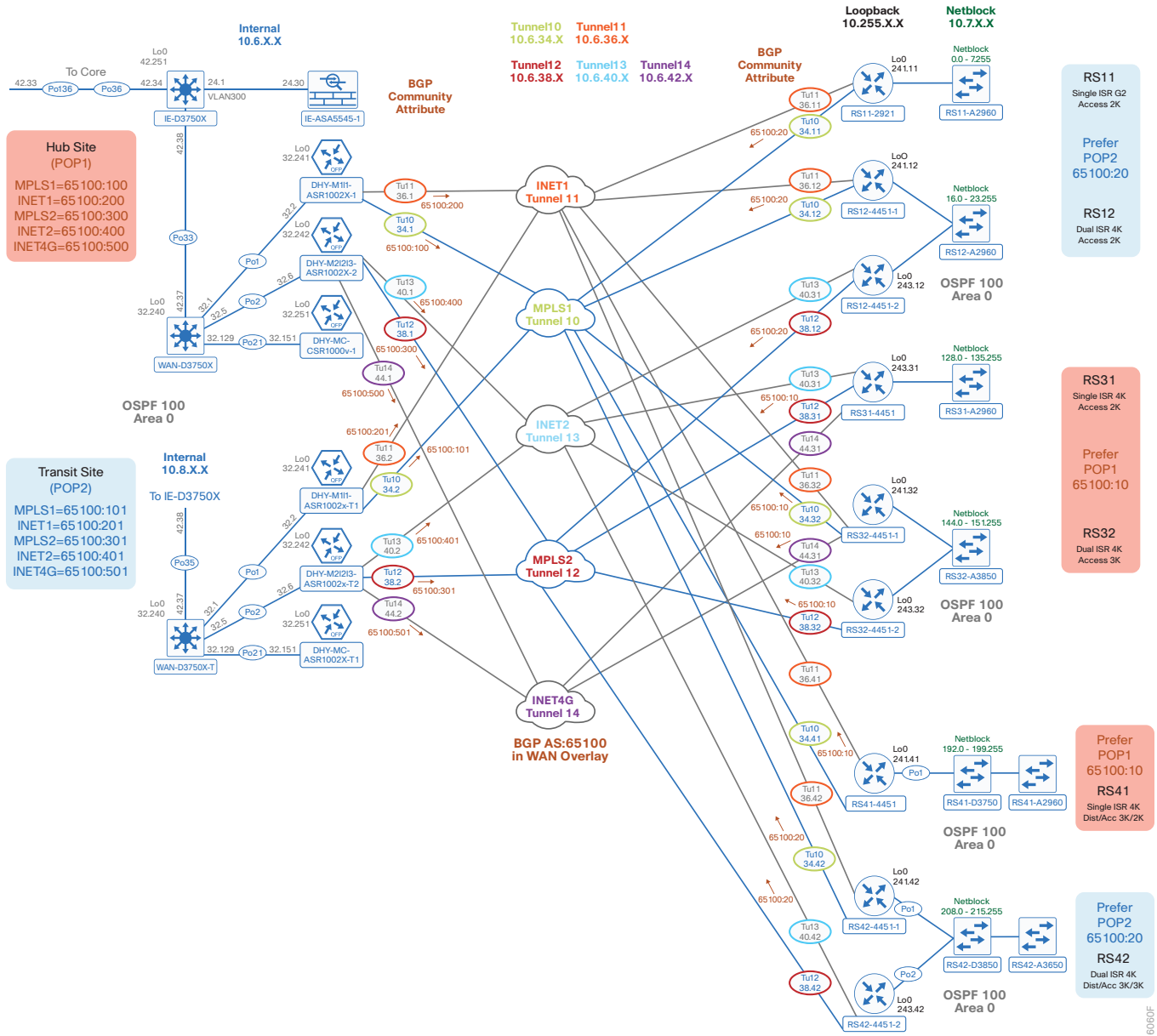

6060F

The following table provides the loopback and port-channel IP addresses for the WAN aggregation devices in the IWAN dual hybrid with PLR and MTT design model.

**Table 11** IWAN dual hybrid with PLR and MTT model–Hub router IP addresses

IWAN function	Host name	Loopback IP address	Port channel IP address
Hub MC	DHY-MC-CSR1000V-1	10.6.32.251/32	10.6.32.151/26
Hub BR (MPLS1 & INET1)	DHY-M1I1-ASR1002X-1	10.6.32.241/32	10.6.32.2/30
Hub BR (MPLS2, INET2 and PLR)	DHY-M2I2I3-ASR1002X-2	10.6.32.242/32	10.6.32.6/30

**Table 12** IWAN dual hybrid with PLR and MTT model–Transit router IP addresses

IWAN function	Host name	Loopback IP address	Port channel IP address
Transit MC	DHY-MC-ASR1002X-T1	10.8.32.251/32	10.8.32.151/26
Transit BR (MPLS1 & INET1)	DHY-M1I1-ASR1002X-T1	10.8.32.241/32	10.8.32.2/30
Transit BR (MPLS2, INET2 and PLR)	DHY-M2I2I3-ASR1002X-T2	10.8.32.242/32	10.8.32.6/30

## CONFIGURATION FILES

Below are links to the configuration files for all dual hybrid with PLR and MTT hub and transit site WAN aggregation devices using BGP and OSPF:

- [The entire set](#)
- [DHY-MC-CSR1000V-1: Hub MC, BGP](#)
- [DHY-M1I1-ASR1002X-1: Hub BR, BGP \(MPLS1 & INET1\)](#)
- [DHY-M2I2I3-ASR1002X-2: Hub BR, BGP \(MPLS2, INET2 & PLR\)](#)
- [DHY-MC-ASR1002X-T1: Transit MC, BGP](#)
- [DHY-M1I1-ASR1002X-T1: Transit BR, BGP \(MPLS1 & INET1\)](#)
- [DHY-M2I2I3-ASR1002X-T2: Transit BR, BGP \(MPLS2, INET2 & PLR\)](#)
- [IW-WAN-D3750X: Hub WAN Agg Distribution Switch](#)
- [IW-WAN-D3750X-T: Transit WAN Agg Distribution Switch](#)
- [IW-IE-ASA5545X: Firewall](#)

# IWAN Dual Hybrid with PLR and MTT Design Model for BGP–Remote Sites

Performance Routing Version 3 consists of two major Cisco IOS components: an MC and a BR. The MC defines the policies and applies them to various traffic classes that traverse the BR systems. The MC can be configured to learn and control traffic classes on the network.

There are two different roles a device can play at the remote site of a Pfrv3 configuration:

- **Branch master controller**—The Branch MC is the MC at the branch-site. There is no policy configuration on this device. It receives policy from the Hub MC. This device acts as MC for that site for making path-optimization decision. The configuration includes the IP address of the hub MC.
- **Branch border router**—This is a BR at the branch-site. The configuration on this device enables BR functionality and includes the IP address of the site local MC. The WAN interface that terminates on the device is detected automatically.

The following tables provide the loopback IP addresses for the remote site devices in the IWAN dual hybrid with PLR and MTT design model.

**Table 13** *IWAN dual hybrid with PLR and MTT model—Remote site router IP addresses*

IWAN function	Host name	Loopback IP address
Branch MC/BR (MPLS1/INET1)	RS11-2921	10.255.241.11/32
Branch MC/BR (MPLS1/INET1)	RS12-4451-1	10.255.241.12/32
Branch BR (MPLS2/INET2)	RS12-4451-2	10.255.243.12/32
Branch MC/BR (MPLS2/INET2/PLR)	RS31-4451	10.255.243.31/32
Branch MC/BR (MPLS1/INET1/PLR)	RS32-4451-1	10.255.241.32/32
Branch BR (MPLS2/INET2)	RS32-4451-2	10.255.243.32/32
Branch MC/BR (MPLS1/INET1)	RS41-4451	10.255.243.41/32
Branch MC/BR (MPLS1/INET1)	RS42-4451-1	10.255.241.42/32
Branch BR (MPLS2/INET2)	RS42-4451-2	10.255.243.42/32
Branch MC/BR (MPLS1/INET1/4G)	RS51-2921	10.255.241.51/32

## CONFIGURATION FILES

Below are links to the configuration files for all dual hybrid with PLR and MTT remote site devices using BGP and OSPF:

- [The entire set](#)
- RS11–Single-Router, Two-Link, Access, BGP (MPLS1 and INET1):
  - [RS11-2921: MPLS1 and INET1 WAN links](#)
- RS12–Dual-Router, Four-Link, Access, BGP (MPLS1, MPLS2, INET1 and INET2):
  - [RS12-4451-1: MPLS1 and INET1 WAN links](#)
  - [RS12-4451-2: MPLS2 and INET2 WAN links](#)
- RS31–Single-Router, Three-Link, Access, BGP (MPLS2, INET2 and PLR):
  - [RS31-4451: MPLS2, INET2 and PLR WAN links](#)
- RS32–Dual-Router, Five-Link, Access, BGP (MPLS1, MPLS2, INET1, INET2 and PLR):
  - [RS32-4451-1: MPLS1, INET1 and PLR WAN links](#)
  - [RS32-4451-2: MPLS2 and INET2 WAN links](#)
- RS41–Single-Router, Two-Link, Distribution, BGP (MPLS1 and INET1):
  - [RS41-4451: MPLS1 and INET1 WAN links](#)
- RS42–Dual-Router, Four-Link, Distribution, BGP (MPLS1, MPLS2, INET1 and INET2):
  - [RS42-4451-1: MPLS1 and INET1 WAN links](#)
  - [RS42-4451-2: MPLS2 and INET2 WAN links](#)
- RS51–Single-Router, Three-Link, Access, BGP (MPLS1 and INET1 with LTE Fallback):
  - [RS51-2921: MPLS1, INET1 and PLR WAN links](#)

# IWAN Dual Hybrid with PLR and Multi-VRF Design Model for BGP-WAN Aggregation

Performance Routing Version 3 consists of two major Cisco IOS components: an MC and a BR. The MC defines the policies and applies them to various traffic classes that traverse the BR systems. The MC can be configured to learn and control traffic classes on the network.

There are two different roles a device can play at the WAN aggregation site of a PfRv3 configuration:

- **Hub master controller**—The hub MC is the MC at the primary WAN aggregation site. This is the MC device where all PfRv3 policies are configured. It also acts as MC for that site and makes path-optimization decision. There is only one hub MC per IWAN domain.
- **Hub border router**—This is a BR at the hub MC site. This is the device where WAN interfaces terminate. There can be only one WAN interface on the device. There can be one or more hub BRs. On the Hub BRs, PfRv3 must be configured with:
  - The address of the local MC.
  - The path name on external interfaces.

This section also shows a second data center acting as a transit site with a transit MC and transit BRs.

- **Transit master controller**—The transit MC is the MC at the transit site. There is no policy configuration on this device. It receives policy from the hub MC. This device acts as MC for that site for making path optimization decisions. The configuration includes the IP address of the hub MC.
- **Transit border router**—This is a BR at the transit MC site. This is the device where WAN interfaces terminate. There can only be one WAN interface on the device. There can be one or more transit BRs. On the transit BRs, PfRv3 must be configured with:
  - The address of the transit MC.
  - The path name on external interfaces.
  - The path ID on external interfaces.

In order to enable inter-VRF route leaking, a Cisco firewall is configured with static routes. It is attached to the hub-site WAN distribution switch, and a very basic configuration is included here as a reference only.



Finally, this section includes configuration files corresponding to the IWAN dual hybrid model with PLR and Multi-VRF using BGP on the WAN and OSPF on the LAN, as referenced in the figure below.

Figure 16 IWAN dual hybrid with PLR and Multi-VRF model for BGP and OSPF

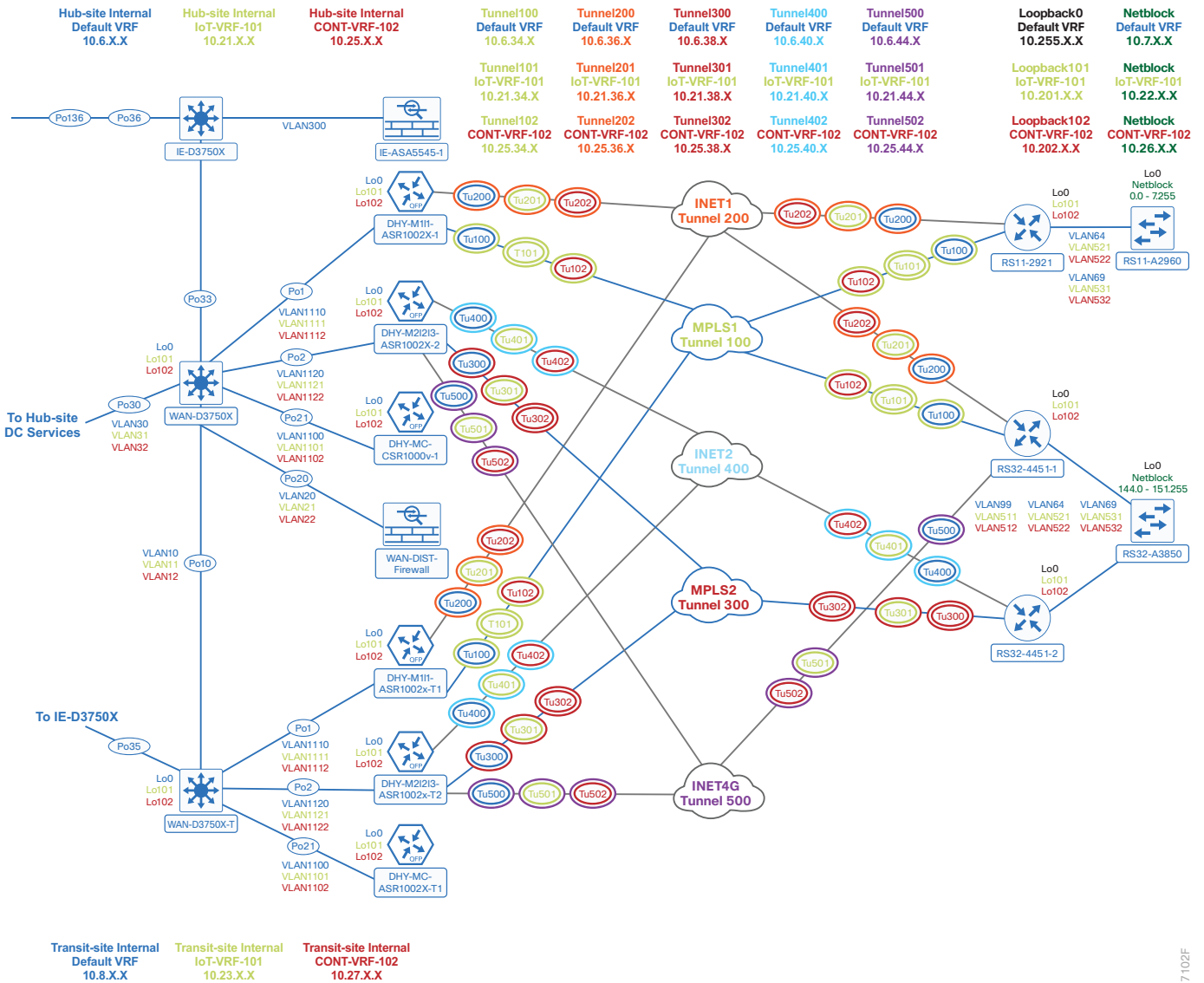

7102F

The following tables provide the loopback and port-channel IP addresses for the WAN aggregation devices in the IWAN dual hybrid with PLR and Multi-VRF design model.

**Table 14** IWAN dual hybrid with PLR and Multi-VRF model—Hub and transit router IP addresses (Default VRF)

IWAN function	Host name	Loopback IP address	Port channel IP address
Hub MC	DHY-MC-CSR1000V-1	10.6.32.251/32	10.6.32.151/26
Hub BR (MPLS1 & INET1)	DHY-M1I1-ASR1002X-1	10.6.32.241/32	10.6.32.2/30
Hub BR (MPLS2, INET2 and PLR)	DHY-M2I2I3-ASR1002X-2	10.6.32.242/32	10.6.32.6/30
Transit MC	DHY-MC-ASR1002X-T1	10.8.32.251/32	10.8.32.151/26
Transit BR (MPLS1 & INET1)	DHY-M1I1-ASR1002X-T1	10.8.32.241/32	10.8.32.2/30
Transit BR (MPLS2, INET2 and PLR)	DHY-M2I2I3-ASR1002X-T2	10.8.32.242/32	10.8.32.6/30

**Table 15** IWAN dual hybrid with PLR and Multi-VRF model—Hub and transit router IP addresses (IoT-VRF-101)

IWAN function	Host name	Loopback IP address	Port channel IP address
Hub MC	DHY-MC-CSR1000V-1	10.21.32.251/32	10.21.32.151/26
Hub BR (MPLS1 & INET1)	DHY-M1I1-ASR1002X-1	10.21.32.241/32	10.21.32.2/30
Hub BR (MPLS2, INET2 and PLR)	DHY-M2I2I3-ASR1002X-2	10.21.32.242/32	10.21.32.6/30
Transit MC	DHY-MC-ASR1002X-T1	10.23.32.251/32	10.23.32.151/26
Transit BR (MPLS1 & INET1)	DHY-M1I1-ASR1002X-T1	10.23.32.241/32	10.23.32.2/30
Transit BR (MPLS2, INET2 and PLR)	DHY-M2I2I3-ASR1002X-T2	10.23.32.242/32	10.23.32.6/30

**Table 16** IWAN dual hybrid with PLR and Multi-VRF model—Hub and transit router IP addresses (CONT-VRF-102)

IWAN function	Host name	Loopback IP address	Port channel IP address
Hub MC	DHY-MC-CSR1000V-1	10.25.32.251/32	10.25.32.151/26
Hub BR (MPLS1 & INET1)	DHY-M1I1-ASR1002X-1	10.25.32.241/32	10.25.32.2/30
Hub BR (MPLS2, INET2 and PLR)	DHY-M2I2I3-ASR1002X-2	10.25.32.242/32	10.25.32.6/30
Transit MC	DHY-MC-ASR1002X-T1	10.27.32.251/32	10.27.32.151/26
Transit BR (MPLS1 & INET1)	DHY-M1I1-ASR1002X-T1	10.27.32.241/32	10.27.32.2/30
Transit BR (MPLS2, INET2 and PLR)	DHY-M2I2I3-ASR1002X-T2	10.27.32.242/32	10.27.32.6/30



## CONFIGURATION FILES

Below are links to the configuration files for all dual hybrid with PLR and Multi-VRF hub and transit site WAN aggregation devices using BGP and OSPF:

- [The entire set](#)
- [DHY-MC-CSR1000V-1: Hub MC, BGP](#)
- [DHY-M1I1-ASR1002X-1: Hub BR, BGP \(MPLS1 & INET1\)](#)
- [DHY-M2I2I3-ASR1002X-2: Hub BR, BGP \(MPLS2, INET2 & PLR\)](#)
- [DHY-MC-ASR1002X-T1: Transit MC, BGP](#)
- [DHY-M1I1-ASR1002X-T1: Transit BR, BGP \(MPLS1 & INET1\)](#)
- [DHY-M2I2I3-ASR1002X-T2: Transit BR, BGP \(MPLS2, INET2 & PLR\)](#)
- [IW-WAN-D3750X: Hub WAN Agg Distribution Switch](#)
- [IW-WAN-D3750X-T: Transit WAN Agg Distribution Switch](#)
- [IW-IE-ASA5545X: Firewall](#)
- [DIST-WAN-FW: Hub-site inter-VRF route leaking firewall](#)

# IWAN Dual Hybrid with PLR and Multi-VRF Design Model for BGP-Remote Sites

Performance Routing Version 3 consists of two major Cisco IOS components: an MC and a BR. The MC defines the policies and applies them to various traffic classes that traverse the BR systems. The MC can be configured to learn and control traffic classes on the network.

There are two different roles a device can play at the remote site of a Pfrv3 configuration:

- **Branch master controller**—The branch MC is the MC at the branch-site. There is no policy configuration on this device. It receives policy from the hub MC. This device acts as MC for that site for making path-optimization decision. The configuration includes the IP address of the hub MC.
- **Branch border router**—This is a BR at the branch-site. The configuration on this device enables BR functionality and includes the IP address of the site local MC. The WAN interface that terminates on the device is detected automatically.

The following tables provide the loopback IP addresses for the remote site devices in the IWAN dual hybrid with PLR and Multi-VRF design model.

**Table 17** IWAN dual hybrid with PLR and Multi-VRF model—Remote site router IP addresses (Default VRF)

IWAN function	Host name	Loopback IP address
Branch MC/BR (MPLS1/INET1)	RS11-2921	10.255.241.11/32
Branch MC/BR (MPLS1/INET1/PLR)	RS32-4451-1	10.255.241.32/32
Branch BR (MPLS2/INET2)	RS32-4451-2	10.255.243.32/32

**Table 18** IWAN dual hybrid with PLR and Multi-VRF model—Remote site router IP addresses (IoT-VRF-101)

IWAN function	Host name	Loopback IP address
Branch MC/BR (MPLS1/INET1)	RS11-2921	10.201.241.11/32
Branch MC/BR (MPLS1/INET1/PLR)	RS32-4451-1	10.201.241.32/32
Branch BR (MPLS2/INET2)	RS32-4451-2	10.201.243.32/32

**Table 19** IWAN dual hybrid with PLR and Multi-VRF model—Remote site router IP addresses (CONT-VRF-102)

IWAN function	Host name	Loopback IP address
Branch MC/BR (MPLS1/INET1)	RS11-2921	10.202.241.11/32
Branch MC/BR (MPLS1/INET1/PLR)	RS32-4451-1	10.202.241.32/32
Branch BR (MPLS2/INET2)	RS32-4451-2	10.202.243.32/32

## CONFIGURATION FILES

Below are links to the configuration files for all dual hybrid with PLR and Multi-VRF remote site devices using BGP and OSPF:

- [The entire set](#)
- RS11–Single-Router, Two-Link, Access, BGP (MPLS1 and INET1):
  - [RS11-2921: MPLS1 and INET1 WAN links](#)
- RS32–Dual-Router, Five-Link, Access, BGP (MPLS1, MPLS2, INET1, INET2 and PLR):
  - [RS32-4451-1: MPLS1, INET1 and PLR WAN links](#)
  - [RS32-4451-2: MPLS2 and INET2 WAN links](#)



# Appendix A: Changes

This appendix summarizes the changes Cisco made to this guide since its last edition.

- Routing updates:
  - Changed an EIGRP summary address in the WAN aggregation switches to cover a larger range of networks at the hub location
  - Simplified the EIGRP tagging and removed the filtering that was no longer needed
  - Added the EIGRP data center affinity use case to hub and remote sites
- Hub BR updates:
  - Added the Multiple Tunnel Termination feature with EIGRP and BGP
- Public Key Infrastructure updates:
  - Changed the revocation-check to `crl none`
- Multi-VRF update:
  - Added Multi-VRF configuration with BGP





Please use the [feedback form](#) to send comments and suggestions about this guide.



**Americas Headquarters**  
Cisco Systems, Inc.  
San Jose, CA

**Asia Pacific Headquarters**  
Cisco Systems (USA) Pte. Ltd.  
Singapore

**Europe Headquarters**  
Cisco Systems International BV Amsterdam,  
The Netherlands

Cisco has more than 200 offices worldwide. Addresses, phone numbers, and fax numbers are listed on the Cisco Website at [www.cisco.com/go/offices](http://www.cisco.com/go/offices).

ALL DESIGNS, SPECIFICATIONS, STATEMENTS, INFORMATION, AND RECOMMENDATIONS (COLLECTIVELY, "DESIGNS") IN THIS MANUAL ARE PRESENTED "AS IS," WITH ALL FAULTS. CISCO AND ITS SUPPLIERS DISCLAIM ALL WARRANTIES, INCLUDING, WITHOUT LIMITATION, THE WARRANTY OF MERCHANTABILITY, FITNESS FOR A PARTICULAR PURPOSE AND NONINFRINGEMENT OR ARISING FROM A COURSE OF DEALING, USAGE, OR TRADE PRACTICE. IN NO EVENT SHALL CISCO OR ITS SUPPLIERS BE LIABLE FOR ANY INDIRECT, SPECIAL, CONSEQUENTIAL, OR INCIDENTAL DAMAGES, INCLUDING, WITHOUT LIMITATION, LOST PROFITS OR LOSS OR DAMAGE TO DATA ARISING OUT OF THE USE OR INABILITY TO USE THE DESIGNS, EVEN IF CISCO OR ITS SUPPLIERS HAVE BEEN ADVISED OF THE POSSIBILITY OF SUCH DAMAGES. THE DESIGNS ARE SUBJECT TO CHANGE WITHOUT NOTICE. USERS ARE SOLELY RESPONSIBLE FOR THEIR APPLICATION OF THE DESIGNS. THE DESIGNS DO NOT CONSTITUTE THE TECHNICAL OR OTHER PROFESSIONAL ADVICE OF CISCO, ITS SUPPLIERS OR PARTNERS. USERS SHOULD CONSULT THEIR OWN TECHNICAL ADVISORS BEFORE IMPLEMENTING THE DESIGNS. RESULTS MAY VARY DEPENDING ON FACTORS NOT TESTED BY CISCO.

Any Internet Protocol (IP) addresses used in this document are not intended to be actual addresses. Any examples, command display output, and figures included in the document are shown for illustrative purposes only. Any use of actual IP addresses in illustrative content is unintentional and coincidental.

© 2017 Cisco Systems, Inc. All rights reserved.

Cisco and the Cisco logo are trademarks or registered trademarks of Cisco and/or its affiliates in the U.S. and other countries. To view a list of Cisco trademarks, go to this URL: [www.cisco.com/go/trademarks](http://www.cisco.com/go/trademarks). Third-party trademarks mentioned are the property of their respective owners. The use of the word partner does not imply a partnership relationship between Cisco and any other company. (1110R)