



IronPort AsyncOS™ 6.5
USER GUIDE
for Web Security Appliances



COPYRIGHT

Copyright © 2010 by IronPort Systems® , Inc. All rights reserved.

Part Number: 421-0172

Revision Date: September 15, 2010

The IronPort logo, IronPort Systems, SenderBase, and AsyncOS are all trademarks or registered trademarks of IronPort Systems, Inc. All other trademarks, service marks, trade names, or company names referenced herein are used for identification only and are the property of their respective owners.

This publication and the information contained herein is furnished "AS IS" and is subject to change without notice. Publication of this document should not be construed as a commitment by IronPort Systems, Inc. IronPort Systems, Inc., assumes no responsibility or liability for any errors or inaccuracies, makes no warranty of any kind with respect to this publication, and expressly disclaims any and all warranties of merchantability, fitness for particular purposes and non-infringement of third-party rights.

Some software included within IronPort AsyncOS is distributed under the terms, notices, and conditions of software license agreements of FreeBSD, Inc., Stichting Mathematisch Centrum, Corporation for National Research Initiatives, Inc., and other third party contributors, and all such terms and conditions are incorporated in IronPort license agreements.

The full text of these agreements can be found at https://support.ironport.com/3rdparty/AsyncOS_User_Guide-1-1.html. Portions of the software within IronPort AsyncOS is based upon the RRDtool with the express written consent of Tobi Oetiker.

IRONPORT SYSTEMS® , INC. CONTACTING IRONPORT CUSTOMER SUPPORT

IronPort Systems, Inc.
950 Elm Ave.
San Bruno, CA 94066

If you have purchased support directly from IronPort Systems, you can request our support by phone, email or online 24 hours a day, 7 days a week. During our office hours (24 hours per day, Monday through Friday excluding US holidays), one of our engineers will contact you within an hour of your request. To report a critical issue that requires urgent assistance outside of our office hours, please call us immediately at the numbers below.

U.S. Toll-free: 1 (877) 641-4766

International:

<http://cisco.com/web/ironport/contacts.html>

Support Portal:

<http://www.cisco.com/cisco/web/support/index.html>

If you have purchased support through a reseller or another entity, please contact them for support of your IronPort products.

Table of Contents

1. Getting Started with the Web Security Appliance	1
What's New in This Release	2
New Feature: FIPS Compliance	2
What's New in Version 6.3	3
New Feature: Rich Acceptable Use Controls with URL Filtering	3
What's New in Version 6.0	4
New Feature: IronPort Data Security	4
New Feature: External Data Loss Prevention	4
New Feature: Native FTP	5
New Feature: Multiple Identities in a Policy Group	5
New Feature: Warning Users Before Continuing	5
Enhanced: Authentication	5
Enhanced: Logging	7
Enhanced: Accelerated AsyncOS Upgrades	8
How to Use This Guide	9
Before You Begin	9
Typographic Conventions	10
Where to Find More Information	10
IronPort Welcomes Your Comments	12
Web Security Appliance Overview	13
2. Using the Web Security Appliance	15
How the Web Security Appliance Works	16
Web Proxy	16
The L4 Traffic Monitor	16
Administering the Web Security Appliance	17
System Setup Wizard	17
Accessing the Web Security Appliance	17
Using the Command Line Interface (CLI)	18
The SenderBase Network	18
Reporting and Logging	18

- Navigating the Web Security Appliance Web Interface 19
 - Logging In 21
 - Browser Requirements 21
 - Monitor Tab 21
 - Web Security Manager Tab 22
 - Security Services Tab 22
 - Network Tab 23
 - System Administration Tab 23
- Committing and Clearing Changes 25
 - Committing and Clearing Changes in the Web Interface 25
 - Committing and Clearing Changes in the CLI 26

3. Deployment 27

- Deployment Overview 28
 - Preparing for Deployment 28
- Appliance Interfaces 30
 - Management Interface 30
 - Data Interfaces 30
 - L4 Traffic Monitor Interfaces 31
 - Example Deployment 31
- Deploying the Web Proxy in Explicit Forward Mode 33
 - Configuring Client Applications 33
 - Connecting Appliance Interfaces 33
 - Testing an Explicit Forward Configuration 33
- Deploying the Web Proxy in Transparent Mode 34
 - Connecting Appliance Interfaces 34
- Connecting the Appliance to a WCCP Router 35
 - Configuring the Web Security Appliance 35
 - Configuring the WCCP Router 35
 - Example WCCP Configurations 37
 - Working with Multiple Appliances and Routers 39
- Using the Web Security Appliance in an Existing Proxy Environment 40
 - Transparent Upstream Proxy 40
 - Explicit Forward Upstream Proxy 40
- Deploying the L4 Traffic Monitor 41
 - Connecting the L4 Traffic Monitor 41
 - Configuring an L4 Traffic Monitor Wiring Type 42
- Physical Dimensions 43

4. Installation and Configuration 45

- Before You Begin 46
 - Connecting a Laptop to the Appliance 46
 - Connecting the Appliance to the Network 46

Gathering Setup Information	47
System Setup Wizard	51
Accessing the System Setup Wizard	51
Step 1. Start	52
Step 2. Network	52
Step 3. Security	61
Step 4. Review	63

5. FIPS Management 67

FIPS Management Overview	68
Understanding How FIPS Management Works	69
Initializing the HSM Card	70
Logging into the FIPS Management Console	71
Working with the FIPS Officer Password	72
Supported Certificate Types	73
Logging	73
Managing Certificates and Keys	74
Uploading a Certificate and Key for Secure Authentication	75
Uploading and Generating a Certificate and Key for the HTTPS Proxy	76
Backing up and Restoring Certificates and Keys	79
Backing up Certificates and Keys	79
Restoring Certificates and Keys	80
Using the fipsconfig CLI Command	81
Working with Multiple HSM Cards	83

6. Web Proxy Services 85

About Web Proxy Services	86
Web Proxy Cache	86
Configuring the Web Proxy	88
Working with FTP Connections	92
Using Authentication with Native FTP	93
Working with Native FTP in Transparent Mode	94
Configuring FTP Proxy Settings	94
Bypassing the Web Proxy	98
How the Proxy Bypass List Works	99
Using WCCP with the Proxy Bypass List	99
Proxy Usage Agreement	100
Configuring Client Applications to Use the Web Proxy	101
Working with PAC Files	102
PAC File Format	102
Creating a PAC File for Remote Users	103
Specifying the PAC File in Browsers	103

Adding PAC Files to the Web Security Appliance	106
Uploading PAC Files to the Appliance	106
WPAD Compatibility with Netscape and Firefox	107
Advanced Proxy Configuration	108
Authentication Options	109
Caching Options	114
DNS Options	117
NATIVEFTP Options	118
FTPOVERHTTP Options	120
HTTPS Options	120
WCCP Options	121
Miscellaneous Options	121

7. Working with Policies 125

Working with Policies Overview	126
Policy Types	127
Identities	127
Decryption Policies	127
Routing Policies	128
Access Policies	128
IronPort Data Security Policies	128
External DLP Policies	128
Working with Policy Groups	130
Creating Policy Groups	130
Using the Policies Tables	130
Policy Group Membership	133
Authenticating Users versus Authorizing Users	133
Working with All Identities	134
Policy Group Membership Rules and Guidelines	135
Working with Time Based Policies	136
Creating Time Ranges	136
Working with User Agent Based Policies	138
Configuring User Agents for Policy Group Membership	138
Exempting User Agents from Authentication	140
Tracing Policies	141

8. Identities 145

Identities Overview	146
Evaluating Identity Group Membership	147
How Authentication Affects Identity Groups	148
How Authentication Affects HTTPS and FTP over HTTP Requests	149
How Authentication Scheme Affects Identity Groups	151
Matching Client Requests to Identity Groups	152

Allowing Guest Access to Users Who Fail Authentication	155
Creating Identities	158
Configuring Identities in Other Policy Groups	162
Example Identity Policies Tables.	165
Example 1	165
Example 2	166
9. Access Policies	169
Access Policies Overview	170
Access Policy Groups	170
Understanding the Monitor Action	171
Evaluating Access Policy Group Membership	172
Matching Client Requests to Access Policy Groups	172
Creating Access Policies	174
Controlling HTTP and Native FTP Traffic	177
Applications	179
URL Categories	179
Object Blocking	180
Web Reputation and Anti-Malware	181
Blocking Specific Applications and Protocols	182
Blocking on Port 80	182
Blocking on Ports Other Than 80	184
10. Working with External Proxies	187
Working with External Proxies Overview	188
Routing Traffic to Upstream Proxies	189
Adding External Proxy Information	191
Evaluating Routing Policy Group Membership	193
Matching Client Requests to Routing Policy Groups	193
Creating Routing Policies	195
11. Decryption Policies	199
Decryption Policies Overview	200
Decryption Policy Groups	201
Personally Identifiable Information Disclosure	202
Understanding the Monitor Action	202
Digital Cryptography Terms	204
HTTPS Basics	206
SSL Handshake	206
Digital Certificates	208
Validating Certificate Authorities	208

- Validating Digital Certificates 210
- Decrypting HTTPS Traffic 211
 - Working with Root Certificates 213
 - Converting Certificate and Key Formats 215
- Enabling the HTTPS Proxy 217
- Evaluating Decryption Policy Group Membership 221
 - Matching Client Requests to Decryption Policy Groups 221
- Creating Decryption Policies 223
- Controlling HTTPS Traffic 227
- Importing a Trusted Root Certificate 231

12. Data Security and External DLP Policies 233

- Data Security and External DLP Policies Overview 234
 - Bypassing Upload Requests Below a Minimum Size 234
 - User Experience with Blocked Requests 235
- Working with Data Security and External DLP Policies 236
 - Data Security Policy Groups 236
 - External DLP Policy Groups 237
- Evaluating Data Security and External DLP Policy Group Membership 239
 - Matching Client Requests to Data Security and External DLP Policy Groups 239
- Creating Data Security and External DLP Policies 241
- Controlling Upload Requests Using IronPort Data Security Policies 245
 - URL Categories 246
 - Web Reputation 247
 - Content Blocking 247
- Defining External DLP Systems 249
- Controlling Upload Requests Using External DLP Policies 252
- Logging 254

13. Notifying End Users 257

- Notifying End Users of Organization Policies 258
- Configuring General Settings for Notification Pages 260
- Working With IronPort End-User Notification Pages 262
 - Configuring IronPort Notification Pages 262
 - Editing IronPort Notification Pages 264
- Working with User Defined End-User Notification Pages 269
 - Configuring User Defined End-User Notification Pages 271
- End-User Acknowledgement Page 272
 - Configuring the End-User Acknowledgement Page 273
- Configuring the End-User URL Category Warning Page 276
- Working with IronPort FTP Notification Messages 277

Custom Text in Notification Pages	278
Supported HTML Tags in Notification Pages	278
Custom Text and Logos: Authentication, and End-User Acknowledgement Pages	278
Notification Page Types	280

14. URL Filters 287

URL Filters Overview	288
Dynamic Content Analysis Engine	288
Uncategorized URLs	289
Matching URLs to URL Categories	290
The URL Categories Database	290
Configuring the URL Filtering Engine	291
Filtering Transactions Using URL Categories	292
Configuring URL Filters for Access Policy Groups	292
Configuring URL Filters for Decryption Policy Groups	295
Configuring URL Filters for Data Security Policy Groups	297
Custom URL Categories	301
Redirecting Traffic	304
Warning Users and Allowing Them to Continue	306
User Experience When Warning Users	307
Creating Time Based URL Filters	308
Viewing URL Filtering Activity	309
Understanding Unfiltered and Uncategorized Data	309
Access Log File	309
Regular Expressions	310
Forming Regular Expressions	310
Regular Expression Character Table	311
URL Category Descriptions	313

15. Web Reputation Filters 329

Web Reputation Filters Overview	330
The Web Reputation Database	330
Web Reputation Scores	331
Enabling Web Reputation Filters	332
How Web Reputation Filtering Works	333
Web Reputation in Access Policies	333
Web Reputation in Decryption Policies	334
Configuring Web Reputation Scores	335
Configuring Web Reputation for Access Policies	335
Configuring Web Reputation for Decryption Policies	336
Configuring Web Reputation for IronPort Data Security Policies	337
Viewing Web Reputation Filtering Activity	338

Reports	338
Monitoring Filter and Scoring Activity	338
Access Log File	338

16. Anti-Malware Services 339

Anti-Malware Overview	340
Malware Category Descriptions	340
IronPort DVS™ (Dynamic Vectoring and Streaming) Engine	342
Maintaining the Database Tables	342
How the DVS Engine Works	342
Working with Multiple Malware Verdicts	343
Webroot Scanning	345
McAfee Scanning	346
Matching Virus Signature Patterns	346
Heuristic Analysis	346
McAfee Categories	347
Configuring Anti-Malware Scanning	348
Viewing Anti-Malware Scanning Activity	352
Reports	352
Monitoring Scanning Activity	352
Access Log File	352

17. Authentication 353

Authentication Overview	354
Client Application Support	354
Working with Upstream Proxy Servers	355
Authenticating Users	355
Working with Failed Authentication	356
How Authentication Works	357
Basic versus NTLMSSP Authentication Schemes	358
How Web Proxy Deployment Affects Authentication	359
Working with Authentication Realms	364
Creating Authentication Realms	364
Editing Authentication Realms	365
Deleting Authentication Realms	365
Working with Authentication Sequences	366
Creating Authentication Sequences	367
Editing Authentication Sequences	367
Deleting Authentication Sequences	368
Appliance Behavior with Multiple Authentication Realms	369
Testing Authentication Settings	370
Testing Process	370
Testing Authentication Settings in the Web Interface	371

Testing Authentication Settings in the CLI	372
Configuring Global Authentication Settings	373
Sending Authentication Credentials Securely	383
Allowing Users to Re-Authenticate	386
Using Re-Authentication with Internet Explorer	387
Using Re-Authentication with PAC Files	387
Tracking Authenticated Users	389
LDAP Authentication	390
Changing Active Directory Passwords	390
LDAP Authentication Settings	390
NTLM Authentication	396
Working with Multiple Active Directory Domains	396
NTLM Authentication Settings	397
Joining the Active Directory Domain	398
Supported Authentication Characters	401
Active Directory Server Supported Characters	401
LDAP Server Supported Characters	403
18. L4 Traffic Monitor	405
About L4 Traffic Monitor	406
How the L4 Traffic Monitor Works	407
The L4 Traffic Monitor Database	408
Configuring the L4 Traffic Monitor	409
Configuring L4 Traffic Monitor Global Settings	409
Configuring L4 Traffic Monitor Policies	410
Viewing L4 Traffic Monitor Activity	413
Reports	413
Monitoring Activity and Viewing Summary Statistics	413
L4 Traffic Monitor Log File Entries	413
19. Monitoring	415
Monitoring System Activity	416
Using the Monitor Tab	417
Changing the Timeframe	417
Searching Data	417
Overview Page	419
L4 Traffic Monitor Data Page	420
Clients Pages	421
Web Site Activity Page	422
Anti-Malware Page	423
URL Categories Page	424
Web Reputation Filters Page	425

- System Status Page 426
- SNMP Monitoring 427
 - MIB Files 427
 - Hardware Objects 428
 - SNMP Traps 429

- 20. Reporting 433**
 - Reporting Overview 434
 - Scheduling Reports 435
 - Adding a Scheduled Report 435
 - Editing Scheduled Reports 436
 - Deleting Scheduled Reports 436
 - On-Demand Reports 437
 - Archiving Reports 438
 - Exporting Report Data 439

- 21. Logging 441**
 - Logging Overview 442
 - Log File Types 442
 - Web Proxy Logging 446
 - Working with Log Subscriptions 448
 - Log File Name and Appliance Directory Structure 449
 - Rolling Over Log Subscriptions 449
 - Working with Compressed Log Files 450
 - Viewing the Most Recent Log Files 450
 - Configuring Host Keys 450
 - Adding and Editing Log Subscriptions 451
 - Deleting a Log Subscription 455
 - Access Log File 456
 - Transaction Result Codes 458
 - ACL Decision Tags 459
 - Understanding Web Reputation and Anti-Malware Information 462
 - W3C Compliant Access Logs 467
 - W3C Log File Headers 467
 - Working with Log Fields in W3C Access Logs 468
 - Custom Formatting in Access Logs and W3C Logs 470
 - Configuring Custom Formatting in Access Logs 477
 - Configuring Custom Formatting in W3C Logs 477
 - Including HTTP/HTTPS Headers in Log Files 479
 - Malware Scanning Verdict Values 480
 - Traffic Monitor Log 482

22. Configuring Network Settings 483

Changing the System Hostname	484
Configuring Network Interfaces	485
Configuring the Data Interfaces	485
Configuring the Network Interfaces from the Web Interface	486
Configuring TCP/IP Traffic Routes	489
Modifying the Default Route	489
Working With Routing Tables	490
Virtual Local Area Networks (VLANs)	491
VLANs and Physical Ports	492
Managing VLANs	492
Configuring Transparent Redirection	495
Working with WCCP Services	495
Working with the Assignment Method	496
Working with the Forwarding and Return Method	497
IP Spoofing when Using WCCP	497
Adding and Editing a WCCP Service	498
Deleting a WCCP Service	501
Configuring SMTP Relay Hosts	502
Configuring SMTP from the Web Interface	502
Configuring SMTP from the CLI	503
Configuring DNS Server(s)	504
Specifying DNS Servers	504
Split DNS	504
Using the Internet Root Servers	504
Multiple Entries and Priority	504
DNS Alert	505
Clearing the DNS Cache	505
Configuring DNS	505

23. System Administration 507

Managing the S-Series Appliance	508
Managing the Appliance Configuration	508
Support Commands	509
Open a Support Case	509
Remote Access	510
Packet Capture	511
Working with Feature Keys	515
Feature Keys Page	515
Feature Key Settings Page	516
Expired Feature Keys	516
Administering User Accounts	517
Managing Local Users	517
Using External Authentication	520

- Configuring Administrator Settings 523
 - Configuring Custom Text at Login 523
 - Configuring IP-Based Administrator Access 523
 - Configuring the SSL Ciphers for Administrator Access 523
- Configuring the Return Address for Generated Messages 524
- Managing Alerts 525
 - Alerting Overview 525
 - IronPort AutoSupport 527
 - Alert Messages 527
 - Managing Alert Recipients 528
 - Configuring Alert Settings 531
- Setting System Time 532
 - Selecting a Time Zone 532
 - Editing System Time 532
- Installing a Server Digital Certificate 534
 - Obtaining Certificates 534
 - Uploading Certificates to the Web Security Appliance 535
- Upgrading the System Software 537
 - Upgrading AsyncOS for Web from the Web Interface 537
 - Upgrading AsyncOS for Web from the CLI 538
- Configuring Upgrade and Service Update Settings 539
 - Updating and Upgrading from the IronPort Update Servers 540
 - Upgrading from a Local Server 540
 - Configuring the Update and Upgrade Settings from the Web Interface 542
 - Configuring the Update and Upgrade Settings from the CLI 545
 - Manually Updating Security Service Components 545

24. Command Line Interface 547

- The Command Line Interface Overview 548
- Using the Command Line Interface 549
 - Accessing the Command Line Interface 549
 - Working with the Command Prompt 549
 - Command Syntax 550
 - Select Lists 550
 - Yes/No Queries 550
 - Subcommands 550
 - Command History 551
 - Completing Commands 551
 - Configuration Changes 551
- General Purpose CLI Commands 552
 - Committing Configuration Changes 552
 - Clearing Configuration Changes 552
 - Exiting the Command Line Interface Session 552
 - Seeking Help on the Command Line Interface 553

Web Security Appliance CLI Commands	554
A. IronPort End User License Agreement	559
Cisco IronPort Systems, LLC Software License Agreement	560
Index	565

List of Figures

Figure 2-1	Web Interface Tabs, Pages, and Categories	20
Figure 2-2	The Commit Button: Changes Pending	25
Figure 2-3	The Commit Button: No Changes Pending	25
Figure 3-1	Web Security Appliance Ethernet Ports	30
Figure 3-2	Web Security Appliance Deployment Scenario.	32
Figure 3-3	Example WCCP Service — Standard Service, No Password Required	37
Figure 3-4	Example WCCP Service — Dynamic Service for IP Spoofing	38
Figure 3-5	Example WCCP Service — Dynamic Service, Password Required	39
Figure 3-6	L4 Traffic Monitor Wiring Types	42
Figure 4-1	System Setup Wizard — Start Tab	52
Figure 4-2	System Setup Wizard — Network Tab, System Settings	53
Figure 4-3	System Setup Wizard — Network Tab, Network Context Page	54
Figure 4-4	System Setup Wizard — Network Tab, Network Interfaces and Wiring Page	56
Figure 4-5	System Setup Wizard — Network Tab, Routes for Traffic Page	58
Figure 4-6	System Setup Wizard — Network Tab, Transparent Connection Settings Page	59
Figure 4-7	System Setup Wizard — Network Tab, Administrative Settings Page	60
Figure 4-8	System Setup Wizard — Security Tab	62
Figure 4-9	System Setup Wizard — Review Tab	64
Figure 5-1	FIPS Mode Menu	71
Figure 5-2	FIPS Login Page	72
Figure 5-3	FIPS Management Console	72
Figure 5-4	Edit Password Management Settings Page	73

Figure 5-5	Edit Key Management Settings Page	74
Figure 5-6	Secure Authentication Certificate and Key Section	75
Figure 5-7	HTTPS Proxy Certificate and Key Section	76
Figure 5-8	Backing up and Restoring Certificates and Keys	79
Figure 6-1	Editing Web Proxy Settings	88
Figure 6-2	Configuring FTP Proxy Settings	95
Figure 6-3	Proxy Bypass List	98
Figure 6-4	Editing the PAC File Host Settings	106
Figure 7-1	Access Policies Table	131
Figure 7-2	Decryption Policies Table	131
Figure 7-3	Defining Policy Group Membership by User Agent	139
Figure 7-4	Policy Trace Feature Advanced Section	142
Figure 7-5	Policy Trace Results	144
Figure 8-1	Identity Groups that Require Authentication	148
Figure 8-2	Policy Group Flow Diagram for Identities - No Surrogates and IP-Based Surrogates	153
Figure 8-3	Policy Group Flow Diagram for Identities - Cookie-Based Surrogates	154
Figure 8-4	Multiple Identities in a Policy Group	162
Figure 9-1	Policy Group Flow Diagram for Access Policies	173
Figure 9-2	Creating Secure Access Policies	177
Figure 9-3	Applying Access Policy Actions	178
Figure 9-4	Custom Settings for Controlling Applications	179
Figure 9-5	Blocking Object Types	180
Figure 9-6	Entering Agent Patterns to Block	183
Figure 10-1	Routing Policies	189
Figure 10-2	Policy Group Flow Diagram for Routing Policies	194
Figure 11-1	HTTPS and HTTP OSI Layers	206
Figure 11-2	Certification Path Example	209
Figure 11-3	HTTPS Connection	211
Figure 11-4	HTTPS Connection Decrypted by the Web Security Appliance	211
Figure 11-5	Unknown Certificate Authority Error Message	214
Figure 11-6	Certificate Issued by Web Security Appliance	215
Figure 11-7	Policy Group Flow Diagram for Decryption Policies	222

Figure 11-8	HTTPS Policies Table	227
Figure 11-9	Applying Decryption Policy Actions	229
Figure 12-1	Policy Group Flow Diagram for Data Security and External DLP Policies	240
Figure 12-2	Creating Secure IronPort Data Security Policies	245
Figure 12-3	Applying Data Security Policy Actions	246
Figure 12-4	IronPort Data Security Policies Content Settings	248
Figure 12-5	Network > External DLP Servers Page.	249
Figure 12-6	Configuring External DLP Servers	249
Figure 12-7	Creating External DLP Policies	252
Figure 12-8	Scanning Destinations Settings for External DLP Policies	253
Figure 13-1	Security Services > End-User Notification Page.	258
Figure 13-2	Editing End-User Acknowledgment Page Settings	274
Figure 13-3	Editing End-User URL Category Warning Page Settings.	276
Figure 14-1	Configuring Access Policy URL Categories	293
Figure 14-2	Configuring Decryption Policy URL Categories.	296
Figure 14-3	Configuring Data Security Policy URL Categories	298
Figure 14-4	Custom URL Categories Page	301
Figure 14-5	Creating a Custom URL Category	302
Figure 14-6	Defining Time Based URL Filtering Actions	308
Figure 15-1	Web Reputation Filter Settings for Access Policies	335
Figure 15-2	Web Reputation Filter Settings for Decryption Policies	336
Figure 15-3	Web Reputation Filter Settings for IronPort Data Security Policies.	337
Figure 16-1	Access Policy Anti-Malware Settings.	350
Figure 17-1	Web Security Appliance Authentication	357
Figure 17-2	Authentication Page — Authentication Realms	364
Figure 17-3	Authentication Page — Authentication Sequences	366
Figure 17-4	Network > Authentication Page — Test Current Settings Section	371
Figure 17-5	Authentication Testing Results	371
Figure 17-6	Network > Authentication Page	373
Figure 17-7	Global Authentication Settings	374
Figure 17-8	Transparent Proxy Mode Authentication Settings	375
Figure 17-9	Explicit Forward Proxy Mode Authentication Settings	379

Figure 17-10	Joining an Active Directory Domain	399
Figure 18-1	Security Services > L4 Traffic Monitor Page	409
Figure 19-1	Selecting Data Time Range	417
Figure 19-2	Searching for Web Sites or Clients	418
Figure 20-1	Scheduling Reports	435
Figure 20-2	Generating an On-Demand Report	437
Figure 21-1	Log File Subscriptions	448
Figure 21-2	Configuring Custom Log Fields in the Access Logs	477
Figure 21-3	Configuring Custom Log Fields in the W3C Logs	478
Figure 22-1	Editing Network Interfaces	487
Figure 22-2	Editing the Default Route	489
Figure 22-3	Adding a Route	490
Figure 22-4	Using VLANs to Increase the Number of Networks Available on the Appliance.	491
Figure 22-5	Network > Transparent Redirection Page.	495
Figure 22-6	Edit DNS Settings.	506
Figure 23-1	Open a Technical Support Case Page	510
Figure 23-2	Remote Access Page	511
Figure 23-3	Editing Packet Capture Settings in the Web Interface	514
Figure 23-4	The Feature Keys Page	515
Figure 23-5	The Feature Key Settings Page	516
Figure 23-6	System Administration > Users Page	517
Figure 23-7	Adding a Local User	518
Figure 23-8	The Change Password Option	519
Figure 23-9	Enabling External Authentication	520
Figure 23-10	Enabling External Authentication Using RADIUS	521
Figure 23-11	Configuring Return Addresses	524
Figure 23-12	Editing Return Address Settings	524
Figure 23-13	The Alerts Page	529
Figure 23-14	Adding a New Alert Recipient	530
Figure 23-15	Editing Alert Settings	531
Figure 23-16	The Time Zone Page	532
Figure 23-17	The Edit Time Settings Page	533

Figure 23-18 IronPort Appliance Demo Certificate as an Unknown Authority	534
Figure 23-19 The Available Upgrades Page	537
Figure 23-20 System Administration > Upgrade and Update Settings Page	540
Figure 23-21 Upgrading from a Local Server	541
Figure 23-22 Edit Update Settings Page	543

List of Tables

Table 3-1:	WCCP Router Configuration Syntax for Enabling the Router	36
Table 4-1:	System Setup Worksheet.	47
Table 4-2:	System Setting Options in System Setup Wizard	53
Table 4-3:	Network Context Options in System Setup Wizard	55
Table 4-4:	Network Interfaces and Wiring Options in System Setup Wizard	56
Table 4-5:	Routes for Management and Data Traffic Options in System Setup Wizard.	58
Table 4-6:	Transparent Connection Options in System Setup Wizard	60
Table 4-7:	Administrative Settings in System Setup Wizard	61
Table 4-8:	Security Options in System Setup Wizard	62
Table 5-1:	fipsconfig Subcommands	81
Table 6-1:	Web Proxy Settings.	89
Table 6-2:	FTP Proxy Settings	95
Table 6-3:	advancedproxyconfig CLI Command—Authentication Options	109
Table 6-4:	advancedproxyconfig CLI Command—Caching Options	114
Table 6-5:	advancedproxyconfig CLI Command—DNS Options	117
Table 6-6:	advancedproxyconfig CLI Command—NATIVEFTP Options.	118
Table 6-7:	advancedproxyconfig CLI Command—FTPOVERHTTP Options.	120
Table 6-8:	advancedproxyconfig CLI Command—HTTPS Options	120
Table 6-9:	advancedproxyconfig CLI Command—WCCP Options.	121
Table 6-10:	advancedproxyconfig CLI Command—Miscellaneous Options.	121
Table 7-1:	Policy Trace Advanced Settings for Requests	143

Table 7-2:	Policy Trace Advanced Settings for Response Overrides	143
Table 8-1:	Matching HTTPS and FTP over HTTP Requests to Identities	150
Table 8-2:	Identity Group Advanced Options	160
Table 8-3:	Policies Table Example 1	165
Table 8-4:	Policies Table Example 2	166
Table 9-1:	Access Policy Group Advanced Options	175
Table 9-2:	Common Application Agent Patterns	183
Table 10-1:	Policy Group Advanced Options	196
Table 11-1:	Cryptography Terms and Definitions	204
Table 11-2:	Decryption Policy Group Advanced Options	224
Table 12-1:	Data Security and External DLP Policy Group Advanced Options	242
Table 12-2:	External DLP Server Settings	250
Table 12-3:	Data Security Log Fields	254
Table 13-1:	IronPort Notification Page Settings	263
Table 13-2:	Variables for Customized End-User Notification Pages	264
Table 13-3:	Creating Conditional Variables in IronPort Notification Pages	267
Table 13-4:	End-User Notification Parameters for Redirected URLs	269
Table 13-5:	Codes Used in Notification Pages	280
Table 13-6:	Notification Page Types	281
Table 14-1:	URL Category Filtering for Access Policies	294
Table 14-2:	URL Category Filtering for Decryption Policies	296
Table 14-3:	URL Category Filtering for IronPort Data Security Policies	299
Table 14-4:	Custom URL Category Settings	302
Table 14-5:	Regular Expression Character Descriptions	311
Table 14-6:	URL Category Descriptions for Cisco IronPort Web Usage Controls	313
Table 14-7:	URL Categories for IronPort URL Filters	326
Table 15-1:	Default Web Reputation Scores for Access Policies	333
Table 15-2:	Default Web Reputation Scores for Decryption Policies	334
Table 15-3:	Web Reputation Filtering Reports	338
Table 16-1:	Malware Category Descriptions	340

Table 16-2: Appliance Categories for McAfee Verdicts	347
Table 16-3: Anti-Malware Settings.	348
Table 16-4: Anti-Malware Settings for Access Policies.	350
Table 16-5: Anti-Malware Scanning Reports	352
Table 17-1: Web Security Appliance Authentication Scenarios	358
Table 17-2: Basic versus NTLMSSP Authentication Schemes	359
Table 17-3: Methods of Authentication	359
Table 17-4: Pros and Cons of Explicit Forward Basic Authentication	360
Table 17-5: Pros and Cons of Transparent Basic Authentication—IP Caching	361
Table 17-6: Pros and Cons of Transparent Basic Authentication—Cookie Caching	362
Table 17-7: Pros and Cons of Explicit Forward NTLM Authentication	363
Table 17-8: Global Authentication Settings	374
Table 17-9: Transparent Proxy Mode Authentication Settings	376
Table 17-10: Explicit Forward Proxy Mode Authentication Settings	380
Table 17-11: Supported Authentication Surrogates	389
Table 17-12: LDAP Authentication Settings	390
Table 17-13: LDAP Group Authorization—Group Object Settings.	394
Table 17-14: LDAP Group Authorization—User Object Settings.	394
Table 17-15: NTLM Authentication Settings	397
Table 17-16: Supported Active Directory Server Characters — User Name Field.	401
Table 17-17: Supported Active Directory Server Characters — Password Field	401
Table 17-18: Supported Active Directory Server Characters — Location Field.	402
Table 17-19: Supported Active Directory Server Characters — Group Field	402
Table 17-20: Supported LDAP Server Characters — User Name Field.	403
Table 17-21: Supported LDAP Server Characters — Password Field	403
Table 17-22: Supported LDAP Server Characters — Group Field.	403
Table 17-23: Supported LDAP Server Characters — Custom User Filter Query Field	404
Table 17-24: Supported LDAP Server Characters — Custom Group Filter Query Field	404
Table 18-1: L4 Traffic Monitor Policies	411
Table 18-2: L4 Traffic Monitor Scanning Data	413

Table 19-1: Time Intervals for Data Collection 417

Table 19-2: System Status 426

Table 19-3: Number of Hardware Objects per IronPort Appliance 428

Table 19-4: Hardware Traps: Temperature and Hardware Conditions. 428

Table 20-1: Viewing Raw Data Entries 439

Table 21-1: Default Log File Types 442

Table 21-2: Managing Host Keys—List of Subcommands 451

Table 21-3: Logging Levels 453

Table 21-4: Log Transfer Protocols 453

Table 21-5: Access Log File Entry 456

Table 21-6: Transaction Result Codes 458

Table 21-7: ACL Decision Tag Values. 459

Table 21-8: Access Log File Entry — Web Reputation and Anti-Malware Information. 462

Table 21-9: W3C Log File Header Fields 468

Table 21-10: W3C Log Field Prefixes 469

Table 21-11: Log Fields in W3C Logs and Format Specifiers in Access Logs 470

Table 21-12: Configuring HTTP/HTTPS Headers in Log Files 479

Table 21-13: Malware Scanning Verdict Values 480

Table 22-1: Web Security Appliance Network Interface Settings. 485

Table 22-2: Interface Settings 487

Table 22-3: WCCP Service Options 499

Table 22-4: SMTP Relay Host Settings 503

Table 22-5: Example of DNS Servers, Priorities, and Timeout Intervals 505

Table 23-1: Packet Capture Configuration Options. 513

Table 23-2: User Groups 518

Table 23-3: Alert Classifications and Components 525

Table 23-4: Update and Upgrade Settings. 544

Table 24-1: Web Security appliance Administrative Commands 554

Getting Started with the Web Security Appliance

The *IronPort AsyncOS for Web User Guide* provides instructions for setting up, administering, and monitoring the IronPort Web Security appliance. These instructions are designed for an experienced system administrator with knowledge of networking and web administration.

This chapter discusses the following topics:

- “What’s New in This Release” on page 2
- “What’s New in Version 6.3” on page 3
- “What’s New in Version 6.0” on page 4
- “How to Use This Guide” on page 9
- “Web Security Appliance Overview” on page 13

WHAT'S NEW IN THIS RELEASE

This section describes the new features and enhancements in AsyncOS for Web 6.5. For more information about the release, see the product release notes, which are available on the IronPort Customer Support Portal at the following URL:

<http://www.cisco.com/cisco/web/support/index.html>

You might also find it useful to review release notes for earlier releases to see the features and enhancements that were previously added.

New Feature: FIPS Compliance

AsyncOS for Web 6.5 provides support for the new FIPS-compliant version of the Cisco IronPort S670 Web Security appliance.

The Federal Information Processing Standard (FIPS) 140 is a publicly announced standard developed jointly by the United States and Canadian federal governments specifying requirements for cryptographic modules that are used by all government agencies to protect sensitive but unclassified information. The Cisco IronPort S670 Web Security appliance is offered with a Hardware Security Module (HSM) card that is FIPS 140-2 level 2 certified. This standard specifies additional protections for information used in cryptographic operations, including the use of a tamper-resistant hardware keystore for private keys.

When the Cisco IronPort S670 Web Security appliance includes the HSM card and uses AsyncOS for Web 6.5, it offloads cryptographic operations to the HSM card in a FIPS compliant manner. The HSM card is responsible for the storage and protection of the cryptographic keys.

AsyncOS for Web 6.5 provides support for using the HSM for all cryptographic operations performed by the appliance. It also provides a FIPS management console to allow an administrator to configure the HSM for use in a clustered environment and manage certificates and private keys.

For more information, see Chapter 5, "FIPS Management," on page 67.

WHAT'S NEW IN VERSION 6.3

This section describes new features and enhancements added in the AsyncOS 6.3 for Web release.

New Feature: Rich Acceptable Use Controls with URL Filtering

AsyncOS for Web 6.3 introduces a new platform, Cisco IronPort Web Usage Controls, for rich acceptable use controls to address the challenge of current day Web traffic. The new platform includes a new and improved URL filtering engine with dynamic categorization capabilities for the uncategorized traffic. Subsequent releases will build on this new platform to include additional capabilities for application control and bandwidth management.

Cisco IronPort Web Usage Controls includes the Dynamic Content Analysis engine, a highly sophisticated technology on the appliance for real-time analysis of uncategorized sites. This engine improves URL filtering by categorizing some of the uncategorized traffic in real-time, and is especially effective for commonly blocked categories containing objectionable content. This addresses the challenge posed by thousands of sites being added to the Web every few minutes. URL databases have difficulty keeping up with this volume and they take time to update.

The new URL filtering engine has more granular categories. Efficacy for the new URL filtering engine is supported by a combination of sophisticated backend tools, processes, and a global team of categorization experts to provide continuous automatic updates to the URL database on customers' Web Security appliances. This also results in a huge improvement in our responsiveness for categorization or re-categorization requests.

For more information, see the "URL Filters Overview" on page 288.

WHAT'S NEW IN VERSION 6.0

This section describes new features and enhancements added in the AsyncOS 6.0 for Web release.

New Feature: IronPort Data Security

AsyncOS for Web 6.0 includes the IronPort Data Security Filters to provide you visibility and control over data leaving your network via the web and FTP. This feature allows you to create policies and take actions based on relevant parameters like the source (user), destination (URL categories and web reputation), and file metadata (file name, file type, and file size). For example, you can enforce the following business policies using IronPort Data Security:

- Do not allow members in the Finance department to send Excel files.
- Do not allow attachments in outgoing web-based emails to exceed 100 KB.

Additionally, IronPort Data Security logs all the upload transactions so that you can retain the record for HR investigations if a data loss incident is reported.

To use IronPort Data Security, first you enable the IronPort Data Security Filters, and then you create IronPort Data Security Policies to create the business policies you want to enforce.

For more information, see Chapter 12, “Data Security and External DLP Policies,” on page 233.

New Feature: External Data Loss Prevention

AsyncOS for Web 6.0 interoperates with leading Data Loss Prevention (DLP) vendors for advanced web DLP. The Web Security appliance sends the outbound traffic to the configured third party external DLP server, and enforces the verdict returned by the DLP server. This allows you to use content scanning, dictionaries, file fingerprinting and other techniques to satisfy advanced web DLP use cases like regulatory compliance and case management.

To use data loss prevention, first you define external DLP servers on the Web Security appliance, and then you create External DLP Policies.

Even when the appliance uses External DLP Policies, IronPort recommends that you also use IronPort Data Security in parallel because this combination has better performance than using External DLP Policies alone. IronPort Data Security Policies can block uploaded content sooner than External DLP Policies in many cases. For example, you might use the IronPort Data Security Policies to block data uploads to websites with a low reputation score. This way, the data is never sent to the External DLP system for a deep content scan, which improves overall performance. Content that needs deeper inspection can be selectively passed to the External DLP server for content analysis.

For more information, see Chapter 12, “Data Security and External DLP Policies,” on page 233.

New Feature: Native FTP

Prior to AsyncOS for Web 6.0, the Web Security appliance supported FTP over HTTP in addition to HTTP and HTTPS.

With AsyncOS for Web 6.0, the Web Security appliance supports traffic sent over native FTP. This allows you to control and secure the native FTP traffic in your organization, in addition to HTTP and HTTPS traffic. For example, you can control users who are allowed to download or upload documents over FTP. You can also scan content downloaded over FTP with the IronPort DVS engine and the anti-malware scanning engines.

For more information, see “Working with FTP Connections” on page 92.

New Feature: Multiple Identities in a Policy Group

In AsyncOS for Web 6.0, you can add multiple Identities to a single non-Identity policy group. This allows you to keep Identities as granular as required, and then either associate them all with a single policy group or with different policy groups. This can be useful after a merger, when you need to keep the Identities of the merged companies separate because they use different authentication realms, but use both these Identities together in a single uniform policy.

For more information, see “Configuring Identities in Other Policy Groups” on page 162.

New Feature: Warning Users Before Continuing

With AsyncOS for Web 6.0, you can warn users that a site does not meet the organization's acceptable use policies and allow them to continue if they choose. To warn users and allow them to continue, configure the URL categories for an Access Policy group.

When users access a URL that is configured to warn and continue, they initially see an IronPort notification page with a warning about accessing sites of this category. The end-user URL category warning page includes a “continue” hypertext link to the originally requested URL. With this continue option, the end-user can review the company's acceptable use policy and, if desired, continue accessing the blocked site. End-user actions are appropriately logged.

For more information, see “Warning Users and Allowing Them to Continue” on page 306.

Enhanced: Authentication

AsyncOS 6.0 for Web includes several changes and enhancements to authentication.

Re-Authentication

In AsyncOS for Web 6.0, it is possible for a user to re-authenticate when blocked from accessing a web site due to restrictive URL filtering. Users can enter different authentication credentials that allow broader access. To do this, enable the “Enable Re-Authentication Prompt If End User Blocked by URL Category” global authentication setting. This is useful in many situations including, for example, authenticating users on a shared workstation, or allowing a teacher to enter higher privileged credentials to provide access to restricted websites to students for a limited time.

For more information, see “Allowing Users to Re-Authenticate” on page 386.

Guest Access (Failed Authentication)

Sometimes, users do not have an account in an organization's user directory. Examples of such users include visitors, contractors, interns, and students pursuing a short course. AsyncOS for Web 6.0 allows you to define policies for these users who fail authentication due to invalid credentials. Users who fail authentication and are granted access are logged in as guests, and their activities are logged by user name (as entered by the user) or IP address.

To grant guest access to users who fail authentication, you create an Identity that requires authentication, but also allows guest privileges. Then you create another policy using that Identity and apply that policy to the guest users. When users have guest access, they can access the resources defined in the policy group that specifies guest access for that Identity. Typically, guest policies allow for limited access to web resources.

For more information, see “Allowing Guest Access to Users Who Fail Authentication” on page 155.

NTLM Authentication Caching

In previous versions, when the Web Security appliance used cookie-based NTLMSSP authentication, users were authenticated against the Active Directory server every time they made a request to a new domain. Now in AsyncOS for Web 6.0, the Web Security appliance uses authentication caching to reduce the load on the Active Directory server. It does this by adding a master cookie to the request when the user is authenticated for the first time. Subsequent requests get authenticated by validating the cookie, and frequent requests to the Active Directory server are avoided, improving overall authentication performance.

Active Directory 2008 Support

AsyncOS for Web 6.0 supports Active Directory 2008, without requiring an older version of Active Directory in the network.

Surrogates in Explicit Forward Mode

In previous versions, you could configure authentication surrogates for caching authentication credentials in transparent mode or when secure client authentication (now known as credential encryption) was enabled. Authentication surrogates allow you to associate transactions with a user either by IP address or cookie after the user has authenticated successfully.

In AsyncOS for Web 6.0, you can configure authentication surrogates for both transparent and explicit forward deployments whether or not credential encryption is enabled.

For more information, see “Configuring Global Authentication Settings” on page 373 and see “Tracking Authenticated Users” on page 389.

User Attribute Based Authentication

In AsyncOS for Web 6.0, when you enable group authorization in an LDAP authentication realm, you can group users by the LDAP user object as well as by group object. In previous

versions, you could group users by group object only. The user object contains all the groups to which a user belongs.

For more information, see “LDAP Group Authorization” on page 393.

Enhanced: Logging

AsyncOS 6.0 for Web includes several changes and enhancements to Web Security appliance logging to help you troubleshoot issues more easily.

W3C Standard Extended Log File Format Access Logs

In AsyncOS for Web 6.0, the Web Security appliance supports the W3C standard extended log file format (ELFF) for access log information. The W3C access log subscriptions record Web Proxy transaction history in a format that is readable by generic analysis tools. The extended log file format is self-describing, so your analysis tool can read the log fields in use and present them in an understandable format.

You can create multiple W3C access log subscriptions and define the data to include in each. You might want to create one W3C access log that includes all information your organization typically needs, and other, specialized W3C access logs that can be used for troubleshooting purposes or special analysis. For example, you might want to create a W3C access log for an HR manager that only needs access to certain information.

For more information, see “W3C Compliant Access Logs” on page 467.

Enhanced HTTPS Logging

AsyncOS for Web 6.0 includes enhanced logging of HTTPS transaction for easier troubleshooting. To view more detail HTTPS transaction details, increase the HTTPS log level detail to either Debug or Trace. With this feature, the HTTPS logs show various SSL handshake phases, such as establishing capabilities, server authentication and key exchange, client key exchange, and finalizing of the SSL handshake. Additionally, session information like server certificate, client certificate, certificate chain, key size, cipher used, and certificate verification message is also logged.

New Log File Types

AsyncOS 6.0 for Web includes the following new types of log files:

- **Data Security Logs.** Records client history for upload requests that are evaluated by the IronPort Data Security Filters. For more information, see “Logging” on page 254.
- **Data Security Module Logs.** Records messages related to the IronPort Data Security Filters. The Data Security Module Logs are one of the Web Proxy module log types containing more detailed information for troubleshooting purposes.
- **FTP Proxy Logs.** Records error and warning messages related to the FTP Proxy. The FTP Proxy Logs are one of the Web Proxy module log types containing more detailed information for troubleshooting purposes.
- **W3C Access Logs.** Records Web Proxy client history in a W3C compliant format.

For more information, see “Log File Types” on page 442.

Enhanced: Accelerated AsyncOS Upgrades

In AsyncOS 6.0 for Web, the IronPort update servers have a distributed architecture so customers can quickly download AsyncOS upgrades wherever in the world they are located. When configuring your system for AsyncOS upgrades, you can choose to stream upgrades directly to your IronPort appliances or set up a local server to host upgrades.

For more information, see “Upgrading the System Software” on page 537 and “Configuring Upgrade and Service Update Settings” on page 539.

HOW TO USE THIS GUIDE

Use this guide as a resource to learn about the features of your IronPort appliance. The topics are organized in a logical order. You might not need to read every chapter in the book.

You can also use this guide as a reference book. It contains important information, such as network and firewall configuration settings, that you can refer to throughout the life of the appliance.

The guide is distributed in print and electronically as PDF and HTML files. The electronic versions of the guide are available on the IronPort Customer Support Portal. You can also access the HTML online help version of the book directly from the appliance GUI by clicking the Help and Support link in the upper-right corner.

Before You Begin

Before you read this guide, review the *IronPort Quickstart Guide* and the latest product release notes for your appliance. In this guide, it is assumed that you have unpacked the appliance, physically installed it in a rack, and turned it on.

Note — If you have already cabled your appliance to your network, ensure that the default IP address for the IronPort appliance does not conflict with other IP addresses on your network. The IP address that is pre-configured on the Management port is 192.168.42.42.

Typographic Conventions

Typeface	Meaning	Examples
AaBbCc123	The names of commands, files, and directories; on-screen computer output.	Please choose an IP interface for this Listener. The <code>sethostname</code> command sets the name of the IronPort appliance.
AaBbCc123	User input, in contrast to on-screen computer output.	mail3.example.com> commit Please enter some comments describing your changes: []> Changed the system hostname
<i>AaBbCc123</i>	Book titles, new terms, emphasized words, and command line variables; for command line variables, the italicized text is a placeholder for the actual name or value.	Read the <i>IronPort Quickstart Guide</i> . The IronPort appliance <i>must</i> be able to uniquely select an interface to send an outgoing packet. Before you begin, please reset your password to a new value. Old password: ironport New password: <i>your_new_password</i> Retype new password: <i>your_new_password</i>

Where to Find More Information

IronPort offers the following resources to learn more about the Web Security appliance.

Documentation Set

The documentation for the Web Security appliance includes the following books:

- *IronPort AsyncOS for Web User Guide* (this book)
- *IronPort AsyncOS CLI Reference Guide*

Occasionally, this book refers to the other guides for additional information about topics.

IronPort Technical Training

Cisco IronPort Systems Technical Training Services can help you acquire the knowledge and skills necessary to successfully evaluate, integrate, deploy, maintain, and support IronPort security products and solutions.

Use one of the following methods to contact Cisco IronPort Technical Training Services:

Training. For question relating to registration and general training:

- <http://training.ironport.com>
- training@ironport.com

Certifications. For questions relating to certificates and certification exams:

- <http://training.ironport.com/certification.html>
- certification@ironport.com

Knowledge Base

You can access the IronPort Knowledge Base on the Customer Support Portal at the following URL:

<http://www.cisco.com/cisco/web/support/index.html>

The Knowledge Base contains a wealth of information on topics related to IronPort products.

Articles generally fall into one of the following categories:

- **How-To.** These articles explain how to do something with an IronPort product. For example, a how-to article might explain the procedures for backing up and restoring a database for an appliance.
- **Problem-and-Solution.** A problem-and-solution article addresses a particular error or issue that you might encounter when using an IronPort product. For example, a problem-and-solution article might explain what to do if a specific error message is displayed when you upgrade to a new version of the product.
- **Reference.** Reference articles typically provide lists of information, such as the error codes associated with a particular piece of hardware.
- **Troubleshooting.** Troubleshooting articles explain how to analyze and resolve common issues related to IronPort products. For example, a troubleshooting article might provide steps to follow if you are having problems with DNS.

Each article in the Knowledge Base has a unique answer ID number.

IronPort Customer Support

You can request IronPort product support by phone, email, or online 24 hours a day, 7 days a week.

During Customer Support hours — 24 hours a day, Monday through Friday, excluding U.S. holidays — an engineer will contact you within an hour of your request.

To report a critical issue that requires urgent assistance outside of Customer Support hours, contact IronPort using one of the following methods:

U.S. Toll-free: 1 (877) 641-4766

International: <http://cisco.com/web/ironport/contacts.html>

Support Portal: <http://www.cisco.com/cisco/web/support/index.html>

If you purchased support through a reseller or another supplier, please contact that supplier directly with your product support issues.

IronPort Welcomes Your Comments

The IronPort Technical Publications team is interested in improving the product documentation. Your comments and suggestions are always welcome. You can send comments to the following email address:

docfeedback@ironport.com

Please include the following part number in the subject of your message: 421-0172.

WEB SECURITY APPLIANCE OVERVIEW

The Web Security appliance is a robust, secure, efficient device that protects corporate networks against web-based malware and spyware programs that can compromise corporate security and expose intellectual property. The Web Security appliance extends IronPort's SMTP security applications to include protection for standard communication protocols, such as HTTP, HTTPS, and FTP.

Malware ("malicious software") is software designed to infiltrate or damage a computer system without the owner's consent. It can be any kind of hostile, intrusive, or annoying software or program code. Web-based malware includes spyware, system monitors, adware, phishing and pharming techniques, keystroke (key) loggers, browser hijackers, trojan horses, and more.

Web-based malware is a rapidly growing threat, responsible for significant corporate downtime, productivity losses and major strains on IT resources. Additionally, companies run the risk of violating compliance and data privacy regulations if their networks become compromised by malware. Companies run the risk of expensive legal costs and exposure of intellectual property.

The best place to stop these threats from entering the network is right at the gateway. The Web Security appliance provides deep application content inspection, by offering a web proxy service and by monitoring layer 4 traffic. The Web Proxy and Layer 4 Traffic Monitor allow organizations to ensure breadth of coverage within their networks. The Web Security appliance provides a powerful web security platform to protect your organization against malware that is optimized for performance and efficacy.

Using the Web Security Appliance

This chapter contains the following topics:

- “How the Web Security Appliance Works” on page 16
- “Administering the Web Security Appliance” on page 17
- “Navigating the Web Security Appliance Web Interface” on page 19
- “Committing and Clearing Changes” on page 25

HOW THE WEB SECURITY APPLIANCE WORKS

The Web Proxy and the L4 Traffic Monitor are independent services. They are enabled and configured separately to provide the highest level of protection against a broad range of web-based malware threats.

The Web Proxy and L4 Traffic Monitor use data that is stored in filtering tables to evaluate and match URL request attributes such as domain names, and IP address path segments with locally maintained database records. If a match occurs, Access Policy settings determine an action to block or monitor the traffic. If no match occurs, processing continues.

Web Proxy

The Web Security appliance Web Proxy supports the following security features:

- Policy groups — Policy groups allow administrators to create groups of users and apply different levels of category-based access control to each group.
- IronPort URL Filtering Categories — You can configure how the appliance handles each web transaction based on the URL category of a particular HTTP request.
- Web Reputation Filters — Reputation filters analyze web server behavior and characteristics to identify suspicious activity and protect against URL-based malware threats.
- Anti-Malware Services — The IronPort DVS™ engine in combination with the Webroot™ and McAfee scanning engines identify and stop a broad range of web-based malware threats.

For detailed information about Web Proxy services, see “Web Proxy Services” on page 85.

The L4 Traffic Monitor

The L4 Traffic Monitor is a configurable service that listens and monitors network ports for rogue activity and blocks malware attempts to infect your corporate network. Additionally, the L4 Traffic Monitor detects infected clients and stops malicious activity from going outside the corporate network.

For detailed information about the L4 Traffic Monitor, see “L4 Traffic Monitor” on page 405.

ADMINISTERING THE WEB SECURITY APPLIANCE

You can manage the Web Security appliance using a web-based administration tool. When you first access the appliance, the web interface launches the System Setup Wizard to perform an initial configuration. After running the System Setup Wizard, you can use the web interface or Command Line Interface (CLI) to customize settings and maintain your configuration.

For a description of how to access the CLI and a list CLI supported commands, see “Command Line Interface” on page 547.

System Setup Wizard

The System Setup Wizard is a utility that configures basic settings and enables a set of system defaults. The System Setup Wizard is located on the System Administration tab. For more information about running the System Setup Wizard, see “System Setup Wizard” on page 51.

Note — Running the System Setup Wizard completely reconfigures the Web Security appliance and resets the administrator password. Only use the System Setup Wizard the first time you install the appliance, or if you want to completely overwrite the existing configuration. Running the System Setup Wizard after the appliance is already configured can also interrupt client access to the web. If you choose to run the System Setup Wizard after performing an initial setup, use the System Administration > Configuration File pages to print a configuration summary and archive the current configuration file.

Accessing the Web Security Appliance

To access the appliance and launch the web-based administration utility, open a web browser. For the list of supported web browsers, see “Browser Requirements” on page 21.

Connect to the management interface using one of the following methods:

- IP address and port number

```
https://192.168.42.42:8443
```

where `192.168.42.42` is the default IP address, and `8443` is default admin port for HTTPS.

- Host name and port number

```
https://hostname:8443
```

where `hostname` is the name of the appliance, and `8443` is default admin port for HTTPS.

Note — The hostname parameter is assigned during system setup. Before you can connect to the management interface using a hostname, you must add the appliance hostname and IP address to your DNS server database.

For information about how to use and navigate the web interface, see “Navigating the Web Security Appliance Web Interface” on page 19.

Using the Command Line Interface (CLI)

You can establish an SSH or serial console connection to administer the appliance using the CLI. The Web Security appliance CLI supports a set of commands to access, install, and administer the system. See “Command Line Interface” on page 547 for information about the CLI and a list of supported commands that can be used to access, upgrade, and administer the appliance.

The SenderBase Network

The SenderBase Network is a threat management database that tracks millions of domains around the world and maintains a global watch list for Internet traffic. SenderBase provides IronPort with an assessment of reliability for known Internet domains. The Web Security appliance uses the SenderBase data feeds to improve the accuracy of Web Reputation Scores.

Basic SenderBase Network Participation is enabled by default during system setup. The appliance supports three levels of participation in the SenderBase Network:

- **Disabled.** Participation is disabled and none of the data that the appliance collects is sent back to the SenderBase Network servers.
- **Limited.** Basic participation summarizes server name information and sends MD5-hashed path segments to the SenderBase Network servers.
- **Standard.** Enhanced participation sends the entire URL with unobfuscated path segments to the SenderBase Network servers. This option assists in providing a more robust database, and continually improves the integrity of Web Reputation Scores.

To select a level of participation in the SenderBase Network, use the Security Services > SenderBase page.

Sharing Data

Participating in the SenderBase Network means that IronPort collects data and shares that information with the SenderBase threat management database. This data includes information about request attributes and how the appliance handles requests.

IronPort recognizes the importance of maintaining your privacy, and does not collect or use personal or confidential information such as usernames and passwords. Additionally, the file names and URL attributes that follow the hostname are obfuscated to ensure confidentiality. When it comes to decrypted HTTPS transactions, the SenderBase Network only receives the IP address, web reputation score, and URL category of the server name in the certificate.

If you agree to participate in the SenderBase Network, data sent from your IronPort appliance is transferred securely using HTTPS. Sharing data improves IronPort’s ability to react to web-based threats and protect your corporate environment from malicious activity.

Reporting and Logging

The Web Security appliance provides several options for capturing data and monitoring system activity. For detailed information about scheduling reports, see “Reporting Overview” on page 434. For more information about working with log files, see “Logging” on page 441.

NAVIGATING THE WEB SECURITY APPLIANCE WEB INTERFACE

The Web Security appliance web interface is a web-based administration tool that allows you to configure and monitor the appliance. The web interface allows you to configure the appliance similar to the Command Line Interface (CLI). However, some features available in the web interface are not available in the CLI and vice versa. For more information about the CLI, see “Command Line Interface” on page 547.

The Web Security appliance web interface contains multiple tabs where you can configure or monitor the appliance. You can set up Access Policies, schedule reports, enable features, and modify settings as necessary. The web interface also includes two menus from which you can perform basic administration tasks.

To use the web interface, open a web browser and log in. For more details, see “Accessing the Web Security Appliance” on page 17. For a list of supported web browsers, see “Browser Requirements” on page 21.

The web interface contains the following menus:

- **Options.** From this menu, you can manage your user account. You can logout or change the password you use to log in to the web interface.
- **Help.** From this menu, you can access help from documentation or IronPort Customer Support. For Help tasks, you can access the online help or the IronPort Support Portal. For Technical Support tasks, you can send a support request email to IronPort Customer Support or to allow IronPort Customer Support remote access to the Web Security appliance. For more information about the Technical Support tasks, see “Support Commands” on page 509.

The web interface contains the following tabs:

- **Monitor.** Use the pages on this tab to monitor the appliance by viewing dynamic data on website activity and appliance activity and action. For more information, see “Monitor Tab” on page 21.
- **Web Security Manager.** Use the pages on this tab to create and configure Access Policies that define which groups can access which types of websites. For more information, see “Web Security Manager Tab” on page 22.
- **Security Services.** Use the pages on this tab to configure how the appliance monitors and secures the network. For more information, see “Security Services Tab” on page 22.
- **Network.** Use the pages on this tab to define the network in which the appliance is located. For more information, see “Network Tab” on page 23.
- **System Administration.** Use the pages on this tab to configure administrative options, such as users, alerts, system time, and more. You can also enter keys for features you enabled during initial setup. For more information, see “System Administration Tab” on page 23.

Each tab has a list of menu selections from which you can choose. Each menu selection represents a different page in the web interface that further group information and activities. Some pages are grouped together into categories. You navigate among sections of the web interface by hovering the cursor over each tab heading and clicking a menu option from the menu that appears.

You open up other pages in the web interface by clicking on hypertext links and buttons. To find the various links, hover the cursor over text in the web interface. Links appear with an underline under the text when the cursor is over them.

Figure 2-1 on page 20 shows the web interface tabs, pages, and categories. It also shows some sample links and buttons you can click to open up other pages where you can configure the appliance.

Figure 2-1 Web Interface Tabs, Pages, and Categories

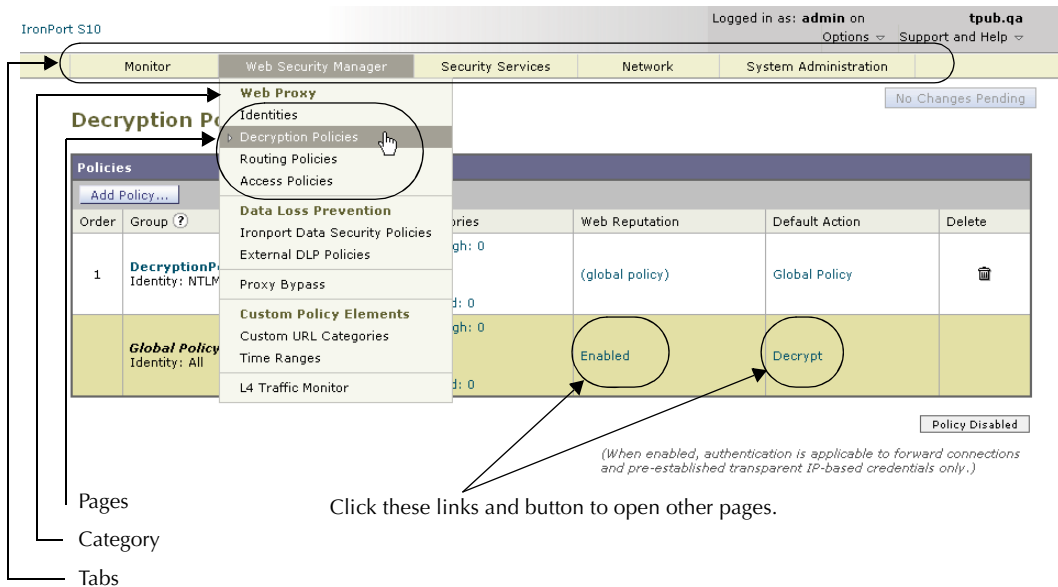

Figure 2-1 shows that the Web Security Manager tab contains the Web Proxy category, and the Web Proxy category contains the Identities, Decryption Policies, Routing Policies, Access Policies, and Bypass List pages. The tab also contains the Custom Policy Elements category (with the Custom URL Categories page), and the L4 Traffic Monitor page.

When the documentation refers to specific pages in the web interface, it uses the tab name, following by an arrow and then the page name. For example, Web Security Manager > Access Policies.

Logging In

All users accessing the web interface must log in. Type your username and password, and then click Login to access the web interface. You must use a supported web browser (see “Browser Requirements” on page 21). You can log in with the admin account or any other user account created in the appliance. For more information creating appliance users, see “Administering User Accounts” on page 517.

After you log in, the Monitor > Overview page displays.

Browser Requirements

To access the web interface, your browser must support and be enabled to accept JavaScript and cookies. It must be able to render HTML pages containing Cascading Style Sheets (CSS). For example, you can use the following browsers:

- Firefox 1.0 and later
- Internet Explorer 6.02 and later (Windows only)
- Mozilla 1.76 and later
- Netscape 7.1 and later
- Safari 2.0.4 and later (Mac OS X only)

Your session automatically times out after 30 minutes of inactivity.

Some buttons and links in the web interface cause additional windows to open. Therefore, you may need to configure the browser’s pop-up blocking settings in order to use the web interface.

Note — Only use one browser window or tab at a time to edit the appliance configuration. Also, do not edit the appliance using the web interface and the CLI at the same time. Editing the appliance from multiple places concurrently results in unexpected behavior and is not supported.

Monitor Tab

Use the Monitor tab to monitor the appliance by viewing dynamic data on website activity and appliance activity and action.

The Monitor tab includes the following pages:

- Overview
- L4 Traffic Monitor
- Web Activity
- Malware Risk
- Web Site Activity
- Anti-Malware

- URL Categories
- Web Reputation Filters
- System Status
- Report Scheduling
- Archived Reports

Web Security Manager Tab

Use the Web Security Manager tab to create and configure Access Policies that define which groups can access which types of websites.

The Web Security Manager tab includes the following pages:

- Identities
- Decryption Policies
- Routing Policies
- Access Policies
- IronPort Data Security Policies
- External DLP Policies
- Proxy Bypass
- Custom URL Categories
- Time Ranges
- L4 Traffic Monitor

Security Services Tab

Use this tab to configure how the appliance monitors and secures the network.

The Security Services tab includes the following pages:

- Proxy Settings
- FTP Proxy Settings
- HTTPS Proxy
- End-User Notification
- PAC File Hosting
- L4 Traffic Monitor
- Acceptable Use Controls
- Web Reputation Filters
- Anti-Malware

- IronPort Data Security Filters
- SenderBase

Network Tab

Use the Network tab to describe the network in which the appliance is located and to define the appliance's network settings.

The Network tab includes the following pages:

- Interfaces
- Transparent Redirection
- Routes
- Internal SMTP Relay
- Authentication
- Upstream Proxies
- External DLP Servers
- DNS

System Administration Tab

Use the System Administration tab to configure administrative options, such as users, alerts, system time, and more. You can also enter keys for features you enabled during initial setup.

The System Administration tab includes the following pages:

- Policy Trace
- Users
- Alerts
- Log Subscriptions
- Return Addresses
- Time Zone
- Time Settings
- Configuration Summary
- Configuration File
- Feature Key Settings
- Feature Keys
- Upgrade and Update Settings
- System Upgrade

- System Setup Wizard
- Next Steps

COMMITTING AND CLEARING CHANGES

When you change the configuration of the Web Security appliance, you must commit the changes before they go into effect. Or, you can choose to clear the changes you have made if you do not want to commit them. How you commit and clear changes depends on the interface you use:

- Web interface
- Command Line Interface

Committing and Clearing Changes in the Web Interface

Commit changes using the **Commit Changes** button in the upper right corner of the web interface. You can make multiple configuration changes before you commit all of them. When you make a change, the **Commit Changes** button color is yellow and the button text changes to “Commit Changes” as shown in Figure 2-2.

Figure 2-2 The Commit Button: Changes Pending



When there are no changes to commit, the button color is gray and the button text is “No Changes Pending.” Figure 2-3 shows the web interface when there are no changes to commit.

Figure 2-3 The Commit Button: No Changes Pending



You also use the **Commit Changes** button to clear the changes made since the last commit or clear.

Committing Changes

To commit changes made in the web interface:

1. Click the **Commit Changes** button.

The Uncommitted Changes page appears.

Uncommitted Changes

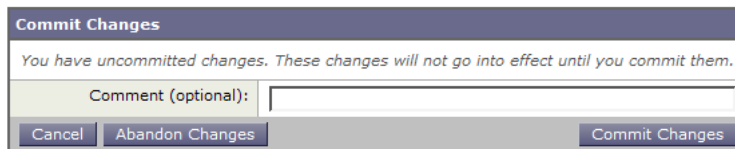

2. Enter comments in the Comment field if you choose.
3. Click **Commit Changes**.

Clearing Changes

To clear changes made in the web interface:

1. Click the **Commit Changes** button.
The Uncommitted Changes page appears.
2. Click **Abandon Changes**.

Committing and Clearing Changes in the CLI

Commit changes using the `commit` command. Most configuration changes you make in the Command Line Interface (CLI) are not effective until you issue the `commit` command. You may include comments up to 255 characters. Changes are not verified as committed until you receive confirmation along with a timestamp. The `commit` command applies configuration changes made to appliance since the last `commit` or `clear` command issued.

For more information about using the `commit` command, see “Committing Configuration Changes” on page 552.

Clear changes using the `clear` command. For more information about using the `clear` command, see “Clearing Configuration Changes” on page 552.

Deployment

This chapter contains the following topics:

- “Deployment Overview” on page 28
- “Appliance Interfaces” on page 30
- “Deploying the Web Proxy in Explicit Forward Mode” on page 33
- “Deploying the Web Proxy in Transparent Mode” on page 34
- “Connecting the Appliance to a WCCP Router” on page 35
- “Using the Web Security Appliance in an Existing Proxy Environment” on page 40
- “Deploying the L4 Traffic Monitor” on page 41
- “Physical Dimensions” on page 43

DEPLOYMENT OVERVIEW

The Web Security appliance is typically installed as an additional layer in the network between clients and the Internet. Depending on how you deploy the appliance, you may or may not need a Layer 4 (L4) switch or a WCCP router to direct client traffic to the appliance.

When you deploy the Web Security appliance, you can enable one or both of the following features:

- **Secure web proxy.** The appliance web proxy service monitors and scans web traffic for malicious content. When you enable the web proxy, you can configure it to be in transparent or explicit forward mode.
- **L4 Traffic Monitor.** The L4 Traffic Monitor detects and blocks rogue traffic across all ports and IP addresses. The L4 Traffic Monitor listens to network traffic that comes in over all ports and IP addresses on the appliance and matches domain names and IP addresses against entries in its own database tables to determine whether to allow outgoing traffic.

By default, both the L4 Traffic Monitor and Web Proxy are enabled in the System Setup Wizard. If you need to disable both or one of these features, you can do so after initial setup from the web interface.

The features you enable determine how you deploy and physically connect the appliance to the network. For more information about how the features you enable affect appliance deployment, see “Preparing for Deployment” on page 28. For more information about the Ethernet ports used to physically connect the appliance to the network, see “Appliance Interfaces” on page 30.

Preparing for Deployment

Before installing the Web Security appliance, read through the following questions and use the responses to each question to help you decide how to deploy the appliance and where to locate it in your network. Each response includes a reference to a different section that covers the response in more detail.

1. Will you deploy the Web Security appliance as a transparent proxy or an explicit forward proxy?
 - **Explicit Forward Proxy.** Client applications, such as web browsers, are aware of the Web Proxy and must be configured to point to a single Web Security appliance. This deployment requires a connection to a standard network switch. When you deploy the Web Proxy in explicit forward mode, you can place it anywhere in the network. For more information, see “Deploying the Web Proxy in Explicit Forward Mode” on page 33.
 - **Transparent Proxy.** Clients applications are unaware of the Web Proxy and do not have to be configured to connect to the proxy. This deployment requires an L4 switch or a WCCP v2 router. For more information, see “Deploying the Web Proxy in Transparent Mode” on page 34.

2. Does the network have an existing proxy?

If yes, it is recommended you deploy the Web Security appliance downstream from an existing proxy server, meaning closer to the clients. The System Setup Wizard refers to this as an upstream proxy configuration.

For more information, see “Using the Web Security Appliance in an Existing Proxy Environment” on page 40.

3. Will you enable the L4 Traffic Monitor?

L4 Traffic Monitor deployment is independent of the Web Proxy deployment. You can connect the L4 Traffic Monitor to a network tap or the mirror/span port of a switch.

For more information, see “Deploying the L4 Traffic Monitor” on page 41.

APPLIANCE INTERFACES

The Web Security appliance includes six physical Ethernet ports on the back of the system. Each Ethernet port corresponds to a different network interface. The Ethernet ports are grouped into the following types of network interfaces:

- **Management.** The Management interfaces include M1 and M2. However, only the M1 interface is enabled on the appliance. For more information, see “Management Interface” on page 30.
- **Data.** The Data interfaces include P1 and P2. Use the Data interfaces for Web Proxy data traffic. For more information, see “Data Interfaces” on page 30.
- **L4 Traffic Monitor.** The L4 Traffic Monitor interfaces include T1 and T2. Use these interfaces for monitoring and blocking L4 Traffic Monitor traffic. For more information, see “L4 Traffic Monitor Interfaces” on page 31.

Figure 3-1 shows the Ethernet ports on the back of the Web Security appliance blade.

Figure 3-1 Web Security Appliance Ethernet Ports

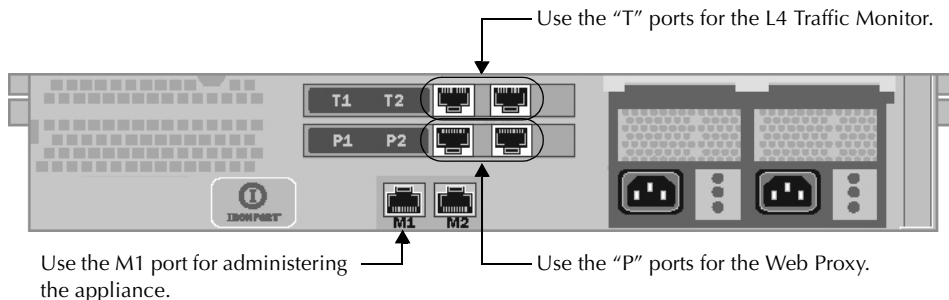

Management Interface

Use M1 to administer the appliance. Optionally, you can also configure the M1 interface to handle Web Proxy data traffic. You might want to use the M1 interface for data traffic if your organization does not use a separate management network. When M1 handles Web Proxy data traffic, neither of the data interfaces are enabled.

For more information about using the M1 port to set up and manage the appliance, see “Connecting a Laptop to the Appliance” on page 46.

For more information about configuring the network interfaces, see “Configuring Network Interfaces” on page 485.

Data Interfaces

The appliance uses the Data interfaces for Web Proxy data traffic. You can enable and use just the P1 port or both the P1 and P2 ports for data traffic.

- **P1 only enabled.** When only P1 is enabled, connect it to the network for both incoming and outgoing traffic.
- **P1 and P2 enabled.** When both P1 and P2 are enabled, you must connect P1 to the internal network and P2 toward the Internet.

Note — You can only enable and configure the P1 interface for data traffic in the System Setup Wizard. If you want to enable the P2 interface, you must do so after system setup in the web interface or using the `ifconfig` command. For more information about configuring the P2 interface, see “Configuring Network Interfaces” on page 485.

How you physically connect the data interfaces to the network depends on how you deploy the appliance. For more information, see “Deploying the Web Proxy in Explicit Forward Mode” on page 33 and “Deploying the Web Proxy in Transparent Mode” on page 34.

L4 Traffic Monitor Interfaces

The appliance uses the T1 and T2 interfaces for listening to traffic on all TCP ports. You can connect just T1 or both T1 and T2 using an Ethernet cable, depending on whether you use simplex or duplex communication.

- **T1 only connected (duplex).** When you configure the appliance to use duplex communication, connect T1 to the network so it receives all incoming and outgoing traffic.
- **T1 and T2 connected (simplex).** When you configure the appliance to use simplex communication, connect T1 to the network so it receives all outgoing traffic (from the clients to the Internet), and connect T2 to the network so it receives all incoming traffic (from the Internet to the clients).

For more information about how to connect the L4 Traffic Monitor ports to the network, see “Deploying the L4 Traffic Monitor” on page 41.

Example Deployment

Figure 3-2 on page 32 shows a sample deployment scenario with both the Web Proxy and L4 Traffic Monitor enabled. In this example, the Web Proxy is deployed in transparent mode and only the P1 port is connected to either a L4 switch or a WCCP router.

Figure 3-2 Web Security Appliance Deployment Scenario

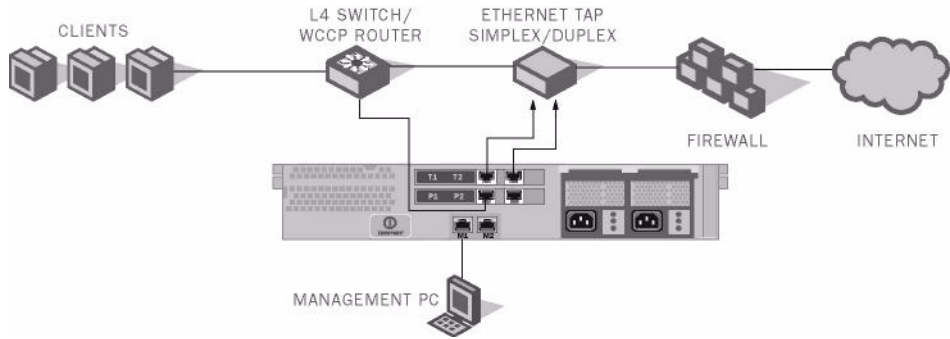

DEPLOYING THE WEB PROXY IN EXPLICIT FORWARD MODE

When the appliance is configured as an explicit forward proxy, client applications must be configured to direct its traffic to the appliance. When you want to configure the Web Proxy in explicit forward mode, you must configure the following components:

- Client applications
- Appliance ports

Tip — If your organization needs to use explicit forward mode now, but might need transparent mode in the future, consider deploying the Web Proxy in transparent mode and then choosing L4 switch as the connection type. If you do not have an L4 switch, you can connect the appliance to the network normally and the appliance will work in explicit forward mode. When the Web Proxy is deployed in transparent mode, it can accept both transparently redirected and explicitly forwarded transactions. To use transparent mode in the future, you can connect the appliance to an L4 switch and it will work in transparent mode without needing to change the Web Proxy mode later. However, it is easy to change the deployment mode at any time on the Security Services > Proxy Settings page.

Configuring Client Applications

You must configure all client applications, such as web browsers and FTP clients, used on the network to point to the Web Proxy. You can configure each client in the following ways:

- **Manual.** Configure each client application to point the appliance Web Proxy by specifying the appliance host name or IP address and the port number, such as 3128, used for listening to data traffic.
- **Automatic.** Configure each client application to use a PAC file to detect the appliance Web Proxy automatically. Then you can edit the PAC file to specify the appliance Web Proxy information. PAC files work with web browsers only. For more information, see “Working with PAC Files” on page 102.

Connecting Appliance Interfaces

You can connect the P1 interface or both the P1 and P2 interfaces to a network switch using an Ethernet cable. You do not need special hardware, such as a particular switch or router. For more information about how to connect the data interfaces (P1 and P2), see “Data Interfaces” on page 30.

Testing an Explicit Forward Configuration

If you want to test an explicit forward proxy configuration, you can separate and forward traffic from a subset of your network infrastructure. To individually test this configuration, clients can forward traffic to the appliance from one web browser and connect to the Internet using another web browser. This method also ensures an alternate path to the Internet while testing.

DEPLOYING THE WEB PROXY IN TRANSPARENT MODE

When the appliance is configured as a transparent proxy, client applications are not aware that their traffic gets redirected to the appliance, and they do not need to be configured to point to the appliance. To deploy the appliance in this mode, you need one of the following types of hardware to transparently redirect web traffic to the appliance:

- **WCCP v2 router.** When you specify a WCCP router, you need to configure additional settings on the appliance. For more information about using the appliance with a WCCP router, see “Connecting the Appliance to a WCCP Router” on page 35.
- **Layer 4 switch.** When you specify an L4 switch, you only need to specify that the appliance is connected to an L4 switch when you configure the appliance. You do not need to configure anything else on the appliance.

Typically, you configure the appliance to use an L4 switch or a WCCP v2 router during initial system setup. However, you can configure it to use either an L4 switch or a WCCP v2 router anytime after initial setup on the Network > Transparent Redirection page. For more information about the Network > Transparent Redirection page, see “Configuring Transparent Redirection” on page 495.

Connecting Appliance Interfaces

When you configure the Web Proxy in transparent mode, you can connect the P1 port or both the P1 and P2 ports to an L4 switch or WCCP router using an Ethernet cable. For more information about how to connect the data interfaces (P1 and P2), see “Data Interfaces” on page 30.

CONNECTING THE APPLIANCE TO A WCCP ROUTER

When you connect the appliance to a WCCP router, you must perform the following tasks:

1. You must create at least one WCCP service on the appliance. For more information, see “Configuring the Web Security Appliance” on page 35.
2. After you create a WCCP service, you must configure the router to work with the Web Security appliance. For more information, see “Configuring the WCCP Router” on page 35.

You can also connect an appliance to multiple WCCP routers. For more information, see “Working with Multiple Appliances and Routers” on page 39.

Configuring the Web Security Appliance

A WCCP service is an appliance configuration that defines a service group to a WCCP v2 router. It includes information such as the service ID and ports used. Service groups allow a web proxy to establish connectivity with a WCCP router and to handle redirected traffic from the router.

Create WCCP services on the Network > Transparent Redirection page. The WCCP services you create determine how you configure the WCCP routers. For more information about creating WCCP services, see “Adding and Editing a WCCP Service” on page 498.

Note — You can enable the standard service (also known as the “web-cache” service) during system setup, and you can configure different or additional WCCP service groups after you run the System Setup Wizard.

Configuring the WCCP Router

After you create at least one WCCP service in the Web Security appliance, you can configure the WCCP router(s) in the network.

Use the following syntax for enabling WCCP on the router:

```
ip wccp version 2
ip wccp service_group
interface interface_type_number
ip wccp service_group redirect direction
ip wccp service_group password password
```

Enter one of the following values for the *service_group* variable:

- **web-cache.** Enter “web-cache” when the appliance WCCP service uses the standard service.
- **Service ID number.** Enter a number from 0 to 255 when the appliance WCCP service uses a dynamic service ID. The number should match the service ID number used in the appliance.

Table 3-1 describes each part of the WCCP configuration syntax for enabling WCCP on the router.

Table 3-1 WCCP Router Configuration Syntax for Enabling the Router

WCCP Configuration	Description
<code>ip wccp version 2</code>	Defines the version of WCCP to use on the router. You must specify version 2 to work with the Web Security appliance. This command is required.
<code>ip wccp service_group password password</code>	Specifies a service group to enable on the router. It also enables the WCCP service on the router. This command is required.
<code>interface interface_type_number</code>	Specifies an interface to configure and enters interface configuration mode. Enter the interface number for the <i>interface_type_number</i> variable. This command is required.
<code>ip wccp service_group redirect direction</code>	Enables WCCP redirection on the specified interface. Enter one of the following values for the <i>direction</i> variable: <ul style="list-style-type: none"> • in. Use <code>in</code> when you want the router to redirect packets as they enter the router. • out. Use <code>out</code> when you want the router to redirect packets right before they leave the router. This command is required.
<code>ip wccp service_group password password</code>	Sets a password on the router for the specified service group. This command is only required when the WCCP service defined on the appliance has password security enabled.

You can also configure a WCCP router to perform other tasks, such as the following:

- Configure the router from exclude redirecting traffic received on a particular interface.
- If the network uses multiple Web Security appliances, you can configure the router to determine which traffic should be directed to which appliance by using an access list. You might want to redirect only some of the network traffic to the appliance if you are evaluating the Web Security appliance.

Note — The Web Security appliance does not support using a multicast address in the WCCP service group. To use multiple routers in a service group, you must specify the IP address of each router in the service group and configure each router separately. You cannot register a router to a multicast address.

Example WCCP Configurations

This section shows some sample WCCP services defined in the appliance and the corresponding WCCP configuration you should use to configure the router that connects to the appliance.

Example 1

Suppose you have the WCCP service shown in Figure 3-3.

Figure 3-3 Example WCCP Service — Standard Service, No Password Required

Add WCCP v2 Service

WCCP v2 Service	
Service Profile Name:	web_cache
Service:	<input checked="" type="radio"/> Standard service ID: 0 web-cache (destination port 80) <input type="radio"/> Dynamic service ID: 0 0-255 Port numbers: 80 <small>(up to 8 port numbers, separated by commas)</small> <input checked="" type="radio"/> Redirect based on destination port <input type="radio"/> Redirect based on source port (return path) <small>For IP spoofing, define two services, one based on destination port and another based on source port (return path).</small> <input type="radio"/> Load balance based on server address <input type="radio"/> Load balance based on client address <small>Applies only if more than one Web Security Appliance is in use.</small>
Router IP Addresses:	10.1.1.1 <small>Separate multiple entries with line breaks or commas.</small>
Router Security:	<input type="checkbox"/> Enable Security for Service Password: <input type="text"/> Confirm Password: <input type="text"/>
Advanced:	Load-Balancing Method: <input type="text" value="Allow Hash or Mask"/> Forwarding Method: <input type="text" value="Allow GRE or L2"/> Return Method: <input type="text" value="Allow GRE or L2"/>

In this example, the WCCP service defines the standard service group (also known as a well known service group). The redirection basis is on the destination port by default. Also suppose in this example that you want to configure the ethernet1 interface on the router for this service group.

Use the following WCCP configuration for this example:

```
ip wccp version 2
ip wccp web-cache
interface ethernet1
ip wccp web-cache redirect in
```

Example 2

Figure 3-4 shows a dynamic service you might create when IP spoofing is enabled and the WCCP service shown in Figure 3-3 on page 37 is defined.

Figure 3-4 Example WCCP Service — Dynamic Service for IP Spoofing

Add WCCP v2 Service

WCCP v2 Service	
Service Profile Name:	return_web
Service:	<input type="radio"/> Standard service ID: 0 web-cache (destination port 80) <input checked="" type="radio"/> Dynamic service ID: 90 0-255 Port numbers: 80 <small>(up to 8 port numbers, separated by commas)</small> <input checked="" type="radio"/> Redirect based on destination port <input type="radio"/> Redirect based on source port (return path) <small>For IP spoofing, define two services, one based on destination port and another based on source port (return path).</small> <input checked="" type="radio"/> Load balance based on server address <input type="radio"/> Load balance based on client address <small>Applies only if more than one Web Security Appliance is in use.</small>
Router IP Addresses:	10.1.1.1 <small>Separate multiple entries with line breaks or commas.</small>
Router Security:	<input type="checkbox"/> Enable Security for Service Password: <input type="password"/> Confirm Password: <input type="password"/>
Advanced:	Load-Balancing Method: <input type="text" value="Allow Hash or Mask"/> Forwarding Method: <input type="text" value="Allow GRE or L2"/> Return Method: <input type="text" value="Allow GRE or L2"/>

In this example, the WCCP service defines a dynamic service group with service ID of 90. The redirection basis is on the source port so it can be used for the return path with IP spoofing enabled. Suppose in this example that you want to configure the ethernet0 interface on the router for this service group.

Use the following WCCP configuration for this example:

```
ip wccp version 2
ip wccp 90
interface ethernet0
ip wccp 90 redirect out
```

For more information about enabling IP spoofing when using a WCCP router, see “IP Spoofing when Using WCCP” on page 497.

Example 3

Suppose you have the WCCP service shown in Figure 3-5.

Figure 3-5 Example WCCP Service — Dynamic Service, Password Required

Add WCCP v2 Service

WCCP v2 Service	
Service Profile Name:	service80_443
Service:	<input type="radio"/> Standard service ID: 0 web-cache (destination port 80) <input checked="" type="radio"/> Dynamic service ID: 120 0-255 Port numbers: 80, 443 <i>(up to 8 port numbers, separated by commas)</i> <input checked="" type="radio"/> Redirect based on destination port <input type="radio"/> Redirect based on source port (return path) <i>For IP spoofing, define two services, one based on destination port and another based on source port (return path).</i> <input checked="" type="radio"/> Load balance based on server address <input type="radio"/> Load balance based on client address <i>Applies only if more than one Web Security Appliance is in use.</i>
Router IP Addresses:	10.1.1.1, 10.5.5.5 <i>Separate multiple entries with line breaks or commas.</i>
Router Security:	<input checked="" type="checkbox"/> Enable Security for Service Password: ***** Confirm Password: *****
Advanced:	Load-Balancing Method: Allow Hash or Mask Forwarding Method: Allow GRE or L2 Return Method: Allow GRE or L2

In this example, the WCCP service defines a dynamic service group with service ID of 120. The redirection basis is on the destination port, and it has enabled a password for this service group of “admin99” (hidden in the appliance configuration). Also suppose in this example that you want to configure the ethernet0 interface on the router for this service group.

Use the following WCCP configuration for this example:

```
ip wccp version 2
ip wccp 120
interface ethernet0
ip wccp 120 redirect in
ip wccp 120 password admin99
```

Working with Multiple Appliances and Routers

When you connect one or more Web Security appliances to one or more WCCP routers, you have a cluster. You can include up to 32 appliances and up to 32 routers in a cluster. You must configure all appliances and routers in a cluster to communicate with each other.

USING THE WEB SECURITY APPLIANCE IN AN EXISTING PROXY ENVIRONMENT

The Web Security appliance is a proxy-compatible device, and is easily deployed within an existing proxy environment. However, it is recommended that you place the appliance downstream from existing proxy servers, meaning closer to the clients.

You can configure the appliance to work with an existing, upstream proxy in the System Setup Wizard or after the initial setup in the web interface. Use the Network > Upstream Proxies page to enable an upstream proxy or to modify existing settings.

When configuring an upstream proxy, you specify whether the existing proxy is in transparent or explicit forward mode.

Transparent Upstream Proxy

If a transparent upstream proxy uses client IP addresses to manage user authentication and access control, you must enable IP spoofing on the Web Security appliance to send client IP addresses to the upstream proxy. Use the Security Services > Proxy Settings page to enable IP spoofing.

When you enable IP spoofing and connect the appliance to a WCCP router, you must create at least two WCCP services. For more information about configuring WCCP services when you enable IP spoofing, see “IP Spoofing when Using WCCP” on page 497.

Explicit Forward Upstream Proxy

If the upstream proxy is in explicit forward mode, consider the following rules and guidelines:

- You must enter the IP address or host name and port of the upstream proxy.
- Consider whether the host name of the upstream proxy resolves to multiple IP addresses. The Web Security appliance only queries the DNS server for the IP address at startup. If an IP address is added or removed from that host name, the proxy must restart to resolve and add the host name to the new set of IP addresses.
- If the upstream proxy manages user authentication or access control using proxy authentication, you must enable the X-Forwarded-For header to send the client host header to the upstream proxy. Use the Security Services > Proxy Settings page to enable the X-Forwarded-For header setting.
- If you want to send authentication credentials to an upstream proxy when the Web Security appliance is deployed in explicit forward mode, you must configure the Web Proxy to forward authorization request headers to a parent proxy server using the `advancedproxyconfig > authentication` CLI command.

Note — By default, the Web Proxy does not forward proxy authorization headers to upstream proxy servers for security reasons.

- If the upstream proxy manages client traffic using a PAC file or a login script, you must update these files to use the IP address or host name of the Web Security appliance.

DEPLOYING THE L4 TRAFFIC MONITOR

L4 Traffic Monitor (L4TM) deployment is independent of the Web Proxy deployment. When connecting and deploying the L4 Traffic Monitor, consider the following:

- **Physical connection.** You can choose how to connect the L4 Traffic Monitor to the network. For more information, see “Connecting the L4 Traffic Monitor” on page 41.
- **Network address translation (NAT).** When configuring the L4 Traffic Monitor, connect it at a point in your network where it can see as much network traffic as possible before getting out of your egress firewall and onto the Internet. It is important that the L4 Traffic Monitor be ‘logically’ connected after the proxy ports and before any device that performs network address translation (NAT) on client IP addresses.
- **L4 Traffic Monitor action setting.** The default setting for the L4 Traffic Monitor is monitor only. After setup, if you configure the L4 Traffic Monitor to monitor and block suspicious traffic, ensure that the L4 Traffic Monitor and the Web Proxy are configured on the same network so that all clients are accessible on routes that are configured for data traffic.

Connecting the L4 Traffic Monitor

You can connect the L4 Traffic Monitor to the network in any of the following ways:

- **Network tap.** When you use a network tap, you can choose the following communication types:
 - **Simplex.** This communication type uses one cable for all traffic between clients and the appliance, and one cable for all traffic between the appliance and external connections. Connect port T1 to the network tap so it receives all outgoing traffic (from the clients to the Internet), and connect port T2 to the network tap so it receives all incoming traffic (from the Internet to the clients).
 - **Duplex.** This mode uses one cable for all incoming and outgoing traffic. You can use half- or full-duplex Ethernet connections. Connect port T1 to the network tap so it receives all incoming and outgoing traffic.

Note — IronPort recommends using simplex when possible because it can increase performance and security.

- **Span/mirror port of an L2 switch.** Connecting is similar to a simplex or duplex tap, depending on whether the connection uses two separate devices or one device.
- **Hub.** Choose duplex when you connect the L4 Traffic Monitor to a hub.

Regardless of how the appliance is connected to the network, you must configure the wiring type. For more information, see “Configuring an L4 Traffic Monitor Wiring Type” on page 42.

For more information about the T1 and T2 ports, see “Appliance Interfaces” on page 30.

Note — Use a network tap instead of the span/mirror port of a switch when possible. Network taps use hardware to move packets to the L4 Traffic Monitor and span and mirror ports of a

switch use software to move packets. Hardware solutions move packets with better performance than software solutions and are less likely to drop packets in the process.

Configuring an L4 Traffic Monitor Wiring Type

Typically, the L4 Traffic Monitor wiring type is configured during system setup. However, you can configure the wiring type after running the System Setup Wizard on the Network > Interfaces page. Click **Edit Settings** and select a wiring type for the T1 and T2 ports.

Figure 3-6 L4 Traffic Monitor Wiring Types

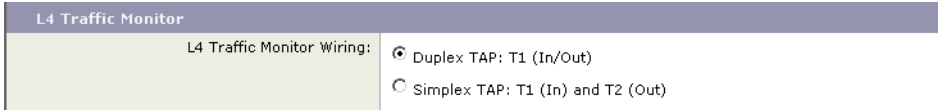

The screenshot shows a configuration window titled "L4 Traffic Monitor". Inside the window, there is a label "L4 Traffic Monitor Wiring:" followed by two radio button options. The first option, "Duplex TAP: T1 (In/Out)", is selected with a filled radio button. The second option, "Simplex TAP: T1 (In) and T2 (Out)", is unselected with an empty radio button.

L4 Traffic Monitor	
L4 Traffic Monitor Wiring:	<input checked="" type="radio"/> Duplex TAP: T1 (In/Out) <input type="radio"/> Simplex TAP: T1 (In) and T2 (Out)

PHYSICAL DIMENSIONS

The following physical dimensions apply to the **IronPort S660 and S360** Web Security appliances:

- Height: 8.656 cm (3.40 inches)
- Width: 48.26 cm (19.0 inches) with rails installed (without rails, 17.5 inches)
- Depth: 75.68cm (29.79 inches)
- Weight: maximum 25.6 kg (56.6 pounds)

The following physical dimensions apply to the **IronPort S160** Web Security appliance:

- Height: 4.2 cm (1.68 inches)
- Width: 48.26 cm (19.0 inches) with rails installed (without rails, 17.5 inches)
- Depth: 57.6 cm (22.7 inches)
- Weight: maximum 9.8 kg (21.6 pounds)

Installation and Configuration

This chapter contains the following topics:

- “Before You Begin” on page 46
- “System Setup Wizard” on page 51

BEFORE YOU BEGIN

To use the Web Security appliance, you must run the System Setup Wizard. However, first you must do some steps to prepare the appliance for the System Setup Wizard.

For more information about preparing the appliance for installation, see the Web Security appliance *QuickStart Guide*. You can find this guide and other useful information about the IronPort Web Security appliance Support Portal:

<http://www.cisco.com/cisco/web/support/index.html>

Complete the following tasks before you run the System Setup Wizard:

- **Deployment.** Decide how you are going to configure the appliance within your network. For details, see “Deployment” on page 27.
- **Laptop network connection.** Configure your laptop’s network connection to use an IP address on the same subnet as the Web Security appliance (192.168.42.xx). For details, see “Connecting a Laptop to the Appliance” on page 46.
- **Appliance physical connections.** Plug the Ethernet cables into the appropriate ports on the back panel of the appliance. For details, see “Connecting the Appliance to the Network” on page 46.
- **Setup information.** Once you know how you will install the appliance in your network, gather all the information, such as IP addresses, necessary for the System Setup Wizard. For details, see “Gathering Setup Information” on page 47.
- **Existing proxy server.** If you plan to use the Web Security appliance in a network that has an existing proxy server, you must locate it downstream from other proxy servers. Also, after you finish the initial setup of the appliance, you must configure it to work with the existing proxy server. For more information about deploying the appliance in a network with an existing proxy, see “Using the Web Security Appliance in an Existing Proxy Environment” on page 40.

Connecting a Laptop to the Appliance

In order to run the System Setup Wizard the first time, you must connect a computer, such as a laptop, to the appliance. To connect to the appliance, the laptop subnet must be the same as the appliance subnet. The Management ports are labeled M1 and M2. The Web Security appliance only uses the M1 Management port. It does not use M2.

Configure the laptop IP address so it is on the same subnet as the appliance (192.168.42.xx). Then, connect the laptop to the M1 port on the back of the appliance.

Connecting the Appliance to the Network

You must plug the Ethernet cables into the appropriate ports on the back panel of the appliance. For more information about the Ethernet ports on the appliance, see “Appliance Interfaces” on page 30.

How you deploy the appliance determines which Ethernet cables to plug in where:

- **Web proxy in transparent mode.** If you want to use one proxy port for all traffic, connect port P1 to an L4 switch or a WCCP router using an Ethernet cable. If you want to use two proxy ports for traffic, connect port P2 to an L4 switch or a WCCP router using an Ethernet cable, and connect port P1 to the internal network.

For more information about deploying the Web Proxy in transparent mode, see “Deploying the Web Proxy in Transparent Mode” on page 34.

Note — When you configure the proxy in transparent mode and connect it to a WCCP router, you must configure the appliance after you run the System Setup Wizard to create at least one WCCP service. For more information about creating WCCP services, see “Adding and Editing a WCCP Service” on page 498.

- **Web proxy in explicit forward mode.** If you want to use one proxy port for all traffic, connect port P1 to a network switch using an Ethernet cable. If you want to use two proxy ports for traffic, connect port P2 to a network switch using an Ethernet cable, and connect port P1 to the internal network.

For more information about deploying the Web Proxy in explicit forward mode, see “Deploying the Web Proxy in Explicit Forward Mode” on page 33.

- **L4 Traffic Monitor.** Connect the Traffic Monitor ports to the Ethernet tap according to the tap communication type:
 - **Ethernet tap using simplex.** Connect port T1 to the Ethernet tap so it receives all outgoing traffic (from the clients to the Internet), and connect port T2 to the Ethernet tap so it receives all incoming traffic (from the Internet to the clients).
 - **Ethernet tap using duplex.** Connect port T1 to the Ethernet tap so it receives all incoming and outgoing traffic.

For more information about deploying the L4 Traffic Monitor, see “Deploying the L4 Traffic Monitor” on page 41.

Gathering Setup Information

Once you know how you will install the appliance in your network, you can gather the necessary information, such as IP addresses, to enter in the System Setup Wizard. You can use the worksheet in Table 4-1 to write down the configuration options you decide on. Then, when you run the System Setup Wizard, you can use the information you enter in the worksheet to configure the initial setup.

Table 4-1 System Setup Worksheet

Network Settings	
Default System Host name:	See “DNS Support” on page 50 for more information.

Table 4-1 System Setup Worksheet (Continued)

DNS Servers:	Internet root DNS servers / organization DNS servers
Organization DNS Servers: (maximum 3)	1. 2. 3.
Network Time Protocol Server:	
Time Zone Region:	
Time Zone Country:	
Time Zone / GMT Offset:	
Network Context	
Is there another proxy on the network:	Yes / No
Other Proxy IP Address:	
Other Proxy Port:	
Interface Settings	
Management Port	
IP Address:	
Network Mask:	
Host Name:	
Data Port	
IP Address:	
Network Mask:	
Host Name:	
Note: The Web Proxy can share the Management interface. If configured separately, the Data interface IP address and the Management interface IP address cannot share the same subnet.	
L4 Traffic Monitor	
L4 Traffic Monitor Wiring Type:	Simplex network tap / Duplex network tap

Table 4-1 System Setup Worksheet (Continued)

Routes	
Management Traffic	
Default Gateway:	
Static Route Table Name:	
Static Route Table Destination Network:	
Static Route Table Gateway:	
Data Traffic	
Default Gateway:	
Static Route Table Name:	
Static Route Table Destination Network:	
Static Route Table Gateway:	
Transparent Connection Settings	
Device Type:	Layer 4 switch or No Device / WCCP Router
If WCCP v2 Router, enable standard service:	Yes / No
Standard Service Router Addresses:	
Enable Router Security?	No / Yes, password: _____
<p>Note: When you connect the appliance to a WCCP router, you might need to configure the Web Security appliance to create WCCP services after you run the System Setup Wizard. For more information about creating WCCP services, see "Adding and Editing a WCCP Service" on page 498.</p>	
Administrative Settings	
Administrator Password:	
Email System Alerts To:	
SMTP Relay Host:	(optional)
AutoSupport:	Enable / Disable

Table 4-1 System Setup Worksheet (Continued)

SenderBase Network Participation:	Enable / Disable
Participation Level:	Limited / Standard
Security Services	
L4 Traffic Monitor:	Monitor only / Block
Acceptable Use Controls:	Enable IronPort URL Filters / Enable Cisco IronPort Web Usage Controls / Disable
Web Reputation Filters:	Enable / Disable
Malware and Spyware Scanning:	Enable Webroot / Enable McAfee / Enable both
Action for Detected Malware:	Monitor only / Block
IronPort Data Security Filtering:	Enable / Disable

DNS Support

To connect to the management interface using a host name (<http://hostname:8080>), you must add the appliance host name and IP address to your DNS server database.

SYSTEM SETUP WIZARD

The IronPort AsyncOS for Web operating system provides a browser-based wizard to guide you through initial system configuration. This System Setup Wizard prompts you for basic initial configuration, such as network configuration and security settings. The System Setup Wizard is located on the System Administration tab.

You must run the System Setup Wizard when you first install the Web Security appliance. After you finish the System Setup Wizard, the appliance is ready to monitor web traffic. However, you may want to make more custom configurations to the appliance that the System Setup Wizard does not cover. For more information about configuration options, see most of the other chapters in this guide.

Before you run the System Setup Wizard, see “Before You Begin” on page 46 to verify you have all the information you need to configure the appliance. Having this information prepared ahead of time can reduce the amount of time required to complete the initial setup. You should also read the *QuickStart Guide* for more information about product setup.

WARNING: Running the System Setup Wizard completely reconfigures the Web Security appliance and resets the administrator password. Only use the System Setup Wizard the first time you install the appliance, or if you want to completely overwrite the existing configuration. Running the System Setup Wizard after the appliance is already configured can also interrupt client access to the web. If you choose to run the System Setup Wizard after performing an initial setup, use the System Administration > Configuration File pages to print a configuration summary and archive the current configuration file.

WARNING: The IronPort appliance ships with a default IP address of 192.168.42.42 on the Management interface (port). Before connecting the appliance to the network, ensure that no other device on the network has the same IP address.

If you are connecting multiple factory-configured IronPort appliances to your network, add them one at a time, reconfiguring each IronPort appliance’s default IP address as you go.

The System Setup Wizard includes the following tabs where you enter configuration information:

- **Start.** For details, see “Step 1. Start” on page 52.
- **Network.** For details, see “Step 2. Network” on page 52.
- **Security.** For details, see “Step 3. Security” on page 61.
- **Review.** For details, see “Step 4. Review” on page 63.

Accessing the System Setup Wizard

To access the System Setup Wizard, open a browser and enter the IP address of the Web Security appliance. The first time you run the System Setup Wizard, use the default IP address:

`https://192.168.42.42:8443`

where 192.168.42.42 is the default IP address, and 8443 is default admin port for HTTPS.

The appliance login screen appears. Enter the username and password to access the appliance. By default, the appliance ships with the following username and password:

- Username: **admin**
- Password: **ironport**

Note — Your session will time out if it is idle for over 30 minutes or if you close your browser without logging out. If this happens, you must re-enter the username and password.

Step 1. Start

When you first start the System Setup Wizard, it displays an end user license agreement.

1. Accept the terms of the agreement by clicking the check box at the bottom of the page.

Figure 4-1 System Setup Wizard — Start Tab

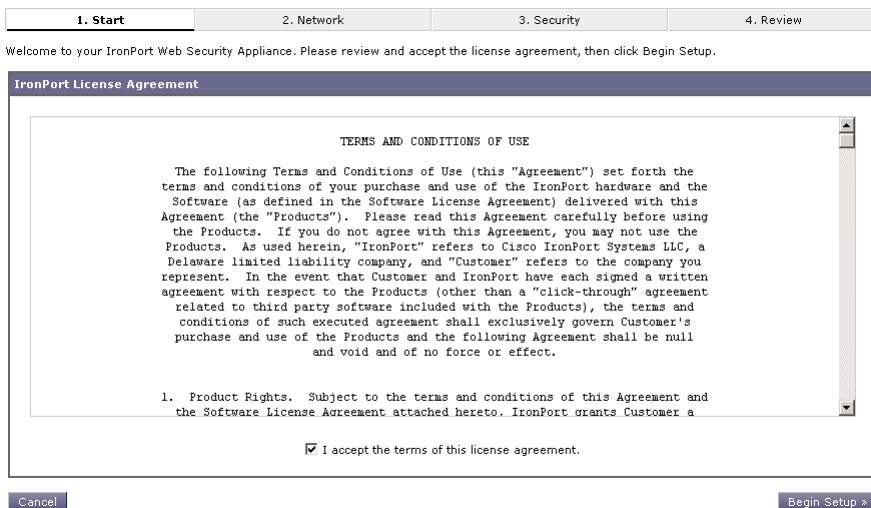

2. Click **Begin Setup** to continue.

The Network tab appears.

Step 2. Network

On the Network tab, you configure appliance system properties, such as the appliance host name and time zone. The first page of the Network tab is the System Settings page.

1. Verify that you are viewing the System Configuration page.

Figure 4-2 System Setup Wizard — Network Tab, System Settings

1. Start	2. Network	3. Security	4. Review
System Settings			
Default System Hostname: ?		wsa01.qa <i>e.g., proxy.company.com</i>	
DNS Server(s):		<input type="radio"/> Use the Internet's Root DNS Servers <input checked="" type="radio"/> Use these DNS Servers:	
		<input type="text" value="192.168.1.10"/> (optional) <input type="text"/> (optional)	
NTP Server:		time.ironport.com	
Time Zone:		Region: <input type="text" value="GMT Offset"/> Country: <input type="text" value="GMT"/> Time Zone / GMT Offset: <input type="text" value="GMT"/>	
<input type="button" value=" < Prev"/>		<input type="button" value=" Next >"/>	

2. Configure the System Setting options.

Table 4-2 describes the System Setting options.

Table 4-2 System Setting Options in System Setup Wizard

Option	Description
Default System Hostname	The fully-qualified hostname for the Web Security appliance. This name should be assigned by your network administrator. This hostname is used to identify the appliance in system alerts.
DNS Server(s): Use the Internet's Root DNS Servers	<p>Configures the appliance to use the Internet root DNS servers for domain name service lookups.</p> <p>You might choose this option when the appliance does not have access to DNS servers on your network.</p> <p>The appliance requires access to a working DNS server in order to perform DNS lookups for incoming connections. If you cannot specify a working DNS server that the appliance can reach while you set up the appliance, you can configure it to use the Internet root DNS servers or temporarily assign the IP address of the Management interface so that you can complete the System Setup Wizard.</p> <p>For more information about configuring DNS settings, see "Configuring DNS Server(s)" on page 504.</p>

Table 4-2 System Setting Options in System Setup Wizard (Continued)

Option	Description
DNS Server(s): Use these DNS Servers	Specifies local DNS servers for domain name service lookups. You must enter at least one DNS server, and up to three total. You can choose to use the Internet root DNS servers or specify your own DNS servers. For more information about configuring DNS settings, see “Configuring DNS Server(s)” on page 504.
NTP Server	Uses a Network Time Protocol (NTP) server to synchronize the system clock with other servers on the network or the Internet. By default, the IronPort Systems time server (time.ironport.com) is entered.
Time Zone	Sets the time zone on the IronPort appliance so that timestamps in message headers and log files are correct. Use the drop-down menus to locate your time zone or to define the time zone using the GMT offset. For more information about the GMT offset, see “Selecting a Time Zone” on page 532.

3. Click **Next**.

The Network Context page appears.

Figure 4-3 System Setup Wizard — Network Tab, Network Context Page

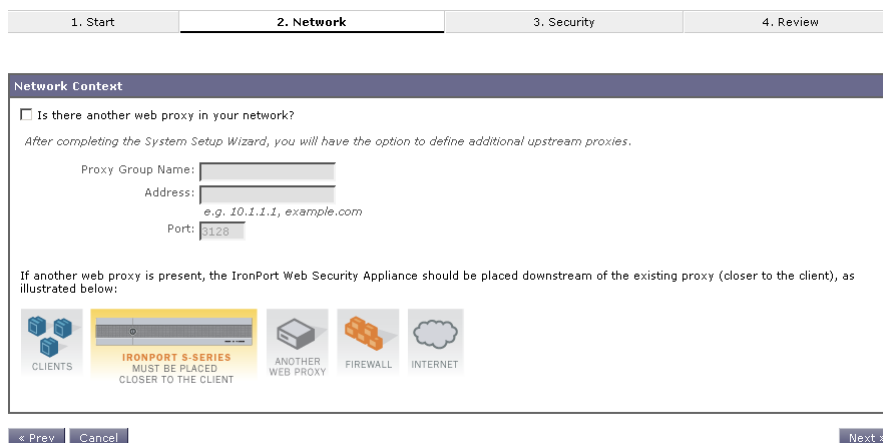

4. Configure the Network Context options by indicating whether or not there exists another proxy server on the network.

Note — You can configure the Web Security appliance to interact with multiple proxy servers on the network after you run the System Setup Wizard. For more information about configuring external proxy servers, see “Working with External Proxies Overview” on page 188.

5. If there is an external proxy server on the network, configure the proxy settings. Table 4-3 describes the proxy settings.

Table 4-3 Network Context Options in System Setup Wizard

Option	Description
Proxy group name	Choose a name for the proxy group.
Address	Enter the address of the proxy server in your organization network.
Port	The port number of the proxy server in your organization network.

The System Setup Wizard creates a proxy group with the information you provide in Table 4-3. You can edit the proxy group later to include additional proxy servers and to configure load balancing options. You can also create additional proxy groups after system setup.

Note — When you use the Web Security appliance in a network that contains another proxy server, it is recommended that you place the Web Security appliance downstream from the proxy server, closer to the clients.

6. Click **Next**.

The Network Interfaces and Wiring page appears.

The Web Security appliance has network interfaces that are associated with the physical ports on the machine.

Figure 4-4 System Setup Wizard — Network Tab, Network Interfaces and Wiring Page

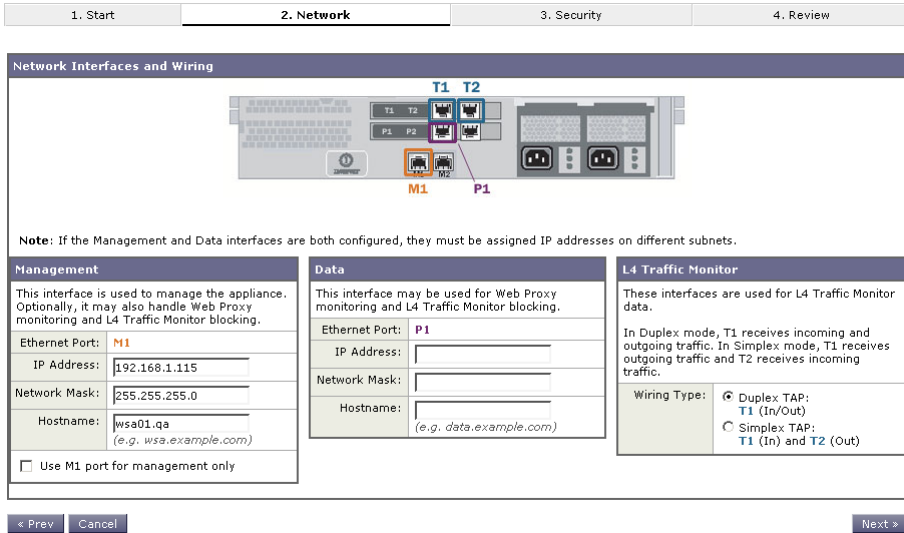

7. Configure the Network Interfaces and Wiring options.

The appliance has network interfaces that are associated with the physical ports on the machine. Table 4-4 describes the Network Interfaces and Wiring options.

Table 4-4 Network Interfaces and Wiring Options in System Setup Wizard

Option	Description
Management	<p>Enter the IP address, network mask, and hostname to use to manage the Web Security appliance. Enter an IP address that exists on your management network.</p> <p>By default, the appliance uses the M1 interface for both management and proxy (data) traffic (the “Use M1 port for management only” check box is <i>disabled</i>).</p> <p>However, optionally, you can use the M1 interface for only management traffic by enabling the “Use M1 port for management only” check box. You might want to do this if your organization uses a separate management network. This can increase security by ensuring no proxy traffic can reach the appliance on management interface.</p> <p>When you use M1 for management traffic only, you must configure at least one data interface for proxy traffic. Also, you must define different routes for management and data traffic.</p>

Table 4-4 Network Interfaces and Wiring Options in System Setup Wizard (Continued)

Option	Description
Data	<p>Enter the IP address, network mask, and hostname to use for data traffic.</p> <p>If you configure the M1 interface for management traffic only, you must configure the P1 interface for data traffic. However, you can configure the P1 interface even when the M1 interface is used for both management and data traffic.</p> <p>You can use the Data interface for Web Proxy monitoring and optional L4 traffic monitoring. You can also configure this interface to support outbound services, such as DNS, software upgrades, NTP, and traceroute data traffic.</p> <p>Note: You can only enable and configure the P1 network interface for data traffic in the System Setup Wizard. If you want to enable the P2 interface, you must use the <code>ifconfig</code> command after finishing the System Setup Wizard. For more information about configuring the P2 interface, see “Configuring Network Interfaces” on page 485.</p>
L4 Traffic Monitor	<p>Choose the type of wired connections plugged into the “T” interfaces:</p> <ul style="list-style-type: none"> • Duplex TAP. Choose Duplex TAP when the T1 port receives both incoming and outgoing traffic. You can use half- or full-duplex Ethernet connections. • Simplex TAP. Choose Simplex TAP when you connect the T1 port to the internal network (traffic flows from the clients to the Internet) and you connect the T2 port to the external network (traffic flows from the Internet to the clients). <p>IronPort recommends using Simplex when possible because it can increase performance and security.</p>

8. Click **Next**.

The Routes for Management and Data Traffic page appears.

Figure 4-5 System Setup Wizard — Network Tab, Routes for Traffic Page

1. Start	2. Network	3. Security	4. Review
----------	-------------------	-------------	-----------

Routes for Management Traffic (Interface M1: 192.168.1.115)

Default Gateway:

Static Routes Table for Management: 192.168.1.115

Optionally, add static routes for Management access to the IronPort Web Security Appliance.

Name	Destination Network	Gateway	
<input type="text"/>	<input type="text"/>	<input type="text"/>	🗑
<small>Identifying name for route</small>	<small>IP Address (such as 10.1.1.10) or CIDR (such as 10.1.1.0/24)</small>	<small>IP Address</small>	

[Add Route](#)

Routes for Data Traffic (Interface P1: 192.168.2.115)

Default Gateway:

Static Routes Table for Data: 192.168.2.115

Optionally, add static routes for Data traffic. Depending on the appliance functions you enable, these routes will be used for monitoring by the Secure Web Proxy and optional blocking by the L4 Traffic Monitor.

Name	Destination Network	Gateway	
<input type="text"/>	<input type="text"/>	<input type="text"/>	🗑
<small>Identifying name for route</small>	<small>IP Address (such as 10.1.1.10) or CIDR (such as 10.1.1.0/24)</small>	<small>IP Address</small>	

[Add Route](#)

[< Prev](#) [Cancel](#)
[Next >](#)

9. Configure the Routes for Management and Data Traffic options.

The number of sections on this page depend on how you configured the “Use M1 port for management only” check box on the previous wizard page:

- **Enabled.** When you use the Management interface for management traffic only, then this page includes two sections to enter gateway and static route table information, one for management traffic and one for data traffic.
- **Disabled.** When you use the Management interface for both management and data traffic only, then this page includes one section to enter gateway and static route table information. AsyncOS uses the route information for both management and data traffic.

Table 4-5 describes the Routes for Management and Data Traffic options.

Table 4-5 Routes for Management and Data Traffic Options in System Setup Wizard

Option	Description
Default Gateway	Enter the default gateway IP address to use for the traffic through the Management and/or Data interface.

Table 4-5 Routes for Management and Data Traffic Options in System Setup Wizard (Continued)

Option	Description
Static Routes Table	<p>Optionally, you can add one or more static routes for management or data traffic.</p> <p>To add a static route, enter a name for the route, its destination network, and gateway IP address, and then click Add Route. A route gateway must reside on the same subnet as the Management or Data interface on which it is configured.</p> <p>To delete a static route you entered, click the Delete button next to the static route entry in the table.</p> <p>For more information about static routes, see “Configuring TCP/IP Traffic Routes” on page 489.</p>

10. Click **Next**.

The Transparent Connection Settings page appears. By default, when you run the System Setup Wizard, the Web Proxy is deployed in transparent mode. When the Web Proxy is deployed in transparent mode, you must connect it to a Layer 4 switch or a version 2 WCCP router.

Figure 4-6 System Setup Wizard — Network Tab, Transparent Connection Settings Page

1. Start
2. Network
3. Security
4. Review

Transparent Connection Settings

For the IronPort Web Security Appliance to accept transparent connections, it must be connected via a Layer 4 switch or WCCP router.

Transparent Redirection Device:

- Layer 4 Switch or No Device**
If no transparent redirection device is connected, only explicit forward requests can be proxied.
- WCCP v2 Router**
 - Enable standard service ID: 0 web_cache (port 80)
 - Router Addresses:
Separate multiple addresses with commas or whitespace.
 - Enable router security for this service
 - Password:
 - Confirm Password:

Additional WCCP services and advanced options can be configured after completing the System Setup Wizard.

< Prev
Cancel
Next >

11. Choose one of the following options described in Table 4-6.

Table 4-6 Transparent Connection Options in System Setup Wizard

Option	Description
Layer 4 Switch or No Device	Choose this option when the Web Security appliance is connected to a layer 4 switch or if you will deploy the Web Proxy in explicit forward mode after running the System Setup Wizard.
WCCP v2 Router	<p>Choose this option when the Web Security appliance is connected to a version 2 WCCP capable router.</p> <p>If you connect the appliance to a version 2 WCCP router, you must create at least one WCCP service. You can enable the standard service (also known as the “web-cache” service) during system setup, and you can configure different or additional WCCP service groups after you run the System Setup Wizard.</p> <p>When you enable the standard service, choose whether or not to require a password for the standard service group. If required, enter the password in the password fields. The password can contain up to seven characters.</p> <p>For more information about creating WCCP services, see “Adding and Editing a WCCP Service” on page 498.</p>

12. Click **Next**.

The Administrative Settings page appears.

Figure 4-7 System Setup Wizard — Network Tab, Administrative Settings Page

1. Start	2. Network	3. Security	4. Review
----------	-------------------	-------------	-----------

Administrative Settings

Administrator Password: Password: Must be 6 or more characters
 Confirm Password:

Email system alerts to:
e.g. admin@company.com

Send Email via SMTP Relay Host (optional):
i.e., smtp.example.com, 10.0.0.3 Port: optional

AutoSupport: Send system alerts and weekly status reports to IronPort Customer Support

SenderBase Network Participation

Network Participation: Allow IronPort to gather anonymous statistics on HTTP requests and report them to IronPort in order to identify and stop web-based threats.

Participation Level: Limited - Summary URL information.
 Standard - Full URL information. (Recommended)
[Learn what information is shared...](#)

13. Configure the Administrative Settings options.

Table 4-7 describes the Administrative Settings.

Table 4-7 Administrative Settings in System Setup Wizard

Option	Description
Administrator Password	Enter a password to access the Web Security appliance. The password must be six characters or more.
Email System Alerts To	Enter an email address for the account to which the appliance sends alerts. For more information about alerts, see “Managing Alerts” on page 525.
Send Email via SMTP Relay Host	You can enter a host name or address for an SMTP relay host that AsyncOS uses for sending system generated email messages. Optionally, you can enter the port number, too. If no port number is defined, AsyncOS uses port 25. If no SMTP relay host is defined, AsyncOS uses the mail servers listed in the MX record. For more information about configuring the SMTP relay hosts, see “Configuring SMTP Relay Hosts” on page 502.
AutoSupport	Choose whether or not the appliance sends system alerts and weekly status report to IronPort Customer Support.
SenderBase Network Participation	Choose whether or not to participate in the SenderBase Network. If you participate, you can configure limited or full participation. The SenderBase Network is a threat management database that tracks millions of domains around the world and maintains a global watch list for Internet traffic. When you enable SenderBase Network Participation, the Web Security appliance sends anonymous statistics about HTTP requests to IronPort to increase the value of SenderBase Network data. For more information about the SenderBase Network, see “The SenderBase Network” on page 18.

14. Click **Next**.

The Security tab appears.

Step 3. Security

On the Security tab, you can configure which security services to enable, such as whether to block or monitor certain components. The Security tab contains one page.

1. Verify that you are viewing the Security tab.

Figure 4-8 System Setup Wizard — Security Tab

1. Start	2. Network	3. Security	4. Review
----------	------------	--------------------	-----------

Security Settings	
L4 Traffic Monitor:	Action for Suspect Malware Addresses: <input checked="" type="radio"/> Monitor only <input type="radio"/> Block
Acceptable Use Controls: ?	<input checked="" type="checkbox"/> Enable <i>The Global Access Policy will be initially configured to monitor all pre-defined categories.</i> Acceptable Use Controls Service: <input type="radio"/> IronPort URL Filters <input checked="" type="radio"/> Cisco IronPort Web Usage Controls
Web Reputation Filters:	<input checked="" type="checkbox"/> Enable <i>The Global Access Policy will be initially configured to use Web Reputation Filtering.</i>
Malware and Spyware Scanning:	<input checked="" type="checkbox"/> Enable Webroot <input checked="" type="checkbox"/> Enable McAfee <i>The Global Access Policy will be initially configured to apply the actions configured below.</i> Action for Detected Malware: <input checked="" type="radio"/> Monitor only <input type="radio"/> Block
IronPort Data Security Filtering:	<input checked="" type="checkbox"/> Enable <i>The Global IronPort Data Security Policy will be initially configured to block uploads based on Web Reputation (if enabled) and monitor all other uploads.</i>

2. Choose the Security Services options.

Table 4-8 describes the Security options.

Table 4-8 Security Options in System Setup Wizard

Option	Description
L4 Traffic Monitor	<p>Choose whether the Layer-4 Traffic Monitor should monitor or block layer 4 traffic.</p> <p>The L4 Traffic Monitor detects rogue traffic across all network ports and stops malware attempts to bypass port 80.</p> <p>You might choose to monitor traffic when you evaluate the Web Security appliance, and block traffic when you purchase and use the appliance.</p> <p>For more information, see “Configuring the L4 Traffic Monitor” on page 409.</p>
Acceptable Use Controls	<p>Choose whether or not to enable Acceptable Use Controls so you can choose a URL filtering engine, either Cisco IronPort Web Usage Controls or IronPort URL Filters.</p> <p>URL filtering engines allow you to control user access based on the category of a URL in a request. Enable this option when you want to restrict users from accessing particular types of websites.</p> <p>Note: If you enable Cisco IronPort Web Usage Controls, the Dynamic Content Analysis engine is enabled by default. You can edit this setting after system setup.</p> <p>For more information, see “URL Filters” on page 287.</p>

Table 4-8 Security Options in System Setup Wizard (Continued)

Option	Description
Web Reputation Filters	<p>Choose whether or not to enable Web Reputation filtering for the Global Policy Group. When you create custom Access Policy groups, you can choose whether or not to enable Web Reputation filtering.</p> <p>IronPort Web Reputation Filters is a security feature that analyzes web server behavior and assigns a reputation score to a URL to determine the likelihood that it contains URL-based malware.</p> <p>Enable this option when you want to identify suspicious activity and stop malware attacks before they occur.</p> <p>For more information, see “Web Reputation Filters” on page 329.</p>
Malware and Spyware Scanning	<p>Choose whether or not to enable malware and spyware scanning using Webroot or McAfee. If enabled, also choose whether to monitor or block detected malware.</p> <p>You might choose to monitor malware when you evaluate the Web Security appliance, and block malware when you purchase and use the appliance.</p> <p>You can further configure malware scanning after you finish the System Setup Wizard. For details, see “Configuring Anti-Malware Scanning” on page 348.</p>
IronPort Data Security Filtering	<p>Choose whether or not to enable IronPort Data Security Filters. The IronPort Data Security Filters evaluate data leaving the network over HTTP, HTTPS, and FTP to control what data goes where and how and by whom.</p> <p>Enable this option when you want to create IronPort Data Security Policies to block particular types of upload requests.</p> <p>For more information, see “Data Security and External DLP Policies Overview” on page 234.</p>

3. Click **Next**.

The Review tab appears.

Step 4. Review

The last tab of the System Setup Wizard displays a summary of the configuration information you chose. You can edit any of the configuration options by clicking the **Edit** button for each section.

1. Verify that you are viewing the Review tab.

Figure 4-9 System Setup Wizard — Review Tab

1. Start	2. Network	3. Security	4. Review
----------	------------	-------------	------------------

Review Your Configuration

Please review your configuration. If you need to make changes, click the Previous button to return to the previous page. Printable Page

Network Settings Edit	
Default System Hostname:	wsa01.qa
DNS Servers:	192.168.1.10
Network Time Protocol (NTP):	time.ironport.com
Time Zone:	Etc/GMT
Network Context	
Upstream proxy:	No upstream proxy
Interfaces Edit	
Management (M1)	
IP Address:	192.168.1.115
Network Mask:	255.255.255.0
Hostname:	wsa01.qa
Use M1 port for management only:	Yes
Data (P1)	
IP Address:	192.168.2.115
Network Mask:	255.255.255.0
Hostname:	wsa01-p1.qa
L4 Traffic Monitor:	
Wiring Type:	Duplex TAP: T1 (In/Out)
Routes Edit	
Management (M1)	
Default Gateway:	192.168.1.1
Static Routes:	No static routes have been defined.
Data (P1)	
Default Gateway:	192.168.2.1
Static Routes:	No static routes have been defined.
Transparent Connection Settings Edit	
Transparent Redirection Device Type:	Layer 4 Switch or No Device
Administrative Settings Edit	
Administrator Password:	(hidden)
Email System Alerts To:	admin@example.com
Internal SMTP Relay Hosts:	No internal relay host is defined
AutoSupport:	Yes
SenderBase Network Participation:	Yes

Security Settings Edit	
L4 Traffic Monitor:	Monitoring
Acceptable Use Controls:	Enabled Active Acceptable Use Controls Engine: Cisco IronPort Web Usage Controls
Web Reputation Filters:	Enabled
IronPort DVS™ Engine:	Webroot: Enabled McAfee: Enabled
Ironport Data Security Filtering:	Enabled

← Previous
Cancel
Install This Configuration

2. Review the configuration information. If you need to change an option, click the **Edit** button for that section.
3. Click **Install This Configuration** after you confirm the configuration is correct.
The Web Security appliance applies the configuration options you selected.

If you changed the Management interface IP address from the current value, then clicking **Install This Configuration** will cause the connection to the current URL to be lost. However, your browser will redirect itself to the new IP address. If you did not change the IP address from the current value, the System Administration > System Setup > Next Steps page appears.

System Setup Next Steps

Welcome to your IronPort appliance! System setup is complete. Your IronPort appliance should now be configured to work within your network infrastructure. See below for additional tasks and information.

Access Policies

Use Web Security Manager to set up access policies.
[Configure Access Policies](#)

Enter Feature Keys

You enabled several features during System Setup. In order to continue to enjoy these features beyond the initial trial period, you must enter valid feature keys.
[Enter Feature Keys](#)

Reports

The IronPort appliance generates, delivers, and archives periodic reports on web security for your organization.
[Schedule Reports](#)

Send Configuration File

Click the link below to send a copy of the current configuration file to admin@example.com. This file can be used to restore your initial System Setup Wizard defaults if necessary.
[Send Configuration File](#)

FIPS Management

This chapter contains the following topics:

- “FIPS Management Overview” on page 68
- “Understanding How FIPS Management Works” on page 69
- “Managing Certificates and Keys” on page 74
- “Backing up and Restoring Certificates and Keys” on page 79
- “Using the fipsconfig CLI Command” on page 81
- “Working with Multiple HSM Cards” on page 83

FIPS MANAGEMENT OVERVIEW

Some organizations require stricter standards for protecting sensitive, but unclassified, data. The Federal Information Processing Standards (FIPS) 140 is a publicly announced standard developed jointly by the United States and Canadian federal governments specifying requirements for cryptographic modules that are used by all government agencies to protect sensitive but unclassified information. The Cisco IronPort S670 Web Security appliance is offered with a Hardware Security Module (HSM) card that is FIPS 140-2 level 2 certified. The HSM card is a type of secure cryptoprocessor targeted at managing digital keys for server applications.

When the Cisco IronPort S670 Web Security appliance includes the HSM card and uses AsyncOS for Web 6.5, it offloads cryptographic operations to the HSM card in a FIPS compliant manner. The HSM card is responsible for the storage and protection of the cryptographic keys.

FIPS compliance is achieved by use of the CAVIUM Nitrox XL NFBE (HSM), FIPS certificate #1360.

UNDERSTANDING HOW FIPS MANAGEMENT WORKS

FIPS-compliant versions of AsyncOS for Web only run on hardware models that include an HSM card. The HSM card works by performing all cryptographic operations and storing and protecting all cryptographic keys. The HSM card only stores keys, not the corresponding certificates. Certificates are stored on the Web Security appliance hard drive.

The HSM card stores keys for the following components:

- **SSH.** This applies to SSH sessions to the Web Security appliance management interface for administering the appliance using the CLI. The certificate and key pair is automatically generated when you initialize the HSM card.
- **Web interface.** This applies to HTTPS sessions to the Web Security appliance management interface for administering the appliance using the web interface. You can upload a certificate and key pair using the `fipsconfig > certconfig` CLI command.

Note — To connect to the web interface for managing the appliance, you must use HTTPS. HTTP access to the web interface is not supported.

- **HTTPS Proxy.** This applies to HTTPS transactions clients make to HTTPS web servers when the HTTPS Proxy decrypts the transaction to act as the “man in the middle.” You can upload or generate a certificate and key pair in the web interface. If you have multiple FIPS-compliant Web Security appliances that will decrypt HTTPS transactions, you might want to clone the master key on the HSM card of each appliance. For more information, see “Working with Multiple HSM Cards” on page 83.
- **Secure authentication.** This applies to HTTPS transactions between the Web Proxy and clients used for transmitting client authentication credentials. For example, this occurs when you enable credential encryption. You can upload a certificate and key pair in the web interface.

Note — The only SSL version that AsyncOS for Web 6.5 supports is TLS version 1.

Someone within your organization should be designated as the FIPS Officer. The FIPS Officer is responsible for managing the certificate and keys on the HSM card. For more information, see “Working with the FIPS Officer Password” on page 72.

AsyncOS for Web provides a FIPS management console where the FIPS Officer manages all certificates and keys on the HSM card. Access the FIPS management console from the FIPS Mode > FIPS Management page. For more information, see “Logging into the FIPS Management Console” on page 71.

Because all certificate and key pairs are managed in the FIPS management console, you cannot upload or generate certificate and key pairs elsewhere in the web interface. For example, to enable the HTTPS Proxy, you must first upload or generate a certificate and key pair in the FIPS management console and then go to the Security Services > HTTPS Proxy page to enable the HTTPS Proxy. You cannot upload or generate a certificate and key pair on the Security Services > HTTPS Proxy page.

Initializing the HSM Card

If you need to erase the keys stored on the HSM card, you can initialize the HSM card. Initializing the HSM card performs the following functions:

- Resets the FIPS Officer password to the default value.
- Erases all existing keys stored on the HSM card and erases all corresponding certificates stored on the appliance hard drive.
- Disables the HTTPS Proxy and credential encryption.
- Sends an email alert to the Web Security appliance administrator users to report the initialization.
- Generates a new certificate and key pair for accessing the appliance using SSH and HTTPS. The certificate is stored on the appliance hard drive and the key is stored on the HSM card.

To initialize the HSM card, run the `fipsconfig > init` CLI command. Three failed login attempts in a row also initializes the HSM card.

When you first receive a FIPS-compliant Web Security appliance, the HSM card is in an initialized state. This means the HSM card contains a certificate and key pair to allow SSH transactions to the appliance. It also contains the “IronPort Appliance Demo Certificate” and corresponding private key that allows access to the web interface using HTTPS and securely transmitting authentication credentials with clients using credential encryption. It does not contain a certificate and key pair to allow HTTPS decryption. All corresponding keys are stored on the HSM card. However, client applications are not programmed to recognize these certificates, so you can upload a digital certificate to the appliance that your applications recognize automatically.

When the HSM card is initialized and depending on the organization’s needs, the FIPS Officer may upload different certificates and keys by performing any of the following steps:

- Log into the appliance using the CLI and upload a different certificate and key pair to allow HTTPS access to the web interface. Do this using the `fipsconfig > certconfig` CLI command. For more information, see “Using the `fipsconfig` CLI Command” on page 81.
- Log into the web interface using HTTPS and upload or generate certificate and key pairs for HTTPS Proxy and secure authentication. Do this on the FIPS Mode > FIPS Management page. For more information, see “Managing Certificates and Keys” on page 74.

Note — Some SSH clients and web browsers automatically lose the SSH or HTTPS connection when the HSM initializes or when the wrong password is entered three times. In this case, the administrator must manually reboot the appliance by powering it off and on.

Logging into the FIPS Management Console

After you log into the Web Security appliance as an administrator user, you can log into the FIPS management console to manage the HSM card. You can log into and out of the FIPS management console separately while remaining logged into the rest of the appliance web interface.

Access the FIPS management console from the FIPS Mode menu in the upper right corner of the web interface. Figure 5-1 shows the FIPS Mode menu.

Figure 5-1 FIPS Mode Menu

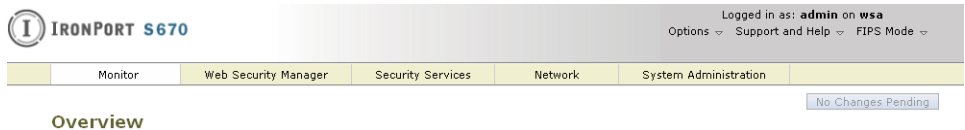

Logging out of the FIPS management console does not affect the session logged into the appliance as the administrator user. However, if you log out of the web interface without manually logging out of the FIPS management console, AsyncOS for Web automatically logs you out of the FIPS management console.

The default FIPS Officer password is `sopin123`.

WARNING: AsyncOS for Web keeps track of the total number of failed login attempts to the HSM card using the FIPS Officer password. On the third login failure, the HSM card is initialized, which clears its contents. There is no timeout between failed login attempts. Because the HSM card gets initialized, it loses the certificate and key for accessing the appliance web interface. If the HSM card initializes after the third unsuccessful login attempt, the browser displays a generic error message that it cannot display the webpage. For more information, see “Initializing the HSM Card” on page 70.

Note — Cisco recommends that you do not use the web browser’s Back button to navigate back toward the FIPS management console login page. If you enter the incorrect FIPS Officer password, navigate away from the page, and use the browser’s Back button to return to the FIPS management console, the browser submits the incorrect password again, causing you to fail the login twice.

To log into the FIPS Management console:

1. From the FIPS Mode menu, choose FIPS Login.

Figure 5-2 shows the FIPS Login page.

Figure 5-2 FIPS Login Page

FIPS Login

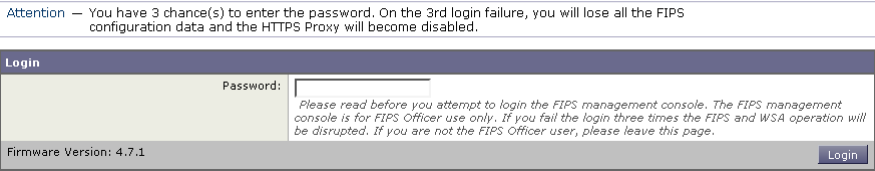

2. Enter the FIPS Officer password and click **Login**.

The FIPS management console appears.

Figure 5-3 shows the FIPS management console on the FIPS Management page.

Figure 5-3 FIPS Management Console

FIPS Management

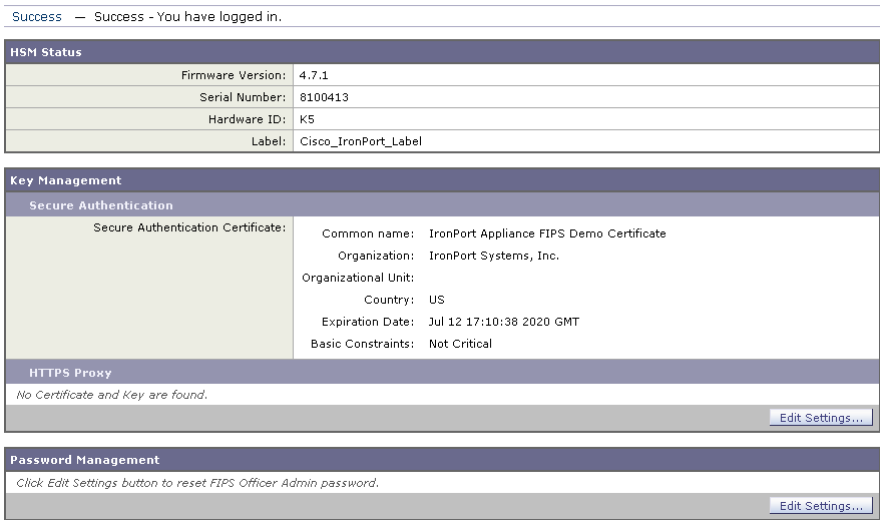

3. If this is the first time accessing the FIPS management console, change the FIPS Officer password by clicking **Edit Settings** in the Password Management section. For more information, see “Working with the FIPS Officer Password” on page 72.

Working with the FIPS Officer Password

To manage certificate and key pairs on the HSM card, you must log into the Web Security appliance as an administrator and then provide the FIPS Officer password. You need the FIPS Officer password to access the FIPS management console or to use the `fipsconfig` CLI command.

Note — There is no way to retrieve the FIPS Officer password once it is set. If you forget the FIPS Officer password, the only way to access the HSM card is to initialize it, which wipes all certificates and keys it manages. Cisco recommends backing up all data on the HSM card after it is fully configured. For more information, see “Backing up and Restoring Certificates and Keys” on page 79.

After you log into the FIPS management console, you can change the FIPS Officer password.

To change the FIPS Officer password:

1. Log into the FIPS management console.
2. Click **Edit Settings** in the Password Management section.

Figure 5-4 shows the Edit Password Management Settings page.

Figure 5-4 Edit Password Management Settings Page

Edit Password Management Settings

FIPS Officer Admin Password	
<i>The FIPS Officer Admin Password is used by a FIPS officer user to login the FIPS management console.</i>	
Current Password:	<input type="password"/>
New Password:	<input type="password"/>
	<i>The password must be 7-16 characters long</i>
Re-Type Password:	<input type="password"/>

3. Enter the current FIPS Officer password and the new FIPS Officer password in the appropriate fields.
4. Click **Submit**.

Supported Certificate Types

When an SSL session uses an RSA key, the key is protected by the HSM card. When an SSL session uses a DSA key, the key is not protected by the HSM card. The web interface and CLI prevent administrators from uploading certificates that use DSA keys.

Logging

For error messages related to FIPS management, read the Proxy Error Logs at the trace or debug level. You can search for “HSM” in Proxy Error Logs to get HSM related information.

MANAGING CERTIFICATES AND KEYS

You can use the HSM card to manage certificates and keys used by the Web Security appliance. To do this, log into the FIPS management console, and click **Edit Settings** in the Key Management section. Figure 5-5 shows the Edit Key Management Settings page.

Figure 5-5 Edit Key Management Settings Page

Edit Key Management Settings

Key Management Settings

Secure Authentication Certificate and Key

Secure Authentication Certificate:

Common name: IronPort Appliance FIPS Demo Certificate
 Organization: IronPort Systems, Inc.
 Organizational Unit:
 Country: US
 Expiration Date: Jun 18 00:26:38 2020 GMT
 Basic Constraints: Not Critical

Certificate:

Key:
Private key must be unencrypted.

Uploading a new pair of certificate and key will replace the currently used certificate and key as displayed above.

HTTPS Proxy Certificate and Key

Root Certificate for Signing:

Use Generated Certificate and Key

No certificate has been generated.

Use Uploaded Certificate and Key

Certificate:

Key:
Private key must be unencrypted.

No certificate has been uploaded.

Backup Certificates and Keys

Backup Certificate and Keys to Local Computer:

Use system-generated file name

Use user-defined file name:

Note: ".xml" will be appended to the specified file-name automatically.

Restore Certificates and Keys

Restore Certificates and Keys:

Load certificate and key from local computer:

Include HTTPS Proxy Certificate and Key
 Include Secure Authentication Certificate and Key
 Include Secure Web UI Certificate and Key

On the Edit Key Management Settings page, you can perform the following tasks:

- **Upload certificate and key for secure authentication.** For more information, see “Uploading a Certificate and Key for Secure Authentication” on page 75.
- **Upload certificate and key for the HTTPS Proxy.** For more information, see “Uploading and Generating a Certificate and Key for the HTTPS Proxy” on page 76.
- **Backup and restore certificates and keys the HSM card manages.** For more information, see “Backing up and Restoring Certificates and Keys” on page 79.

Uploading a Certificate and Key for Secure Authentication

When credential encryption is enabled, the appliance uses a digital certificate to securely establish a connection with the client application. Then, using the secure HTTPS connection, the clients send the authentication credentials to the Web Proxy for authentication. To configure the appliance to use credential encryption, enable the Credential Encryption setting in the global authentication settings. For more information, see “Sending Authentication Credentials Securely” on page 383.

By default, the appliance uses the “IronPort Appliance Demo Certificate” and a corresponding private key that is stored on the HSM card. However, you can choose to upload a different certificate that the client applications on the network recognize along with a private key that is stored on the HSM card. The appliance then uses this certificate and key pair to establish the HTTPS session with clients.

To upload a certificate and key to use for securely communicating authentication:

1. Log into the FIPS management console.
2. Click **Edit Settings** in the Key Management section.
3. View the Secure Authentication Certificate and Key section on the Edit Key Management Settings page.

Figure 5-6 shows the Secure Authentication Certificate and Key section.

Figure 5-6 Secure Authentication Certificate and Key Section

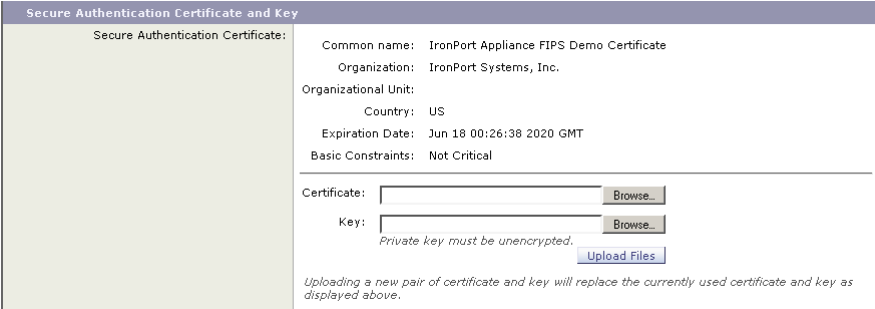

Secure Authentication Certificate and Key	
Secure Authentication Certificate:	Common name: IronPort Appliance FIPS Demo Certificate Organization: IronPort Systems, Inc. Organizational Unit: Country: US Expiration Date: Jun 18 00:26:38 2020 GMT Basic Constraints: Not Critical
Certificate:	<input type="text"/> <input type="button" value="Browse..."/>
Key:	<input type="text"/> <input type="button" value="Browse..."/>
	<i>Private key must be unencrypted.</i> <input type="button" value="Upload Files"/>
<i>Uploading a new pair of certificate and key will replace the currently used certificate and key as displayed above.</i>	

4. To upload a certificate, click **Browse** for the Certificate field and navigate to the certificate file on your local machine.
5. To upload a key, click **Browse** for the Key field and navigate to the key file on your local machine.
6. Click **Upload Files** after you select the files you want.
7. Submit your changes.

Uploading and Generating a Certificate and Key for the HTTPS Proxy

To monitor and decrypt HTTPS traffic, you must enable the HTTPS Proxy on the Security Services > HTTPS Proxy page. When you enable the HTTPS Proxy, you must configure what the appliance uses for a root certificate when it sends self-signed server certificates to the client applications on the network. You can upload a root certificate and key that your organization already has, or you can configure the appliance to generate a certificate and key with information you enter. However, to enable the HTTPS Proxy on a FIPS-compliant Web Security appliance, you must first use the FIPS management console to upload or generate a root certificate and key. After the certificate and key pair is uploaded or generated, then you can enable the HTTPS Proxy.

For more information, see “Enabling the HTTPS Proxy” on page 217.

To upload a certificate and key for the HTTPS Proxy:

1. Log into the FIPS management console.
2. Click **Edit Settings** in the Key Management section.
3. Scroll down to the HTTPS Proxy Certificate and Key section on the Edit Key Management Settings page.

Figure 5-7 shows the HTTPS Proxy Certificate and Key section.

Figure 5-7 HTTPS Proxy Certificate and Key Section

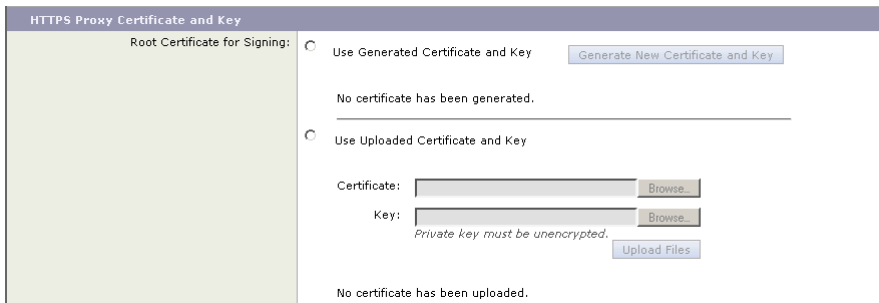

4. Choose which root certificate to use for signing self-signed certificates the appliance sends to clients:
 - **Generated certificate and key.** Go to step 5 on page 77.

- **Uploaded certificate and key.** Go to step 6 on page 77.

For more information about how the appliance uses these root certificates, see “Working with Root Certificates” on page 213.

Note — If the appliance has both an uploaded certificate and key pair and a generated certificate and key pair, it only uses the certificate and key pair currently selected in the Root Certificate for Signing section.

- To generate a certificate and key:
 - Select the Use Generated Certificate and Key option.
 - Click **Generate New Certificate and Key**.

- In the Generate Certificate and Key dialog box, enter the information to display in the root certificate.

Note — You can enter any ASCII character except the forward slash (/) in the Common Name field.

- Click **Generate**. The Web Security appliance generates the certificate with the data you entered and generates a key.

The generated certificate information is displayed on the Edit Key Management Settings page.

- Go to step 7 on page 78.

- To upload a root certificate and key:
 - Select Use Uploaded Certificate and Key.
 - Click **Browse** for the Certificate field to navigate to the certificate file stored on the local machine.

If the file you upload contains multiple certificates or keys, the Web Proxy uses the first certificate or key in the file.

Note — The certificate file must be in PEM format. DER format is not supported.

- c. Click **Browse** for the Key field to navigate to the private key file. The private key must be unencrypted.

Note — The key length must be 1024 or 2048 bits. Also, the private key file must be in PEM format. DER format is not supported.

- d. Click **Upload Files**.

The uploaded certificate information is displayed on the Edit Key Management Settings page.

7. Submit your changes.

BACKING UP AND RESTORING CERTIFICATES AND KEYS

You can back up the certificates and keys the HSM card manages to an XML file. Similarly, you can restore the certificates and keys from the XML file to the HSM card. Backing up includes all certificates and keys stored in the HSM card in the XML file. The keys are encrypted before being stored to the file. When you restore from the XML file, you can choose which certificate and key pairs to restore.

Note — When you save the appliance configuration to a file, the certificate and keys the HSM card manages are not included in the configuration file. Also, if you restore the appliance configuration from a file that erroneously includes certificate and key information, AsyncOS ignores the certificate and key information in the file.

To back up and restore certificates and keys, use the Backup Certificates and Keys section on the Edit Key Management Settings page. Figure 5-8 shows where you back up and restore certificates and keys on the Edit Key Management Settings page.

Figure 5-8 Backing up and Restoring Certificates and Keys

The image shows two screenshots of the AsyncOS interface. The top screenshot is titled "Backup Certificates and Keys" and contains the following elements: a header "Backup Certificates and Keys to Local Computer:", two radio button options: "Use system-generated file name" (selected) and "Use user-defined file name:" (with an empty text input field), and a note: "Note: '.xml' will be appended to the specified file-name automatically." A "Backup" button is located at the bottom right. The bottom screenshot is titled "Restore Certificates and Keys" and contains the following elements: a header "Restore Certificates and Keys:", a section "Load certificate and key from local computer:" with a text input field and a "Browse..." button, and three checkboxes: "Include HTTPS Proxy Certificate and Key", "Include Secure Authentication Certificate and Key", and "Include Secure Web UI Certificate and Key". A "Restore" button is located at the bottom right.

Backing up Certificates and Keys

To back up the certificates and keys the HSM card manages:

1. From the FIPS management console, click **Edit Settings** in the Key Management section.
The Edit Key Management Settings page displays.
2. Scroll down to the Backup Certificates and Keys section, and choose the file name to use for the XML file that will contain the encrypted certificate and key pairs. You can define your own file name or AsyncOS for Web can choose one for you.
3. Click **Backup**.
4. Choose to save the file, and click OK.
5. Navigate to the directory on the local machine to where you want to save the XML file, and click **Save**.

Restoring Certificates and Keys

When you back up the certificates and keys the HSM card manages, the keys are encrypted. Because the keys are encrypted, they can only be restored on a different FIPS-compliant Web Security appliance if the master key on the other appliance is the same as the one from which the certificates and keys were backed up. Note that when the HSM card gets initialized, its master key changes. For more information on copying the master key between appliances, see “Working with Multiple HSM Cards” on page 83.

To restore a certificate and key pair stored in an XML file:

1. From the FIPS management console, click **Edit Settings** in the Key Management section.
The Edit Key Management Settings page displays.
2. Scroll down to the Restore Certificates and Keys section, and click **Browse**.
3. Navigate to the directory on the local machine where the XML file resides, and click **Open**.
4. Click the check boxes for the certificate and key pairs you want to restore.
5. Click **Restore**.

USING THE FIPSCONFIG CLI COMMAND

AsyncOS for Web includes the `fipsconfig` CLI command to perform the following tasks:

- Initialize the HSM card.
- Read the HSM card status.
- Configure the certificate and key to access the appliance web interface.
- Configure multiple HSM cards to use the same master key.

When you enter `fipsconfig` at the command line, the CLI prompts you to enter the FIPS Officer password. For more information, see “Working with the FIPS Officer Password” on page 72.

Table 5-1 describes the `fipsconfig` subcommands.

Table 5-1 `fipsconfig` Subcommands

<code>fipsconfig</code> Subcommand	Description
<code>init</code>	Initializes the card and reboots the Web Security appliance. For more information, see “Initializing the HSM Card” on page 70. Note: Some SSH clients automatically lose the SSH connection when the HSM initializes or when the wrong password is entered 3 times. In this case, the administrator must manually reboot the appliance by powering off and on.
<code>getinfo</code>	Displays the HSM card status.
<code>certconfig</code>	Allows you to configure the security certificate and key to access the Web Security appliance web interface using HTTPS. This command works similarly to the <code>certconfig</code> CLI command. For more information on using <code>certconfig</code> , see “Uploading Certificates to the Web Security Appliance” on page 535. For more information about the requirements involved with uploading a certificate for web interface access, see “Installing a Server Digital Certificate” on page 534. Note: The certificate you upload must be a server certificate, not a root certificate.
<code>clonetarget</code>	Clones the HSM card as a target when copying the master key among multiple HSM cards. For more information, see “Working with Multiple HSM Cards” on page 83.

Table 5-1 fipsconfig Subcommands (Continued)

fipsconfig Subcommand	Description
clonesource	Clones the HSM card as a source when copying the master key among multiple HSM cards. For more information, see “Working with Multiple HSM Cards” on page 83.

WORKING WITH MULTIPLE HSM CARDS

When client HTTPS traffic might be processed by any of several Web Security appliances, the client applications need to be able to recognize the signing certificate used on each Web Security appliance when it mimics HTTPS servers for decrypting traffic. Optionally, you can ensure that each appliance uses the same signing certificate for decrypting HTTPS traffic by uploading the same certificate and key to each appliance.

You can also choose to generate a certificate and key on the FIPS-compliant appliance to use for HTTPS decryption. However, if you want to use that same certificate and key pair on a different FIPS-compliant appliance, you must first clone the master key from one HSM card (the source appliance) to another HSM card (the target appliance). You might want to clone the master key between HSM cards if you want the client applications on the network to recognize only one certificate used for decrypting HTTPS traffic when the certificate and key are generated on a FIPS-compliant appliance.

Note — Cisco recommends you clone the master keys immediately after the HSM card is initialized.

To clone the master key among a source and target HSM card, you need to have access to the following:

- SSH session to the source HSM card machine and another SSH session to the target HSM card machine. Each SSH session needs to remain open during the process. You can run the SSH sessions from the same local machine or different local machines.
- FTP session to the source and target HSM card machines. You must run the FTP sessions from the same local machine so you can copy files between the source and target machines.

To clone the master key between HSM cards:

1. Open an SSH session to the source Web Security appliance and run the `fipsconfig > clonesource` CLI command. This command creates the Token Wrapping Certificate (TWC) file (`twc.file`). The CLI command prompts you to enter the name of the `part1.file` file. Do not enter anything yet. Keep the CLI session open.
2. Use FTP to copy the TWC file from the source appliance in step 1 to the target appliance. The TWC file is located in the FTP root directory.
3. Open an SSH session to the target Web Security appliance and run the `fipsconfig > clonetarget` CLI command. Enter the name of the TWC file (`twc.file` by default) and press Enter. This command generates the `key.file` and `part1.file` using the `twc.file` copied from the source appliance in step 2. The CLI command prompts you to enter the name of the `part2.file` file. Do not enter anything yet. Keep the CLI session open.
4. Use FTP to copy `part1.file` from the target appliance to the source appliance.

5. Return to the CLI session for the source appliance and that has the open CLI command. Enter the name of the part1.file file you copied from the target appliance and press Enter. This generates the part2.file file.
6. Use FTP to copy the part2.file file from the source appliance to the target appliance.
7. Return to the CLI session for the target appliance and that has the open CLI command. Enter the name of the part2.file file you copied from the source appliance and press Enter. This generates a master key on the target appliance that matches the master key on the source appliance.

Web Proxy Services

This chapter contains the following information:

- “About Web Proxy Services” on page 86
- “Configuring the Web Proxy” on page 88
- “Working with FTP Connections” on page 92
- “Bypassing the Web Proxy” on page 98
- “Proxy Usage Agreement” on page 100
- “Configuring Client Applications to Use the Web Proxy” on page 101
- “Working with PAC Files” on page 102
- “Adding PAC Files to the Web Security Appliance” on page 106
- “Advanced Proxy Configuration” on page 108

ABOUT WEB PROXY SERVICES

A web proxy is a computer system or software that handles World Wide Web requests of clients by making requests of other servers on the web. The Web Security appliance can act as a web proxy if you enable the Web Proxy feature.

The Web Proxy service monitors and controls traffic that originates from clients on the internal network. Typically, the Web Proxy-enabled Web Security appliance is deployed between clients and the firewall where it intercepts requests for content from clients to servers.

You can configure the Web Proxy as one of the following types:

- **Transparent Proxy.** When the appliance is configured as a transparent proxy, clients are unaware of the Web Proxy. Client applications, such as web browsers, do not have to be configured to accommodate the appliance. You might want to configure the appliance as a transparent proxy because it eliminates the possibility of users reconfiguring their web browsers to bypass the appliance without knowledge of the administrator. To configure the appliance as a transparent proxy, you must connect it to an L4 switch or a WCCP router.

For information about how to configure the appliance when you configure the proxy in transparent mode, see “Configuring Transparent Redirection” on page 495.

- **Explicit Forward Proxy.** In an explicit forward proxy configuration, the appliance acts on behalf of client web browsers to handle requests for servers on the web. Users must configure their web browsers to point to a single Web Security appliance. You might want to configure the appliance as an explicit forward proxy if you do not have an L4 switch or a WCCP router.

You can use the Web Security appliance in a network that includes another proxy server. For more information about how to deploy and configure the appliance when the network contains another proxy, see “Using the Web Security Appliance in an Existing Proxy Environment” on page 40.

The Web Proxy handles both HTTP and native FTP transactions. For more information about working with FTP, see “Working with FTP Connections” on page 92.

Web Proxy Cache

By default, AsyncOS uses a web proxy cache to increase performance for users accessing the web in some cases.

You can edit the web proxy and proxy cache in the following ways:

- **Remove a URL from the cache.** Use the `evict` subcommand of the `webcache` CLI command to remove one or more URLs from the cache.
- **Specify a domain or URL to never cache.** Use the `ignore` subcommand of the `webcache` CLI command to specify one or more domains or URLs that the web proxy should never

store in the proxy cache. You can include embedded regular expression (regex) characters in the URL you specify to never cache.

Each access log file entry includes transaction result codes that describe how the appliance resolved client requests. Transaction result codes indicate whether the transaction was served from the proxy cache or from the destination server. For more information about transaction result codes, see “Transaction Result Codes” on page 458.

CONFIGURING THE WEB PROXY

Web Proxy settings are configured as part of an initial setup using the System Setup Wizard. To enable Web Proxy services or modify proxy settings after an initial configuration, use the Security Services > Proxy Settings page. This page allows you to configure basic and advanced settings to customize proxy services.

The Web Proxy settings apply to all connections that go over HTTP or HTTPS. To configure proxy settings for native FTP connections, see “Working with FTP Connections” on page 92.

To edit the Web Proxy settings:

1. Navigate to the Security Services > Proxy Settings page.
2. Click **Edit Settings**.

Figure 6-1 Editing Web Proxy Settings

Edit Web Proxy Settings

Web Proxy Settings	
<input checked="" type="checkbox"/> Enable Proxy	
Basic Settings	
HTTP Ports to Proxy:	<input type="text" value="80, 3128"/>
Caching:	<input checked="" type="checkbox"/> Enable
Proxy Mode:	<input checked="" type="radio"/> Transparent <input type="radio"/> Forward <small>When in Transparent mode, the proxy can accept both transparent and explicit forward connections. Transparent connections require a transparent redirection device (see Network > Transparent Redirection). When in Forward mode, only explicit forward connections are supported.</small>
IP Spoofing:	<input type="checkbox"/> Enable IP Spoofing <input checked="" type="radio"/> For Transparent Connections Only <input type="radio"/> For All Connections <small>When enabling IP spoofing, if using a WCCP router, configure a service to redirect the return path (see Network > Transparent Redirection).</small>
Advanced Settings	
Persistent Connection Timeout: (?)	Client Side: <input type="text" value="300"/> seconds Server Side: <input type="text" value="300"/> seconds
In-Use Connection Timeout: (?)	Client Side: <input type="text" value="300"/> seconds Server Side: <input type="text" value="300"/> seconds
Simultaneous Persistent Connections:	Server Maximum Number: <input type="text" value="2000"/>
Headers:	X-Forwarded-For: <input type="radio"/> Send <input checked="" type="radio"/> Do Not Send VIA: <input checked="" type="radio"/> Send <input type="radio"/> Do Not Send

3. Verify the Enable Proxy field is selected.

4. Configure the basic and advanced Web Proxy settings defined in Table 6-1.

Table 6-1 Web Proxy Settings

Property	Description
HTTP Ports to Proxy	Enter which ports the Web Proxy monitors for HTTP requests. Default is 80 and 3128.
Caching	Choose whether or not the Web Proxy should cache requests and responses. Default is enabled.
Proxy Mode	Choose how to deploy the Web Proxy: <ul style="list-style-type: none"> • Transparent mode. Client applications are unaware of the Web Proxy and do not have to be configured to connect to the proxy. In transparent mode, the Web Proxy can accept both transparently redirected and explicitly forwarded connections. For more information, see “Deploying the Web Proxy in Transparent Mode” on page 34. • Explicit forward mode. Client applications, such as web browsers, are aware of the Web Proxy and must be configured to point to a single Web Security appliance. In explicit forward mode, the Web Proxy can only accept explicitly forwarded connections. For more information, see “Deploying the Web Proxy in Explicit Forward Mode” on page 33.
IP Spoofing	Choose whether or not the Web Proxy should spoof IP addresses when sending requests to upstream proxies and servers. When the Web Proxy is deployed in transparent mode, you can enable IP spoofing for transparently redirected connections only or all connections (transparently redirected and explicitly forwarded). When IP spoofing is enabled, requests originating from a client retain the client’s source address and appear to originate from the client rather than from the Web Security appliance. Note: When IP spoofing is enabled and the appliance is connected to a WCCP router, configure a WCCP service to redirect the return path.

Table 6-1 Web Proxy Settings (Continued)

Property	Description
<p>Persistent Connection Timeout</p>	<p>Enter how long the Web Proxy keeps open a connection to a client or server after a transaction has been completed. Keeping a connection open allows the Web Proxy to use it again for another request.</p> <p>For example, after a client finishes a transaction with google.com, the Web Proxy keeps the connection to the server google.com open for the amount of time specified in the server side persistent timeout if no other client makes a request for google.com.</p> <ul style="list-style-type: none"> • Client side. The maximum number of seconds the Web Proxy keeps a connection open with a client on the network with no activity from the client. • Server side. The maximum number of seconds the Web Proxy keeps a connection open with a destination server with no activity from any client on the network to that server. <p>Default is 300 seconds for both client and server side persistent timeouts.</p> <p>You might want to increase the server side persistent timeout if clients on the network frequently connect to the same server, or if the network has a relatively slow connection to outside servers.</p> <p>IronPort recommends keeping the default values. However, you might want to increase or decrease these values to keep connections open longer to reduce overhead used to open and close connections repeatedly. Consider that if you increase the persistent timeout values, you also reduce the ability of the Web Proxy to open new connections if the maximum number of simultaneous persistent connections has been reached.</p>
<p>In-Use Connection Timeout</p>	<p>Enter how long the Web Proxy waits for more data from an idle client or server when the current transaction has not been completed.</p> <p>For example, if a client opens a connection and sends only half of the request, the Web Proxy waits for the amount of time specified for the client side reserve timeout for the rest of the request before closing the open connection.</p> <ul style="list-style-type: none"> • Client side. The maximum number of seconds the Web Proxy keeps a connection open with an idle client. • Server side. The maximum number of seconds the Web Proxy keeps a connection open with an idle destination server. <p>Default is 300 seconds for both client and server side reserve timeouts.</p>
<p>Simultaneous Persistent Connections (Server Maximum Number)</p>	<p>Enter the maximum number of connections (sockets) the Web Proxy keeps open with servers.</p>

Table 6-1 Web Proxy Settings (Continued)

Property	Description
Headers	<ul style="list-style-type: none">• X-Forwarded-For. Choose whether or not to forward HTTP “X-Forwarded-For” headers. Default is Do Not Send. Note: If the network contains an explicit forward upstream proxy that manages user authentication or access control using proxy authentication, you must enable the X-Forwarded-For header to send the client host header to the upstream proxy.• VIA. Choose whether or not to forward HTTP “VIA” headers. Default is Send.

5. Submit and commit your changes.

WORKING WITH FTP CONNECTIONS

The Web Security appliance Web Proxy provides proxy services for the File Transfer Protocol (FTP) as well as HTTP. FTP is a protocol used to transfer data between computers over a network. The Web Proxy can handle the following FTP transactions:

- **FTP over HTTP.** Most web browsers support FTP transactions, but sometimes the transactions are encoded inside an HTTP transaction. All policies and configuration options that apply to HTTP transactions also apply to FTP over HTTP transactions.
- **Native FTP.** FTP clients use FTP to transfer data without invoking an HTTP connection. Native FTP connections are treated and handled differently than HTTP connections.

The component of the Web Proxy that handles native FTP transactions is referred to as the FTP Proxy.

Native FTP connections can be served when the Web Proxy is deployed in either transparent or explicit forward mode.

Computers that transfer data using FTP create two connections between them. The control connection is used to send and receive FTP commands, such as RETR and STOR, and to communicate other information, such as the connection mode and file properties. The data connection is used to transfer the data itself. Typically, computers use port 21 for the control connection, and use a randomly assigned port (usually greater than 1023) for the data connection.

The FTP Proxy supports the following connection modes:

- **Passive.** In passive mode, the FTP server chooses the port used for the data connection and communicates this assignment to the FTP client. Passive mode is typically favored in most network environments where the FTP client is located behind a firewall and inbound connections (such as from an FTP server) are blocked. The default for the FTP Proxy is passive mode.
- **Active.** In active mode, the FTP client chooses the port used for the data connection and communicates this assignment to the FTP server.

Consider the following rules and guidelines when working with native FTP connections:

- You can define which Identity groups apply to native FTP transactions.
- You configure FTP Proxy settings that apply to native FTP connections. For more information, see “Configuring FTP Proxy Settings” on page 94.
- You can configure which welcome message users see in the FTP client when they connect to an FTP server. Configure the welcome banner when you configure the FTP Proxy settings.
- You can define a custom message the FTP Proxy displays in IronPort FTP notification messages when there is an error with FTP Proxy authentication. For more information, see “Working with IronPort FTP Notification Messages” on page 277.

- When the FTP Proxy is configured to cache native FTP transactions, it only caches content accessed by anonymous users.
- You can configure the FTP Proxy to spoof the IP address of the FTP server. You might want to do this when FTP clients do not allow passive data connections when the source IP address of the data connection (FTP server) is different than the source IP address of the control connection (FTP Proxy).
- If the connection between the FTP Proxy and the FTP server is slow, uploading a large file may take a long time when IronPort Data Security Filters are enabled. If the FTP client times out before the FTP Proxy uploads the entire file, users may notice a failed transaction.

Using Authentication with Native FTP

The FTP Proxy performs user authentication to control which users can make native FTP requests. This user authentication determines which policy groups apply to the native FTP transaction.

However, due to the nature of FTP and FTP clients, only explicit forward connections can authenticate users for native FTP transactions. Due to this limitation, you must configure at least one Identity and Access Policy for native FTP transactions that do not require authentication when the Web Proxy is deployed in transparent mode. This allows FTP connections that are transparently redirected to the Web Security appliance to work. If authentication is required for all policy groups, transparently redirected native FTP transaction will fail.

You can configure the authentication format the FTP Proxy uses when communicating with FTP clients. The FTP Proxy supports the following formats for proxy authentication:

- **Check Point.** Uses the following formats:
 - User: ftp_user@proxy_user@remote_host
 - Password: ftp_password@proxy_password
- **Raptor.** Uses the following formats:
 - User: ftp_user@remote_host proxy_user
 - Password: ftp_password
 - Account: proxy_password

When using authentication with native FTP, ensure that the FTP client uses the same authentication settings configured for the FTP Proxy.

Note — Be careful when requiring authentication for native FTP transactions. FTP is inherently insecure because data (including the authentication credentials) is transmitted directly over the wire without encryption.

Working with Native FTP in Transparent Mode

When the Web Security appliance is deployed in transparent mode, FTP clients typically are not explicitly configured to use the FTP Proxy. Native FTP connections are transparently redirected to the FTP Proxy and then processed.

When a native FTP request is transparently redirected to the FTP Proxy, it contains no hostname information for the FTP server, only its IP address. Because of this, the FTP Proxy only matches native FTP transactions with IP addresses configured in the Access Policies.

The predefined URL categories and Web Reputation Filters block by hostname and IP address, but for some servers, they may only have hostname information and not the server's IP address. For example, if the "News" predefined URL category contains the cnn.com, but not the corresponding IP address for that server, and if that URL category is configured to block, then native FTP connections to cnn.com will successfully connect instead of being blocked. Therefore, to make sure the FTP Proxy blocks native FTP connections to certain sites, you must create custom URL categories and enter the IP addresses in the list of sites to block or in the regular expression field.

Configuring FTP Proxy Settings

The FTP Proxy settings apply to native FTP connections. To configure proxy settings that apply to FTP over HTTP connections, configure the Web Proxy. For more information, see "Configuring the Web Proxy" on page 88.

To configure the FTP Proxy settings:

1. Navigate to the Security Services > FTP Proxy Settings page, and click **Edit Settings**.

Figure 6-2 Configuring FTP Proxy Settings

Edit FTP Proxy Settings

FTP Proxy Settings

Enable FTP Proxy ?

Basic Settings

Proxy Listening Port: ? 8021

Caching: Enable

Server Side IP Spoofing: Enable

Authentication Format: Check Point

Passive Mode Data Port Range: ? 11000-11009

Active Mode Data Port Range: ? 12000-12009

Active Mode Failover: ? Enable

Welcome Banner: Use FTP Server message
This option will not be available when the proxy is configured in explicit forward mode.
 Use Custom message

Advanced Settings

Control Connection Timeouts: Client Side: 300 seconds
 Server Side: 300 seconds

Data Connection Timeouts: Client Side: 300 seconds
 Server Side: 300 seconds

2. Verify the Enable FTP Proxy field is selected.
3. Configure the basic and advanced FTP Proxy settings defined in Table 6-2.

Table 6-2 FTP Proxy Settings

Property	Description
Proxy Listening Port	Specify the port FTP clients should use to establish a control connection with the FTP Proxy.
Caching	Choose whether or not to cache contents of data connections from anonymous users.
Server Side IP Spoofing	Choose whether or not the FTP Proxy should spoof the FTP server IP address. You might want to do this for FTP clients that do not allow transactions when the IP address is different for the control and data connections.
Authentication Format	Choose the authentication format the FTP Proxy uses when communicating with FTP clients. For more information, see “Using Authentication with Native FTP” on page 93.

Table 6-2 FTP Proxy Settings (Continued)

Property	Description
Passive Mode Data Port Range	Specify a range of TCP ports FTP clients should use to establish a data connection with the FTP Proxy for passive mode connections. Default is 11000-11009.
Active Mode Data Port Range	Specify a range of TCP ports FTP servers should use to establish a data connection with the FTP Proxy for active mode connections. Default is 12000-12009. You might want to increase the port range in this field to accommodate more requests from the same FTP server. Because of the TCP session TIME-WAIT delay (usually a few minutes), a port does not become available again for the <i>same</i> FTP server immediately after being used. As a result, any given FTP server cannot connect to the FTP Proxy in active mode more than <i>n</i> times in a short period of time, where <i>n</i> is the number of ports specified in this field.
Active Mode Failover	When this option is enabled, the FTP Proxy will attempt an active mode connection with the FTP server when passive mode fails.
Welcome Banner	Choose which welcome message should be displayed in FTP clients: <ul style="list-style-type: none"> • FTP server message. The FTP server message only displays for transparently redirected connections. When a native FTP connection is explicitly sent to the FTP Proxy, the FTP client displays a message predefined by the FTP Proxy. • Custom message. Enter a message to display for all native FTP connections.
Control Connection Timeouts	Enter how long the FTP Proxy waits for more communication in the control connection from an idle FTP client or FTP server when the current transaction has not been completed. For example, if an FTP client opens a control connection and sends some requests, the FTP Proxy waits for the amount of time specified for the client side control connection timeout for the next request before closing the open connection. <ul style="list-style-type: none"> • Client side. The maximum number of seconds the FTP Proxy keeps a control connection open with an idle client. • Server side. The maximum number of seconds the FTP Proxy keeps a control connection open with an idle FTP server. Default is 300 seconds for both client and server side control connection timeouts.

Table 6-2 FTP Proxy Settings (Continued)

Property	Description
Data Connection Timeouts	<p>Enter how long the FTP Proxy waits for more communication in the data connection from an idle FTP client or FTP server when the current transaction has not been completed.</p> <p>For example, if an FTP client opens a data connection and sends only half of the request, the FTP Proxy waits for the amount of time specified for the client side data connection timeout for the rest of the request before closing the open connection.</p> <ul style="list-style-type: none">• Client side. The maximum number of seconds the FTP Proxy keeps a data connection open with an idle client.• Server side. The maximum number of seconds the FTP Proxy keeps a data connection open with an idle FTP server. <p>Default is 300 seconds for both client and server side data connection timeouts.</p>

4. Submit and commit your changes.

BYPASSING THE WEB PROXY

You can configure the Web Security appliance so client requests to or from particular addresses bypass all processing by the Web Proxy. The proxy bypass list only works for requests that are transparently redirected to the Web Proxy using an L4 switch or a WCCP v2 router. When the appliance is deployed in explicit forward mode, or when a client makes an explicit request to the Web Proxy, the request is processed by the Web Proxy.

You might want to create a proxy bypass list to accomplish any of the following:

- Prevent the Web Proxy from interfering with non-HTTP-compliant (or proprietary) protocols using HTTP ports that do not work properly when they connect to a proxy server.
- Ensure that traffic from a particular machine inside the network, such as a malware test machine, bypasses the Web Proxy and all its built-in security protection.

Define the proxy bypass list on the Web Security Manager > Proxy Bypass page.

Figure 6-3 shows a sample proxy bypass list.

Figure 6-3 Proxy Bypass List

Proxy Bypass



Proxy Bypass	
Proxy Bypass List:	10.1.1.1, intranet.example.com, example.com
Edit Settings...	

To include an address in the proxy bypass list, click **Edit Settings**. You can enter multiple addresses separated by line breaks or commas. You can enter addresses using any of the following formats:

- IP address, such as 10.1.1.0
- CIDR address, such as 10.1.1.0/24
- Host name, such as crm.example.com
- domain names, such as example.com

Note — For the proxy bypass list to work with domain names, you need to connect the T1 and T2 network interfaces to the network *even if you do not enable the L4 Traffic Monitor*. For more information, see “How the Proxy Bypass List Works” on page 99.

When transactions bypass the Web Proxy, AsyncOS for Web records them in the proxy bypass logs. For more information about logging, see “Working with Log Subscriptions” on page 448.

Note — If the proxy bypass list contains an address that is a known malware address according to the L4 Traffic Monitor and the L4 Traffic Monitor sees a request for that address, then the request will still be blocked by the L4 Traffic Monitor. If you want to ensure traffic to that address is always allowed, you must also bypass the address from the L4 Traffic Monitor. For more information, see “How the L4 Traffic Monitor Works” on page 407.

How the Proxy Bypass List Works

When the Web Proxy receives an HTTP or HTTPS request, it checks both the source and destination IP address to see if it is in the proxy bypass list. If it is, the packet is sent to the next hop on the network. (In some cases, the packet is sent back to the transparent redirection device that redirected the packet, if the packet arrived on a WCCP service using GRE.)

The proxy bypass list works by matching the IP addresses of the request to an IP address in the proxy bypass list. When names are entered in the bypass list, the Web Proxy must resolve them to an IP address using DNS. The Web Proxy DNS resolves host names differently than domain names:

- **Host names.** Host names are resolved to IP addresses using DNS queries immediately after they are entered into the proxy bypass list. (An example host name is `www.example.com`.)
- **Domain names.** Domain names cannot be resolved to IP addresses using DNS queries, so the Web Proxy uses DNS snooping using the T1 and T2 network interfaces. (An example domain name is `example.com`, and it matches both `www.example.com` and `webmail.example.com`.)

Because of these differences, if the proxy bypass list contains only IP addresses and host names, then the Web Proxy can easily match the IP address in the request header to the IP addresses in the proxy bypass list.

However, for the proxy bypass list to work with domain names, you must connect both the T1 and T2 network interfaces (if using simplex mode) or just connect the T1 network interface (if using duplex mode) to the network *even if you do not enable the L4 Traffic Monitor*. However, the proxy bypass list only bypasses the Web Proxy scanning. It does not bypass the L4 Traffic Monitor.

Note — If the transparent redirection device is a WCCP router, some are intelligent enough to not forward any other packets to the Web Proxy for the same session. In this case, the packets are not physically sent to the Web Proxy for the rest of the session and are truly bypassing it for the rest of the session.

Using WCCP with the Proxy Bypass List

When the Web Security appliance is configured to use a WCCP v2 router, you must ensure that all WCCP services defined in the Web Security appliance use the same forwarding and return method (either L2 or GRE) to work properly with the proxy bypass list. If the forwarding and return methods do not match, some WCCP enabled routers will act inconsistently.

For more information, see “Working with the Forwarding and Return Method” on page 497.

PROXY USAGE AGREEMENT

You can configure the Web Security appliance to inform users that it is filtering and monitoring their web activity. The appliance does this by displaying an end-user acknowledgement page when a user first accesses a browser after a certain period of time. When the end-user acknowledgement page appears, users must click a link to access the original site requested or any other website. For more information about end-user acknowledgement pages, see “End-User Acknowledgement Page” on page 272.

CONFIGURING CLIENT APPLICATIONS TO USE THE WEB PROXY

Web browsers and other user agents sometimes need to know how to connect to the Web Proxy in order to access the World Wide Web. When you deploy the Web Security appliance in explicit forward mode, you *must* configure client applications so they use the Web Proxy. If you deploy the appliance in transparent mode, you can *choose* whether or not to configure client applications to explicitly use the Web Proxy.

You can configure client applications to explicitly use the Web Proxy by using any of the following configuration methods:

- **Manual.** Manual configuration involves typing the Web Security appliance host name and port number, such as 3128, in each client application. If the appliance changes, you must edit each application individually. You might want to manually configure an application when you are testing proxy access on a single client machine. IronPort does not recommend manually configuring each client application to use the appliance Web Proxy.
- **Proxy auto-config (PAC) file.** For web browsers, you can configure each browser to use a PAC file to find the Web Proxy. Then you can edit the PAC file to specify the appliance Web Proxy information. For more information, see “Working with PAC Files” on page 102.

For more information about how to configure client applications to use a proxy, see the client application documentation.

WORKING WITH PAC FILES

A proxy auto-config (PAC) file is a text file that defines how web browsers can automatically choose the appropriate proxy server for fetching a given URL.

When you use a PAC file, you only need to configure each browser once with the PAC file information. Then, you can edit the PAC file multiple times to add, delete, or change Web Proxy connection information without editing each browser. This way you can configure the proxy information about your network in a centralized location and update it easily.

Note — Once a browser has read a PAC file, it stores it in memory for the remainder of the browser session.

You might want to use a PAC file for the following reasons:

- **Centralized management.** You can manage the PAC file in a single, central location.
- **Complex network environment.** If the network of proxy servers is complicated, you can create a PAC file to accommodate different server and client needs.
- **Changing network environment.** If your network environment is likely to change in the future, you can easily add, edit, or delete proxy servers in the PAC and have the changes automatically affect all browsers.
- **Failover.** If you have multiple proxy servers, you can provide redundancy in case of failure. You can either program the PAC file to be redundant, or if a failure occurs, change the PAC file to use a different proxy server.

Note — Different browsers take different amounts of time to fail over to a secondary proxy. For example, Internet Explorer takes about 25 seconds, and Firefox takes about 50 seconds.

- **Load balancing.** If you have multiple proxy servers, you can use the PAC file to specify which requests go to which proxy server. For example, you might want users on one subnet to use a particular proxy and users on a different subnet to use a different proxy.

PAC File Format

The PAC file must include at least one JavaScript function, `FindProxyForURL(url, host)`. The JavaScript function determines the appropriate proxy to use for each URL.

For example, if the Web Security appliance host name is `WSA.example.com`, you could create a PAC file that includes the following text:

```
function FindProxyForURL(url, host) { return "PROXY  
WSA.example.com:3128; DIRECT"; }
```

Note — The port you specify in the `FindProxyForURL()` function should be a proxy port for the Web Security appliance configured on the Security Services > Proxy Settings page.

However, you can make PAC files more complex. For example, you can create a PAC file that instructs the browser to connect directly to the website under certain conditions, such as matching on a particular host name or IP address, and to use the proxy server in all other cases. You can create a PAC file that instructs applications to go directly to the website for servers on your intranet.

For more information about creating and using PAC files, see the following locations:

- http://en.wikipedia.org/wiki/Proxy_auto-config
- <http://www.mozilla.org/catalog/end-user/customizing/enduserPAC.html>
- <http://wp.netscape.com/eng/mozilla/2.0/relnotes/demo/proxy-live.html>

Note — Common convention is to use the .pac file extension for PAC file names.

Creating a PAC File for Remote Users

Some laptop users connect to the Internet both from inside your organization's network and outside the network. For these users, you can create a PAC file that informs the browser to connect to the Web Proxy when they are on the network, and to connect directly to web servers when they are not on the network.

To do this, make sure the PAC file is hosted on a web server that is DNS resolvable inside the network, but not DNS resolvable outside the network. This works because when you enter a URL for the PAC file location, the browser will always try to use the PAC file in the configured location. If the browser cannot resolve the URL, such as when it is outside the network, it tries to access all web sites directly instead. Then when the laptop connects to the network again, the browser can access the PAC file and will use the Web Proxy to access web sites.

Specifying the PAC File in Browsers

To use a PAC file, you must publish the PAC file in a location that can be accessed by each browser that needs to access it. When you configure a browser to use a PAC file, you can use either of the following methods:

- **Enter the PAC file location.** See “Entering the PAC File Location” on page 103.
- **Detect the PAC file location automatically.** See “Detecting the PAC File Location Automatically” on page 104.

Entering the PAC File Location

You can configure a browser to use a PAC file by specifying the exact location of the file. You might want to enter the exact PAC file location for laptop users who might need to use different proxy servers depending on their current location.

You can place the PAC file in the following locations:

- **Local machine.** You can place the PAC file on each client machine and configure the browsers to use it. You might want to use a local PAC file to test a PAC file before deploying it to the entire organization. Enter the path in the browser configuration. The path you enter depends on the browser type.

- **Web server.** You can place the PAC file on a web server that each client machine can access. For example, you can place the PAC file on an Apache or Microsoft IIS web server. Enter the URL in the browser configuration.
- **Web Security appliance.** You can place the PAC file on the Web Security appliance. You might want to put the PAC file on the Web Security appliance to verify every client machine can access it within the network. Enter the URL in the browser configuration. If the URL does not specify the PAC file name, the appliance returns default.pac if it exists.

For more information about uploading PAC files to the Web Security appliance, see “Adding PAC Files to the Web Security Appliance” on page 106.

Detecting the PAC File Location Automatically

If a browser supports the Web Proxy Autodiscovery Protocol (WPAD), you can configure it to automatically detect the PAC file location. WPAD is a protocol that allows the browser determine the location of the PAC file using DHCP and DNS lookups.

Before fetching its first page, a web browser configured to automatically detect the PAC file location tries to find the PAC file using DHCP or DNS. Therefore, to use WPAD, you must set up either a DHCP server or a DNS server to direct web browser requests to the PAC file on a network server. However, not all browsers support DHCP to find the PAC file using WPAD.

This section includes some general guidelines for using WPAD with DNS “A” records. For more detailed information, or for information about using WPAD with DHCP, see the following locations:

- http://en.wikipedia.org/wiki/Web_Proxy_Autodiscovery_Protocol
- <http://www.wpad.com/draft-ietf-wrec-wpad-01.txt>
- <http://www.microsoft.com/technet/isa/2004/plan/automaticdiscovery.mspix>

When you use WPAD with DNS, each domain on the network can only use one PAC file for all users on a domain because only domain name can uniquely identify a PAC file using DNS. For example, users on host1.accounting.example.com and host2.finance.example.com can use different PAC files.

To use WPAD with DNS:

1. Rename the PAC file to wpad.dat.
2. Create an internally resolvable DNS name that starts with “wpad,” such as wpad.example.com.
3. Place wpad.dat in the root directory of the website that will host the file, such as wpad.example.com. For information about placing the file on the Web Security appliance, see “Uploading PAC Files to the Appliance” on page 106.

Note — Due to a bug in Internet Explorer 6, create a copy of wpad.dat and change the file name to wpad.da to work with Internet Explorer 6 users. For more information, see http://www.microsoft.com/technet/isa/2004/ts_wpad.mspix.

4. Configure the web server to set up .dat files with the following MIME type:

`application/x-ns-proxy-autoconfig`

Note — If you place wpad.dat on the Web Security appliance, the appliance does this for you already.

ADDING PAC FILES TO THE WEB SECURITY APPLIANCE

You can configure browsers to explicitly use the Web Proxy by using proxy auto-config (PAC) files. When you use PAC files, you can place them on the Web Security appliance, and then configure the browsers by either entering the URL of a PAC file on the appliance or by configuring the browsers to automatically detect the PAC file using the Web Proxy Autodiscovery Protocol (WPAD).

You can add multiple PAC files to the appliance. You might want to add multiple PAC files if the appliance is used by multiple domains on the network. You can use one PAC file for all browsers on a domain.

When you add a PAC file to the appliance, you can specify one or more ports the appliance uses to listen for PAC file requests.

When a browser asks for a PAC file, the appliance sends back the file using HTTP. The PAC file is returned using MIME type `application/x-ns-proxy-autoconfig`.

Note — When browsers are configured to use a PAC file on the appliance, the URL should include the PAC file name. If the URL does not specify the PAC file name, the appliance uses `default.pac` if it exists and returns an error if it does not.

For more information about PAC files, see “Working with PAC Files” on page 102.

Uploading PAC Files to the Appliance

To store PAC files on the Web Security appliance:

1. Navigate to Security Services > Proxy Auto-Configuration File Hosting, and click **Enable and Edit Settings**.

The Edit Proxy Auto-Configuration File Hosting Settings page appears.

Figure 6-4 Editing the PAC File Host Settings

Edit Proxy Auto-Configuration File Hosting Settings

Proxy Auto-Configuration File Hosting	
<input checked="" type="checkbox"/> Enable Proxy Auto-Config File Hosting	
Basic Settings	
PAC Server Ports:	9001 <small>Enter multiple ports separated with a comma</small>
PAC Files	
Uploaded Files	<input type="text"/> <input type="button" value="Browse..."/> <input type="button" value="Add Row"/> <input type="button" value="Trash"/>

2. In the PAC Server Ports field, enter one or more port numbers the Web Security appliance should use to listen for PAC file requests.

Note — Verify that the ports you use here are not listed as an HTTP port to proxy on the Security Services > Proxy Settings page. For example, if you want to use port 80 as the

PAC server port, you must first delete port 80 from the HTTP Ports to Proxy field if configured.

3. Click **Browse** to upload a PAC file from your local machine to the appliance.
4. Navigate to the PAC file location, select it, and click **Open**.
5. If you want to add another PAC file, click **Add Row**, and repeat steps 3 through 4.
6. Submit and commit your changes.

WPAD Compatibility with Netscape and Firefox

Netscape and Firefox browsers only use DNS to automatically detect PAC files using WPAD. Therefore, if you want Netscape and Firefox browsers to automatically detect a PAC file stored on the Web Security appliance, you must complete the following steps:

- Name the PAC file wpad.dat.
- Go to the Security Services > Proxy Settings page, and remove port 80 from the HTTP Ports to Proxy field.
- Use port 80 as the PAC Server Port when you upload the file to the appliance.

For more information about using WPAD, see “Detecting the PAC File Location Automatically” on page 104.

Note — The steps listed here also work with Internet Explorer, however, for Internet Explorer version 6, you should create a copy of wpad.dat and name it wpad.da.

ADVANCED PROXY CONFIGURATION

AsyncOS includes the `advancedproxyconfig` CLI command so you can configure more advanced Web Proxy configurations, such as authentication and DNS parameters.

The `advancedproxyconfig` command includes the following subcommands:

- **Authentication.** Configure authentication parameters, such as the number of outstanding concurrent Basic or NTLMSSP authentication requests to be authenticated by the authentication server and whether or not to log the username that appears in the request URI. You can also use the `authentication` subcommand to enable the user acknowledgment page. For more information about the user acknowledgment page, see “Proxy Usage Agreement” on page 100.
- **Caching.** Configure advanced Web Proxy caching options, such as:
 - Whether or not to ignore client requests to not retrieve content from the proxy cache
 - Whether or not to cache content from an untrusted server

You can configure the parameters separately by selecting “Customized Mode,” or you can choose a predefined set of parameter values. You can choose the following modes:

- **Safe mode.** This mode uses less caching.
- **Optimized mode.** This mode uses moderate caching.
- **Aggressive mode.** This mode uses aggressive caching.
- **DNS.** Configure DNS-related options, such as the time to cache results of DNS errors and whether or not the Web Proxy should issue an HTTP 302 redirection on DNS lookup failure.
- **NATIVEFTP.** Configure the FTP Proxy settings, such as the port ranges to use for active and passive mode and the type of authentication to use for explicit forward connections. Applies to native FTP transactions only. For more information on configuring the FTP Proxy, see “Configuring FTP Proxy Settings” on page 94.
- **FTPOVERHTTP.** Configure the login name and password to use for anonymous FTP access and whether or not to allow active mode for FTP transfers. Applies to FTP over HTTP transactions only.
- **HTTPS.** Configure the logging style for URIs used in HTTPS transactions. You can choose to record the full URI (“fulluri”) or just a portion of the URI with the query portion removed (“stripquery”).
- **WCCP.** Configure the amount of logging detail to use to debug WCCP related issues.
- **Miscellaneous.** Configure whether or not the Web Proxy should respond to health checks from L4 switches and whether or not the Web Proxy should perform dynamic adjustment of TCP receive window sizes.

Each submenu command is discussed in the detail tables below. For the Default Value column, a string means a name or list of characters such as “hello world.”

Authentication Options

Table 6-3 describes the authentication options for the `advancedproxyconfig` CLI command.

Table 6-3 `advancedproxyconfig` CLI Command—Authentication Options

Option	Valid Values	Default Value	Must Restart Web Proxy?	Description
When would you like to forward authorization request headers to a parent proxy?	Never, Always, Only if not used by the WSA	Never	Yes	This setting determines whether the Web Proxy includes the “Proxy-Authorization” header to upstream servers, including proxies.
Enter the Proxy Authorization Realm to be displayed in the end user authentication dialog	String	“IronPort Web Security Appliance”	No	Proxy Authorization Realm displayed in the End User Authentication dialog.
Would you like to log the username that appears in the request URI?	Yes, No (Boolean)	No	No	If enabled, ‘<username>:xxxxx’ is logged i.e the username is displayed and the password is represented as a string, ‘xxxxx’. If disabled, both username and password are stripped. Note that the actual password is never displayed regardless of the value of this variable.
Would you like to turn on presentation of the User Acknowledgement page?	Yes, No (Boolean)	No	No	Enable or disable Acknowledgement page.
Enter maximum time to remember User Acknowledgement (in seconds):	30 - 2678400	86400	No	Maximum time to remember User Acknowledgement. From 30 seconds to one month (2678400).
Enter maximum idle timeout for User Acknowledgement based on IP Address (in seconds):	30 - 2678400	14400	No	Maximum idle timeout for User Acknowledgement based on IP Address. From 30 seconds to one month (2678400).

Table 6-3 advancedproxyconfig CLI Command—Authentication Options (Continued)

Option	Valid Values	Default Value	Must Restart Web Proxy?	Description
Should the Group Membership attribute be used for directory lookups in the Web UI (when it is not used, empty groups and groups with different membership attributes will be displayed)?	Yes, No (Boolean)	No	No	Choose whether or not AsyncOS should use the group membership attribute when doing a directory lookup. If you do not want to display empty authentication groups and fetch groups whose group membership attribute is different, choose Yes.
Would you like to enable referrals for LDAP?	Yes, No (Boolean)	No	Yes	Choose whether or not the Web Proxy should perform LDAP queries on a referred LDAP server. You might want to disable this option if a referred LDAP server is unavailable to the Web Security appliance.
Would you like to enable secure authentication?	Yes, No (Boolean)	No	Yes/No (Web Proxy restarts when it needs to listen on fewer or additional ports)	Choose whether or not the Web Proxy redirects clients to securely pass authentication credentials to the Web Proxy using HTTPS. For more information on this feature, see "Sending Authentication Credentials Securely" on page 383.
Would you like to use surrogates for explicit forward mode requests?	Yes, No (Boolean)	No	No	Choose whether or not to configure surrogate properties when the appliance is deployed in explicit forward mode even when secure authentication is not enabled. When you choose Yes, the CLI presents additional options you can configure. Note: This option only appears when you disable secure authentication.

Table 6-3 advancedproxyconfig CLI Command—Authentication Options (Continued)

Option	Valid Values	Default Value	Must Restart Web Proxy?	Description
Enter the redirect port for secure authentication.	1 to 65535	443	Yes/No (Web Proxy restarts when it needs to listen on fewer or additional ports)	Enter the port to use for redirecting requests using HTTPS. IronPort recommends using a port greater than 1023. For more information on configuring this option, see “Configuring Global Authentication Settings” on page 373. Note: This option only appears when you enable secure authentication.
Enter surrogate type for authentication.	Cookie, IP	Cookie	No	This setting specifies the way that transactions used for authenticating the client are associated with a user (either by IP address or using a cookie) after the user has authenticated successfully. For more information on configuring this option, see “Configuring Global Authentication Settings” on page 373.
Enter the authentication cookie type.	Persistent, Session	Persistent	No	When you choose cookie as the surrogate type for authentication, you can choose either persistent or session cookies. For more information on configuring this option, see “Configuring Global Authentication Settings” on page 373.

Table 6-3 advancedproxyconfig CLI Command—Authentication Options (Continued)

Option	Valid Values	Default Value	Must Restart Web Proxy?	Description
Enter the hostname to redirect clients for authentication.	String	Appliance host name	No	<p>Enter the short host name of the network interface on which the Web Proxy listens for incoming connections.</p> <p>When you enable secure authentication, the Web Proxy uses this host name in the redirection URL sent to clients for authenticating users.</p> <p>For more information on configuring this option, see “Configuring Global Authentication Settings” on page 373.</p>
Enter the surrogate timeout.	Time in seconds	3600	No	<p>This setting specifies how long the surrogate (IP address or cookie) can be used before requiring authentication credentials again.</p> <p>For more information on configuring this option, see “Configuring Global Authentication Settings” on page 373.</p>

Table 6-3 advancedproxyconfig CLI Command—Authentication Options (Continued)

Option	Valid Values	Default Value	Must Restart Web Proxy?	Description
Enter re-auth on request denied option [disabled / embedlinkinblockpage]?	disabled/ embedlinkinblockpage	disabled	No	<p>This setting allows users to authenticate again if the user is blocked from a website due to a restrictive URL filtering policy. The user sees a block page that includes a link that allows them to enter new authentication credentials. If the user enters credentials that allow greater access, the requested page appears in the browser.</p> <p>Note: This setting only applies to authenticated users who are blocked due to restrictive URL filtering policies. It does not apply to blocked transactions by subnet with no authentication. For more information, see “Allowing Users to Re-Authenticate” on page 386.</p>
Enter the charset to be used for basic authentication [ISO-8859-1/UTF-8].	ISO-8859-1, UTF-8	ISO-8859-1	No	<p>Choose the character encoding that the Web Proxy should use when reading the Basic authentication credentials in the HTTP request. The setting configured here does not affect the request content, only the Basic authentication credentials.</p> <p>You might want to use ISO-8859-1 if most web browsers used on your network are Internet Explorer, Firefox, and Safari, and UTF-8 if most web browsers on your network are Opera and Chrome.</p> <p>Note: The Web Proxy always uses UTF-8 when sending the Basic authentication credentials to the authentication server.</p>

Table 6-3 advancedproxyconfig CLI Command—Authentication Options (Continued)

Option	Valid Values	Default Value	Must Restart Web Proxy?	Description
Would you like to send Negotiate header along with NTLM header for NTLMSSP authentication: 1. Do not send Negotiate header 2. Send Negotiate header	1, 2	1	No	Choose whether or not to send the "Proxy-Authenticate: Negotiate" header when the Web Proxy uses NTLMSSP authentication. You might want to send this header to maintain compatibility with older user agents. You might want to not send the header to allow .NET applications to work properly with NTLMSSP authentication.
Would you like to allow wild card matching with the character * for LDAP group names?	Yes, No (Boolean)	Yes	Yes	Choose whether or not to match an asterisk as a wildcard in LDAP group filters. When this option is disabled, using an asterisk (*) in the group filters for LDAP servers works as a literal string.

Caching Options

The Caching submenu provides four options to set the advanced caching mode.

Table 6-4 describes the caching options for the Customized Mode option in the advancedproxyconfig CLI command.

Table 6-4 advancedproxyconfig CLI Command—Caching Options

Option	Valid Values	Default Value	Must Restart Web Proxy?	Description
Would you like to allow objects with a heuristic expiration time to be served as not-modified If-Modified-Since hits from cache?	Yes, No (Boolean)	Yes	No	0 = favor freshness on IMS to objects with heuristic expiration time 1 = favor bandwidth conservation

Table 6-4 advancedproxyconfig CLI Command—Caching Options (Continued)

Option	Valid Values	Default Value	Must Restart Web Proxy?	Description
Would you like to allow ETAG mismatch on client revalidations?	Yes, No (Boolean)	No	No	In some cases, the server might report different ETags for the same version of the same file. This can be seen, for example, with clustered IIS servers. In these cases, requiring both a last modified time (LMT) match and an ETag match on client revalidations would lead to a lot of misses, so it should be sufficient just to match the LMT if it is given. Note: Setting this to 1 is not HTTP-compliant.
Would you like to allow caching when requests are authenticated by the origin server?	Yes, No (Boolean)	No	Yes	Allow caching for requests authenticated by origin server.
Would you like to allow caching from servers whose DNS results do not match the TCP destination IP (not trustworthy and applicable only in transparent modes)?	Yes, No (Boolean)	No	Yes	Allow caching from servers whose DNS results do not match the TCP destination IP.
Enter the Heuristic maximum age to cache the document with Last-Modified Time but no actual caching value (in seconds):	Time in seconds	86400	No	Heuristic maximum age to cache the document with LMT but no actual caching value.
Enter the Heuristic maximum age to cache the document without Last-Modified Time and no actual caching value (in seconds):	Time in seconds	0	No	Heuristic maximum age to cache the document without LMT and no actual caching value.

Table 6-4 advancedproxyconfig CLI Command—Caching Options (Continued)

Option	Valid Values	Default Value	Must Restart Web Proxy?	Description
Enter the Heuristic age to cache errors (HTTP_SERVICE_UNAVAIL, HTTP_GATEWAY_TIMEOUT etc) (in seconds):	Time in seconds	300	No	Heuristic age to cache errors (HTTP_SERVICE_UNAVAIL, HTTP_GATEWAY_TIMEOUT etc).
Would you like proxy to ignore client directive to not fetch content from the cache?	Yes, No (Boolean)	No	No	Disable/Enable ignoring of the client directive to not fetch content from the cache. Enabling this is not HTTP compliant.
Enter the time interval during which reload requests must be ignored by the proxy (in seconds):	Time in seconds	0	No	Disable/Enable reload requests to be ignored for the specified time interval. This allows reload requests to be ignored for a certain amount of time, even though it is not HTTP-compliant. You might want to enter a value greater than zero to improve bandwidth usage.
Would you like to allow proxy to convert reload requests into max-age requests?	Yes, No (Boolean)	No	No	Allow reload requests to be converted into max-age requests (not HTTP-compliant, but may improve bandwidth usage). This gets its max-age value from "ignoreReloadTime."
Time in seconds after which an explicit IMS Refresh request must be issued:	Time in seconds	300	No	Time in seconds after which an explicit IMS Refresh request must be issued.

DNS Options

Table 6-5 describes the DNS options for the `advancedproxyconfig` CLI command.

Table 6-5 `advancedproxyconfig` CLI Command—DNS Options

Option	Valid Values	Default Value	Must Restart Web Proxy?	Description
Enter the time to cache successful DNS results if DNS does not provide TTL (in seconds):	0 - 86400	300	No	Time to cache successful DNS results if DNS does not provide TTL.
Enter the time to cache results of DNS errors (negative DNS caching) (in seconds):	0 - 86400	30	No	Set to 0 to be HTTP compliant.
Enter the URL format for the HTTP 307 redirection on DNS lookup failure:	String with EUN page variables	%P//www.%H.com/%u	No	URL format for the HTTP 307 redirection on DNS lookup failure. See Table 13-2, "Variables for Customized End-User Notification Pages," on page 264 for the list of valid variables.
Would you like the proxy to issue a HTTP 307 redirection on DNS lookup failure?	Yes, No (Boolean)	Yes	Yes	Disable/Enable automatic HTTP 307 redirection on DNS lookup failure.
Would you like proxy not to automatically failover to DNS results when upstream proxy (peer) is unresponsive?	Yes, No (Boolean)	No	Yes	Disable/Enable automatic failover to DNS results when upstream proxy (peer) is unresponsive.
Find web server by: 0 = use DNS answers in order, 1 = use client supplied address then DNS, 2 = use ONLY client supplied address:	0, 1, 2	1	Yes	Specify how the appliance should find the location of the requested web server.

NATIVEFTP Options

Table 6-6 describes the NATIVEFTP options for the `advancedproxyconfig` CLI command.

Table 6-6 `advancedproxyconfig` CLI Command—NATIVEFTP Options

Option	Valid Values	Default Value	Must Restart Web Proxy?	Description
Would you like to enable FTP proxy?	Yes, No (Boolean)	Yes	Yes	Choose whether or not to enable the FTP Proxy.
Enter the ports that FTP proxy listens on.	1 to 65535	8021	Yes	Specify the port FTP clients should use to establish a control connection with the FTP Proxy.
Enter the range of port numbers for the proxy to listen on for passive FTP connections.	port1- port2 (string) 1024 - 65535	11000-11009]	Yes	Specify a range of TCP ports FTP clients should use to establish a data connection with the FTP Proxy for passive mode connections.
Enter the range of port numbers for the proxy to listen on for active FTP connections.	port1- port2 (string) 1024 - 65535	12000-12009	Yes	Specify a range of TCP ports FTP servers should use to establish a data connection with the FTP Proxy for active mode connections.
Would you like to use active mode when passive mode fails?	Yes, No (Boolean)	No	No	When this option is enabled, the FTP Proxy will attempt an active mode connection with the FTP server when passive mode fails.
Enter the authentication format:	Check Point, Raptor	Check Point	Yes	Choose the authentication format the FTP Proxy uses when communicating with FTP clients. For more information, see "Using Authentication with Native FTP" on page 93.
Would you like to enable caching?	Yes, No (Boolean)	Yes	Yes	Choose whether or not to cache contents of data connections from anonymous users.

Table 6-6 advancedproxyconfig CLI Command—NATIVEFTP Options (Continued)

Option	Valid Values	Default Value	Must Restart Web Proxy?	Description
Would you like to enable server IP spoofing?	Yes, No (Boolean)	No	Yes	Choose whether or not the FTP Proxy should spoof the FTP server IP address. You might want to do this for FTP clients that do not allow transactions when the IP address is different for the control and data connections.
Would you like to pass FTP server welcome message to the clients?	Yes, No (Boolean)	Yes	Yes	Choose which welcome message should be displayed in FTP clients: <ul style="list-style-type: none"> • FTP server message. Enter “Yes.” The FTP server message only displays for transparently redirected connections. When a native FTP connection is explicitly sent to the FTP Proxy, the FTP client displays a message predefined by the FTP Proxy. • Custom message. Enter “No.” You can enter a custom message to display for all native FTP connections in the next question.
Enter the customized server welcome message.	String	N/A	Yes	This command appears when you enter No for the FTP server welcome message. Enter the custom message to display for all native FTP connections.

FTPOVERHTTP Options

Table 6-7 describes the FTPOVERHTTP options for the `advancedproxyconfig` CLI command.

Table 6-7 `advancedproxyconfig` CLI Command—FTPOVERHTTP Options

Option	Valid Values	Default Value	Must Restart Web Proxy?	Description
Enter the login name to be used for anonymous FTP access:	String	anonymous	No	Anonymous FTP login name.
Enter the password to be used for anonymous FTP access:	String	proxy@	No	Anonymous FTP login password.
Would you like to use active FTP transfer mode when passive mode fails?	Yes, No (Boolean)	No	No	Choose whether or not to allow FTP transfers to use active mode if passive mode fails.
Enter the range of port numbers for the proxy to listen on for active FTP connections.	port1-port2 (string) 1024 - 65535	10000 - 10001	No	When you enable active mode for FTP transfers, enter the range of TCP ports the appliance can use for establishing a data connection. If a port is being used, the Web Proxy chooses the next port in the range until it finds an available port.

HTTPS Options

Table 6-8 describes the HTTPS options for the `advancedproxyconfig` CLI command.

Table 6-8 `advancedproxyconfig` CLI Command—HTTPS Options

Option	Valid Values	Default Value	Must Restart Web Proxy?	Description
HTTPS URI Logging Style:	fulluri or stripquery	fulluri	Yes	You can log the entire URI (fulluri), or a partial form of the URI with the query portion removed (stripquery). However, even when you choose to strip the query from the URI, personally identifiable information may still remain.

WCCP Options

Table 6-9 describes the WCCP options for the `advancedproxyconfig` CLI command.

Table 6-9 `advancedproxyconfig` CLI Command—WCCP Options

Option	Valid Values	Default Value	Must Restart Web Proxy?	Description
Enter the log level for debugging WCCP:	0 - 10	0	Yes	WCCP log level

Miscellaneous Options

Table 6-10 describes the miscellaneous options for the `advancedproxyconfig` CLI command.

Table 6-10 `advancedproxyconfig` CLI Command—Miscellaneous Options

Option	Valid Values	Default Value	Must Restart Web Proxy?	Description
Would you like proxy to respond to health checks from L4 switches (always enabled if WSA is in L4 transparent mode)?	Yes, No (Boolean)	No	Yes	Disable/Enable support for responding to health checks from L4 switches (always enabled if WSA is in L4 transparent mode). L4 switches issue 'HEAD / HTTP/1.0' requests directed at the proxy to ensure that it is responding.
Would you like proxy to perform dynamic adjustment of TCP receive window size?	Yes, No (Boolean)	Yes	Yes	Disable/Enable dynamic adjustment of TCP receive window size.
Enable custom EUN pages?	Yes, No (Boolean)	No	Yes	Choose whether or not to enable the ability to upload user-defined end-user notification pages to the appliance using FTP. For more information, see "Editing IronPort Notification Pages" on page 264.
Enable caching of HTTPS responses?	Yes, No (Boolean)	No	No	Choose whether or not the Web Security appliance should store HTTPS responses in the web cache.

Table 6-10 advancedproxyconfig CLI Command—Miscellaneous Options (Continued)

Option	Valid Values	Default Value	Must Restart Web Proxy?	Description
Enter minimum idle timeout for checking unresponsive upstream proxy (in seconds).	Time in seconds	10	No	The minimum amount of time the Web Proxy waits before checking if an upstream proxy is still unavailable.
Enter maximum idle timeout for checking unresponsive upstream proxy (in seconds).	Time in seconds	86400	No	The maximum amount of time the Web Proxy waits before checking if an upstream proxy is still unavailable.
Mode of the proxy:	1, 2, 3	2	Yes	Choose how to deploy the Web Proxy using one of the following options: 1. Explicit forward mode only 2. Transparent mode with L4 Switch or no device for redirection 3. Transparent mode with WCCP v2 Router for redirection For more information, see "Deployment Overview" on page 28.
Spoofing of the client IP by the proxy:	1, 2, 3	1		Choose whether or not the Web Proxy should spoof IP addresses when sending requests to upstream proxies and servers using one of the following options: 1. Disable 2. Enable for all requests 3. Enable for transparent requests only When IP spoofing is enabled, requests originating from a client retain the client's source address and appear to originate from the client rather than from the Web Security appliance. Note: When IP spoofing is enabled and the appliance is connected to a WCCP router, configure a WCCP service to redirect the return path.

Table 6-10 advancedproxyconfig CLI Command—Miscellaneous Options (Continued)

Option	Valid Values	Default Value	Must Restart Web Proxy?	Description
Do you want to pass HTTP X-Forwarded-For headers?	Yes, No (Boolean)	Yes	No	Choose whether or not the Web Proxy retains any “X-Forwarded-For” header included in the requests it receives. When set to No, the Web Proxy removes any “X-Forwarded-For” header from requests that enter the Web Proxy from a downstream proxy server. You might want to do this if the downstream proxy server includes client IP address in the header and you do not want to expose those IP addresses to servers outside your network.
Would you like to permit tunneling of non-http requests on http ports?	Yes, No (Boolean)	No	Yes	Choose whether or not to allow non-HTTP traffic on ports the Web Proxy is configured to monitor, such as port 80. This option applies when the Web Proxy is in transparent mode. Enabling this option blocks applications that attempt to tunnel non-HTTP traffic on ports typically used for HTTP traffic. Note: When a transaction is blocked due to this setting, the ACL decision tag for the transaction is logged as BLOCK_ADMIN_TUNNELING.

Working with Policies

This chapter contains the following information:

- “Working with Policies Overview” on page 126
- “Policy Types” on page 127
- “Working with Policy Groups” on page 130
- “Policy Group Membership” on page 133
- “Working with Time Based Policies” on page 136
- “Working with User Agent Based Policies” on page 138
- “Tracing Policies” on page 141

WORKING WITH POLICIES OVERVIEW

The Web Security appliance allows you to define policies to enforce your organization's acceptable use policies by controlling access to the Internet. You can create groups of users and apply different levels and types of access control to each group.

For example, you can configure the appliance to enforce the following types of policies:

- Users in the Marketing group can access a competitor's website, but other users cannot.
- Guest users on customer-facing machines, such as computers in a company store, cannot access banking sites, but employees can.
- No users can access gambling sites. Instead, when they try to view a gambling site, they see a web page that explains the organization's policies.
- All users trying to access a particular site that no longer exists are redirected to a different site.
- All users except those in IT are blocked from accessing potential malware sites, but users in IT can access them for testing purposes, and the downloaded content is scanned for harmful objects.
- All requests for streaming media are blocked during business hours, but allowed outside of business hours.
- All requests from a particular user agent, such as a software update program, are allowed without requiring authentication.
- Block uploads of all Excel spreadsheet files greater than 2 MB.
- Block uploads of data to sites with a bad web reputation.

To enforce organizational policies, you define different policies in the Web Security appliance. The appliance uses different types of policies for different functions. For more information about the types of policies, see "Policy Types" on page 127.

When you work with policies, you create policy groups. After you create policy groups, you can define the control settings for each group. For more information about working with policy groups, see "Working with Policy Groups" on page 130.

After you have created policies, you can figure out which policy groups apply to a particular client transaction for troubleshooting purposes. For example, you can find out if user jsmith tries to open a Firefox browser to the URL <http://www.google.com>, then which policy groups apply to the transaction. For more information about tracing policies, see "Tracing Policies" on page 141.

Note — The Web Security appliance is permissive by default. That is, requests are allowed unless specifically blocked in a policy group.

POLICY TYPES

The Web Security appliance uses multiple types of policies to enforce organizational policies and requirements.

- **Identities.** “Who are you?”
- **Decryption Policies.** “To decrypt or not to decrypt?”
- **Routing Policies.** “From where to fetch content?”
- **Access Policies.** “To allow or block the transaction?”
- **IronPort Data Security Policies.** “To block the upload of data?” IronPort Data Security Policies actions are defined on the Web Security appliance.
- **External DLP (data loss prevention) Policies.** “To block the upload of data?” External DLP Policies actions are defined on an external DLP appliance.

You use the policies together to create the behavior you need or expect when clients access the web.

To define policies, you create policy groups. After you create policy groups, you can define the control settings for each group. For more information about working with policy groups, see “Working with Policy Groups” on page 130.

All policy types have a global policy group that maintains default settings and rules that apply to web transactions not covered by another policy. For more information on global policies, see “Working with Policy Groups” on page 130.

Identities

An Identity is a policy that identifies the user making a request. This is the only policy where you can define whether or not authentication is required. An Identity addresses the question, “who are you?” However, Identities do *not* specify a list of users who are *authorized* to access the web. You specify authorized users in the other policy types after you specify the Identity to use.

All other policies you create must specify an Identity.

Configure Identities on the Web Security Manager > Identities page. For more information about Identities, see “Identities” on page 145.

Decryption Policies

Decryption Policies determine whether or not an HTTPS connection should be decrypted, passed through, or dropped. They address the question, “to decrypt or not to decrypt?”

The appliance uses Decryption Policies to evaluate HTTPS requests. The Decryption Policy group that applies to an HTTPS request determines whether the appliance drops the connection, passes it through without decryption, or decrypts the connection and subsequently evaluate the decrypted request and response against the defined Access Policy groups.

Configure Decryption Policy groups on the Web Security Manager > Decryption Policies page. For more information about Decryption Policy groups, see “Decryption Policies” on page 199.

Routing Policies

Routing Policies determine to where to pass the client request, either to another proxy or to the destination server. They address the question, “from where to fetch content?”

You can use this policy type to select a group of upstream proxies configured for load balancing or failover.

Configure Routing Policies on the Web Security Manager > Routing Policies page. For more information about Routing Policies, see “Working with External Proxies” on page 187.

Access Policies

Access Policies determine whether to allow or block HTTP and decrypted HTTPS transactions. They address the question, “to allow or block the transaction?”

Access Policies determine how the appliance controls access to services, applications, and objects on the web for HTTP and decrypted HTTPS requests. The appliance uses Access Policies to evaluate and scan HTTP requests and HTTPS requests designated for decryption.

Configure Access Policy groups on the Web Security Manager > Access Policies page. For more information about Access Policy groups, see “Access Policies” on page 169.

IronPort Data Security Policies

IronPort Data Security Policies determine whether or not to block a request to upload data using logic defined on the Web Security appliance. They address the question, “to block the upload of data?”

The Web Proxy uses IronPort Data Security Policies to evaluate and scan HTTP requests and decrypted HTTPS requests that have any data in the request body.

Configure Data Security Policy groups on the Web Security Manager > IronPort Data Security Policies page. For more information about Data Security Policy groups, see “Data Security and External DLP Policies” on page 233.

External DLP Policies

External DLP (data loss prevention) policies determine whether or not to block a request to upload data using logic stored on an external DLP server. They address the question, “to block the upload of data?”

The Web Proxy uses External DLP Policies to evaluate HTTP requests and decrypted HTTPS requests that have any data in the request body and send them to an external DLP server for scanning.

Configure External DLP Policy groups on the Web Security Manager > External DLP Policies page. For more information about External DLP Policy groups, see “Data Security and External DLP Policies” on page 233.

WORKING WITH POLICY GROUPS

A policy group is an administrator defined configuration that allows you to apply acceptable use policies to specific categories of users. After you create policy groups, you can define the control settings for each group.

You can create as many user defined policy groups as required to enforce the proper access control. The Web Security appliance displays policy groups together in a policies table.

All policies have a default, global policy group that applies to a transaction if none of the user defined policy groups apply. A global policy group maintains default settings and rules that apply to web transactions not covered by another policy. This group appears in the last row of a policies table, and the Web Proxy applies its rules last if no other matching occurs.

Creating Policy Groups

You can create policy groups based on combinations of several criteria, such as client subnet or the URL category of the destination site. You must define at least one criterion for policy group membership. When you define multiple criteria, the client request must meet all criteria to match the policy group.

Options used to configure policy groups allow you to specify exceptions to global policy settings and control access to services for groups of users.

For more information about creating policy groups for the different policy types, see the following locations:

- “Creating Identities” on page 158
- “Creating Access Policies” on page 174
- “Creating Decryption Policies” on page 223
- “Creating Routing Policies” on page 195
- “Creating Data Security and External DLP Policies” on page 241

Using the Policies Tables

The policies table is an ordered list of policy groups and the settings you configure for each filtering component. It displays policy groups by row and control settings by column. The control settings you can define vary by policy type.

Figure 7-1 on page 131 shows the Access Policies table.

Figure 7-1 Access Policies Table

Access Policies

Order	Group	Applications	URL Categories	Objects	Web Reputation and Anti-Malware Filtering	Delete
1	examplePolicy1 Identity: TestLab	Allow: FTP over HTTP, HTTP, HTTPS, Native FTP Allow: Ports 8080, 21,...	Redirect: 0 Allow: 0 Monitor: 46 Warn: 0 Block: 7 Time-Based: 0	Block: Object Types HTTP/HTTPS Object Max Size: None FTP Object Max Size: None	(global policy)	
2	examplePolicy2 Identity: NTLMUsers	Allow: FTP over HTTP, HTTP, HTTPS, Native FTP Allow: Ports 8080, 21,...	(global policy)	(global policy)	(global policy)	
	Global Policy Identity: All	Block: FTP over HTTP, HTTP, HTTPS, Native FTP Allow: Ports 20, 21,...	Redirect: 0 Allow: 0 Monitor: 53 Warn: 0 Block: 0 Time-Based: 0	HTTP/HTTPS Object Max Size: None FTP Object Max Size: None	(enabled)	

Policy Disabled

Click to edit user defined policy group membership.

Global policy group (not editable).

Click to customize policy control settings.

Figure 7-2 shows the Decryption Policies table.

Figure 7-2 Decryption Policies Table

Decryption Policies

Order	Group ?	URL Categories	Web Reputation	Default Action	Delete
1	DecryptionPolicy1 Identity: NTLMUsers	Pass Through: 0 Monitor: 48 Decrypt: 3 Drop: 2 Time-Based: 0	(global policy)	Global Policy	
	Global Policy Identity: All	Pass Through: 0 Monitor: 53 Decrypt: 0 Drop: 0 Time-Based: 0	Enabled	Decrypt	

Policy Disabled

(When enabled, authentication is applicable to forward connections and pre-established transparent IP-based credentials only.)

Click to edit user defined policy group membership.

Global policy group (not editable).

Click to customize policy control settings.

Any policy group that you create is added as a new row in the policies table. New policy groups inherit global policy settings for each control setting until you override them. To edit policy groups, click the links in each row.

When you create or configure a policy group, you define the following components:

- **Policy group membership.** Define how to group users that belong to the policy group. For user defined policy groups, you can group by different properties, such as client IP

address, authentication group or user name, or URL category. The properties you can define for a policy depends on the policy type.

Click the policy group name to edit the group membership requirements, such as client IP address and authentication requirements. A page is displayed where you can configure membership requirements.

Note — For global policies, you can only define the membership requirements for the global Identity group and not for the global Access, Decryption, or Routing groups. Global Access, Decryption, and Routing groups always match all Identities.

For more information about policy group membership, see “Policy Group Membership” on page 133.

- **Policy group control settings.** Define how users in the group can use the Internet. The control settings you can define depend on the policy type. For example, for Routing Policies, you define from which proxy group to fetch the content, and for Access Policies, you can use the Web Security appliance features, such as Web Reputation, anti-malware scanning, and more to determine whether or not to allow the client request.

Click the link in the policy group row under the control setting you want to configure, such as URL Categories or Routing Destination. When you click a link in the table, a page is displayed where you can configure settings for that policy group.

For more information on configuring control settings for each policy type, see the following sections:

- “Controlling HTTP and Native FTP Traffic” on page 177
- “Controlling HTTPS Traffic” on page 227
- “Creating Routing Policies” on page 195
- “Controlling Upload Requests Using IronPort Data Security Policies” on page 245
- “Controlling Upload Requests Using External DLP Policies” on page 252

POLICY GROUP MEMBERSHIP

All policy groups define which transactions apply to them. When a client sends a request to a server, the Web Proxy receives the request, evaluates it, and determines to which policy group it belongs. The Web Proxy applies the configured policy control settings to a client request based on the client request's policy group membership.

Transactions belong to a policy group for each type of policy that is enabled. If a policy type has no user defined policy groups, then each transaction belongs to the global policy group for that policy type.

Policy group membership for a Routing, Decryption, Access, Data Security, and External DLP Policies is based on an Identity and optional additional criteria. That means that *the Web Proxy evaluates Identity groups before the other policy types*. The Web Security appliance allows you to define some membership criteria at either the Identity level or the non-Identity policy level. For more information, see "Policy Group Membership Rules and Guidelines" on page 135.

Suppose you define an Identity by subnet 10.1.1.0/24 and then create an Access Policy using that Identity. The Access Policy membership applies to all IP addresses specified in the Identity by default. You can then choose to configure the Access Policy membership so that it applies to a subset of the addresses defined in the Identity, such as addresses 10.1.1.0-15.

For more information defining membership for each policy type, see the following sections:

- "Evaluating Identity Group Membership" on page 147
- "Evaluating Access Policy Group Membership" on page 172
- "Evaluating Decryption Policy Group Membership" on page 221
- "Evaluating Routing Policy Group Membership" on page 193
- "Evaluating Data Security and External DLP Policy Group Membership" on page 239

Authenticating Users versus Authorizing Users

The Web Security appliance separates where it authenticates users from where it authorizes users.

Authentication is the mechanism by which the Web Proxy securely identifies a user. It answers the following questions:

- Who is the user?
- Is the user really whom he/she claims to be?

Authorization is the mechanism by which the Web Proxy determines the level of access the user has to the World Wide Web. It answers the following questions:

- Is this user allowed to view this website?
- Is this user allowed to connect to this HTTPS server without the connection being decrypted?

- Is this user allowed to directly connect to the web server, or must it connect to another proxy server first?
- Is this user allowed to upload this data?

The Web Proxy can only authorize a user to access an Internet resource *after* it authenticates who the user is. The Web Proxy authenticates users when it evaluates Identity groups, and it authorizes users when it evaluates all other policy group types. What that means is the Identity group indicates who is making the request, but does not indicate whether that client is allowed to make the request.

By separating authentication from authorization, you can create a single Identity group that identifies a group of users and then you can create multiple policy groups that allow different levels of access to subsets of users in the group in the Identity.

For example, you can create one Identity group that covers all users in an authentication sequence. Then you can create an Access Policy group for each authentication realm in the sequence. You can also use this Identity to create one Decryption Policy with the same level of access for all users in the Identity.

Working with Failed Authentication and Authorization

You can allow users another opportunity to access the web if they fail authentication or authorization. How you configure the Web Security appliance depends on what fails:

- **Authentication.** When authentication fails, you can grant guest access to the user. Authentication might fail under the following circumstances:
 - A new hire has been provided credentials in an email but they are not yet populated in the authentication server.
 - A visitor comes to the office and needs to be granted restrictive Internet access, but is not in the corporate user directory.

For more information on configuring guest access, see “Allowing Guest Access to Users Who Fail Authentication” on page 155.

- **Authorization.** A user might authenticate correctly, but not be granted access to the web due to the applicable Access Policy. In this case, you can allow the user to re-authenticate with more privileged credentials. To do this, enable the “Enable Re-Authentication Prompt If End User Blocked by URL Category” global authentication setting. For more information, see “Allowing Users to Re-Authenticate” on page 386.

Working with All Identities

You can create a policy group that specifies “All Identities” as the configured Identity group. “All Identities” applies to every valid client request because by definition, every request either succeeds and has a user defined or global Identity assigned to it or is terminated because it fails authentication (and no guest access was provided for users failing authentication).

When you create a policy group that uses All Identities, you must configure at least one advanced option to distinguish the policy group from the global policy group.

Typically, you use All Identities in a policy while also configuring an advanced option, such as a particular user agent or destination (using a custom URL category). This allows you to create a single rule that makes an exception for a specific case instead of creating multiple rules to make the exception for the specific case. For example, you can create an Access Policy group whose membership applies to All Identities and a custom URL category for all intranet pages. Then you can configure the Access Policy control settings to disable anti-malware filtering and Web Reputation scoring.

Policy Group Membership Rules and Guidelines

Consider the following rules and guidelines when defining policy group membership:

- The Web Proxy evaluates Identity groups before the other policy types.
- Subnet membership criteria defined in the Identity group can be further narrowed down in the policy group using the Identity group.
- Advanced membership criteria (proxy ports, URL categories, and user agents) defined in the Identity group cannot be defined in the policy group using the Identity group.
- Define Identity groups as broadly as possible. Then you can use the Identity groups in other policy types and further narrow down membership as necessary.
- Define fewer, more generic Decryption and Routing Policies as much as possible.
- If you need to define membership by URL category, only define it in the Identity group when you need to exempt from authentication requests to that category. For other purposes, define membership by URL category in the Access, Decryption, Routing, Data Security, or External DLP Policy group. This can increase performance in most cases.

WORKING WITH TIME BASED POLICIES

The Web Security appliance provides the means to create time based policies by specifying time ranges, such as business hours, and using those time ranges to define access to the web. You can define policy group membership based on time ranges, and you can specify actions for URL filtering based on time ranges.

You might want to use time ranges to accomplish the following tasks:

- You can block access to high bandwidth sites, such as streaming media, or distracting sites, such as games, during business hours.
- You can route transactions to a particular external proxy after midnight when the other proxies are being serviced.
- You can allow larger files to be downloaded on the weekends.

Define time ranges on the Web Security Manager > Time Ranges page. You can create time ranges to define concepts such as “business hours” or “weekend shift.” Then you can use the time ranges in the following locations:

- Policy group membership for a Routing, Access, or Decryption Policy.
- URL filtering settings for Access Policies.

When you define a time range, you can specify the day(s) of the week and the time of day. A transaction matches the time range when it occurs on one of the days specified and during the time specified. You can also define multiple combinations of day and time in a single time range. For example, you can define a time range that applies to transactions that occur on Monday through Friday from 08:00 to 17:00 or on Saturday from 09:00 to 13:00.

Policies and URL filtering actions can be defined inside or outside the defined time ranges.

Note — Because you can define time based policy group membership only for Routing, Access, and Decryption Policies, but not Identities, you cannot create time based policies that define when users must authenticate. Authentication requirements are defined in Identity groups, but time based policies are defined in other policy group types. (bug #41723)

Creating Time Ranges

To create a time range:

1. Go to Web Security Manager > Time Ranges.
2. Click **Add Time Range**.

The Add Time Range page appears.

Add Time Range

Time Range		
Time Range Name: <input type="text"/>		
Time Zone:		
<input checked="" type="radio"/> Use Time Zone Setting from Appliance <small>(see System Administration > Time Zone)</small>		
<input type="radio"/> Specify Time Zone for this Time Range:		
Region: <input type="text" value="GMT Offset"/>		
Country: <input type="text" value="GMT"/>		
Time Zone: <input type="text" value="GMT-08 (GMT-8)"/>		
Time Values		
<small>Add a row to define an additional combination of Day of Week and Time of Day to be part of this Time Range.</small>		
Day of Week ?	Time of Day ?	<input type="button" value="Add Row"/>
<input type="checkbox"/> Monday <input type="checkbox"/> Tuesday <input type="checkbox"/> Wednesday <input type="checkbox"/> Thursday <input type="checkbox"/> Friday <input type="checkbox"/> Saturday <input type="checkbox"/> Sunday Select all Clear all	<input checked="" type="radio"/> All Day <input type="radio"/> From: <input type="text"/> To: <input type="text"/>	<input type="button" value="X"/>
<small>Select at least one day of the week in each row.</small>		<small>HH:MM (24 hour format)</small>

3. In the Time Range Name field, enter a name to use for the time range. Each time range name must be unique.
4. In the Time Zone section, choose whether to use the time zone setting on the Web Security appliance or a different time zone setting you configure.
5. In the Time Values section, define at least one row that specifies the days of the week and time of day to include in this time range.
 - a. In the Day of the Week section, select at least one day.
 - b. In the Time of Day section, choose All Day or enter a time range in the day using the From and To fields.

Each time range includes the start time and excludes the end time. For example, entering 8:00 through 17:00 matches 8:00:00 through 16:59:59, but not 17:00:00.

Midnight must be specified as 00:00 for a start time, and as 24:00 for an end time.

Note — A transaction must occur on the day *and* in the time specified to match a row in the Time Values section. That means the Day of Week and Time of Day values have an “AND” relationship with each other within a single row.

6. Optionally, you can create additional time value rows by clicking **Add Row**.

Note — When a time range includes multiple time value rows, a transaction can occur within any of the defined time values to match the time range. That means that multiple time value rows in a single time range have an “OR” relationship with each other.

7. Submit and commit your changes.

WORKING WITH USER AGENT BASED POLICIES

The Web Security appliance provides the means to create policies to define access to the web by the client application (user agent), such as a web browser, making the client request. You can define policy group membership based on user agents, and you can specify control settings based on user agents.

You might want to specify user agents to accomplish the following tasks:

- You can exempt certain user agents from authentication. You might want to do this for client applications that cannot handle prompting users for authentication credentials. For more information about how to do this, see “Exempting User Agents from Authentication” on page 140.
- You can block access from particular user agents that you define.

You can configure user agents in the following locations:

- Policy group membership for all policy types, including Identities.
- Application control settings for Access Policies.

Note — When the appliance is deployed in transparent mode, user agent information is not available for Decryption Policies.

Configuring User Agents for Policy Group Membership

When you define policy group membership for any policy type, you can expand the Advanced section to define membership by additional criteria, such as user agent. When you click the User Agents link, the Membership by User Agent page appears allowing you to define membership by user agent.

Figure 7-3 on page 139 shows the Membership by User Agent page for an Identity policy group.

Figure 7-3 Defining Policy Group Membership by User Agent

Identity Policies: Policy "New Policy": Membership by User Agent

On this page, you can select as many user agents as desired. The web interface includes some of the more common user agents that you can select using a check box. You can also type a regular expression to define any user agent necessary.

For each user agent you select in the Common User Agents section, AsyncOS for Web creates a regular expression to define the user agent. However, if you select the All Versions option for each browser type, AsyncOS for Web creates a single regular expression that represents all versions of that browser instead an expression for each version. Creating one regular expression instead of multiple increases performance.

For example, when you select “Version 2.X” and “Version 1.X or earlier” for Firefox, AsyncOS for Web uses the following regular expressions:

```
Firefox/2
Firefox/1
```

However, when you select “All Versions” under Firefox, AsyncOS uses the following regular expression:

```
Firefox
```

Also, you can configure the policy group membership to either match the user agents you define, or matching all other user agents than the ones defined.

Exempting User Agents from Authentication

To exempt a user agent from authentication:

1. Create an Identity policy group with membership that is based on the user agent to exempt.

For more information about creating Identities, see “Creating Identities” on page 158.

2. Do not require authentication for the Identity policy group.
3. Place the Identity policy group above all other Identity policy groups that require authentication.
4. Submit and commit your changes.

TRACING POLICIES

The Web Security appliance web interface includes a tool that traces a particular client request and details how the Web Proxy processes the request. The Web Proxy evaluates the request against all committed Access, Decryption, and Routing Policies and calculates other attributes, such as the web reputation score.

The policy trace tool allows administrators to troubleshoot when end users ask questions about Web Proxy behavior. It simulates client requests as if they were made by the end users and describes Web Proxy behavior. It can be a powerful troubleshooting or debugging tool, especially if you have combined many of the advanced features available on the Web Security appliance.

When you use the policy trace tool, the Web Proxy does not record the requests in the access log or reporting database.

Note — The policy trace tool explicitly makes requests even if the Web Security appliance is deployed in transparent mode.

You can trace policies on the System Administration > Policy Trace page.

To trace policies:

1. Navigate to the System Administration > Policy Trace page.

Policy Trace

Destination	
URL:	<input type="text"/>
Transaction	
<i>All fields below are optional.</i>	
Client IP Address:	<input type="text"/>
User:	<p><i>To represent an authenticated user, enter a User Name and select an Authentication Realm. If you are using policies based on authentication groups, select Get Groups to display a list of the groups associated with this user. Alternatively, you may manually enter the group names.</i></p> <p>User Name: <input type="text"/></p> <p>Authentication Realm: <input type="text" value="Select Realm..."/> <input type="button" value="Get Groups"/></p> <p>Authorized Groups: <input type="text"/></p>
<p>▸ Advanced <input type="button" value="Find Policy Match"/></p>	
Results	
<div style="border: 1px solid black; height: 100px;"></div>	

2. In the URL field, enter the URL in the client request to simulate.
3. Optionally, in the Client IP Address field, enter the IP address of the machine to simulate.

Note — If no IP address is specified, AsyncOS uses localhost.
4. Optionally, you can simulate an authentication user by entering the following authentication requirements in the User area:
 - **User Name.** Enter the user name of the authentication user.
 - **Authentication Realm.** Choose an authentication realm.
 - **Authorized Groups.** If any of the policies use authentication groups, you can click **Get Groups** to get a list of all authentication groups this user is a member of on the selected realm from which to select.

Note — For the authentication to work for the user you enter here, the user must have already successfully authenticated through the Web Security appliance.
5. Optionally, by expanding the Advanced section, you can configure additional settings to simulate a more specific user request that you want to trace.

Figure 7-4 shows the expanded Advanced section.

Figure 7-4 Policy Trace Feature Advanced Section

Advanced	
Request Details	
Forward Connection Port:	<input type="text"/>
User Agent:	<input type="text"/>
Time of Request:	Date: <input type="text"/> Time: <input type="text"/> (GMT +0800)
Response Detail Overrides	
URL Category:	<input type="text" value="Do not override category"/>
Object Size:	<input type="text"/> <small>(Add a trailing K, M, or G to indicate size unit)</small>
MIME Type:	<input type="text"/> Object and MIME Type Reference
Web Reputation Score:	<input type="text"/> <small>(from -10.0 to 10.0)</small>
Malware Verdict:	Webroot Verdict: <input type="text" value="Do not override malware verdict"/> McAfee Verdict: <input type="text" value="Do not override malware verdict"/>
<input type="button" value="Find Policy Match"/>	

The Advanced settings are divided into details of the transaction request to simulate and transaction response details to override.

- Configure the transaction request information to simulate as desired. Table 7-1 describes the request side advanced settings you can configure.

Table 7-1 Policy Trace Advanced Settings for Requests

Setting	Description
Forward Connection Port	Select a specific proxy port to use for the trace request to test policy group membership based on proxy port.
User Agent	Specify the user agent to simulate in the request.
Time of Request	Specify the day of week and time of day to simulate in the request.

- Configure the transaction response details to override as desired.

You might want to override a transaction response detail to simulate how a different response value, such as a lower web reputation score, would affect the policies assigned to the transaction. Table 7-2 describes the response side advanced settings you can configure.

Table 7-2 Policy Trace Advanced Settings for Response Overrides

Setting	Description
URL Category	Choose whether or not to override the URL category of the transaction response.
Object Size	Enter the size of the response object in bytes. You can enter K, M, or G to represent Kilobytes, Megabytes, or Gigabytes.
MIME Type	Enter the MIME type.
Web Reputation Score	Enter the web reputation score from -10.0 to 10.0.
Malware Verdict	Choose whether or not to override the Webroot or McAfee scanning verdicts.

- Click **Find Policy Match**.

The policy trace tool displays the results in the Results area.

Note — The **Find Policy Match** button turns into a **Cancel** button while the policy trace processes the parameters you enter. You can cancel the trace at any time.

Figure 7-5 on page 144 shows the Policy Trace page with some results from a policy trace.

Figure 7-5 Policy Trace Results

Policy Trace

Destination	
URL:	<input type="text" value="www.cnn.com"/>
Transaction	
<i>All fields below are optional.</i>	
Client IP Address:	<input type="text"/>
User:	<p><i>To represent an authenticated user, enter a User Name and select an Authentication Realm. If you are using policies based on authentication groups, select Get Groups to display a list of the groups associated with this user. Alternatively, you may manually enter the group names.</i></p> <p>User Name: <input type="text"/></p> <p>Authentication Realm: <input type="text" value="Select Realm..."/> <input type="button" value="Get Groups"/></p> <p>Authorized Groups: <input type="text"/></p>
<p>▸ Advanced <input type="button" value="Find Policy Match"/></p>	
Results	
<p>URL Check URL Category: News WBRS Score: 6.0 Object Size: 92881 bytes MIME-Type: text/html</p> <p>Policy Match Decryption policy: None Routing policy: Global Routing Policy Access policy: Global Access Policy</p> <p>Final Result Request completed Details: Request allowed by Web Reputation score Trace session complete</p>	

Identities

This chapter contains the following information:

- “Identities Overview” on page 146
- “Evaluating Identity Group Membership” on page 147
- “Matching Client Requests to Identity Groups” on page 152
- “Allowing Guest Access to Users Who Fail Authentication” on page 155
- “Creating Identities” on page 158
- “Configuring Identities in Other Policy Groups” on page 162
- “Example Identity Policies Tables” on page 165

IDENTITIES OVERVIEW

To control web traffic on the network and protect your network from web based threats, the Web Proxy needs to identify who is trying to access the web. Users can be identified by different criteria, such as their machine address or authenticated user name. The Web Proxy can apply different actions to transactions based on who is submitting the request.

To identify who is accessing the web, you create Identities in the Web Security appliance. An Identity is a policy that identifies and groups users. An Identity addresses the question, “who are you?”

Identities are the only policy where you define whether or not authentication is required to access the web. However, Identities do *not* specify a list of users who are *authorized* (allowed) to access the web. You specify authorized users in the other (non-Identity) policy types.

All other policy types use an Identity as the basis to determine which policy group applies to the transaction. That means you can create a single Identity and use it multiple times in the non-Identity policy groups.

You might want to group the following types of users or machines:

- **A group of machine addresses in a test lab.** You can create a Routing Policy with this Identity so requests from these machines are fetched directly from the destination server.
- **All authenticated users based on the All Realms authentication sequence.** You can create a single Access Policy using this Identity, or you can create a different Access Policy for each authentication realm and configure different control settings for users in each realm.
- **Users accessing the Web Security appliance on a particular proxy port.** You can create a Routing Policy using this Identity that fetches content from a particular external proxy for requests that explicitly connect to the appliance on a particular proxy port.
- **All subnets trying to access a website in a user defined URL category do not require authentication.** You can create an Access Policy using this Identity to exempt requests to particular destinations from authentication. You might want to do this for Windows update servers.

Define Identities on the Web Security Manager > Identities page. For more information about creating Identities, see “Creating Identities” on page 158.

EVALUATING IDENTITY GROUP MEMBERSHIP

When a client sends a request to a server, the Web Proxy receives the request, evaluates it, and determines to which Identity group it belongs.

To determine the Identity group that a client request matches, the Web Proxy follows a very specific process for matching the Identity group membership criteria. During this process, it considers the following factors for group membership:

- **Subnet.** The client subnet must match the list of subnets in a policy group.
- **Protocol.** The protocol used in the transaction, either HTTP/HTTPS or native FTP.
- **Port.** The proxy port of the request must be in the Identity group's list of ports, if any are listed. For explicit forward connections, this is the port configured in the browser. For transparent connections, this is the same as the destination port.

You might want to define Identity group membership on the proxy port if you have one set of clients configured to explicitly forward requests on one port, and another set of clients configured to explicitly forward requests on a different port.

Note — IronPort recommends only defining Identity group membership by the proxy port when the appliance is deployed in explicit forward mode, or when clients explicitly forward requests to the appliance. When you define Identity group membership by the proxy port when clients requests get transparently redirected to the appliance, some requests might be erroneously denied.

- **User agent.** The user agent making the request must be in the Identity group's list of user agents, if any are listed. You might want to group by user agent for user agents that cannot handle authentication and you want to create an Identity that does not require authentication.
- **URL category.** The URL category of the request URL must be in the Identity group's list of URL categories, if any are listed. You might want to group by URL destination category if you create different authentication groups based on URL categories and want to apply them to users depending on the website categorization.
- **Authentication requirements.** If the Identity group requires authentication, the client authentication credentials must match the Identity group's authentication requirements. For more information about how authentication works with Identity groups, see "How Authentication Affects Identity Groups" on page 148.

The information in this section gives an overview of how the appliance matches client requests to Identity groups. For more details on exactly how the appliance matches client requests, see "Matching Client Requests to Identity Groups" on page 152.

The Web Proxy sequentially reads through each Identity group in the Identity policies table. It compares the client request status to the membership criteria of the first Identity group. If they match, the Web Proxy assigns the Identity group to the transaction.

If they do not match, the Web Proxy compares the client request to the next Identity group. It continues this process until it matches the client request to a user defined Identity group, or if it does not match a user defined Identity group, it matches the global Identity policy. When the Web Proxy matches the client request to an Identity group or the global Identity policy, it assigns the Identity group to the transaction.

If at any time during the comparison process the user fails authentication, the Web Proxy terminates the request. For more information about how authentication works with Identity groups, see “How Authentication Affects Identity Groups” on page 148.

After the Web Proxy assigns an Identity to a client request, it evaluates the request against the other policy group types. For more information, see the following locations:

- “Evaluating Access Policy Group Membership” on page 172
- “Evaluating Decryption Policy Group Membership” on page 221
- “Evaluating Routing Policy Group Membership” on page 193
- “Evaluating Data Security and External DLP Policy Group Membership” on page 239

How Authentication Affects Identity Groups

Requiring authentication for users can help your organization control access to the web for groups of users. AsyncOS allows you to create multiple Identity groups and define the membership criteria based on authentication requirements.

When authentication is required for an Identity group, a gold key icon appears next to the Identity group name in the Policies table, as shown in Figure 8-1.

Figure 8-1 Identity Groups that Require Authentication

Identities

Client / Transaction Identity Definitions			
Add Identity...			
Order	Membership Definition	End-User Acknowledgement	Delete
1	3rdFloor Subnets: 10.1.1.2 Exempt from authentication	(global policy)	
2	LabTest Subnets: 10.1.1.1 Exempt from authentication	(global policy)	
3	LDAPUsers Authentication: Realm: ldap (Scheme: Basic)	(global policy)	
4	NTLMUsers Authentication: Realm: ntlm (Scheme: NTLMSSP)	(global policy)	
Global Identity Policy Exempt from authentication		Not Available	

Authentication: Enabled Disabled Policy Disabled

To define authentication requirements for an Identity group, you can choose an authentication realm or sequence that applies to the Identity group.

Note — You can specify the authorized users when you use the Identity in a non-Identity policy group.

Consider the following rules and guidelines when creating and ordering Identity groups:

- **Identity group order.** All Identity groups that do not require authentication must be above Identity groups that require authentication.
- **Cookie-based authentication.** When the appliance is configured to use cookie-based authentication surrogates, it does not get cookie information from clients for HTTPS and FTP over HTTP requests. Therefore, it cannot get the user name from the cookie. How HTTPS and FTP over HTTP requests are matched against the Identity groups varies based on other factors. For more information, see “How Authentication Affects HTTPS and FTP over HTTP Requests” on page 149.
- **Identity uniqueness.** Verify the Identity group membership requirements are unique for each Identity group. If two Identity groups require the exact same membership, then client requests never match the lower Identity group. If any non-Identity policy uses the lower Identity group, client requests never match that policy.
- **Global Identity policy.** The global Identity policy does not require authentication by default when you create an authentication realm. If you want the global Identity policy to require authentication, you must assign an authentication realm, authentication sequence, or the All Realms sequence to the global Identity policy.

For some examples of how the Web Proxy matches client requests to an Identity group for different Identity policies tables, see “Example Identity Policies Tables” on page 165.

How Authentication Affects HTTPS and FTP over HTTP Requests

How the Web Proxy matches HTTPS and FTP over HTTP requests with Identities depends on the type of request (either explicitly forwarded or transparently redirected to the Web Proxy) and the authentication surrogate type:

- **No authentication surrogates.** The Web Proxy matches HTTPS and FTP over HTTP requests with Identity groups the same way it matches HTTP requests. For a diagram of how this occurs, see Figure 8-2 on page 153.
- **IP-based authentication surrogates and explicit requests.** The Web Proxy matches HTTPS and FTP over HTTP requests with Identity groups the same way it matches HTTP requests. For a diagram of how this occurs, see Figure 8-2 on page 153.
- **IP-based authentication surrogates and transparent requests.** The Web Proxy matches FTP over HTTP requests with Identity groups the same way it matches HTTP requests. But for HTTPS requests, the behavior is different, depending on whether or not the HTTPS request comes from a client that has authentication information available from an earlier HTTP request:
 - **Information available from a previous HTTP request.** The Web Proxy matches HTTPS requests with Identity groups the same way it matches HTTP requests. For a diagram of how this occurs, see Figure 8-2 on page 153. HTTPS requests are treated with the Identity associated with the IP address.

- **No information available from a previous HTTP request.** When the Web Proxy has no credential information for the client, then it fails the HTTPS request.
- **Cookie-based authentication surrogates and transparent requests.** When the appliance uses cookie-based authentication, the Web Proxy does not get cookie information from clients for HTTPS and FTP over HTTP requests. Therefore, it cannot get the user name from the cookie. In this situation, HTTPS and FTP over HTTP requests still match the Identity group according to the other membership criteria, but the Web Proxy does not prompt clients for authentication *even if the Identity group requires authentication*. Instead, the Web Proxy sets the user name to NULL and considers the user as *unauthenticated*. Then, when the unauthenticated request is evaluated against the non-Identity policy groups, it only matches non-Identity groups that specify “All Identities” and apply to “All Users.” Typically, this is the global policy, such as the global Access Policy. For a diagram of how this occurs, see Figure 8-3 on page 154.
- **Cookie-based authentication surrogates and explicit requests.** The behavior is different, depending on whether or not credential encryption is enabled:
 - **Credential encryption enabled.** The behavior is the same as cookie-based authentication with transparent requests, as described above.
 - **Credential encryption disabled.** The Web Proxy uses no surrogates and HTTPS and FTP over HTTP requests are authenticated and matched to Identity groups like HTTP requests. For a diagram of how this occurs, see Figure 8-2 on page 153.

Table 8-1 summarizes the information described above.

Table 8-1 Matching HTTPS and FTP over HTTP Requests to Identities

Surrogate Types	Explicit Requests	Transparent Requests
No Surrogate	HTTPS and FTP over HTTP requests are matched like HTTP requests.	N/A
IP-based	HTTPS and FTP over HTTP requests are matched like HTTP requests.	FTP over HTTP requests are matched like HTTP requests. HTTPS requests are matched like HTTP requests only if a previous HTTP request was authenticated, otherwise, the request fails.
Cookie-based	Client is not prompted for authentication. Note: When credential encryption is disabled, no surrogates are used and HTTPS requests are matched like HTTP requests	Client is not prompted for authentication.

How Authentication Scheme Affects Identity Groups

You define the authentication scheme for each Identity group, not at each realm or sequence. That means you can use the same NTLM realm or a sequence that contains an NTLM realm and use it in Identity groups that use either the NTLMSSP, Basic, or “Basic or NTLMSSP” authentication schemes.

The Web Proxy communicates which scheme(s) it supports to the client application at the beginning of a transaction. The Identity group currently in use determines which scheme(s) it supports. When the Web Proxy informs the client application that it supports both Basic and NTLMSSP, the client application chooses which scheme to use in the transaction.

Some client applications, such as Internet Explorer, always choose NTLMSSP when given a choice between NTLMSSP and Basic. This might cause a user to not pass authentication when all of the following conditions are true:

- The Identity group uses a sequence that contains both LDAP and NTLM realms.
- The Identity group uses the “Basic or NTLMSSP” authentication scheme.
- A user sends a request from an application that chooses NTLMSSP over Basic.
- The user only exists in the LDAP realm.

When this happens, the Web Proxy uses the NTLMSSP scheme to authenticate users in this Identity group because the client requests it. However, LDAP servers do not support NTLMSSP, so no user that exists only in the specified LDAP server(s) can pass authentication in this Identity group.

Therefore, when you need to use an authentication sequence that contains both LDAP and NTLM realms, consider the client applications that might try to access a URL when you configure the authentication scheme for an Identity group. For example, you might want to choose Basic as the only authentication scheme for an Identity group in some cases.

MATCHING CLIENT REQUESTS TO IDENTITY GROUPS

Figure 8-2 on page 153 shows how the Web Proxy evaluates a client request against the Identity groups when the Web Security appliance is configured to use:

- No authentication surrogates
- IP addresses as authentication surrogates
- Cookies as authentication surrogates with transparent requests
- Cookies as authentication surrogates with explicit requests and credential encryption is enabled

Figure 8-3 on page 154 shows how the Web Proxy evaluates a client request against the Identity groups when the Web Security appliance is configured to use cookies as the authentication surrogates, credential encryption is enabled, and the request is explicitly forwarded.

Figure 8-2 Policy Group Flow Diagram for Identities - No Surrogates and IP-Based Surrogates

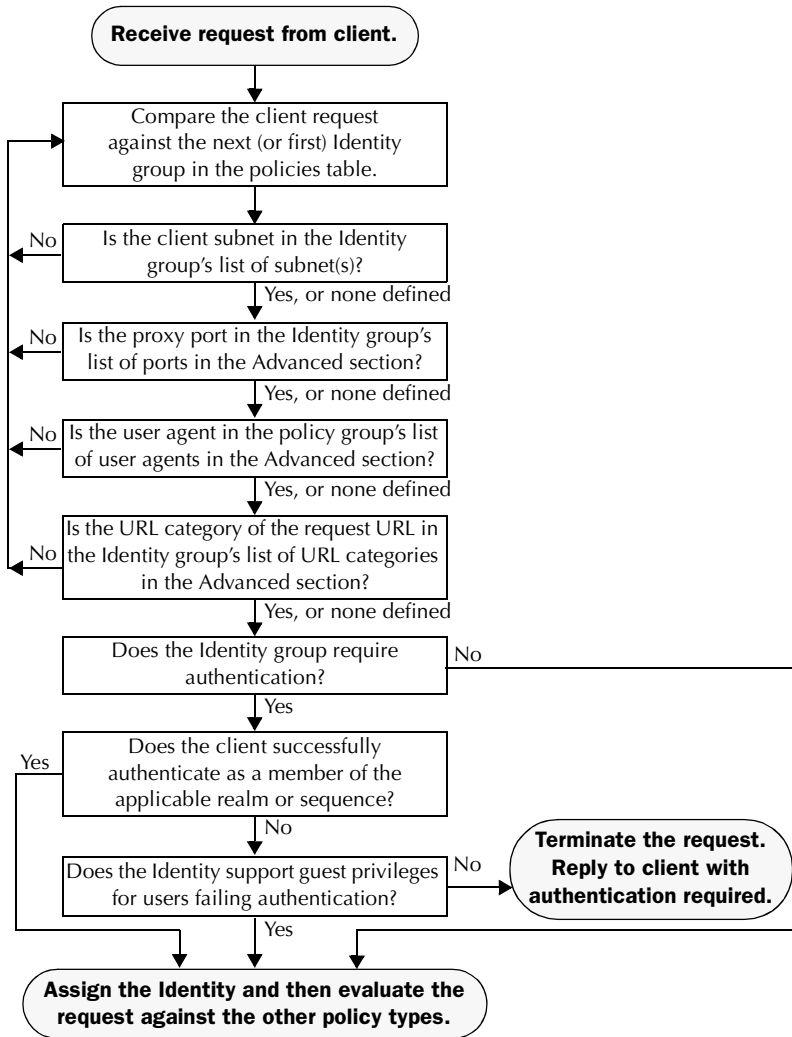
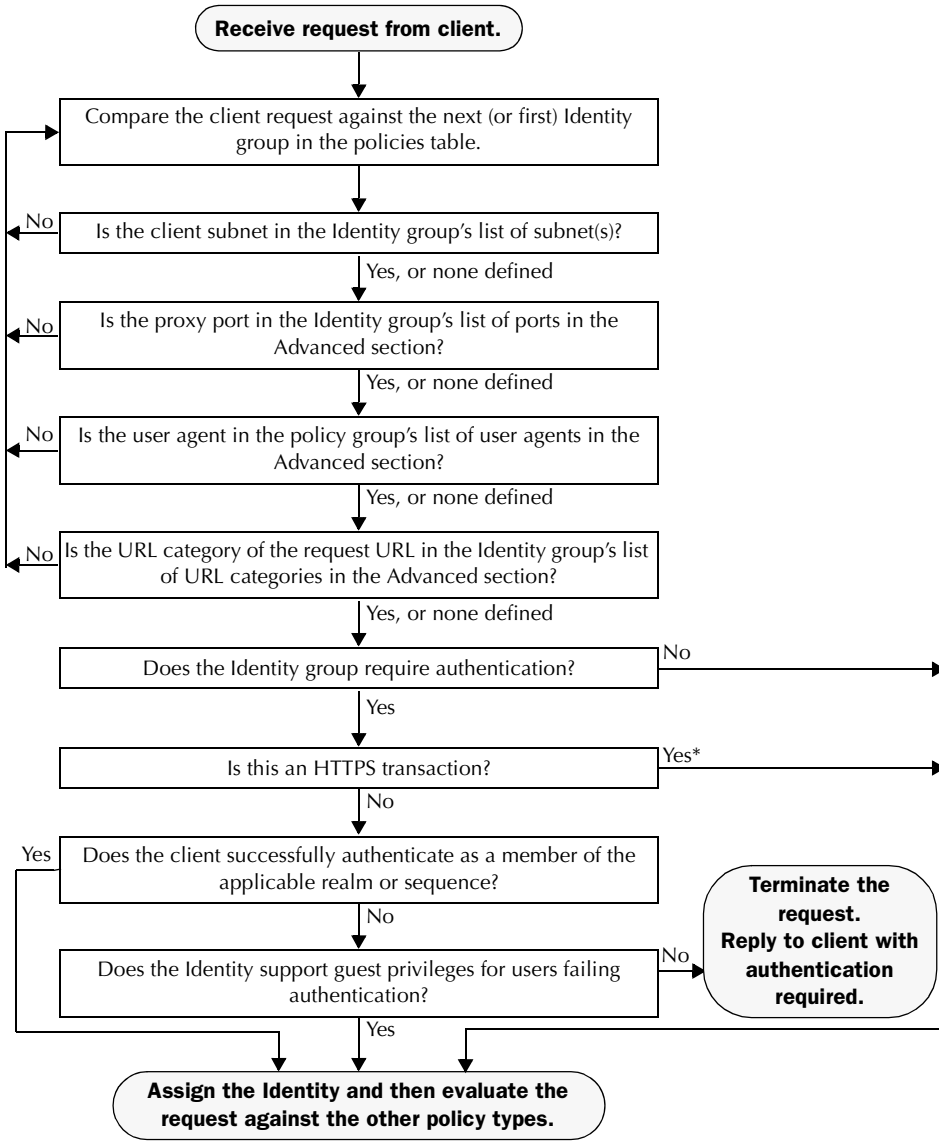

Figure 8-3 Policy Group Flow Diagram for Identities - Cookie-Based Surrogates



*In this scenario, the Web Proxy sets the user name to NULL. For more information, see "How Authentication Affects HTTPS and FTP over HTTP Requests" on

ALLOWING GUEST ACCESS TO USERS WHO FAIL AUTHENTICATION

You can grant limited access to users who fail authentication due to invalid credentials. By default, when a client passes invalid authentication credentials, the Web Proxy continually requests valid credentials, essentially blocking access to all Internet resources. However, when you allow guest access, the first time the client passes invalid authentication credentials, the user is treated as a guest and the Web Proxy does not request authentication again.

You might want to grant guest access to users in the following situations:

- A visitor comes to the office and needs to be granted restrictive Internet access, but is not in the corporate user directory.
- An employee from another branch location (or from an acquired company) comes to the corporate headquarters, and needs Internet access. The user directories of the branch location (or acquired company) and corporate headquarters are separate, so the employee's credentials do not work in the corporate headquarters.
- A new hire has been provided credentials in an email but they are not yet populated in the authentication server.
- A user logs into a Windows workstation using a local account instead of a Windows domain account and the user needs access to the Internet.

The authentication server administrator in your organization can create a guest user account in the user directory. However, allowing guest access through the Web Security appliance has the benefit that the administrator does not have to communicate the guest credentials to every visitor.

To grant guest access to users who fail authentication, you create an Identity that requires authentication, but also allows guest privileges. Then you create another policy using that Identity and apply that policy to the guest users. When users who fail authentication have guest access, they can access the resources defined in the policy group that specifies guest access for that Identity.

A user who fails authentication has all transactions *blocked* if *either* of the following conditions are true:

- Guest privileges are not provided in any Identity.
- The user does not match any Identity that provides guest privileges.

A user who fails authentication has transactions *allowed* when *all* of the following conditions are true:

- The user matches an Identity with guest privileges.
- A non-Identity policy group uses that Identity and applies to guest users.

For example, you can create an Access or Decryption Policy that is specific to guest users.

Note — If an Identity allows guest access and there is no user defined policy group that uses that Identity, users who fail authentication match the global policy for that policy type. For example, if MyIdentity allows guest access and there is no user defined Access Policy that uses MyIdentity, users who fail authentication match the global Access Policy. If you do not want guest users to match a global policy, create a policy group above the global policy that applies to guest users and blocks all access.

When the Web Proxy grants a user guest access, it identifies and logs the user as a guest in the access logs. You can specify whether the Web Proxy identifies the user by IP address or user name. In the access logs, reports, and end-user acknowledgement page, entries for guest users have one of the following formats:

- (unauthenticated)IP_address
- (unauthenticated)username_entered

You can enable guest access for an Identity that uses any authentication protocol or scheme.

To grant guest access to a user:

1. Define an Identity group and enable the “Support Guest privileges for users failing authentication” option.

Membership Definition
Membership is defined by any combination of the following options. All criteria must be met for the policy to take effect.

Define Members by Subnet: [Empty text box]
(examples: 10.1.1.1, 10.1.1.0/24, 10.1.1.1-10)

Define Members by Protocol:

- All protocols
- HTTP/HTTPS Only (?)
- Native FTP Only

Define Members by Authentication:

- No Authentication
This option may not be valid if any preceding Identity requires authentication on all subnets.
- Request Authentication

NTLMRealm: [Dropdown] Scheme: [Use NTLMSSP] (dropdown)
Scheme setting applies to HTTP/HTTPS only.

Support Guest privileges for users failing authentication (?)
Authorization of specific users and groups is defined in subsequent policy layers (see Web Security Manager > Decryption Policies, Routing Policies and Access Policies).

Advanced Define additional group membership criteria.

— This Identity allows guest access.

2. Create an Access, Decryption, Routing, Data Security, or External DLP Policy and select the Identity created in step 1.
3. In the Access, Decryption, Routing, Data Security, or External DLP Policy group membership, select “Guests (users failing authentication)” for the Identity in step 1.

Policy Member Definition

Membership is defined by the combination of the following options. All criteria must be met for the policy to take effect.

Identities and Users: Select One or More Identities

Identity	Authorized Users and Groups	Add Identity
NTLMUsers	<input type="radio"/> All Authenticated Users <input type="radio"/> Selected Groups and Users Groups: No groups entered Users: No users entered <input checked="" type="radio"/> Guests (users failing authentication)	

[Advanced](#) *Define additional group membership criteria.*

Guests of this Identity are authorized to access the web.

4. Submit and commit your changes.

Note — You can configure the Web Proxy to request authentication again if an authenticated user is blocked from a website due to restrictive URL filtering. To do this, enable the “Enable Re-Authentication Prompt If End User Blocked by URL Category” global authentication setting. For more information, see “Allowing Users to Re-Authenticate” on page 386.

CREATING IDENTITIES

You can create Identities based on combinations of several criteria, such as client subnet or the URL category of the destination site. You must define at least one criterion for Identity membership. When you define multiple criteria, the client request must meet all criteria to match the Identity.

For more information about how the Web Proxy matches a client request with an Identity, see “Evaluating Identity Group Membership” on page 147 and “Matching Client Requests to Identity Groups” on page 152.

You define Identity group membership on the Web Security Manager > Identities page.

Note — If you delete an authentication realm or sequence, any Identity that depends on the deleted realm or sequence becomes disabled.

To create an Identity group:

1. Navigate to the Web Security Manager > Identities page.
2. Click **Add Identity**.

Identities: Add Identity

Identity Settings	
<input checked="" type="checkbox"/> Enable Identity	
Name: ?	<input type="text" value=""/> <small>(e.g. my IT policy)</small>
Description:	<input type="text"/>
Insert Above:	1 (TestLab) ▾

Membership Definition	
<i>Membership is defined by any combination of the following options. All criteria must be met for the policy to take effect.</i>	
Define Members by Subnet:	<input type="text"/> <small>(examples: 10.1.1.1, 10.1.1.0/24, 10.1.1.1-10)</small>
Define Members by Protocol:	<input checked="" type="radio"/> All protocols <input type="radio"/> HTTP/HTTPS Only ? <input type="radio"/> Native FTP Only
Define Members by Authentication:	<input checked="" type="radio"/> No Authentication <small>This option may not be valid if any preceding Identity requires authentication on all subnets.</small> <input type="radio"/> Request Authentication <input type="text" value="LDAPRealm"/> ▾ <input type="checkbox"/> Support Guest privileges for users failing authentication ? <small>Authorization of specific users and groups is defined in subsequent policy layers (see Web Security Manager > Decryption Policies, Routing Policies and Access Policies).</small>
Advanced Define additional group membership criteria.	

3. In the Name field, enter a name for the Identity group, and in the Description field, optionally add a description.

Note — Each Identity group name must be unique.

4. In the Insert Above field, choose where in the policies table to place the Identity group.

When configuring multiple Identity groups, you must specify a logical order for each group. Carefully order your Identity groups to ensure that correct matching occurs and position groups that do not require authentication above the first policy group that does require authentication. For more information about how authentication affects Identity groups, see “How Authentication Affects Identity Groups” on page 148.

5. In the Define Members by Subnet field, enter the addresses to which this Identity should apply.

You can enter IP addresses, CIDR blocks, and subnets. Separate multiple addresses with commas.

Note — If you do not enter an address in this field, the Identity group applies to *all* IP addresses. For example, if you configure the Identity to require authentication, but do not define any other settings, then the Identity acts similarly to the Default Identity Policy with authentication required.

6. In the Define Members by Protocol section, choose to which protocols this Identity should apply:

- **All protocols.** This option applies to all protocols the Web Security appliance supports.
- **HTTP/HTTPS only.** This option applies to all requests that use HTTP or HTTPS as the underlying protocol, including FTP over HTTP and any other protocol tunneled using HTTP CONNECT.
- **Native FTP only.** This option applies to native FTP requests only.

Note — To match transparently redirected HTTPS transactions, the Identity must specify “All protocols” instead of “HTTP/HTTPS.”

7. In the Define Members by Authentication section, choose whether or not this Identity requires authentication. You can choose No Authentication Required or you can choose a defined authentication realm or sequence.

8. If you choose an NTLM authentication realm or sequence that contains an NTLM authentication realm, you can choose the authentication scheme in the Scheme field.

Note — You can specify individual authenticated users or groups of users when you use the Identity in a different type of policy group. For more information, see “Configuring Identities in Other Policy Groups” on page 162.

9. If this Identity requires authentication, you can grant access to users who fail authentication due to invalid credentials.

For more information, see “Allowing Guest Access to Users Who Fail Authentication” on page 155.

- Optionally, expand the Advanced section to define additional membership requirements.

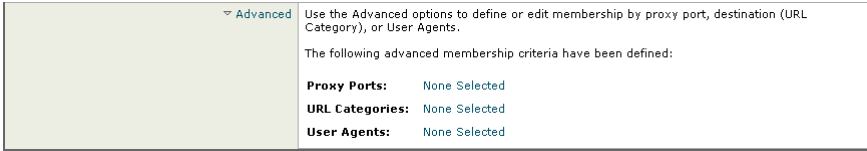

- To define Identity group membership by any of the advanced options, click the link for the advanced option and configure the option on the page that appears.

Table 8-2 describes the advanced options you can configure for Identity groups.

Table 8-2 Identity Group Advanced Options

Advanced Option	Description
Proxy Ports	<p>To define policy group membership by the proxy port used to access the Web Proxy, enter one or more port numbers in the Proxy Ports field. Separate multiple ports with commas.</p> <p>For explicit forward connections, this is the port configured in the browser. For transparent connections, this is the same as the destination port. You might want to define policy group membership on the proxy port if you have one set of clients configured to explicitly forward requests on one port, and another set of clients configured to explicitly forward requests on a different port.</p> <p>Note: IronPort recommends only defining policy group membership by the proxy port when the appliance is deployed in explicit forward mode, or when clients explicitly forward requests to the appliance. When you define policy group membership by the proxy port when clients requests get transparently redirected to the appliance, some requests might be denied.</p>
URL Categories	<p>Choose the user defined or predefined URL categories. Membership for both user defined and predefined URL categories are excluded by default, meaning the Web Proxy ignores all categories unless they are selected in the Add column.</p>

Table 8-2 Identity Group Advanced Options (Continued)

Advanced Option	Description
User Agents	<p>Choose whether or not to define policy group membership by the user agent used in the client request. You can select some commonly defined browsers, or define your own using regular expressions. Choose whether this policy group should apply to the selected user agents or to any user agent that is not in the list of selected user agents.</p> <p>For more information on creating user agent based policies, see “Working with User Agent Based Policies” on page 138.</p>

12. Submit and commit your changes.

CONFIGURING IDENTITIES IN OTHER POLICY GROUPS

Every non-Identity policy group specifies at least one Identity group as part of its policy group membership. You can configure a non-Identity policy group to use multiple Identity groups, and you can specify which users or groups of users are authorized to access the web using the policy group.

You might want to specify multiple Identity groups in a policy group under the following circumstances:

- You have an Identity group defined for HTTP transactions and another Identity group defined for native FTP transactions. You can create a single non-Identity policy group that applies to both HTTP and native FTP transactions
- Separate Identity groups are defined for each authentication realm. You want to create one Access Policy group that defines the same access control settings for users in multiple authentication realms.

Note — You can also specify All Identities and configure the authenticated users.

Figure 8-4 shows a policy group that uses multiple Identities.

Figure 8-4 Multiple Identities in a Policy Group

Policy Member Definition
Membership is defined by the combination of the following options. All criteria must be met for the policy to take effect.

Identities and Users:	Select One or More Identities	Authorized Users and Groups	Add Identity
	AllAuthenticatedUsers	<input checked="" type="radio"/> All Authenticated Users Realm: NTLMRealm <input type="radio"/> Selected Groups and Users Groups: No groups entered Users: No users entered <input type="radio"/> Guests (users failing authentication)	🗑️
	SatelliteOffice	<input checked="" type="radio"/> All Authenticated Users <input type="radio"/> Selected Groups and Users Groups: No groups entered Users: No users entered <input type="radio"/> Guests (users failing authentication)	🗑️
	LDAPUsers	<input type="radio"/> All Authenticated Users <input checked="" type="radio"/> Selected Groups and Users Groups: eng qa Users: No users entered	🗑️

The specified user groups in this Identity are authorized for this policy group.

All authenticated users in this Identity are authorized for this policy group.

This Identity uses an authentication sequence and this policy group applies to one realm in the sequence.

Note — If an Identity group becomes disabled, then that Identity group is *removed* (not disabled) from any non-Identity policy group that used it. If the Identity group becomes enabled again, the non-Identity policy groups that previously used the Identity do not automatically include the enabled Identity. Identity groups become disabled due to a deleted authentication realm or sequence.

To configure Identity group information in a policy group:

1. Create a new policy group or edit the membership of an existing policy group for Access, Decryption, Routing, Data Security, or External DLP Policy.
2. Scroll down to the Identities and Users section.

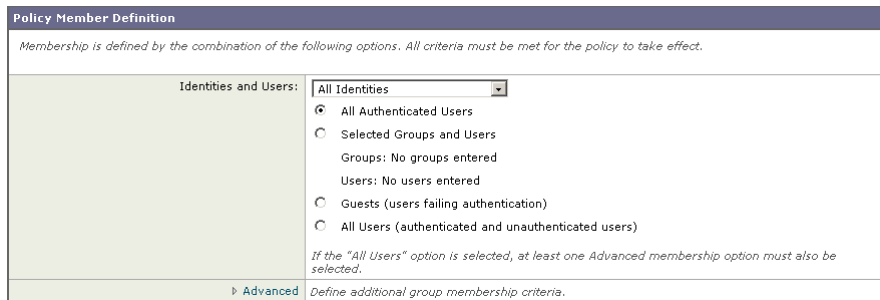

3. Choose one of the following options from the dropdown menu:
 - **Select One or More Identities.** This option allows you to configure specific Identity groups. Go to step 4.
 - **All Identities.** This option specifies all configured Identity groups. Go to step 5.
4. Under the Identity column, choose the Identity group to apply to this policy group.
5. If you choose an Identity that requires authentication, you can specify which users are authorized for this policy group. These users must authenticate. In the Authorized Users and Groups column, choose one of the following options:
 - **All authenticated users.** You can configure the Identity in this policy group to apply to all users in the Identity group by default. If the Identity group specifies an authentication sequence, you can configure this policy group to apply to one authentication realm or all realms in the sequence.
 - **Selected Groups and Users.** You can configure the Identity in this policy group to apply to specific users. You can define users by group object or user object. Click the link for either Groups or Users, and enter the group or user information on the page that opens.
When you add groups of users for an Identity using an NTLM authentication realm, the Edit Groups page displays the first 500 matching entries, omitting built-in groups.
 - **Guests (users failing authentication).** If the Identity group allows guest access, you can configure this policy group to apply to all users who fail to authenticate in this

Identity. For more information, see “Allowing Guest Access to Users Who Fail Authentication” on page 155.

- **All users (authenticated and unauthenticated users).** You can configure this policy group to apply to every user in every Identity group. This option only appears when you choose All Identities. When you apply the policy group to all users, you must specify at least one advanced option to distinguish this policy group from the global policy.
6. Optionally, if you configured specific Identity groups, you can add another Identity group to this policy group by clicking **Add Identity**.
 7. If you add another Identity group, repeat steps 4 through 5.
 8. Submit and commit your changes.

EXAMPLE IDENTITY POLICIES TABLES

This section shows some sample Identity groups defined in an Identity policies table and describes how the Web Proxy evaluates different client requests using each Identity policies table.

Example 1

Table 8-3 shows an Identity policies table with three user defined Identity groups. The first Identity group applies to a particular subnet and does not require authentication. The second Identity group applies to all subnets and requests for URLs in the “Proxies & Translators” category, and requires authentication on RealmA. The third Identity group applies to all subnets, has no advanced options defined, and requires authentication on RealmA. The global Identity policy applies to all subnets (by definition) and does not require authentication.

Table 8-3 Policies Table Example 1

Order	Subnet(s)	Authentication Required?	Realm or Sequence	Advanced Options
1	10.1.1.1	No	N/A	none
2	All	Yes	RealmA	URL Category is “Proxies & Translators”
3	All	Yes	RealmA	none
Global Identity policy	All (by default)	No	N/A	N/A (none by default)

The Web Proxy matches client requests to Identity groups in this scenario differently, depending on the client’s subnet and the URL category of the request:

- **Any client on subnet 10.1.1.1 for any URL.** When a client on subnet 10.1.1.1 sends a request for any URL, the Web Proxy evaluates the first Identity group and determines that the client subnet matches the first Identity group subnet. Then it determines that no authentication is required and no advanced options are configured, so it assigns the first Identity group to the transaction.
- **Any client on a subnet other than 10.1.1.1 for URLs in the “Proxies & Translators” URL category.** When a client on a subnet other than 10.1.1.1 sends a request for a URL in the “Proxies & Translators” category, the Web Proxy evaluates the first Identity group and determines that the client subnet is not listed in the first Identity group’s list of subnets. Therefore, it evaluates the second Identity group, and then determines that the client subnet is listed in the second Identity group’s list of subnets. Then it determines that the URL in the request matches the URL category in the second Identity group’s advanced

section. Then it determines that the second Identity group requires authentication, so it tries to authenticate the user against the authentication server(s) defined in RealmA. If the user exists in RealmA, the Web Proxy assigns the second Identity group to the transaction. If the user does not exist in RealmA, AsyncOS terminates the client request because the client failed authentication.

- Any client on a subnet other than 10.1.1.1 for any URL *not* in the “Proxies & Translators” URL category.** When a client on a subnet other than 10.1.1.1 sends a request for a URL, the Web Proxy evaluates the first Identity group and determines that the client subnet is not listed in the first Identity group’s list of subnets. Therefore, it evaluates the second Identity group, and then determines that the client subnet is listed in the second Identity group’s list of subnets. Then it determines that the URL in the request *does not* match the URL category in the second Identity group’s advanced section. Therefore, it evaluates the third Identity group, and then determines that the client subnet is listed in the third Identity group’s list of subnets. The third Identity group does not have any advanced options configured, so continues to compare against authentication requirements. Then it determines that the third Identity group requires authentication, so it tries to authenticate the user against the authentication server(s) defined in RealmA. If the user exists in RealmA, the Web Proxy assigns the third Identity group to the transaction. If the user does not exist in RealmA, the Web Proxy terminates the client request because the client failed authentication.

Note that in this scenario, most client requests will never match the global Identity group because of the user defined Identity group (the third group) that applies to all subnets, has no advanced options, and requires authentication. Any client on the network that does not match the first or second Identity group will match the third Identity group. The exception to this is for HTTPS requests when the appliance is in transparent mode with cookie-based authentication. Any client on a subnet other than 10.1.1.1 will match the global Identity group even though it requires authentication.

Example 2

Table 8-4 shows a policies table with two user defined Identity groups. The first Identity group applies to all subnets, requires authentication, and specifies RealmA for authentication. The second Identity group applies to all subnets, requires authentication, and specifies RealmB for authentication. Neither Identity group has any advanced option configured. The global Identity group applies to all subnets, requires authentication, and specifies the All Realms sequence for authentication.

Table 8-4 Policies Table Example 2

Order	Subnet(s)	Authentication Required?	Realm or Sequence	Advanced Options
1	All	Yes	RealmA	none
2	All	Yes	RealmB	none

Table 8-4 Policies Table Example 2 (Continued)

Order	Subnet(s)	Authentication Required?	Realm or Sequence	Advanced Options
Global Identity policy	All	Yes	All Realms	N/A (none by default)

In this scenario, when a client sends a request for a URL, the Web Proxy evaluates the first Identity group and determines that the Identity group applies to all subnets and has no advanced options configured. It determines that the Identity group requires authentication and that the only realm specified in the Identity group is RealmA. Therefore, *in order for a client on any subnet to pass authentication, it must exist in RealmA.*

When a client that exists in RealmA sends a request for a URL, the client passes authentication and the Web Proxy assigns the first Identity group to the transaction. When a client that does *not* exist in RealmA sends a request for a URL, the client fails authentication and the Web Proxy terminates the request.

Note that when a client in RealmB sends a request for a URL, the Web Proxy does *not* match the client request with the second Identity group. This is because a previous Identity group already applies to the same subnets (and the exact same advanced options, which in this example is none) in the second Identity group and it requires authentication, but from RealmA instead. Clients in RealmB do not “fall through” to the second Identity group.

If you want users in RealmB to have different Access, Decryption, and Routing Policy settings applied to them than users in RealmA, perform the following steps:

1. Create an authentication sequence that contains both RealmA and RealmB. You can choose the order of the realms in the sequence depending on your business needs.
2. Create one Identity group and configure it for whichever subnets on which users in RealmA and RealmB might exist. In this example, you would configure the Identity group for all subnets.
3. Configure the Identity group to use the sequence you defined in step 1.
4. Create two user defined policy groups of the same type, such as Access Policies, and configure them both to use the Identity group with the authentication sequence you defined in step 3.
5. Configure the first policy group to only apply to users in one realm, such as RealmA. You can do this by specifying a particular realm in the sequence, or by using authentication groups, or entering specific usernames.
6. Configure the second policy group to only apply to users in the other realm, such as RealmB. You can do this by specifying a particular realm in the sequence, or by using authentication groups, or entering specific usernames.

When you configure the appliance in this way, any client that sends a request for a URL must exist in either realm in the sequence (RealmA or RealmB) in order to pass authentication at the Identity level. Once an Identity has been assigned to the client request, the Web Proxy can compare the client request against the other policy types and determine which policy group, such as an Access Policy group, to match and then apply those control settings. In this example, the Web Proxy matches users in RealmA with the policy group configured in step 5, and matches users in RealmB with the policy group configured in step 6.

Access Policies

This chapter contains the following information:

- “Access Policies Overview” on page 170
- “Evaluating Access Policy Group Membership” on page 172
- “Creating Access Policies” on page 174
- “Controlling HTTP and Native FTP Traffic” on page 177
- “Blocking Specific Applications and Protocols” on page 182

ACCESS POLICIES OVERVIEW

AsyncOS for Web uses multiple web security features in conjunction with its Web Proxy and DVS engine to control web traffic, protect networks from web-based threats, and enforce organization acceptable use policies. You can define policies that determine which HTTP connections are allowed and blocked.

To configure the appliance to handle HTTP requests, perform the following tasks:

1. **Enable the Web Proxy.** To allow or block HTTP traffic, you must first enable the Web Proxy. Usually, the Web Proxy is enabled during the initial setup using the System Setup Wizard. For more information, see “Configuring the Web Proxy” on page 88.
2. **Create and configure Access Policy groups.** After the Web Proxy is enabled, you create and configure Access Policy groups to determine how to handle each request from each user. For more information, see “Access Policy Groups” on page 170.

Access Policy Groups

Access Policies define how the Web Proxy handles HTTP GET requests and decrypted HTTPS connections for network users. You can apply different actions to specified groups of users. You can also specify which ports the Web Proxy monitors for HTTP transactions.

Note — HTTP PUT and POST requests are handled by IronPort Data Security and External DLP Policies. For more information, see “Data Security and External DLP Policies Overview” on page 234.

When the Web Proxy receives an HTTP request on a monitored port or a decrypted HTTPS connection, it compares the request to the Access Policy groups to determine which Access Policy group to apply. After it assigns the request to an Access Policy group, it can determine what to do with the request. For more information about evaluating policy group membership, see “Policy Group Membership” on page 133.

The Web Proxy can perform any of the following actions on an HTTP request or decrypted HTTPS connection:

- **Allow.** The Web Proxy permits the connection without interruption. Allowed connections may not have been scanned by the DVS engine.
- **Block.** The Web Proxy does not permit the connection and instead displays an end user notification page explaining the reason for the block.
- **Redirect.** The Web Proxy does not allow the connection to the originally requested destination server and instead connects to a different specified URL. You might want to redirect traffic at the appliance if your organization published the links to an internal site, but the location of the site changed since publication, or if you do not have control over the web server. For more information about redirecting traffic, see “Redirecting Traffic” on page 304.

Note — The preceding actions are final actions that the Web Proxy takes on a client request. The Monitor action that you can configure for Access Policies is not a final action. For more information, see “Understanding the Monitor Action” on page 171.

After the Web Proxy assigns an Access Policy group to an HTTP or decrypted HTTPS request, it compares the request to the policy group’s configured control settings to determine which action to apply. You can configure multiple security components to determine how to handle HTTP and decrypted HTTPS requests for a particular policy group. For more information about the security components that you can configure and how the Web Proxy uses Access Policy groups to control HTTP traffic, see “Controlling HTTP and Native FTP Traffic” on page 177.

Understanding the Monitor Action

When the Web Proxy compares a transaction to the control settings, it evaluates the settings in order. Each control setting can be configured to perform one of the following actions for Access Policies:

- Monitor
- Allow
- Block
- Redirect

All actions except Monitor are final actions that the Web Proxy applies to a transaction. A final action is an action that causes the Web Proxy to stop comparing the transaction to the rest of the control settings.

The Monitor action is an intermediary action. The Web Proxy continues comparing the transaction to the other control settings to determine which final action to apply.

For example, if an Access Policy is configured to *monitor* a suspect user agent, the Web Proxy does not make a final determination about a request from the user agent. If an Access Policy is configured to *block* a particular URL category, then any request to that URL category is blocked before fetching the content from the server regardless of the server’s reputation score.

Note — When a control setting matches Monitor and the transaction is ultimately allowed, the Web Proxy logs the monitored setting in the access logs. For example, when a URL matches a monitored URL category, the Web Proxy logs the URL category in the access logs.

Figure 9-3 on page 178 shows the order that the Web Proxy uses when evaluating control settings for Access Policies. The flow diagram shows that the only actions applied to a transaction are the final actions: Allow, Block, and Redirect.

Note — Figure 11-9 on page 229 shows the order the Web Proxy uses when evaluating control settings for Decryption Policies and Figure 12-3 on page 246 shows the order when evaluating control settings for IronPort Data Security Policies.

EVALUATING ACCESS POLICY GROUP MEMBERSHIP

After the Web Proxy assigns an Identity to a client request, the Web Proxy evaluates the request against the other policy types to determine which policy group it belongs for each type. When the HTTPS Proxy is enabled, the Web Proxy applies HTTP and *decrypted* HTTPS requests against the Access Policies. When the HTTPS Proxy is not enabled, by default, the Web Proxy evaluates HTTP and all HTTPS requests against the Access Policies.

The Web Proxy applies the configured policy control settings to a client request based on the client request's policy group membership.

To determine the policy group that a client request matches, the Web Proxy follows a very specific process for matching the group membership criteria. During this process, it considers the following factors for group membership:

- **Identity.** Each client request either matches an Identity, fails authentication and is granted guest access, or fails authentication and gets terminated. For more information about evaluating Identity group membership, see “Evaluating Identity Group Membership” on page 147.
- **Authorized users.** If the assigned Identity requires authentication, the user must be in the list of authorized users in the Access Policy group to match the policy group. The list of authorized users can be any of the specified groups or users or guest users if the Identity allows guest access.
- **Advanced options.** You can configure several advanced options for Access Policy group membership. Some of the options (such as proxy port, and URL category) can also be defined within the Identity. When an advanced option is configured in the Identity, it is not configurable in the Access Policy group level.

The information in this section gives an overview of how the Web Proxy matches client requests to Access Policy groups. For more details about exactly how the Web Proxy matches client requests, see “Matching Client Requests to Access Policy Groups” on page 172.

The Web Proxy sequentially reads through each policy group in the policies table. It compares the client request status to the membership criteria of the first policy group. If they match, the Web Proxy applies the policy settings of that policy group.

If they do not match, the Web Proxy compares the client request to the next policy group. It continues this process until it matches the client request to a user defined policy group, or if it does not match a user defined policy group, it matches the global policy group. When the Web Proxy matches the client request to a policy group or the global policy group, it applies the policy settings of that policy group.

Matching Client Requests to Access Policy Groups

Figure 9-1 on page 173 shows how the Web Proxy evaluates a client request against the Access Policy groups.

Figure 9-1 Policy Group Flow Diagram for Access Policies

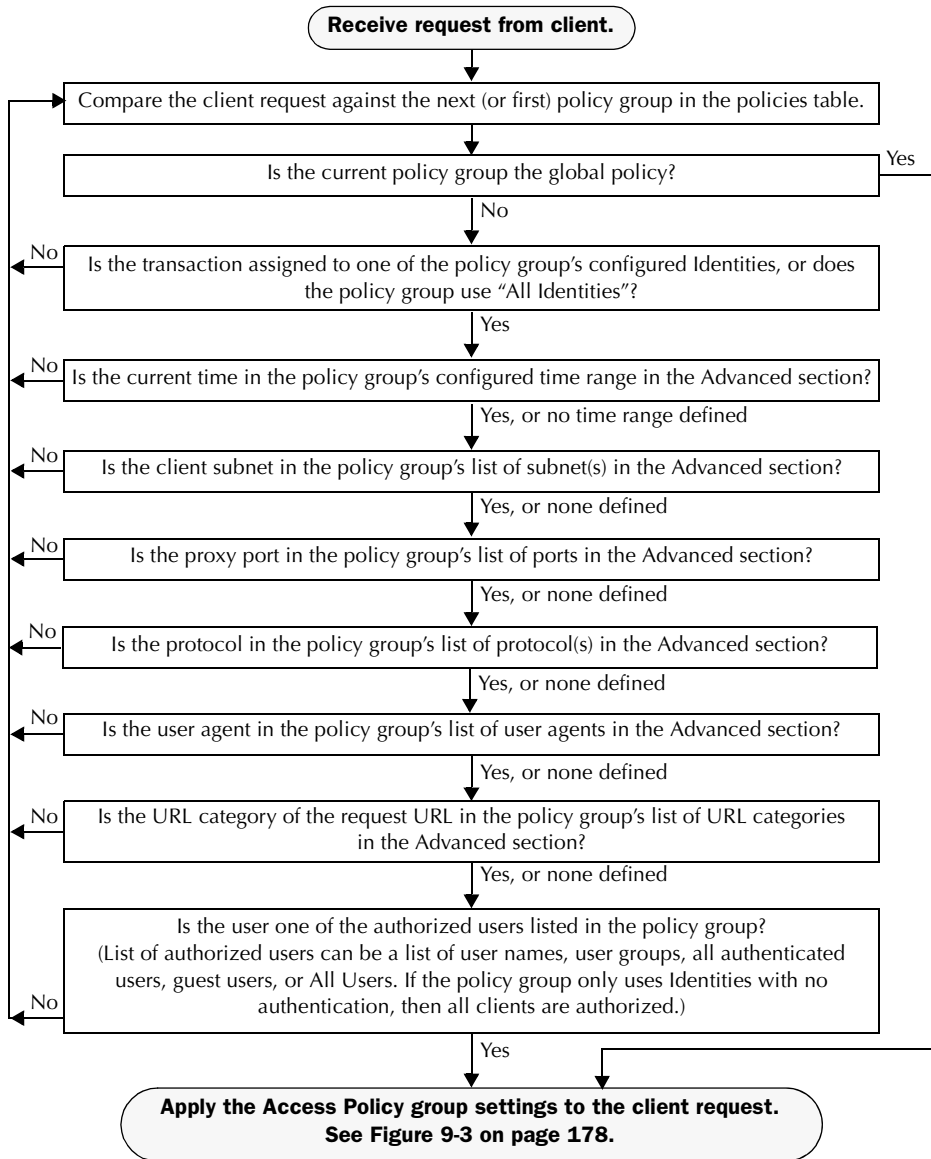

CREATING ACCESS POLICIES

You can create Access Policy groups based on combinations of several criteria, such as one or more Identities or the URL category of the destination site. You must define at least one criterion for policy group membership. When you define multiple criteria, the client request must meet all criteria to match the policy group. However, the client request needs to match only one of the configured Identities.

For more information about how the Web Proxy matches a client request with a policy group, see “Evaluating Access Policy Group Membership” on page 172 and “Matching Client Requests to Access Policy Groups” on page 172.

You define policy group membership on the Web Security Manager > Access Policies page.

To create an Access Policy group:

1. Navigate to the Web Security Manager > Access Policies page.
2. Click **Add Policy**.
3. In the Policy Name field, enter a name for the policy group, and in the Description field, optionally add a description.
4. In the Insert Above Policy field, choose where in the policies table to place the policy group.

When configuring multiple policy groups you must specify a logical order for each group. Carefully order your policy groups to ensure that correct matching occurs.

5. In the Identities and Users section, choose one or more Identity groups to apply to this policy group.

For more information on how to do this, see “Configuring Identities in Other Policy Groups” on page 162.

6. Optionally, expand the Advanced section to define additional membership requirements.

Policy Member Definition

Membership is defined by the combination of the following options. All criteria must be met for the policy to take effect.

Identities and Users:	<div style="border: 1px solid #ccc; padding: 2px; margin-bottom: 5px;"> ▼ Select One or More Identities </div> <table style="width: 100%; border-collapse: collapse;"> <tr> <td style="width: 50%; border-bottom: 1px solid #ccc; padding: 2px;">Identity</td> <td style="width: 30%; border-bottom: 1px solid #ccc; padding: 2px;">Authorized Users and Groups</td> <td style="width: 20%; border-bottom: 1px solid #ccc; padding: 2px; text-align: right;">Add Identity</td> </tr> <tr> <td style="border-bottom: 1px solid #ccc; padding: 2px;">Select Identity...</td> <td style="border-bottom: 1px solid #ccc; padding: 2px;">No identity selected</td> <td style="border-bottom: 1px solid #ccc; padding: 2px; text-align: right;">🗑️</td> </tr> </table>	Identity	Authorized Users and Groups	Add Identity	Select Identity...	No identity selected	🗑️
Identity	Authorized Users and Groups	Add Identity					
Select Identity...	No identity selected	🗑️					
<div style="font-size: small; margin-top: 5px;"> ▼ Advanced Use the Advanced options to define or edit membership by protocol, proxy port, subnet, Time Range, destination (URL Category), or User Agents. </div> <p style="font-size: x-small; margin-top: 5px;">The following advanced membership criteria have been defined:</p> <p>Protocols: None Selected</p> <p>Proxy Ports: None Selected</p> <p>Subnets: None Selected</p> <p>Time Range: None Selected</p> <p>URL Categories: None Selected</p> <p>User Agents: None Selected</p>							

7. To define policy group membership by any of the advanced options, click the link for the advanced option and configure the option on the page that appears.

Table 9-1 describes the advanced options you can configure for Access Policy groups.

Table 9-1 Access Policy Group Advanced Options

Advanced Option	Description
Protocols	<p>Choose whether or not to define policy group membership by the protocol used in the client request. Select the protocols to include. “All others” means any protocol not listed above this option.</p> <p>Note: When the HTTPS Proxy is enabled, only Decryption Policies apply to HTTPS transactions. You cannot define policy membership by the HTTPS protocol for Access, Routing, or IronPort Data Security Policies.</p>
Proxy Ports	<p>Choose whether or not to define policy group membership by the proxy port used to access the Web Proxy. Enter one or more port numbers in the Proxy Ports field. Separate multiple ports with commas.</p> <p>For explicit forward connections, this is the port configured in the browser. For transparent connections, this is the same as the destination port. You might want to define policy group membership on the proxy port if you have one set of clients configured to explicitly forward requests on one port, and another set of clients configured to explicitly forward requests on a different port.</p> <p>IronPort recommends only defining policy group membership by the proxy port when the appliance is deployed in explicit forward mode, or when clients explicitly forward requests to the appliance. When you define policy group membership by the proxy port when client requests get transparently redirected to the appliance, some requests might be denied.</p> <p>Note: If the Identity associated with this policy group defines Identity membership by this advanced setting, the setting is not configurable at the non-Identity policy group level.</p>
Subnets	<p>Choose whether or not to define policy group membership by subnet or other addresses.</p> <p>You can choose to use the addresses that may be defined with the associated Identity, or you can enter specific addresses here.</p> <p>Note: If the Identity associated with this policy group defines its membership by addresses, then in this policy group you must enter addresses that are a subset of the Identity’s addresses. Adding addresses in the policy group further narrows down the list of transactions that match this policy group.</p>

Table 9-1 Access Policy Group Advanced Options (Continued)

Advanced Option	Description
Time Range	<p>Choose whether or not to define policy group membership by a defined time range. Choose the time range from the Time Range field and then choose whether this policy group should apply to the times inside or outside the selected time range.</p> <p>For more information on creating time based policies, see “Working with Time Based Policies” on page 136.</p> <p>For more information on creating time ranges, see “Creating Time Ranges” on page 136.</p>
URL Categories	<p>Choose whether or not to define policy group membership by URL categories. Select the user defined or predefined URL categories.</p> <p>Note: If the Identity associated with this policy group defines Identity membership by this advanced setting, the setting is not configurable at the non-Identity policy group level.</p>
User Agents	<p>Choose whether or not to define policy group membership by the user agent used in the client request. You can select some commonly defined browsers, or define your own using regular expressions. Choose whether this policy group should apply to the selected user agents or to any user agent that is not in the list of selected user agents.</p> <p>For more information on creating user agent based policies, see “Working with User Agent Based Policies” on page 138.</p> <p>Note: If the Identity associated with this policy group defines Identity membership by this advanced setting, the setting is not configurable at the non-Identity policy group level.</p>

8. Submit your changes.
9. Configure Access Policy group control settings to define how the Web Proxy handles transactions.

The new Access Policy group automatically inherits global policy group settings until you configure options for each control setting. For more information, “Controlling HTTP and Native FTP Traffic” on page 177.

10. Submit and commit your changes.

CONTROLLING HTTP AND NATIVE FTP TRAFFIC

After the Web Proxy assigns an HTTP, native FTP, or decrypted HTTPS request to an Access Policy group, the request inherits the control settings of that policy group. The control settings of the Access Policy group determine whether the appliance allows, blocks, or redirects the connection.

Configure control settings for Access Policy groups on the Web Security Manager > Access Policies page.

Figure 9-2 shows where you can configure control settings for the Access Policy groups.

Figure 9-2 Creating Secure Access Policies

Access Policies

Policies						
<input type="button" value="Add Policy..."/>						
Order	Group	Applications	URL Categories	Objects	Web Reputation and Anti-Malware Filtering	Delete
1	exampleAccessPolicy Identity: TestLab	(global policy)	Redirect: 0 Monitor: 53 Block: 0 Allow: 0 Time-Based: 0	(global policy)	(global policy)	
	Global Policy Identity: All	Allow: FTP over HTTP, HTTP Allow: Ports 8080, 21,...	Redirect: 0 Monitor: 53 Block: 0 Allow: 0	Object Max Size: None	(enabled)	

Authentication: Enabled Disabled

You can configure the following settings to determine what action to take on the request:

- **Applications.** For more information, see “Applications” on page 179.
- **URL Categories.** For more information, see “URL Categories” on page 179.
- **Objects.** For more information, see “Object Blocking” on page 180.
- **Web Reputation and Anti-Malware Filtering.** For more information, see “Web Reputation and Anti-Malware” on page 181.

After an Access Policy group is assigned to a request, the control settings for the policy group are evaluated to determine whether to allow, block, or redirect the request. For more information about assigning an Access Policy group to a request, see “Policy Group Membership” on page 133.

Figure 9-3 on page 178 shows how the Web Proxy determines which action to take on a request after it has assigned a particular Access Policy to the request.

Figure 9-3 Applying Access Policy Actions

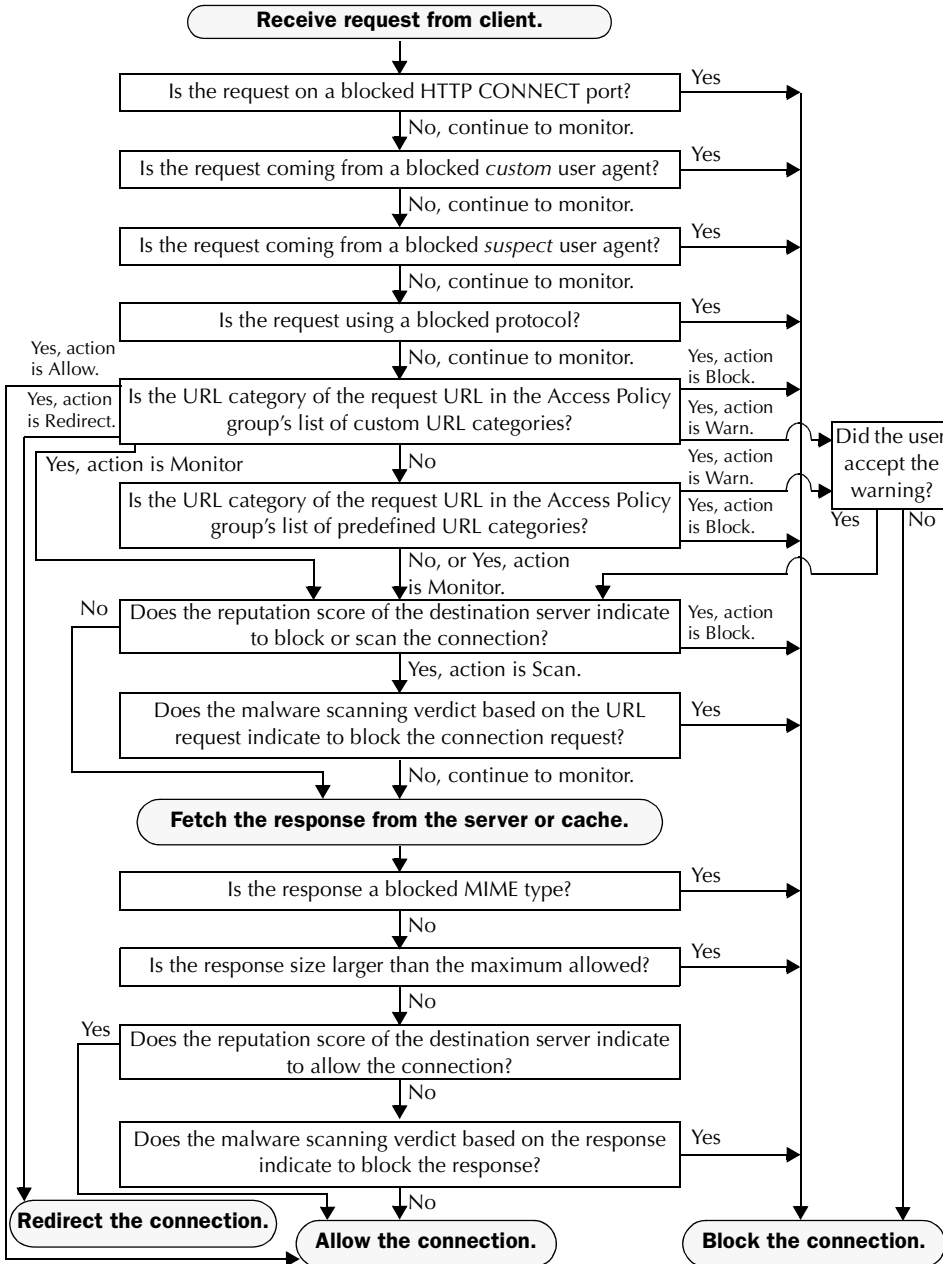

Figure 9-3 on page 178 shows two different decision points that involve the web reputation score of the destination server. The web reputation score of the server is evaluated only once, but the result is applied at two different points in the decision flow.

Applications

You can use the Applications settings on the Access Policies > Applications page to control policy group access to protocols and configure blocking for Internet applications (also known as user agents), such as instant messaging clients, web browsers, and Internet phone services. You can also configure the appliance to tunnel HTTP CONNECT requests on specific ports. With tunneling enabled, the appliance passes HTTP traffic through specified ports without evaluating it.

For more information about blocking user agents, see “Blocking Specific Applications and Protocols” on page 182.

Figure 9-4 Custom Settings for Controlling Applications

Access Policies: Applications: Global Policy

Edit Applications Settings	
Define Applications Custom Settings <input type="button" value="v"/>	
Protocol Controls	
Block Protocols:	<input type="checkbox"/> FTP over HTTP <input type="checkbox"/> HTTP <small>Note: Blocking of HTTPS is not available in Access policies when the HTTPS proxy is enabled. If the HTTPS proxy is enabled, use Decryption policies to control HTTPS access.</small>
HTTP CONNECT Ports:	<input type="text" value="8080, 21, 443, 563, 8443, 20"/> <small>HTTP CONNECT enables applications to tunnel outbound traffic over HTTP, unless the protocol is blocked above. Enter 1-65535 to allow all ports via HTTP CONNECT. Leave field blank to block all ports.</small>
Custom User Agents	
Block Custom User Agents:	<div style="border: 1px solid #ccc; height: 40px; width: 100%;"></div> <small>(Enter any regular expression, one regular expression per line, to block user agents.)</small>
Example User Agent Patterns <input type="button" value="v"/>	

Note — When the HTTPS Proxy is enabled, you can only use Decryption Policies to control access to HTTPS transactions. You cannot configure Access Policies on this page to block HTTPS connections.

URL Categories

AsyncOS for Web allows you to configure how the appliance handles a transaction based on the URL category of a particular HTTP or HTTPS request. Using a predefined category list, you can choose to monitor or block content by category. You can also create custom URL categories and choose to allow, monitor, block, or redirect traffic for a website in the custom

category. You can use custom URL categories to create block and allow lists based on destination.

For more information about enabling a URL filtering engine and working with URL categories, see “URL Filters” on page 287.

Object Blocking

You can use the settings on the Access Policies > Objects page to configure the proxy to block file downloads based on file characteristics, such as file size and file type. For more information about blocking a specific object or MIME-type, see “Blocking Specific Applications and Protocols” on page 182.

Note — When you block Microsoft Office files in the Block Object Type section, it is possible that some Microsoft Office files will not be blocked. If you need to be sure to block all Microsoft Office files, add `application/x-ole` in the Block Custom MIME Types field. However, blocking this custom MIME type also blocks all Microsoft Compound Object format types, such as Visio files and some third party applications.

Figure 9-5 Blocking Object Types

Access Policies: Objects: exampleAccessPolicy

Edit Objects Blocking Settings	
Define Custom Objects Blocking Settings ▾	
Objects Blocking Settings	
Object Size	
HTTP/HTTPS Max Download Size:	<input type="radio"/> 0 MB <input checked="" type="radio"/> No Maximum
FTP Max Download Size:	<input type="radio"/> 0 MB <input checked="" type="radio"/> No Maximum
Block Object Type	
Object and MIME Type Reference	
<ul style="list-style-type: none"> ▸ Archives ▸ Document Types ▸ Executable Code ▸ Installers ▸ Media ▸ P2P Metafiles ▸ Web Page Content 	
Custom MIME Types	
Object and MIME Type Reference	
Block Custom MIME Types:	<div style="border: 1px solid black; height: 100px; width: 100%;"></div>
<small>(Enter multiple entries on separate lines. Example: audio/x-mpeg3 or audio/* are valid entries.)</small>	

Web Reputation and Anti-Malware

The Web Reputation and Anti-Malware Filtering policy inherits global settings respective to each component. To customize filtering and scanning for a particular policy group, you can use the Web Reputation and Anti-Malware Settings pull-down menu to customize monitoring or blocking for malware categories based on malware scanning verdicts and to customize web reputation score thresholds.

For more information about configuring web reputation scores, see “Configuring Web Reputation Scores” on page 335.

For more information about configuring anti-malware settings, see “Configuring Anti-Malware Scanning” on page 348.

BLOCKING SPECIFIC APPLICATIONS AND PROTOCOLS

AOL Messenger, BitTorrent, Skype—the Web Security appliance can control and block access to these types of applications. You can configure how the appliance manages these kinds of applications based on the port being used:

- **Port 80.** You can control how the Web Security appliance manages these applications using Access Policies, but only as they are accessed via HTTP tunneling on port 80.
- **Ports other than 80.** You can block these applications on other ports by using the L4 Traffic Monitor.

Use the Web Security Manager > Access Policies page to manage access and monitoring for these types of applications on a more granular (per policy) level. Use the L4 Traffic Monitor to manage access and monitoring on a more global basis.

Blocking on Port 80

To block access to these types of applications where port 80 is used, you can use the Web Security Manager > Access Policies page. The Access Policies page provides several methods for blocking access. You can block access by clicking on any of the following columns for a particular policy group:

- Applications
- URL Categories
- Objects

You can block access to predefined URL categories such as Chat and Peer-to-Peer, or create your own custom URL categories. You can block specific applications based on their “agent patterns” or signatures.

You can apply some or all of these methods on various Access Policies by creating additional Access Policy groups. For details on how to create additional Access Policy groups, see “Creating Access Policies” on page 174.

Policy: Applications

You can create a rule that blocks a particular user agent based on its pattern using Regular Expressions.

You block access to applications based on their agent pattern similarly for the different Access Policies:

- **User defined policies** — On the Web Security Manager > Access Policies page, click the value in the Applications column for the desired policy. Choose Define Applications Custom Settings.
- **Global Policy** — On the Web Security Manager > Access Policies page, click the value in the Applications column for the Global Policy.

Once you view the Access Policies: Applications: *Policy_Name* page, add user agent patterns (also called signatures) to the Block Custom User Agents section of the page.

Figure 9-6 Entering Agent Patterns to Block

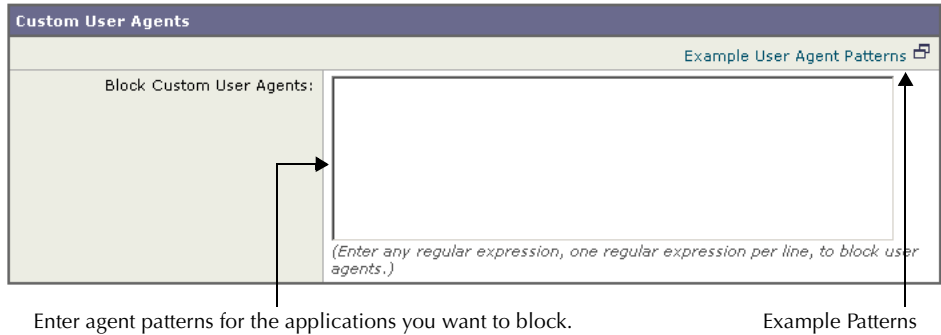

Note — You can click the Example User Agent Patterns link for a list of some example user agent patterns.

Table 9-2 provides a list of common patterns.

Table 9-2 Common Application Agent Patterns

Application	Search in Setting	HTTP header	Signature
AOL Messenger	Request headers	User-Agent	Gecko/
BearShare	Response header	Server	Bearshare
BitTorrent	Request headers	User-Agent	BitTorrent
eDonkey	Request headers	User-Agent	e2dk
Gnutella	Request headers	User-Agent	Gnutella Gnucleus
Kazaa	Request headers	P2P-Agent	Kazaa Kazaaclient:
Kazaa	Request headers	User-Agent	KazaClient Kazaaclient:
Kazaa	Request headers	X-Kazaa-Network	KaZaA
Morpheus	Response header	Server	Morpheus
MSN Messenger	Request headers	User-Agent	MSN Messenger

Table 9-2 Common Application Agent Patterns (Continued)

Application	Search in Setting	HTTP header	Signature
Trillian	Request headers	User-Agent	Trillian/
Windows Messenger	Request headers	User-Agent	MSMSGSGS
Yahoo Messenger	Request headers	Host	msg.yahoo.com
Yahoo Messenger	Request headers	User-Agent	ymsggr

This is not a comprehensive list, as signatures change occasionally, and new applications are developed. You can find additional signatures at various websites, including the following websites:

- <http://www.user-agents.org/>
- <http://www.useragentstring.com/pages/useragentstring.php>
- <http://www.infosyssec.com/infosyssec/security/useragentstrings.shtml>

Note — IronPort Systems does not maintain, verify, or support the user agent listings at any of these websites.

Policy: URL Categories

You can specify categories of URLs to block, including the predefined “Chat” and “Peer-to-Peer” categories. You can also add specific custom URL categories should you want to add a URL that is not already included in the predefined categories. You may then add the custom category to the list of blocked URLs.

For more information about using URL Categories, see “URL Categories” on page 179.

Policy: Objects

You can block some Peer-to-Peer files directly, via the Access Policies: Objects: Global Policy page.

On the Web Security Manager > Access Policies page, click on the value in the Objects column for the desired policy.

In the Block Object Type section, check any boxes in the P2P Metafiles group. You can add custom MIME (Multipurpose Internet Mail Extensions) types by entering them in the Custom MIME Types field. For example, entering the `application/x-zip` signature blocks ZIP archive files.

Blocking on Ports Other Than 80

If these applications are using ports other than 80, you may want to block access to a specific server or block of IP addresses to which the client must connect. To manage these applications on other ports, use the L4 Traffic Monitor. The L4 Traffic monitor allows you to

restrict access on specific ports. However, the restriction is global, so it will apply to all traffic on that port.

Working with External Proxies

This chapter contains the following topics:

- “Working with External Proxies Overview” on page 188
- “Routing Traffic to Upstream Proxies” on page 189
- “Adding External Proxy Information” on page 191
- “Evaluating Routing Policy Group Membership” on page 193
- “Creating Routing Policies” on page 195

WORKING WITH EXTERNAL PROXIES OVERVIEW

The Web Security appliance is a proxy-compatible device, and is easily deployed within an existing proxy environment. However, it is recommended that you place the appliance downstream from existing proxy servers, meaning closer to the clients.

You can configure the appliance to work with multiple existing, upstream proxies. Use the Network > Upstream Proxies page to define upstream proxies or to modify existing settings. You define groups of proxies, and you can configure the appliance to use load balancing and failover features when connecting to multiple proxies.

After defining proxy groups, you can create Routing Policies to determine whether the Web Proxy connects to the server identified by the client or to a member of one the proxy groups.

For more information about using Routing Policies to route transactions, see “Routing Traffic to Upstream Proxies” on page 189. For more information about defining external proxies, see “Adding External Proxy Information” on page 191.

ROUTING TRAFFIC TO UPSTREAM PROXIES

When the Web Proxy does not deliver a response from the cache, it can direct client requests directly to the destination server or to an external proxy on the network. You use Routing Policies to create rules that indicate when and to where to direct transactions. A Routing Policy determines to where to pass the client request, either to another proxy (as defined by the proxy group) or to the destination server. It addresses the question, “from where to fetch content?” You might want to create Routing Policies if you have a highly distributed network.

Figure 10-1 shows Routing Policies on the Web Security Manager > Routing Policies page.

Figure 10-1 Routing Policies

Routing Policies

Routing Definitions			
Add Policy...			
Order	Members	Routing Destination	Delete
1	LondonOffice Identity: LondonOffice	ProxyGroup2 10.8.8.8:3128, 10.8.8.9:3128, 10.8.8.10:3128	
2	TestLab Identity: TestLab	Direct Connection	
Global Routing Policy			
		ProxyGroup1 10.1.1.1:3128, 10.1.1.2:3128	

When you define multiple external proxies in a proxy group, the Web Proxy can use load balancing techniques to distribute requests to different proxies defined in the group. You can choose the following load balancing techniques:

- **None (failover).** The Web Proxy directs transactions to one external proxy in the group. It tries to connect to the proxies in the order they are listed. If one proxy cannot be reached, the Web Proxy attempts to connect to the next one in the list.
- **Fewest connections.** The Web Proxy keeps track of how many active requests are with the different proxies in the group and it directs a transaction to the proxy currently servicing the fewest number of connections.
- **Hash based.** The Web Proxy uses a hash function to distribute requests to the proxies in the group. The hash function uses the proxy ID and URL as inputs so that requests for the same URL are always directed to the same external proxy.
- **Least recently used.** The Web Proxy directs a transaction to the proxy that least recently received a transaction if all proxies are currently active. This setting is similar to round robin except the Web Proxy also takes into account transactions a proxy has received by being a member in a different proxy group. That is, if a proxy is listed in multiple proxy groups, the “least recently used” option is less likely to overburden that proxy.
- **Round robin.** The Web Proxy cycles transactions equally among all proxies in the group in the listed order.

For information about creating Routing Policies, see “Creating Routing Policies” on page 195.

Note — If your network contains an upstream proxy that does not support FTP connections, then you must create a Routing Policy that applies to all Identities and to just FTP requests. Configure that Routing Policy to directly connect to FTP servers or to connect to a proxy group whose proxies all support FTP connections.

ADDING EXTERNAL PROXY INFORMATION

To define external proxy information, you create a proxy group. A proxy group is an object that defines a list of proxies and their connection information and the load balancing technique to use when distributing requests to proxies in the group. You can create multiple proxy groups and can define multiple proxies within a group.

AsyncOS for Web allows you to enter the same proxy server information multiple times into the same proxy group. You might want to include the same proxy server multiple times to allow unequal load distribution among the proxies in the proxy group.

Note — You can only specify one existing proxy during the System Setup Wizard. AsyncOS creates a proxy group with one proxy using the information you enter in the System Setup Wizard. You can specify additional proxies in the web interface after initial setup.

To create a proxy group:

1. Navigate to Network > Upstream Proxies, and click **Add Group**.

The Add Upstream Proxy Group page appears.

Add Upstream Proxy Group

Proxy Group			
Name:	<input type="text"/>		
Proxy Servers:	Proxy Address	Port	Reconnection Attempts (?) Add Row
	<input type="text"/> <small>hostname or IP address</small>	<input type="text" value="8128"/>	<input type="text" value="2"/> <small>Any number great than 0.</small>
Load Balancing (?)	<input type="text" value="None (Failover)"/>		
Failure Handling:	<small>Specify how to handle requests if all proxies in this group fail.</small>		
	<input checked="" type="radio"/> Connect directly to destination host <input type="radio"/> Drop requests		

2. Enter a name for the proxy group in the Name field.
3. In the Proxy Servers section, define at least one external proxy.
 - a. In the Proxy Address field, enter the host name or IP address of the proxy server.
 - b. In the Port field, enter the port number used to access the proxy.
 - c. In the Reconnection Attempts field, enter the number of times the Web Proxy should try to connect to the proxy server before ignoring it.
 - d. Optionally, you can define another proxy server by clicking Add Row.
4. In the Load Balancing field, choose the method the Web Proxy should use to distribute transactions to the proxies when the group contains multiple proxies.

For more information about the load balancing options, see “Routing Traffic to Upstream Proxies” on page 189.

5. In the Failure Handling field, choose how the Web Proxy should handle transactions when all proxies in the group fail.
6. Submit and commit your changes.

EVALUATING ROUTING POLICY GROUP MEMBERSHIP

After the Web Proxy assigns an Identity to a client request, it evaluates the request against the other policy types to determine which policy group it belongs for each type. Any request that does not get terminated due to failed authentication gets evaluated against the Routing Policies to determine from where to fetch the data.

Once the Web Proxy assigns a Routing Policy group to a request, it fetches the content from the location configured for the policy group, either from a configured proxy group or directly from the server.

To determine the policy group that a client request matches, the Web Proxy follows a very specific process for matching the group membership criteria. During this process, it considers the following factors for group membership:

- **Identity.** Each client request either matches an Identity, fails authentication and is granted guest access, or fails authentication and gets terminated. For more information about evaluating Identity group membership, see “Evaluating Identity Group Membership” on page 147.
- **Authorized users.** If the assigned Identity requires authentication, the user must be in the list of authorized users in the Routing Policy group to match the policy group.
- **Advanced options.** You can configure several advanced options for Routing Policy group membership. Some of the options (such as proxy port, and URL category) can also be defined within the Identity. When an advanced option is configured in the Identity, it is not configurable in the Routing Policy group level.

The information in this section gives an overview of how the appliance matches client requests to Routing Policy groups. For more details about exactly how the appliance matches client requests, see “Matching Client Requests to Routing Policy Groups” on page 193.

The Web Proxy sequentially reads through each policy group in the policies table. It compares the client request status to the membership criteria of the first policy group. If they match, the Web Proxy applies the policy settings of that policy group.

If they do not match, the Web Proxy compares the client request to the next policy group. It continues this process until it matches the client request to a user defined policy group, or if it does not match a user defined policy group, it matches the global policy group. When the Web Proxy matches the client request to a policy group or the global policy group, it applies the policy settings of that policy group.

Matching Client Requests to Routing Policy Groups

Figure 10-2 on page 194 shows how the Web Proxy evaluates a client request against the Routing Policy groups.

Figure 10-2 Policy Group Flow Diagram for Routing Policies

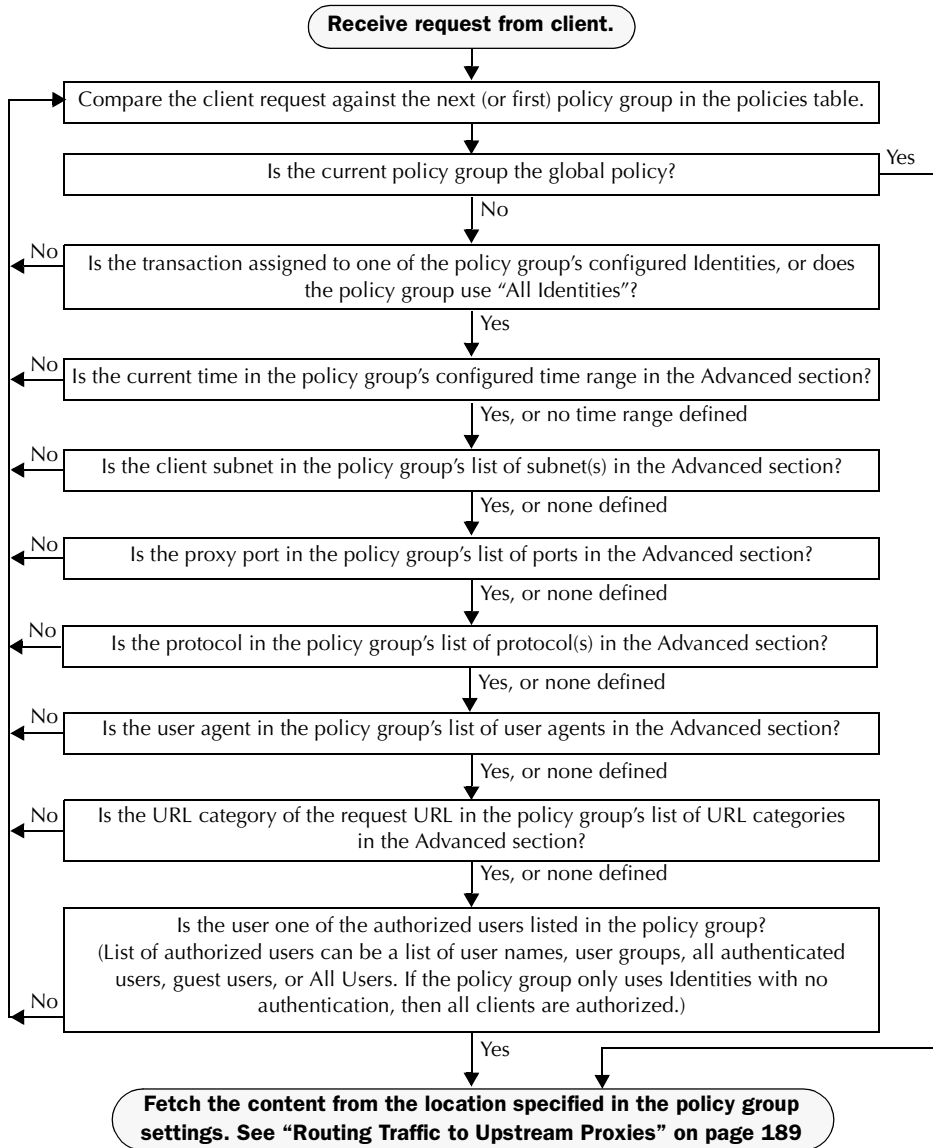

CREATING ROUTING POLICIES

You can create Routing Policy groups based on combinations of several criteria, such as Identity or the port used to access the Web Proxy. You must define at least one criterion for policy group membership. When you define multiple criteria, the client request must meet all criteria to match the policy group.

For more information about how the appliance matches a client request with a policy group, see “Evaluating Routing Policy Group Membership” on page 193 and “Matching Client Requests to Routing Policy Groups” on page 193.

You define policy group membership on the Web Security Manager > Routing Policies page.

To create a Routing Policy group:

1. Navigate to the Web Security Manager > Routing Policies page.
2. Click **Add Group**.
3. In the Policy Name field, enter a name for the policy group, and in the Description field, optionally add a description.
4. In the Insert Above Policy field, choose where in the policies table to place the policy group.

When configuring multiple policy groups you must specify a logical order for each group. Carefully order your policy groups to ensure that correct matching occurs.

5. In the Identities and Users section, choose one or more Identity groups to apply to this policy group.

For more information on how to do this, see “Configuring Identities in Other Policy Groups” on page 162.

6. Optionally, expand the Advanced section to define additional membership requirements.

Policy Member Definition							
<i>Membership is defined by the combination of the following options. All criteria must be met for the policy to take effect.</i>							
Identities and Users:	<div style="border: 1px solid #ccc; padding: 5px;"> <div style="display: flex; justify-content: space-between; align-items: center;"> Select One or More Identities ▾ </div> <table border="1" style="width: 100%; border-collapse: collapse;"> <tr> <td style="width: 50%; padding: 2px;">Identity</td> <td style="width: 30%; padding: 2px;">Authorized Users and Groups</td> <td style="width: 20%; padding: 2px; text-align: center;">Add Identity</td> </tr> <tr> <td style="padding: 2px;">Select Identity... ▾</td> <td style="padding: 2px;">No identity selected</td> <td style="padding: 2px; text-align: center;">✖</td> </tr> </table> </div>	Identity	Authorized Users and Groups	Add Identity	Select Identity... ▾	No identity selected	✖
Identity	Authorized Users and Groups	Add Identity					
Select Identity... ▾	No identity selected	✖					
<div style="display: flex; align-items: flex-start;"> <div style="width: 20px; text-align: center; font-size: 10px;">▾</div> <div style="width: 10px; font-size: 10px;">Advanced</div> </div>	<p>Use the Advanced options to define or edit membership by protocol, proxy port, subnet, Time Range, destination (URL Category), or User Agents.</p> <p>The following advanced membership criteria have been defined:</p> <p>Protocols: None Selected</p> <p>Proxy Ports: None Selected</p> <p>Subnets: None Selected</p> <p>Time Range: None Selected</p> <p>URL Categories: None Selected</p> <p>User Agents: None Selected</p>						

7. To define policy group membership by any of the advanced options, click the link for the advanced option and configure the option on the page that appears.

Table 10-1 describes the advanced options you can configure for policy groups.

Table 10-1 Policy Group Advanced Options

Advanced Option	Description
Protocols	<p>Choose whether or not to define policy group membership by the protocol used in the client request. Select the protocols to include. "All others" means any protocol not listed above this option.</p> <p>Note: When the HTTPS Proxy is enabled, only Decryption Policies apply to HTTPS transactions. You cannot define policy membership by the HTTPS protocol for Access, Routing, or IronPort Data Security Policies.</p>
Proxy Ports	<p>Choose whether or not to define policy group membership by the proxy port used to access the Web Proxy. Enter one or more port numbers in the Proxy Ports field. Separate multiple ports with commas.</p> <p>For explicit forward connections, this is the port configured in the browser. For transparent connections, this is the same as the destination port. You might want to define policy group membership on the proxy port if you have one set of clients configured to explicitly forward requests on one port, and another set of clients configured to explicitly forward requests on a different port.</p> <p>IronPort recommends only defining policy group membership by the proxy port when the appliance is deployed in explicit forward mode, or when clients explicitly forward requests to the appliance. When you define policy group membership by the proxy port when client requests get transparently redirected to the appliance, some requests might be denied.</p> <p>Note: If the Identity associated with this policy group defines Identity membership by this advanced setting, the setting is not configurable at the non-Identity policy group level.</p>
Subnets	<p>Choose whether or not to define policy group membership by subnet or other addresses.</p> <p>You can choose to use the addresses that may be defined with the associated Identity, or you can enter specific addresses here.</p> <p>Note: If the Identity associated with this policy group defines its membership by addresses, then in this policy group you must enter addresses that are a subset of the Identity's addresses. Adding addresses in the policy group further narrows down the list of transactions that match this policy group.</p>

Table 10-1 Policy Group Advanced Options (Continued)

Advanced Option	Description
Time Range	<p>Choose whether or not to define policy group membership by a defined time range. Choose the time range from the Time Range field and then choose whether this policy group should apply to the times inside or outside the selected time range.</p> <p>For more information on creating time based policies, see “Working with Time Based Policies” on page 136.</p> <p>For more information on creating time ranges, see “Creating Time Ranges” on page 136.</p>
URL Categories	<p>Choose whether or not to define policy group membership by URL categories. Select the user defined or predefined URL categories.</p> <p>Note: If the Identity associated with this policy group defines Identity membership by this advanced setting, the setting is not configurable at the non-Identity policy group level.</p>
User Agents	<p>Choose whether or not to define policy group membership by the user agent used in the client request. You can select some commonly defined browsers, or define your own using regular expressions. Choose whether this policy group should apply to the selected user agents or to any user agent that is not in the list of selected user agents.</p> <p>For more information on creating user agent based policies, see “Working with User Agent Based Policies” on page 138.</p> <p>Note: If the Identity associated with this policy group defines Identity membership by this advanced setting, the setting is not configurable at the non-Identity policy group level.</p>

8. Submit your changes.
9. Configure Routing Policy group control settings to define how the Web Proxy handles transactions.

The new policy group automatically inherits global policy group settings until you configure options for each control setting. For more information, see “Routing Traffic to Upstream Proxies” on page 189.

10. Submit and commit your changes.

Decryption Policies

This chapter contains the following information:

- “Decryption Policies Overview” on page 200
- “Digital Cryptography Terms” on page 204
- “HTTPS Basics” on page 206
- “Digital Certificates” on page 208
- “Decrypting HTTPS Traffic” on page 211
- “Enabling the HTTPS Proxy” on page 217
- “Evaluating Decryption Policy Group Membership” on page 221
- “Creating Decryption Policies” on page 223
- “Controlling HTTPS Traffic” on page 227
- “Importing a Trusted Root Certificate” on page 231

DECRYPTION POLICIES OVERVIEW

HTTPS is a web protocol that acts as a secure form of HTTP. HTTPS encrypts HTTP requests and responses before they are sent across the network. Common thinking is that any connection to a site using HTTPS is “safe.” HTTPS connections are secure, not safe, and they do not discriminate against malicious or compromised servers. HTTPS is a secure way to complete legitimate transactions, but more dangerously, it is a secure way to download malware which can infect your network.

Not being able to inspect HTTPS traffic makes the network vulnerable to the following risks:

- **Secure site hosting malware.** Spammers and phishers can create legitimate looking websites that are only reachable through an HTTPS connection. Some users may mistakenly trust the web server because it requires an HTTPS connection, resulting in intentional and unintentional downloaded malware.
- **Malware from HTTPS web applications.** Some malware can infect the network from legitimate web applications, such as secure email clients, by downloading attachments.
- **Secure anonymizing proxy.** Some web servers offer a proxy service over an HTTPS connection that allows users to circumvent acceptable use policies. When users on the network use a secure proxy server outside the network, they can access any website, regardless of its web reputation or malware content.

The appliance uses both a URL filtering engine and IronPort Web Reputation Filters to make intelligent decisions about when to decrypt HTTPS connections. With this combination, administrators and end users are not forced to make a trade-off between privacy and security.

You can define HTTPS policies that determine if an HTTPS connection can proceed without examination or whether the appliance should act as an intermediary, decrypting the data passing each way and applying Access Policies to the data as if it were a plaintext HTTP transaction.

To configure the appliance to handle HTTPS requests, you must perform the following tasks:

1. **Enable the HTTPS Proxy.** To monitor and decrypt HTTPS traffic, you must first enable the HTTPS Proxy. For more information, see “Enabling the HTTPS Proxy” on page 217.
2. **Create and configure Decryption Policy groups.** Once the HTTPS Proxy is enabled, you can create and configure Decryption Policy groups to determine how to handle each request from each user. For more information, see “Decryption Policy Groups” on page 201.
3. **Import custom root certificates (optional).** Optionally, you can import one or more custom root certificates so the Web Proxy can recognize additional trusted root certificate authorities used by HTTPS servers. For more information, see “Importing a Trusted Root Certificate” on page 231.

This book uses many terms from digital cryptography. This book also includes sections with background information about HTTPS and digital cryptography for reference only. For a list of

the terms and definitions used in this book, see “Digital Cryptography Terms” on page 204. For an overview of HTTPS the protocol, see “HTTPS Basics” on page 206.

Decryption Policy Groups

Decryption Policies define how the appliance should handle HTTPS connection requests for users on the network. You can apply different actions to specified groups of users. You can also specify which ports the appliance should monitor for HTTPS transactions.

When a client makes an HTTPS request on a monitored secure port, the appliance compares the request to the Decryption Policy groups to determine in which Decryption Policy group the request belongs. Once it assigns the request to a Decryption Policy group, it can determine what to do with the connection request. For more information about evaluating policy group membership, see “Policy Group Membership” on page 133.

The appliance can perform any of the following actions on an HTTPS connection request:

- **Drop.** The appliance drops the connection and does not pass the connection request to the server. The appliance does not notify the user that it dropped the connection. You might want to drop connections to third party proxies that allow users on the network bypass the organization’s acceptable use policies.
- **Pass through.** The appliance passes through the connection between the client and the server without inspecting the traffic content. You might want to pass through connections to trusted secure sites, such as well known banking and financial institutions.
- **Decrypt.** The appliance allows the connection, but inspects the traffic content. It decrypts the traffic and applies Access Policies to the decrypted traffic as if it were a plaintext HTTP connection. By decrypting the connection and applying Access Policies, you can scan the traffic for malware. You might want to decrypt connections to third party email providers, such as gmail or hotmail. For more information about how the appliance decrypts HTTPS traffic, see “Decrypting HTTPS Traffic” on page 211.

Note — The actions above are final actions the Web Proxy takes on an HTTPS request. The “Monitor” action you can configure for Decryption Policies is not a final action. For more information, see “Understanding the Monitor Action” on page 202.

Once the appliance assigns a Decryption Policy to an HTTPS connection request, it evaluates the request against the policy group’s configured control settings to determine which action to take. You can configure URL filter and web reputation settings to determine how to handle HTTPS requests for a particular policy group. For more information about how the appliance uses Decryption Policy groups to control HTTPS traffic, see “Controlling HTTPS Traffic” on page 227.

Note — IronPort recommends creating fewer, more general Decryption Policy groups that apply to all users or fewer, larger groups of users on the network. Then, if you need to apply more granular control to decrypted HTTPS traffic, use more specific Access Policy groups. For more information about Access Policy groups, see “Access Policies” on page 169.

For information about creating and using policy groups, see “Working with Policies” on page 125.

Note — The next two sections contain information about digital cryptography and HTTPS for reference only.

Personally Identifiable Information Disclosure

If you choose to decrypt an end-user’s HTTPS session, then the Web Security appliance access logs and reports may contain personally identifiable information. IronPort recommends that Web Security appliance administrators take care when handling this sensitive information.

You also have the option to configure how much URI text is stored in the logs using the `advancedproxyconfig` CLI command and the `HTTPS` subcommand. You can log the entire URI, or a partial form of the URI with the query portion removed. However, even when you choose to strip the query from the URI, personally identifiable information may still remain.

Understanding the Monitor Action

When the Web Proxy evaluates the control settings against a transaction, it evaluates the settings in a particular order. Each control setting can be configured to one of the following actions for Decryption Policies:

- Monitor
- Drop
- Pass through
- Decrypt

All actions except Monitor are final actions the Web Proxy applies to a transaction. A final action is an action that causes the Web Proxy to stop evaluating the transaction against other control settings.

Monitor is an intermediary action that indicates the Web Proxy should continue evaluating the transaction against the other control settings to determine which final action to ultimately apply.

For example, if a Decryption Policy is configured to monitor invalid server certificates, the Web Proxy makes no final decision on how to handle the HTTPS transaction if the server has an invalid certificate. If a Decryption Policy is configured to block servers with a low web reputation score, then any request to a server with a low reputation score is dropped without considering the URL category actions.

Figure 11-9 on page 229 shows the order the Web Proxy uses when evaluating control settings for Decryption Policies. Looking at the flow diagram, you can see that the only actions applied to a transaction are the final actions listed above: Drop, Pass Through, and Decrypt.

Note — Figure 9-3 on page 178 shows the order the Web Proxy uses when evaluating control settings for Access Policies.

DIGITAL CRYPTOGRAPHY TERMS

To understand how encryption and decryption works, you need to understand a little bit about cryptographic encoding techniques. Figure 11-1 describes some terms used in cryptography that are discussed in this chapter.

Table 11-1 Cryptography Terms and Definitions

Term	Definition
Certificate authority	An entity which issues digital certificates for use by other parties. Certificate authorities are sometimes referred to as trusted third parties. Certificate authorities are typically commercial companies that charge for their services. However, some institutions and governments have their own certificate authorities, and some offer their services for free.
Cipher	An algorithm used for encoding and decoding text to make it unreadable to any system without the appropriate key. Ciphers work with keys to encode or decode text.
Ciphertext	Encoded text after a cipher has been applied to it.
Digital certificate	An electronic document that identifies and describes an organization that has been verified and signed by a trusted organization called a certificate authority. A digital certificate is similar in concept to an “identification card.” SSL uses certificates to authenticate servers. For more information about digital certificates, see “Digital Certificates” on page 208.
Digital signature	A checksum that verifies that a message was created by the stated author and was not altered since its creation.
Key	A numeric parameter used by a cipher to encode or decode text.
Plaintext or cleartext	Message text in its original form, before it gets encoded by a cipher.
Public key cryptography	A system that uses two different keys for encoding and decoding text where one key is publicly known and available and the other key is private. With public key cryptography, anyone can send an encoded message to a server that has publicized its public key, but only the recipient server can decode the message with its private key. This is also known as asymmetric key cryptography.

Table 11-1 Cryptography Terms and Definitions (Continued)

Term	Definition
Public key infrastructure (PKI)	<p>An arrangement that binds public keys with respective user identities by means of a certificate authority.</p> <p>X.509 is a standard that is an example PKI. X.509 specifies standards for public key certificates and an algorithm for validating certification paths.</p>
Private key cryptography	<p>A system that uses the same key for encoding and decoding text. Because both sides of the transaction need the same key, they need a secure way to communicate which key to use in a particular communication session. Usually, they set up secure communication using public key cryptography and then generate a temporary symmetric key to use for the rest of the session. This is also known as symmetric key cryptography.</p>
Root certificate	<p>A certificate that is the topmost certificate in a certificate tree structure.</p> <p>All certificates below the root certificate inherit the trustworthiness of the root certificate.</p> <p>Root certificates can be unsigned public key certificates or self-signed certificates.</p>
Self-signed certificate	<p>A digital certificate where the certificate authority is the same as the certificate creator.</p>

HTTPS BASICS

HTTPS is a web protocol that acts as a secure form of HTTP. HTTPS is secure because the HTTP request and response data is encrypted before it is sent across the network. HTTPS works similarly to HTTP, except that the HTTP layer is sent on top of a security layer using either Secure Sockets Layer (SSL) or Transport Layer Security (TLS). SSL and TLS are very similar, so this User Guide uses “SSL” to refer to both SSL and TLS, unless otherwise specified.

Figure 11-1 shows the different OSI network layers for HTTPS and HTTP. It shows that HTTPS is the HTTP protocol at the application layer over SSL or TLS at the security layer.

Figure 11-1 HTTPS and HTTP OSI Layers

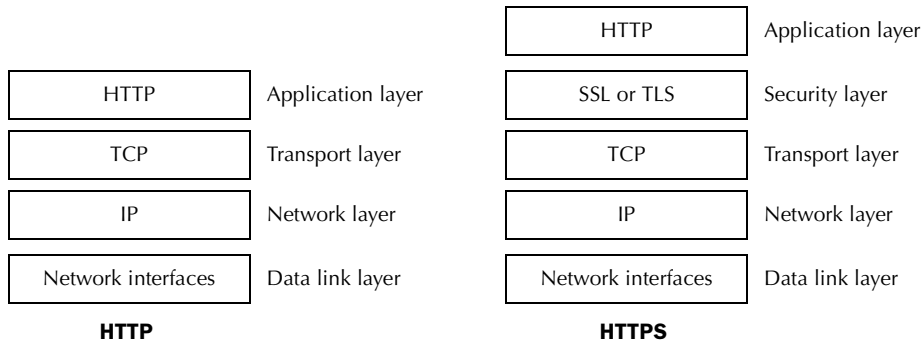

The URL typically determines whether the client application should use HTTP or HTTPS to contact a server:

- **http://servername.** The client application opens a connection to the server on port 80 by default and sends HTTP commands in plaintext.
- **https://servername.** The client application opens a connection to the server on port 443 by default and starts to engage in the SSL “handshake” to establish a secure connection between the client and server. Once the secure connection is established, the client application sends encrypted HTTP commands. For more information about the SSL handshake, see “SSL Handshake” on page 206.

SSL Handshake

The SSL “handshake” is a set of steps a client and server engage in using the SSL protocol to establish a secure connection between them. The client and server must complete the following steps before they can send and receive encrypted HTTP messages:

1. **Exchange protocol version numbers.** Both sides must verify they can communicate with compatible versions of SSL or TLS.
2. **Choose a cipher that each side knows.** First, the client advertises which ciphers it supports and requests the server to send its certificate. Then, the server chooses the strongest cipher from the list and sends the client the chosen cipher and its digital certificate.

3. **Authenticate the identity of each side.** Typically, only the server gets authenticated while the client remains unauthenticated. The client validates the server certificate. For more information about certificates and using them to authenticate servers, see “Digital Certificates” on page 208.
4. **Generate temporary symmetric keys to encrypt the channel for this session.** The client generates a session key (usually a random number), encrypts it with the server’s public key, and sends it to the server. The server decrypts the session key with its private key. Both sides compute a common master secret key that will be used for all future encryption and decryption until the connection closes.

DIGITAL CERTIFICATES

A digital certificate is an electronic document that identifies and describes an organization, and that has been verified and signed by a trusted organization. A digital certificate is similar in concept to an identification card, such as a driver's license or a passport. The trusted organization that signs the certificate is also known as a certificate authority.

Certificates allow a client to know that it is talking to the organization it thinks it is talking to. When a server certificate is signed by a well-known or trusted authority, the client can better assess how much it trusts the server.

X.509 is a standard example of a public key infrastructure (PKI). X.509 specifies standards for certificates and an algorithm for validating certification paths. The Web Security appliance uses the X.509 standard.

X.509 certificates contain the following information:

- Subject's identity, such as the name of a person, server, or organization
- Certificate validity period
- Certificate authority who is vouching for the certificate
- Digital signature of the certificate created by the certificate authority using its private key
- Public key of the subject

For an example digital certificate you can view from a web browser, see "Working with Root Certificates" on page 213.

Although anyone can create a digital certificate, not everyone can get a well-respected certificate authority to vouch for the certificate's information and sign the certificate with its private key. For more information about validating the certificate authority in a digital certificate, see "Validating Certificate Authorities" on page 208.

Validating Certificate Authorities

The X.509 standard allows certificate authorities to issue digital certificates that are signed by other certificate authorities. Due to this system, there is a hierarchy of certificate authorities in a tree structure.

The top-most certificate authorities in the tree structure are called root certificates. Root certificates are not signed by a separate certificate authority because they are at the top of the tree structure. Therefore, by definition, all root certificates are self-signed certificates. The certificate authority listed in the root certificate is the certificate creator.

All certificates below the root certificate inherit the trustworthiness of the root certificate. For example, if CertificateAuthorityABC is a trusted certificate authority and it signs the certificate for certificate authority CertificateAuthorityXYZ, then CertificateAuthorityXYZ is automatically a trusted certificate authority.

Figure 11-2 shows the certification path for a certificate viewed in a web browser.

Figure 11-2 Certification Path Example

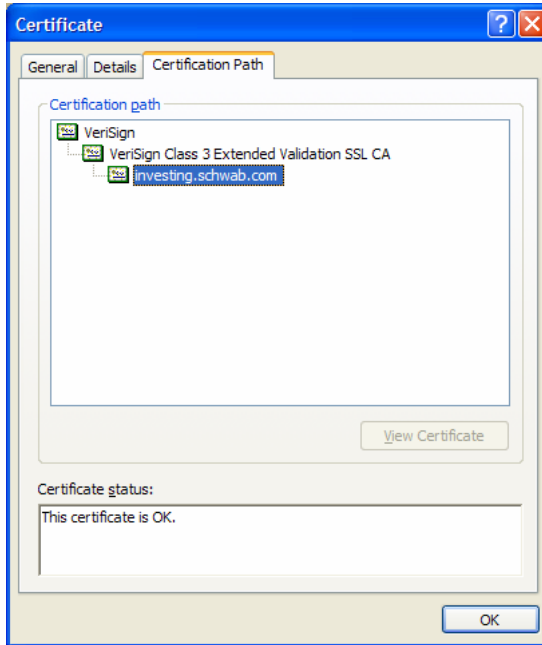

In Figure 11-2, the certificate for the URL `investing.schwab.com` was signed by certificate authority “VeriSign Class 3 Extended Validation SSL CA,” which in turn was signed by certificate authority VeriSign.

By definition, root certificates are always trusted by applications that follow the X.509 standard. The Web Security appliance uses the X.509 standard.

Standard web browsers ship with a set of trusted root certificates. The list of root certificates is updated regularly. You can view the root certificates installed on the web browser.

For example, to view the root certificates installed with Mozilla Firefox 2.0, go to Tools > Options > Advanced > Encryption > View Certificates. To view the root certificates installed with Internet Explorer 7, go to Tools > Internet Options > Content > Certificates > Trusted Root Certification Authorities.

In Figure 11-2, the VeriSign certificate is a root certificate that shipped with the web browser.

The Web Security appliance also installs with a set of trusted root certificates. However, you can upload additional root certificates that the Web Proxy deems to be trusted. For more information about this, see “Importing a Trusted Root Certificate” on page 231.

Validating Digital Certificates

Certificates can be valid or invalid. A certificate may be in invalid for different reasons. For example, the current time may be before or after the certificate validity period, the root authority in the certificate may not be recognized, or the Common Name of the certificate does not match the hostname specified in the HTTP “Host” header.

The Web Security appliance verifies that a server certificate is valid before it inspects and decrypts an HTTPS connection from a server. You can configure how the appliance handles connections to servers with invalid certificates. The appliance can perform one of the following actions for invalid server certificates:

- **Drop.** The appliance drops the connection and does not notify the client. This is the most restrictive option.
- **Decrypt.** The appliance allows the connection, but inspects the traffic content. It decrypts the traffic and applies Access Policies to the decrypted traffic as if it were a plaintext HTTP connection. For more information about how the appliance decrypts HTTPS traffic, see “Decrypting HTTPS Traffic” on page 211.
- **Monitor.** The appliance does not drop the connection, and instead it continues comparing the server request with the Decryption Policy groups. This is the least restrictive option.

Note — When an invalid server certificate is monitored, the errors in the certificate are maintained and passed along to the end-user.

For more information about configuring the appliance to handle invalid server certificates, see “Enabling the HTTPS Proxy” on page 217.

DECRYPTING HTTPS TRAFFIC

The request and response data is encrypted for HTTPS connections before it is sent across the network. Because the data is encrypted, third parties can view the data, but cannot decrypt it to read its contents without the private key of the HTTPS server.

Figure 11-3 shows an HTTPS connection between a client and a HTTPS server.

Figure 11-3 HTTPS Connection

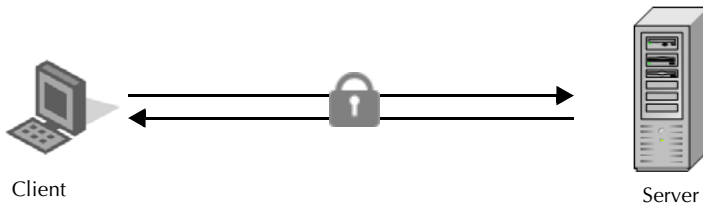

The Web Security appliance does not have access to the server's private key, so in order to inspect the traffic between the client and the server, it must intercept the connection and break the connection into two separate connections. The appliance acts as an intermediary between the client and the server pretending to be the server to the client, and the client to the server. This is sometimes referred to as being the "man in the middle."

Figure 11-4 shows an HTTPS connection between a client and a HTTPS server that goes through the Web Security appliance.

Figure 11-4 HTTPS Connection Decrypted by the Web Security Appliance



Notice that in Figure 11-4, there are two different HTTPS connections, one between the client and the appliance, and one between the appliance and the server. The appliance performs the SSL handshake twice, once with the client and again with the server:

- **SSL handshake with the server.** When the appliance performs the SSL handshake with the server, it acts as if it were the client sending a request to the server. After it establishes a secure connection with the server, it can begin receiving the encrypted data. Because it acts as the client and participates in the SSL handshake, it has agreed upon a temporary symmetric key with the server so it can decrypt and read the data the server sends. Also, the appliance receives the server's digital certificate.
- **SSL handshake with the client.** When the appliance performs the SSL handshake with the client, it acts as if it were the requested server providing data the client requests. In order

to perform the SSL handshake with the client, it must send the client its own digital certificate. However, the client expects the certificate of the requested server, so the appliance mimics the requested server's certificate by specifying a root certificate authority uploaded or configured by an appliance administrator.

For more information about how the server mimics the server's certificate, see "Mimicking the Server Digital Certificate" on page 212.

Note — Because the appliance signs the server certificate with a different root certificate authority and sends that to the client, you must verify the client applications on the network recognize the root certificate authority. For more information, see "Working with Root Certificates" on page 213.

After the two separate HTTPS connections are established, the following actions occur:

1. Encrypted data is received from the server.
2. The temporary, symmetric key negotiated with the server is used to decrypt the data.
3. Access Policies are applied to the decrypted traffic as if it were a plaintext HTTP connection. For more information about Access Policies, see "Access Policies" on page 169.
4. Assuming the Access Policy group allows the client to receive the data, the data is encrypted using the temporary, symmetric key negotiated with the client.
5. Encrypted data is sent to the client.

Note — No decrypted data is cached. However, access logs for decrypted HTTP transactions are saved to disk.

Mimicking the Server Digital Certificate

When the appliance performs the SSL handshake with the client, it mimics the server digital certificate and sends the new certificate to the client. To mimic the server digital certificate, it reuses most field values and changes some field values.

The mimicked certificate is the same as the server certificate except for the following fields:

- **Issuer.** The issuer comes from the generated or uploaded root certificate configured in the appliance.
- **Signature Algorithm.** This field is always "sha1WithRSAEncryption" or "dsaWithSHA1" depending upon on whether the root certificate the appliance uses contains an RSA or DSA key.
- **Public Key.** The appliance replaces the public key in the original certificate with a public key it generates that matches bit strength from the original certificate and for which it has a matching private key generated as well. For example, if the server certificate uses a 2048 bit RSA key, the appliance generates a new 2048 bit RSA key.
- **X509v3 Extensions.** All X509v3 extensions are removed *except* for the following:

- Basic Constraints
- Subject Alternative Name
- Key Usage
- Subject Key Identifier
- Extended Key Usage

For example, the appliance removes the Authority Key Identifier and the Authority Information Access X509v3 extensions.

Working with Root Certificates

The Web Security appliance mimics the HTTPS server to which a client originally sent a connection request. In order to establish a secure connection with the client pretending to be the requested server, the appliance must send a server certificate to the client signed by a root certificate authority configured in the appliance.

When you enable the HTTPS Proxy on the appliance, you can configure the root certificate information that the appliance uses to sign its server certificates. You can enter root certificate information in the following ways:

- **Generate.** You can enter some basic organization information and then click a button so the appliance generates the rest of the certificate and a matching key. You might want to generate a certificate and key when your organization does not have a certificate and key in use, or when it wants to create a new and unique certificate and key.
- **Upload.** You can upload a certificate file and its matching key file created outside of the appliance. You might want to upload a certificate and matching key file if the clients on the network already have the root certificates on their machines.
The certificate and key files you upload must be in PEM format. DER format is not supported. For more information about convert a DER formatted certificate or key to PEM format, see “Converting Certificate and Key Formats” on page 215.

Note — The certificate you upload must contain “basicConstraints=CA:TRUE” to work with Mozilla Firefox browsers. This constraint allows Firefox to recognize the root certificate as a trusted root authority.

For more information about how to generate or upload a certificate and key, see “Enabling the HTTPS Proxy” on page 217.

However, typically, the root certificate information you generate or upload in the appliance is not listed as a trusted root certificate authority in client applications. By default, when users send HTTPS requests, they will see a warning message from the client application informing them that there is a problem with the website’s security certificate. Usually, the error message says that the website’s security certificate was not issued by a trusted certificate authority or the website was certified by an unknown authority.

Note — You can also upload an intermediate certificate that has been signed by a root certificate authority. When the Web Proxy mimics the server certificate, it sends the uploaded

certificate along with the mimicked certificate to the client application. That way, as long as the intermediate certificate is signed by a root certificate authority that the client application trusts, the application will trust the mimicked server certificate, too. You might want to upload an intermediate certificate if your organization uses its own root certificate authority, but does not want to upload the root certificate to the Web Security appliance for security reasons.

Figure 11-5 on page 214 shows an example error message when a users sends an HTTPS request through Netscape Navigator.

Figure 11-5 Unknown Certificate Authority Error Message

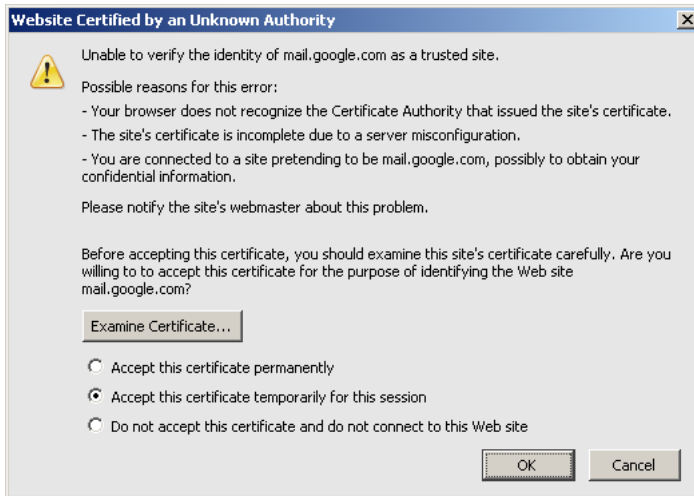

Typically, users can view the certificate and use the information in the certificate to choose whether or not to allow the secure connection with this website. In Figure 11-5, you can view the certificate contents by clicking **Examine Certificate**.

Figure 11-6 on page 215 shows an example root certificate issued by the appliance.

Figure 11-6 Certificate Issued by Web Security Appliance

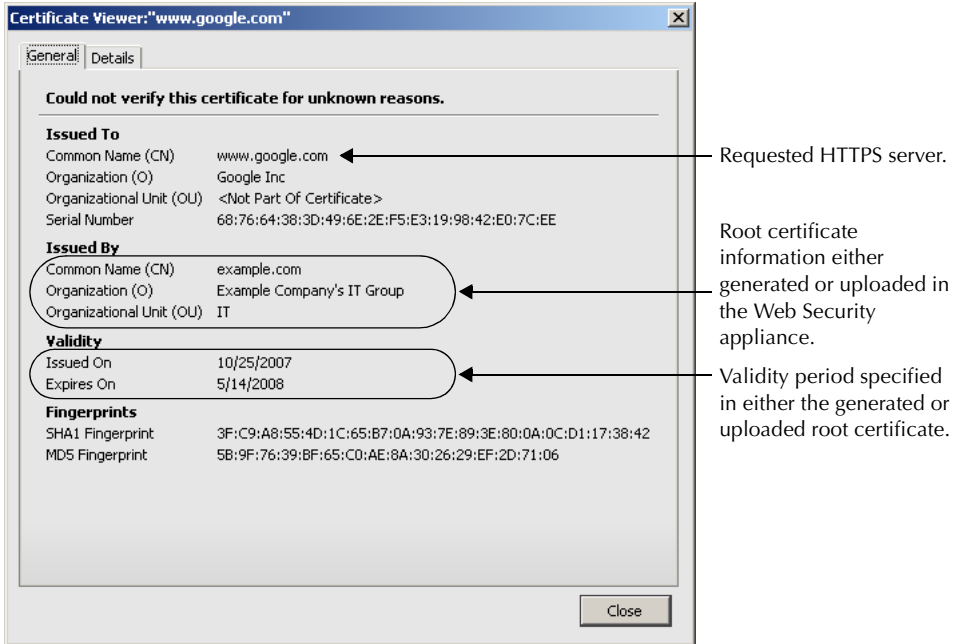

You can choose how to handle the root certificates issued by the Web Security appliance:

- **Inform users to accept the root certificate.** You can inform the users in your organization what the new policies are at the company and tell them to accept the root certificate supplied by the organization as a trusted source.
- **Add the root certificate to client machines.** You can add the root certificate to all client machines on the network as a trusted root certificate authority. This way, the client applications automatically accept transactions with the root certificate. To verify you distribute the root certificate the appliance is using, you can download the root certificate from the Security Services > HTTPS Proxy page. Click **Edit Settings**, and then click the Download Certificate link for either the generated or uploaded certificate.

You might want to download the root certificate from the appliance if a different person uploaded the root certificate to the appliance and you want to verify you distribute the same root certificate to the client machines.

Converting Certificate and Key Formats

The root certificate file and its matching key file you upload to the appliance must be in PEM format. DER format is not supported. However, you can convert certificates and keys in DER format into the PEM format before uploading them. For example, you can use OpenSSL to convert the format.

Use the following OpenSSL command to convert a DER formatted certificate file to a PEM formatted certificate file:

```
openssl x509 -inform DER -in cert_in_DER -outform PEM -out  
out_file_name
```

You can also convert key files in DER format into the PEM format by running a similar OpenSSL command.

For RSA keys, use the following command:

```
openssl rsa -inform DER -in key_in_DER -outform PEM -out out_file_name
```

For DSA keys, use the following command:

```
openssl dsa -inform DER -in key_in_DER -outform PEM -out out_file_name
```

For more information about using OpenSSL, see the OpenSSL documentation, or visit <http://openssl.org>.

ENABLING THE HTTPS PROXY

To monitor and decrypt HTTPS traffic, you must enable the HTTPS Proxy on the Security Services > HTTPS Proxy page. When you enable the HTTPS Proxy, you must configure what the appliance uses for a root certificate when it sends self-signed server certificates to the client applications on the network. You can upload a root certificate and key that your organization already has, or you can configure the appliance to generate a certificate and key with information you enter.

Note — When AsyncOS for Web runs on a FIPS-compliant Web Security appliance, you must use the FIPS management console to generate or upload the root certificate and key pair. When you generate or upload certificates and keys using the FIPS management console, the keys are protected by the HSM card. For more information on using the FIPS management console, see “FIPS Management” on page 67.

Once the HTTPS Proxy is enabled, all HTTPS policy decisions are handled by Decryption Policies. You can no longer define Access and Routing Policy group membership by HTTPS, nor can you configure Access Policies to block HTTPS transactions. If some Access and Routing Policy group memberships are defined by HTTPS and if some Access Policies block HTTPS, then when you enable the HTTPS Proxy those Access and Routing Policy groups become disabled. You can choose to enable the policies at any time, but all HTTPS related configurations are removed.

Note — When you upload a certificate to the Web Security appliance, verify it is a signing certificate and not a server certificate. A server certificate cannot be used as a signing certificate, so decryption does not work when you upload a server certificate.

For more information about root certificates, see “Working with Root Certificates” on page 213.

Also on this page, you can configure what the appliance does with HTTPS traffic when the server certificate is invalid.

Note — For information on importing a custom root authority certificate, see “Importing a Trusted Root Certificate” on page 231.

To enable the HTTPS Proxy:

1. Navigate to the Security Services > HTTPS Proxy page, and click **Enable and Edit Settings**.
The HTTPS Proxy License Agreement appears.
2. Read the terms of the HTTPS Proxy License Agreement, and click **Accept**.
The Edit HTTPS Proxy Settings page appears.

Edit HTTPS Proxy Settings

HTTPS Proxy Settings

Enable HTTPS Proxy

Transparent HTTPS Ports:

Root Certificate for Signing:

Use Generated Certificate and Key [Generate New Certificate and Key](#)

No certificate has been generated.

Use Uploaded Certificate and Key [Upload Files](#)

Certificate: [Browse...](#)

Key: [Browse...](#)

Private key must be unencrypted.

No certificate has been uploaded.

Invalid Certificate Handling:

	Drop	Decrypt	Monitor
Certificate Error	Select all	Select all	Select all
Expired			✓
Mismatched Hostname			✓
Unrecognized Root Authority			✓
All other error types			✓

No end-user notification will be provided for dropped HTTPS connections. Use this setting with caution. If the connection is not dropped, an equivalent certificate will be generated.

3. Verify the Enable HTTPS Proxy field is enabled.
4. Enter the ports the appliance should check for HTTPS traffic in the Transparent HTTPS Ports field. Port 443 is entered by default.

Note — This field only appears when the appliance is deployed in transparent mode.
5. Choose which root certificate to use for signing self-signed certificates the appliance sends to clients:
 - **Generated certificate and key.** Go to step 6 on page 218.
 - **Uploaded certificate and key.** Go to step 7 on page 219.

For more information about how the appliance uses these root certificates, see “Working with Root Certificates” on page 213.

Note — If the appliance has both an uploaded certificate and key pair and a generated certificate and key pair, it only uses the certificate and key pair currently selected in the Root Certificate for Signing section.

6. To generate a certificate and key:
 - a. Click the Use Generated Certificate and Key option.
 - b. Click **Generate New Certificate and Key**.

- c. In the Generate Certificate and Key dialog box, enter the information to display in the root certificate.

Note — You can enter any ASCII character except the forward slash (/) in the Common Name field.

- d. Click **Generate**. The Web Security appliance generates the certificate with the data you entered and generates a key.

The generated certificate information is displayed on the Edit HTTPS Proxy Settings page.

Note — After you generate the certificate and key, you can download the generated certificate to transfer it to the client applications on the network. Do this using the Download Certificate link in the generated key area.

- e. Go to step 8 on page 220.

7. To upload a root certificate and key:

- a. Click Use Uploaded Certificate and Key.
- b. Click **Browse** for the Certificate field to navigate to the certificate file stored on the local machine.

If the file you upload contains multiple certificates or keys, the Web Proxy uses the first certificate or key in the file.

Note — The certificate file must be in PEM format. DER format is not supported.

- c. Click **Browse** for the Key field to navigate to the private key file. The private key must be unencrypted.

Note — The key length must be 512, 1024, or 2048 bits. Also, the private key file must be in PEM format. DER format is not supported.

- d. Click **Upload Files** to transfer the certificate and key files to the Web Security appliance.

The uploaded certificate information is displayed on the Edit HTTPS Proxy Settings page.

Note — After you upload the certificate and key, you can download the certificate to transfer it to the client applications on the network. Do this using the Download Certificate link in the uploaded key area.

8. In the Invalid Certificate Handling section, choose how the appliance handle HTTPS traffic when it encounters invalid server certificates. You can drop, decrypt, or monitor HTTPS traffic for the following types of invalid server certificates:
 - **Expired.** The certificate is either not yet valid, or it is currently past its valid to date.
 - **Mismatched hostname.** The host name in the certificate does not match the host name the client was trying to access. This might happen during a “man in the middle attack,” or when a server redirects a request to a different URL. For example, `http://mail.google.com` gets redirected to `http://www.gmail.com`.

Note — The Web Proxy can only perform host name match when it is deployed in explicit forward mode. When it is deployed in transparent mode, it does not know the host name of the destination server (it only knows the IP address), so it cannot compare it to the host name in the server certificate.

- **Unrecognized root authority.** The root certificate authority for the certificate is not in the set of trusted root authorities on the appliance.
- **All other error types.** Most other error types are due to the appliance not being able to complete the SSL handshake with the HTTPS server. For more information about additional error scenarios for server certificates, see <http://www.openssl.org/docs/apps/verify.html>.

Note — When a certificate is both expired and has an unrecognized root authority, the Web Security appliance performs the action specified for an unrecognized root authority.

For more information about handling invalid server certificates, see “Validating Digital Certificates” on page 210.

9. Submit and commit your changes.

EVALUATING DECRYPTION POLICY GROUP MEMBERSHIP

After the Web Proxy assigns an Identity to a client request, it evaluates the request against the other policy types to determine which policy group it belongs for each type. When the HTTPS Proxy is enabled, it applies HTTPS requests against the Decryption Policies. When the HTTPS Proxy is not enabled, it evaluates HTTP requests against the Access Policies.

When an HTTPS request gets decrypted, the Web Proxy evaluates the decrypted request against the Access Policies. For more information about how the Web Proxy evaluates Access Policies, see “Evaluating Access Policy Group Membership” on page 172.

The Web Proxy applies the configured policy control settings to a client request based on the client request’s policy group membership.

To determine the policy group that a client request matches, the Web Proxy follows a very specific process for matching the group membership criteria. During this process, it considers the following factors for group membership:

- **Identity.** Each client request either matches an Identity, fails authentication and is granted guest access, or fails authentication and gets terminated. For more information about evaluating Identity group membership, see “Evaluating Identity Group Membership” on page 147.
- **Authorized users.** If the assigned Identity requires authentication, the user must be in the list of authorized users in the Decryption Policy group to match the policy group.
- **Advanced options.** You can configure several advanced options for Decryption Policy group membership. Some of the options (such as proxy port, and URL category) can also be defined within the Identity. When an advanced option is configured in the Identity, it is not configurable in the Decryption Policy group level.

The information in this section gives an overview of how the appliance matches client requests to Decryption Policy groups. For more details about exactly how the appliance matches client requests, see “Matching Client Requests to Decryption Policy Groups” on page 221.

The Web Proxy sequentially reads through each policy group in the policies table. It compares the client request status to the membership criteria of the first policy group. If they match, the Web Proxy applies the policy settings of that policy group.

If they do not match, the Web Proxy compares the client request to the next policy group. It continues this process until it matches the client request to a user defined policy group, or if it does not match a user defined policy group, it matches the global policy group. When the Web Proxy matches the client request to a policy group or the global policy group, it applies the policy settings of that policy group.

Matching Client Requests to Decryption Policy Groups

Figure 11-7 on page 222 shows how the Web Proxy evaluates a client request against the Decryption Policy groups.

Figure 11-7 Policy Group Flow Diagram for Decryption Policies

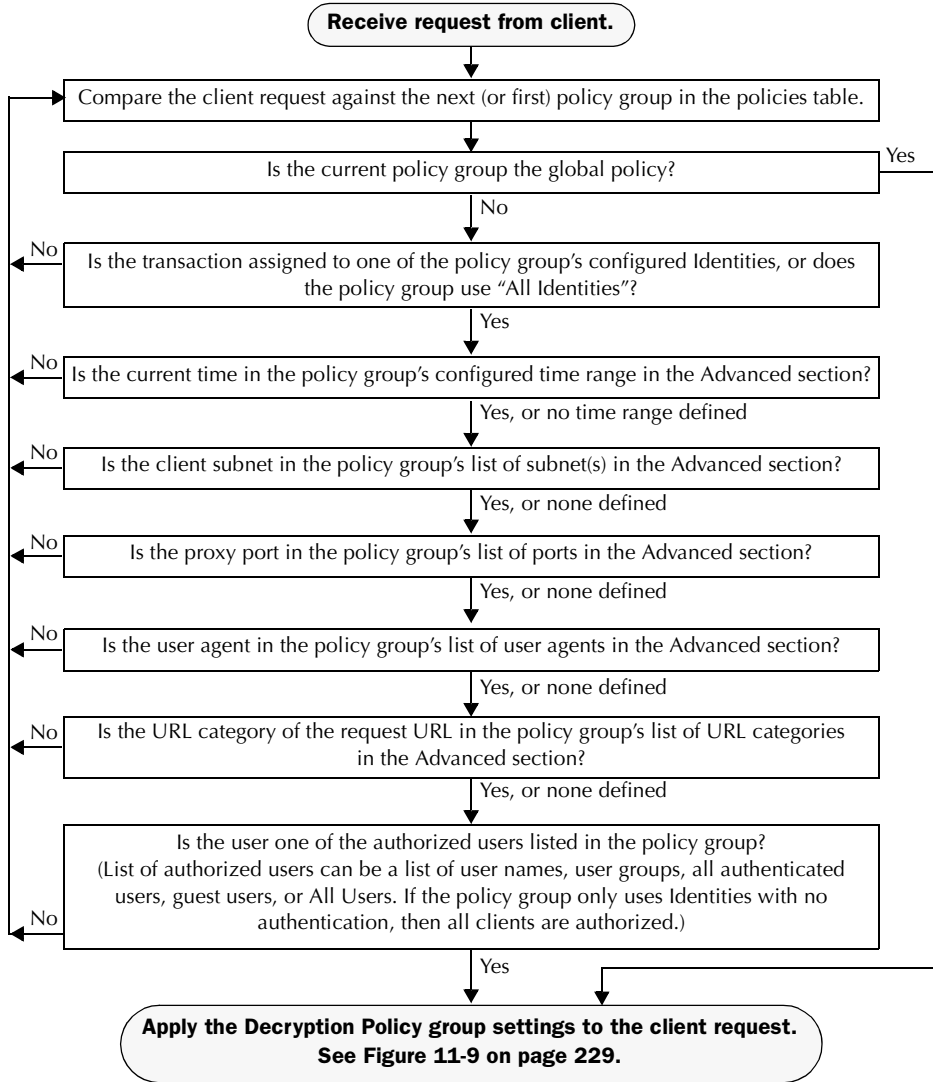

CREATING DECRYPTION POLICIES

You can create Decryption Policy groups based on combinations of several criteria, such as Identity or the URL category of the destination site. You must define at least one criterion for policy group membership. When you define multiple criteria, the client request must meet all criteria to match the policy group.

For more information about how the appliance matches a client request with a policy group, see “Evaluating Decryption Policy Group Membership” on page 221 and “Matching Client Requests to Decryption Policy Groups” on page 221.

You define policy group membership on the Web Security Manager > Decryption Policies page.

To create a Decryption Policy group:

1. Navigate to the Web Security Manager > Decryption Policies page.
2. Click **Add Policy**.
3. In the Policy Name field, enter a name for the policy group, and in the Description field, optionally add a description.
4. In the Insert Above Policy field, choose where in the policies table to place the policy group.

When configuring multiple policy groups you must specify a logical order for each group. Carefully order your policy groups to ensure that correct matching occurs.

5. In the Identities and Users section, choose one or more Identity groups to apply to this policy group.

Note — If the Identity requires authentication, then authentication information may not be available when a user tries to connect to an HTTPS server. For more information on how HTTPS and authentication work together, see “How Authentication Affects HTTPS and FTP over HTTP Requests” on page 149.

For more information on how to do this, see “Configuring Identities in Other Policy Groups” on page 162.

6. Optionally, expand the Advanced section to define additional membership requirements.

Policy Member Definition

Membership is defined by the combination of the following options. All criteria must be met for the policy to take effect.

Identities and Users:	<input type="text" value="Select One or More Identities"/>	
	<input type="text" value="Identity"/>	<input type="text" value="Authorized Users and Groups"/> <input type="button" value="Add Identity"/>
	<input type="text" value="Select Identity..."/>	<input type="text" value="No identity selected"/> <input type="button" value="X"/>

Advanced Use the Advanced options to define or edit membership by proxy port, subnet, Time Range, destination (URL Category), or User Agents.

The following advanced membership criteria have been defined:

Proxy Ports: [None Selected](#)

Subnets: [None Selected](#)

Time Range: [None Selected](#)

URL Categories: [None Selected](#)

User Agents: [None Selected](#)

- To define policy group membership by any of the advanced options, click the link for the advanced option and configure the option on the page that appears.

Table 11-2 describes the advanced options you can configure for Decryption Policy groups.

Table 11-2 Decryption Policy Group Advanced Options

Advanced Option	Description
Proxy Ports	<p>Choose whether or not to define policy group membership by the proxy port used to access the Web Proxy. Enter one or more port numbers in the Proxy Ports field. Separate multiple ports with commas.</p> <p>For explicit forward connections, this is the port configured in the browser. For transparent connections, this is the same as the destination port. You might want to define policy group membership on the proxy port if you have one set of clients configured to explicitly forward requests on one port, and another set of clients configured to explicitly forward requests on a different port.</p> <p>IronPort recommends only defining policy group membership by the proxy port when the appliance is deployed in explicit forward mode, or when clients explicitly forward requests to the appliance. When you define policy group membership by the proxy port when clients requests get transparently redirected to the appliance, some requests might be denied.</p> <p>Note: If the Identity associated with this policy group defines Identity membership by this advanced setting, the setting is not configurable at the non-Identity policy group level.</p>

Table 11-2 Decryption Policy Group Advanced Options (Continued)

Advanced Option	Description
Subnets	<p>Choose whether or not to define policy group membership by subnet or other addresses.</p> <p>You can choose to use the addresses that may be defined with the associated Identity, or you can enter specific addresses here.</p> <p>Note: If the Identity associated with this policy group defines its membership by addresses, then in this policy group you must enter addresses that are a subset of the Identity's addresses. Adding addresses in the policy group further narrows down the list of transactions that match this policy group.</p>
Time Range	<p>Choose whether or not to define policy group membership by a defined time range. Choose the time range from the Time Range field and then choose whether this policy group should apply to the times inside or outside the selected time range.</p> <p>For more information on creating time based policies, see "Working with Time Based Policies" on page 136.</p> <p>For more information on creating time ranges, see "Creating Time Ranges" on page 136.</p>
URL Categories	<p>Choose whether or not to define policy group membership by URL categories. Select the user defined or predefined URL categories.</p> <p>Note: If the Identity associated with this policy group defines Identity membership by this advanced setting, the setting is not configurable at the non-Identity policy group level.</p>
User Agents	<p>Choose whether or not to define policy group membership by the user agent used in the client request. You can select some commonly defined browsers, or define your own using regular expressions. Choose whether this policy group should apply to the selected user agents or to any user agent that is not in the list of selected user agents.</p> <p>For more information on creating user agent based policies, see "Working with User Agent Based Policies" on page 138.</p> <p>Note: If the Identity associated with this policy group defines Identity membership by this advanced setting, the setting is not configurable at the non-Identity policy group level.</p>

8. Submit your changes.
9. Configure Decryption Policy group control settings to define how the Web Proxy handles transactions.

The new policy group automatically inherits global policy group settings until you configure options for each control setting. For more information, see "Controlling HTTPS Traffic" on page 227.

10. Submit and commit your changes.

CONTROLLING HTTPS TRAFFIC

After the Web Security appliance assigns an HTTPS connection request to a Decryption Policy group, the connection request inherits the control settings of that policy group. The control settings of the Decryption Policy group determine whether the appliance allows, drops, or passes through the connection. For more information about the actions the appliance can take on an HTTPS request, see “Decryption Policy Groups” on page 201.

Configure control settings for Decryption Policy groups on the Web Security Manager > Decryption Policies page.

Figure 11-8 shows where you can configure control settings for the Decryption Policy groups.

Figure 11-8 HTTPS Policies Table

Decryption Policies

Policies					
Add Policy...					
Order	Group ?	URL Categories	Web Reputation	Default Action	Delete
1	DecryptWebEmail Identity: All URL Categories: Web-based E-mail	Pass Through: 0 Monitor: 0 Decrypt: 1 Drop: 0 Time-Based: 0	(global policy)	(global policy)	
	Global Policy Identity: All	Pass Through: 0 Monitor: 53 Decrypt: 0 Drop: 0	Enabled	Decrypt	

Authentication: Enabled Disabled Policy Disabled

(When enabled, authentication is applicable to forward connections and pre-established transparent IP-based credentials only.)

You can configure the following settings to determine what action to take on the HTTPS connection:

- **URL categories.** You can configure the action to take on HTTPS requests for each predefined and custom URL category. Click the link under the URL Categories column for the policy group you want to configure. For more information about working with URL filters, see “URL Filters” on page 287. For more information about configuring URL categories, see “Configuring URL Filters for Decryption Policy Groups” on page 295.

Note — If you want to *block* (with end-user notification) a particular URL category for HTTPS requests instead of drop (with no end-user notification), choose to decrypt that URL category in the Decryption Policy group and then choose to block the same URL category in the Access Policy group.

- **Web reputation.** You can configure the action to take on HTTPS requests based on the web reputation score of the requested server. Click the link under the Web Reputation column for the policy group you want to configure. For more information about working with web reputation scores, see “Web Reputation in Decryption Policies” on page 334.

- **Default action.** You can configure the action the appliance should take when none of the other settings apply. Click the link under the Default Action column for the policy group you want to configure.

Note — The configured default action only affects the transaction when no decision is made based on URL category or Web Reputation score. If Web Reputation filtering is disabled, the default action applies to all transactions that match a Monitor action in a URL category. If Web Reputation filtering is enabled, the default action is used only if the Monitor action is selected for sites with no score.

After a Decryption Policy group is assigned to an HTTPS request, the control settings for the policy group are evaluated to determine whether to drop, pass through, or decrypt the HTTPS connection request. For more information about assigning a Decryption Policy group to an HTTPS request, see “Policy Group Membership” on page 133.

Figure 11-9 on page 229 shows how the appliance determines which action to take on an HTTPS request after it has assigned a particular Decryption Policy to the request.

Figure 11-9 Applying Decryption Policy Actions

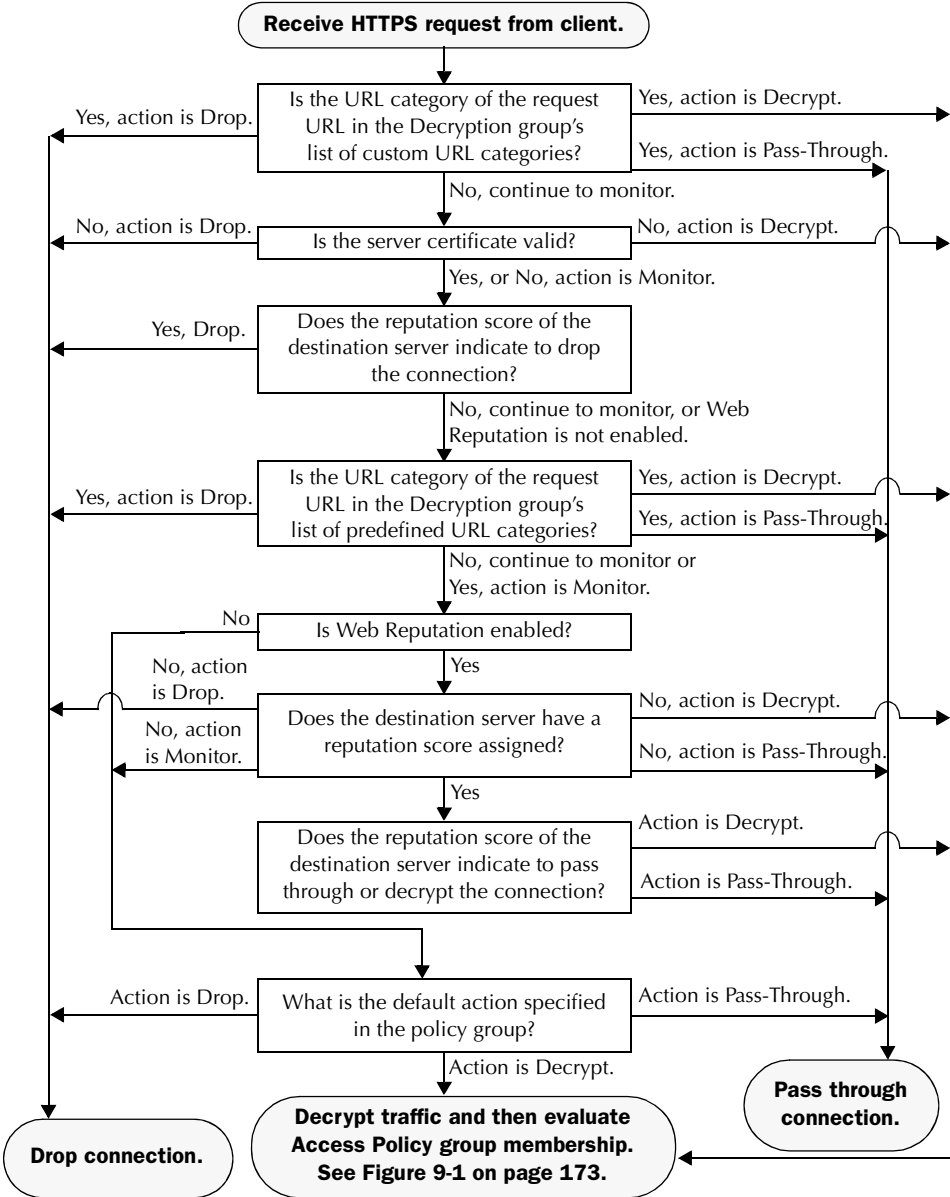

Figure 11-9 shows two different decision points that involve the web reputation score of the destination server. The web reputation score of the server is evaluated only once, but the result is applied at two different points in the decision flow.

For example, note that a web reputation score drop action overrides any action defined for predefined URL categories.

Note — The configured default action only affects the action on the HTTPS request when web reputation filtering is not enabled, or when it is enabled and the server has no score assigned and the action for servers with no scores is to Monitor.

IMPORTING A TRUSTED ROOT CERTIFICATE

When the Web Proxy receives a connection request for an HTTPS server, it validates the trustworthiness of the destination server by verifying the root certificate authority that signed the server certificate. If the Web Proxy does not recognize the root certificate that signed the server certificate, then it does not trust the server certificate. This happens when the HTTPS server uses a certificate authority that is not listed in the set of trusted certificate authorities that ship with the Web Security appliance. This might happen if your organization uses an internal certificate authority to sign certificates for servers on the internal network.

To prevent the Web Proxy from potentially blocking access to servers with unrecognized root certificate authorities, you can upload to the appliance root certificates that your organization trusts. For example, you might want to upload a root certificate used by the servers on your network.

You can upload multiple root certificate files to the appliance, and each file you upload can contain multiple root certificates. However, each certificate you upload must be a root certificate.

To import a trusted root certificate:

1. Navigate to the Security Services > HTTPS Proxy page.



2. In the Custom Root Authority Certificates section, click **Import**.

Import Custom Root Authority Certificate File



3. In the Import Custom Root Authority Certificate File, click **Browse**.
4. Navigate to the location where the custom root authority certificate file is located and click **Open**.
5. Click **Submit**.
The uploaded root certificate is displayed in the "Custom Root Authority Certificates" section.
6. Optionally, repeat steps 2 through 5 to upload additional trusted root certificates.
7. Commit your changes.

Data Security and External DLP Policies

This chapter contains the following information:

- “Data Security and External DLP Policies Overview” on page 234
- “Working with Data Security and External DLP Policies” on page 236
- “Evaluating Data Security and External DLP Policy Group Membership” on page 239
- “Creating Data Security and External DLP Policies” on page 241
- “Controlling Upload Requests Using IronPort Data Security Policies” on page 245
- “Defining External DLP Systems” on page 249
- “Controlling Upload Requests Using External DLP Policies” on page 252
- “Logging” on page 254

DATA SECURITY AND EXTERNAL DLP POLICIES OVERVIEW

In the Information Age, your organization's data is one of its most prized possessions. Your organization spends a lot of money making data available to your employees, customers, and partners. Data is always on the move by traveling over the web and email. This increased access poses challenges for information security professionals to figure out how to prevent the malicious, accidental, or unintentional loss of sensitive and proprietary information.

The IronPort Web Security appliance secures your data by providing the following capabilities:

- **IronPort Data Security Filters.** The IronPort Data Security Filters on the Web Security appliance evaluate data leaving the network over HTTP, HTTPS, and FTP to control what data goes where and how and by whom.
- **Third party data loss prevention (DLP) integration.** The Web Security appliance integrates with leading third party content-aware DLP systems that identify and protect sensitive data. The Web Proxy uses the Internet Content Adaptation Protocol (ICAP) which is a lightweight HTTP based protocol that allows proxy servers to offload content scanning to external systems. By offloading the content scanning to dedicated external systems, the Web Proxy can take advantage of the deep content scanning in other products while being free to perform other Web Proxy functions with minimal performance impact.

By working with the IronPort Data Security Filters and external DLP systems, the Web Security appliance allows you to protect information and intellectual property and enforce regulatory and organization compliance by preventing users from unintentionally uploading sensitive data. You define what kind of data is allowed to leave the network.

To restrict data that is leaving the network, the Web Security appliance provides the following types of policy groups:

- **IronPort Data Security Policies.** When you enable the IronPort Data Security Filters, you can create IronPort Data Security Policies to enforce business policies. For example, you can create a Data Security Policy that prevents users from sending out Excel or zip files. For more information, see "Data Security Policy Groups" on page 236.
- **External DLP Policies.** When you configure the appliance to work with an external DLP system, you can create External DLP Policies to pass data leaving the network to the external DLP system which scans the content and determines whether or not to block the request. For more information, see "External DLP Policy Groups" on page 237.

Depending on your organization's needs, you might want to use both Data Security and External DLP Policies. For example, you might use the IronPort Data Security Policies to block data uploads to websites with a low reputation score. This way, the data is never sent to the external DLP system for a deep content scan, which improves overall performance.

Bypassing Upload Requests Below a Minimum Size

Many websites are interactive, meaning users send data as well as receive data. Users might send data when logging into a website or sending simple form data. A lot of web traffic can

consist of relatively small POST requests that are harmless, but can take up many lines in the log files. This creates a lot of “noise” in the logs that can make it difficult to find and troubleshoot the true data security violations, such as users uploading company files using their personal email account.

To help reduce the number of upload requests recorded in the log files, you can define a minimum request body size, below which upload requests are not scanned by the IronPort Data Security Filters or the external DLP server.

To do this, use the following CLI commands:

- **datasecurityconfig**. Applies to the IronPort Data Security Filters.
- **externaldlpconfig**. Applies to the configured external DLP servers.

The default minimum request body size is 4 KB (4096 bytes) for both CLI commands. Valid values are 1 to 64 KB. The size you specify applies to the entire size of the upload request body.

Note — All chunk encoded uploads and all native FTP transactions are scanned by the IronPort Data Security Filters or external DLP servers when enabled. However, they can still be bypassed based on a custom URL category. For more information, see Figure 12-3 on page 246.

User Experience with Blocked Requests

When the IronPort Data Security Filters or an external DLP server blocks an upload request, it provides a block page that the Web Proxy sends to the end user. However, not all websites display the block page to the end user. For example, some Web 2.0 websites display dynamic content using javascript instead of a static webpage and are not likely to display the block page. Users are still properly blocked from performing data security violations, but they may not always be informed of this by the website.

WORKING WITH DATA SECURITY AND EXTERNAL DLP POLICIES

IronPort Data Security Policies and External DLP Policies define how the Web Proxy handles HTTP requests and decrypted HTTPS connections for transactions that upload data to a server (upload requests). However, IronPort Data Security Policies use logic defined on the Web Security appliance and External DLP Policies use logic defined on the DLP system. An upload request is an HTTP or decrypted HTTPS request that has content in the request body.

When the Web Proxy receives an upload request, it compares the request to the Data Security and External DLP Policy groups to determine which policy group to apply. If both types of policies are configured, it compares the request to IronPort Data Security Policies before external DLP Policies. After it assigns the request to a policy group, it compares the request to the policy group's configured control settings to determine what to do with the request.

How you configure the appliance to handle upload requests depends on the policy group type. For more information, see “Data Security Policy Groups” on page 236 and “External DLP Policy Groups” on page 237.

Note — Upload requests that try to upload files with a size of zero (0) bytes are not evaluated against IronPort Data Security or External DLP Policies.

Data Security Policy Groups

To configure the Web Security appliance to handle upload requests on the appliance itself, perform the following tasks:

1. **Enable the IronPort Data Security Filters.** To scan upload requests on the appliance, you must first enable the IronPort Data Security Filters. Usually, the IronPort Data Security Filters feature is enabled during the initial setup using the System Setup Wizard. Otherwise, go to the Security Services > Data Security Filters page to enable it.
2. **Create and configure Data Security Policy groups.** After the IronPort Data Security Filters feature is enabled, you create and configure Data Security Policy groups to determine how to handle upload requests from each user.

IronPort Data Security Policies use URL filtering, web reputation, and upload content information when evaluating the upload request. You configure each of these security components to determine whether or not to block the upload request. For more information about the security components that you can configure and how the Web Proxy uses Data Security Policy groups to control upload requests, see “Controlling Upload Requests Using IronPort Data Security Policies” on page 245.

When the Web Proxy compares an upload request to the control settings, it evaluates the settings in order. Each control setting can be configured to perform one of the following actions for IronPort Data Security Policies:

- **Block.** The Web Proxy does not permit the connection and instead displays an end user notification page explaining the reason for the block.

- **Allow.** The Web Proxy bypasses the rest of the Data Security Policy security service scanning and then evaluates the request against the Access Policies before taking a final action.

For IronPort Data Security Policies, Allow bypasses the rest of data security scanning, but does not bypass External DLP or Access Policy scanning. The final action the Web Proxy takes on the request is determined by the applicable Access Policy (or an applicable external DLP Policy that may block the request).

- **Monitor.** The Web Proxy continues comparing the transaction to the other Data Security Policy group control settings to determine whether to block the transaction or evaluate it against the Access Policies.

For IronPort Data Security Policies, only the Block action is a final action that the Web Proxy takes on a client request. A final action is an action that causes the Web Proxy to stop comparing the transaction to all other control settings. The Monitor and Allow actions are intermediary actions. In both cases, the Web Proxy evaluates the transaction against the External DLP Policies (if configured) and Access Policies. The Web Proxy determines which final action to apply based on the Access Policy group control settings (or an applicable external DLP Policy that may block the request).

Figure 12-3 on page 246 shows the order that the Web Proxy uses when evaluating control settings for IronPort Data Security Policies. The flow diagram shows that the only actions applied to a transaction are the final actions: Block and evaluate against the Access Policies.

For more information on the possible Access Policy actions, see “Access Policy Groups” on page 170. For more information on the Monitor action for Access Policies, see “Understanding the Monitor Action” on page 171.

External DLP Policy Groups

To configure the Web Security appliance to handle upload requests on an external DLP system, perform the following tasks:

1. **Define an external DLP system.** To pass an upload request to an external DLP system for scanning, you must define at least one ICAP-compliant DLP system on the Web Security appliance. Do this on the Network > External DLP Servers page. For more information, see “Defining External DLP Systems” on page 249.
2. **Create and configure External DLP Policy groups.** After an external DLP system is defined, you create and configure External DLP Policy groups to determine which upload requests to send to the DLP system for scanning.

When an upload request matches an External DLP Policy, the Web Proxy sends the upload request to the DLP system using the Internet Content Adaptation Protocol (ICAP) for scanning. The DLP system scans the request body content and returns a block or allow verdict to the Web Proxy. The allow verdict is similar to the Allow action for IronPort Data Security Policies in that the upload request will be compared to the Access Policies. The final action the Web Proxy takes on the request is determined by the applicable Access Policy.

For more information about configuring External DLP Policy groups, see “Controlling Upload Requests Using External DLP Policies” on page 252.

EVALUATING DATA SECURITY AND EXTERNAL DLP POLICY GROUP MEMBERSHIP

Each client request is assigned to an Identity and then is evaluated against the other policy types to determine which policy group it belongs for each type. The Web Proxy evaluates *upload requests* against the Data Security and External DLP Policies.

The Web Proxy applies the configured policy control settings to a client request based on the client request's policy group membership.

To determine the policy group that a client request matches, the Web Proxy follows a very specific process for matching the group membership criteria. During this process, it considers the following factors for group membership:

- **Identity.** Each client request either matches an Identity, fails authentication and is granted guest access, or fails authentication and gets terminated. For more information about evaluating Identity group membership, see “Evaluating Identity Group Membership” on page 147.
- **Authorized users.** If the assigned Identity requires authentication, the user must be in the list of authorized users in the Data Security or External DLP Policy group to match the policy group. The list of authorized users can be any of the specified groups or users or guest users if the Identity allows guest access.
- **Advanced options.** You can configure several advanced options for Data Security and External DLP Policy group membership. Some of the options (such as proxy port, and URL category) can also be defined within the Identity. When an advanced option is configured in the Identity, it is not configurable in the Data Security or External DLP Policy group level.

The information in this section gives an overview of how the Web Proxy matches upload requests to both Data Security and External DLP Policy groups. For more details about exactly how the Web Proxy matches client requests, see “Matching Client Requests to Data Security and External DLP Policy Groups” on page 239.

The Web Proxy sequentially reads through each policy group in the policies table. It compares the upload request status to the membership criteria of the first policy group. If they match, the Web Proxy applies the policy settings of that policy group.

If they do not match, the Web Proxy compares the upload request to the next policy group. It continues this process until it matches the upload request to a user defined policy group, or if it does not match a user defined policy group, it matches the global policy group. When the Web Proxy matches the upload request to a policy group or the global policy group, it applies the policy settings of that policy group.

Matching Client Requests to Data Security and External DLP Policy Groups

Figure 12-1 on page 240 shows how the Web Proxy evaluates an upload request against the Data Security and External DLP Policy groups.

Figure 12-1 Policy Group Flow Diagram for Data Security and External DLP Policies

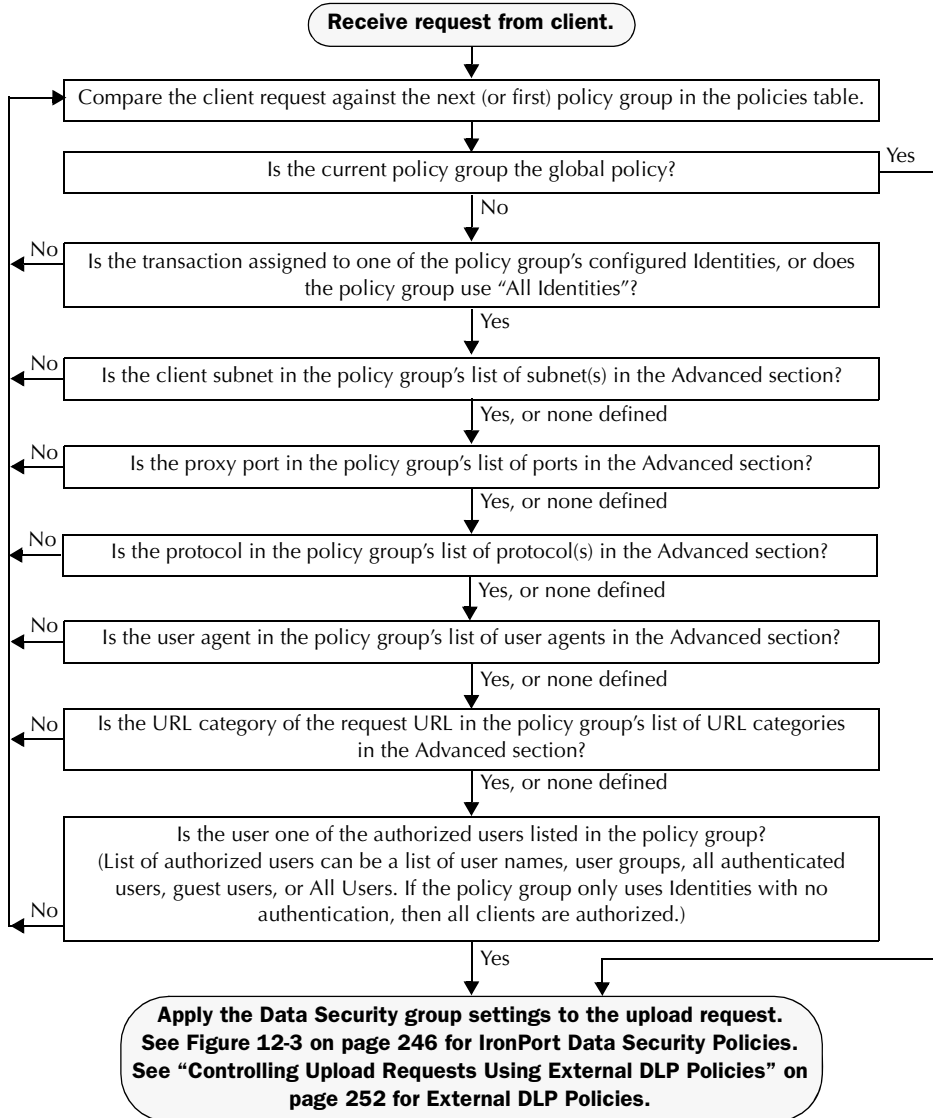

CREATING DATA SECURITY AND EXTERNAL DLP POLICIES

You can create Data Security and External DLP Policy groups based on combinations of several criteria, such as one or more Identities or the URL category of the destination site. You must define at least one criterion for policy group membership. When you define multiple criteria, the upload request must meet all criteria to match the policy group. However, the upload request needs to match only one of the configured Identities.

For more information about how the Web Proxy matches an upload request with a policy group, see “Evaluating Data Security and External DLP Policy Group Membership” on page 239 and “Matching Client Requests to Data Security and External DLP Policy Groups” on page 239.

Define Data Security Policy group membership on the Web Security Manager > IronPort Data Security Policies page. Define External DLP Policy group membership on the Web Security Manager > External DLP Policies page.

To create a Data Security or External DLP Policy group:

1. Navigate to the Web Security Manager > IronPort Data Security Policies page or the Web Security Manager > External DLP Policies page.
2. Click **Add Policy**.
3. In the Policy Name field, enter a name for the policy group, and in the Description field, optionally add a description.
4. In the Insert Above Policy field, choose where in the policies table to place the policy group.

When configuring multiple policy groups you must specify a logical order for each group. Carefully order your policy groups to ensure that correct matching occurs.

5. In the Identities and Users section, choose one or more Identity groups to apply to this policy group.

For more information on how to do this, see “Configuring Identities in Other Policy Groups” on page 162.

6. Optionally, expand the Advanced section to define additional membership requirements.

Policy Member Definition

Membership is defined by the combination of the following options. All criteria must be met for the policy to take effect.

Identities and Users:	<input type="button" value="Select One or More Identities"/>		
	<input type="text" value="Identity"/>	<input type="text" value="Authorized Users and Groups"/>	<input type="button" value="Add Identity"/>
	<input type="button" value="Select Identity..."/>	<input type="text" value="No identity selected"/>	<input type="button" value="Remove"/>

Advanced

Use the Advanced options to define or edit membership by protocol, proxy port, subnet, destination (URL Category), or User Agents.

The following advanced membership criteria have been defined:

Protocols: [None Selected](#)

Proxy Ports: [None Selected](#)

Subnets: [None Selected](#)

URL Categories: [None Selected](#)

User Agents: [None Selected](#)

- To define policy group membership by any of the advanced options, click the link for the advanced option and configure the option on the page that appears.

Table 12-1 describes the advanced options you can configure for Data Security and External DLP Policy groups.

Table 12-1 Data Security and External DLP Policy Group Advanced Options

Advanced Option	Description
Protocols	<p>Choose whether or not to define policy group membership by the protocol used in the client request. Select the protocols to include. "All others" means any protocol not listed above this option.</p> <p>Note: When the HTTPS Proxy is enabled, only Decryption Policies apply to HTTPS transactions. You cannot define policy membership by the HTTPS protocol for Access, Routing, Data Security, or External DLP Policies.</p>

Table 12-1 Data Security and External DLP Policy Group Advanced Options (Continued)

Advanced Option	Description
Proxy Ports	<p>Choose whether or not to define policy group membership by the proxy port used to access the Web Proxy. Enter one or more port numbers in the Proxy Ports field. Separate multiple ports with commas.</p> <p>For explicit forward connections, this is the port configured in the browser. For transparent connections, this is the same as the destination port. You might want to define policy group membership on the proxy port if you have one set of clients configured to explicitly forward requests on one port, and another set of clients configured to explicitly forward requests on a different port.</p> <p>IronPort recommends only defining policy group membership by the proxy port when the appliance is deployed in explicit forward mode, or when clients explicitly forward requests to the appliance. When you define policy group membership by the proxy port when client requests get transparently redirected to the appliance, some requests might be denied.</p> <p>Note: If the Identity associated with this policy group defines Identity membership by this advanced setting, the setting is not configurable at the non-Identity policy group level.</p>
Subnets	<p>Choose whether or not to define policy group membership by subnet or other addresses.</p> <p>You can choose to use the addresses that may be defined with the associated Identity, or you can enter specific addresses here.</p> <p>Note: If the Identity associated with this policy group defines its membership by addresses, then in this policy group you must enter addresses that are a subset of the addresses defined in the Identity. Adding addresses in the policy group further narrows down the list of transactions that match this policy group.</p>
URL Categories	<p>Choose whether or not to define policy group membership by URL categories. Select the user defined or predefined URL categories.</p> <p>Note: If the Identity associated with this policy group defines Identity membership by this advanced setting, the setting is not configurable at the non-Identity policy group level.</p>

Table 12-1 Data Security and External DLP Policy Group Advanced Options (Continued)

Advanced Option	Description
User Agents	<p>Choose whether or not to define policy group membership by the user agent used in the client request. You can select some commonly defined browsers, or define your own using regular expressions. Choose whether this policy group should apply to the selected user agents or to any user agent that is not in the list of selected user agents.</p> <p>For more information on creating user agent based policies, see “Working with User Agent Based Policies” on page 138.</p> <p>Note: If the Identity associated with this policy group defines Identity membership by this advanced setting, the setting is not configurable at the non-Identity policy group level.</p>

8. Submit your changes.
9. If you are creating a Data Security Policy group, configure its control settings to define how the Web Proxy handles upload requests.

The new Data Security Policy group automatically inherits global policy group settings until you configure options for each control setting. For more information, see “Controlling Upload Requests Using IronPort Data Security Policies” on page 245.
10. If you are creating an External DLP Policy group, configure its control settings to define how the Web Proxy handles upload requests.

The new External DLP Policy group automatically inherits global policy group settings until you configure custom settings. For more information, see “Controlling Upload Requests Using External DLP Policies” on page 252.
11. Submit and commit your changes.

CONTROLLING UPLOAD REQUESTS USING IRONPORT DATA SECURITY POLICIES

Each upload request is assigned to a Data Security Policy group and inherits the control settings of that policy group. The control settings of the Data Security Policy group determine whether the appliance blocks the connection or evaluates it against the Access Policies.

Configure control settings for Data Security Policy groups on the Web Security Manager > IronPort Data Security Policies page.

Figure 12-2 shows where you can configure control settings for the Data Security Policy groups.

Figure 12-2 Creating Secure IronPort Data Security Policies

Data Transfer Policies

Data Transfer Policies					
<input type="button" value="Add Policy..."/>					
Order	Data Transfer Policy	URL Categories	Web Reputation	Content	Delete
1	exampleDataTransferPolicy Identity: NTLMUsers	(global policy)	(global policy)	(global policy)	
	Global Policy Identity: All	Allow: 0 Monitor: 53 Block: 0	Enabled	No maximum size for HTTP/HTTPS No maximum size for FTP	

Authentication: Enabled Disabled

You can configure the following settings to determine what action to take on upload requests:

- **URL Categories.** For more information, see “URL Categories” on page 246.
- **Web Reputation.** For more information, see “Web Reputation” on page 247.
- **Content.** For more information, see “Content Blocking” on page 247.

After a Data Security Policy group is assigned to an upload request, the control settings for the policy group are evaluated to determine whether to block the request or evaluate it against the Access Policies. For more information about assigning a Data Security Policy group to an upload request, see “Policy Group Membership” on page 133.

Figure 12-3 on page 246 shows how the appliance determines which action to take on an upload request after it has assigned a particular Data Security Policy to the request.

Figure 12-3 Applying Data Security Policy Actions

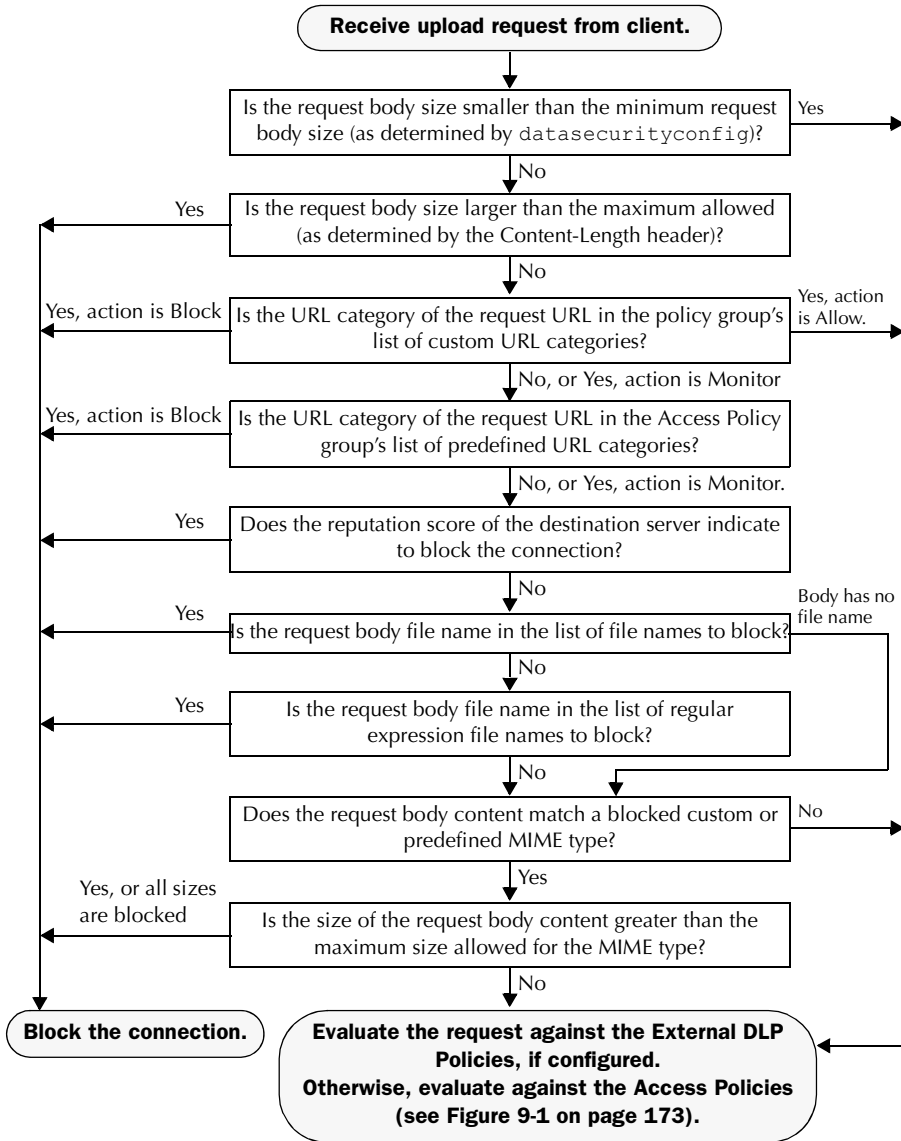

URL Categories

AsyncOS for Web allows you to configure how the appliance handles a transaction based on the URL category of a particular request. Using a predefined category list, you can choose to

monitor or block content by category. You can also create custom URL categories and choose to allow, monitor, or block traffic for a website in the custom category.

For more information about working with URL categories, see “Configuring URL Filters for Data Security Policy Groups” on page 297.

Web Reputation

The Web Reputation setting inherits the global setting. To customize web reputation filtering for a particular policy group, you can use the Web Reputation Settings pull-down menu to customize web reputation score thresholds.

Only negative and zero values can be configured for web reputation threshold settings for IronPort Data Security Policies. By definition, all positive scores are monitored.

For more information about configuring web reputation scores, see “Configuring Web Reputation Scores” on page 335.

Content Blocking

You can use the settings on the IronPort Data Security Policies > Content page to configure the Web Proxy to block data uploads based on the following file characteristics:

- **File size.** You can specify the maximum *upload* size allowed. All uploads with sizes equal to or greater than the specified maximum are blocked. You can specify different maximum file sizes for HTTP/HTTPS and native FTP requests.

When the upload request size is greater than both the maximum upload size and the maximum scan size (configured in the “Object Scanning Limits” field on Security Services > Anti-Malware page), the upload request is still blocked, but the entry in the data security logs does not record the file name and content type. The entry in the access logs is unchanged.

- **File type.** You can block predefined file types or custom MIME types you enter. When you block a predefined file type, you can block all files of that type or files greater than a specified size. When you block a file type by size, the maximum file size you can specify is the same as the value for the “Object Scanning Limits” field on Security Services > Anti-Malware page. By default, that value is 32 MB.

IronPort Data Security Filters do not inspect the contents of archived files when blocking by file type. Archived files can be blocked by its file type or file name, not according to its contents.

Note — For some groups of MIME types, blocking one type blocks all MIME types in the group. For example, blocking `application/x-java-applet` blocks all java MIME types, such as `application/java` and `application/javascript`.

- **File name.** You can block files with specified names. You can use text as a literal string or a regular expression for specifying file names to block. For more information on using regular expressions, see “Regular Expressions” on page 310.

Note — Only enter file names with 8-bit ASCII characters. The Web Proxy only matches file names with 8-bit ASCII characters.

Figure 12-4 on page 248 shows the IronPort Data Security Policies > Content page where you configure the content control settings.

Figure 12-4 IronPort Data Security Policies Content Settings

IronPort Data Security Policies: Content: IDSPolicy1

Edit Content Settings

Define Custom Objects Blocking Settings ▼

File Size

HTTP/HTTPS Maximum File Size:	<input type="text" value="0"/> <input type="text" value="MB"/> No Maximum
FTP Maximum File Size:	<input type="text" value="0"/> <input type="text" value="MB"/> No Maximum

Block File Types

[File and MIME Type Reference](#)

▶ Archives

▶ Document Types

▼ Executable Code

<input type="checkbox"/> ActiveX Plugin	Block all files of this type <input type="text" value=""/> <input type="text" value="KB"/>
<input type="checkbox"/> Windows Executable	Block all files of this type <input type="text" value=""/> <input type="text" value="KB"/>
<input type="checkbox"/> Java Program	Block all files of this type <input type="text" value=""/> <input type="text" value="KB"/>
<input type="checkbox"/> UNIX Executable	Block all files of this type <input type="text" value=""/> <input type="text" value="KB"/>
<input type="checkbox"/> Mozilla/Firefox Extension	Block all files of this type <input type="text" value=""/> <input type="text" value="KB"/>

▶ Installers

▶ Media

▶ P2P Metafiles

▶ Web Page Content

Custom MIME Types

[File and MIME Type Reference](#)

Custom MIME Types:

(Enter multiple entries on separate lines. Example: audio/x-mpeg3 or audio/* are valid entries.)

File Names

File Names to Block:

(Enter multiple entries on separate lines. Example: document.doc or spreadsheet.xls are valid entries. File names are not case sensitive.)

▶ Advanced
Match specific file names by regular expressions.

DEFINING EXTERNAL DLP SYSTEMS

The Web Security appliance can integrate with multiple external DLP servers from the same vendor by defining multiple DLP servers in the appliance. Define DLP systems and global settings that affect integration with all DLP systems on the Network > External DLP Servers page.

Figure 12-5 Network > External DLP Servers Page

External DLP Servers

External Data Loss Prevention Servers	
External DLP Servers:	dpl.example.com: 1344, icap://dpl.example.com
Load Balancing:	Fewest Connections
Service Request Timeout:	60 seconds
Maximum Connections Per Server:	25
Failure Handling:	Permit all data transfers to proceed without scanning
Edit Settings...	

You can define the load balancing technique the Web Proxy uses when contacting the DLP systems. This is useful when you define multiple DLP systems. For example, the Web Proxy can contact each DLP system using round-robin or a hash function.

To configure an external DLP server:

1. Navigate to the Network > External DLP Servers page.
2. Click **Edit Settings**.

Figure 12-6 Configuring External DLP Servers

Edit External DLP Servers

External Data Loss Prevention Servers																									
External DLP Servers:	<div style="border: 1px solid #ccc; padding: 5px;"> <table border="1" style="width: 100%; border-collapse: collapse;"> <thead> <tr> <th style="width: 60%;">Server</th> <th style="width: 15%;">Port</th> <th style="width: 15%;">Reconnection Attempts</th> <th style="width: 10%;"></th> </tr> </thead> <tbody> <tr> <td>dpl.example.com</td> <td>1344</td> <td>3</td> <td style="text-align: center;">✖</td> </tr> </tbody> </table> <div style="margin-top: 5px;"> <input type="button" value="Add Row"/> </div> </div>	Server	Port	Reconnection Attempts		dpl.example.com	1344	3	✖																
Server	Port	Reconnection Attempts																							
dpl.example.com	1344	3	✖																						
	<div style="border: 1px solid #ccc; padding: 5px;"> <table style="width: 100%; border-collapse: collapse;"> <tr> <td style="width: 60%;">Server Address</td> <td style="width: 15%;">Port</td> <td style="width: 15%;">Reconnection Attempts</td> <td style="width: 10%;"></td> </tr> <tr> <td><input type="text" value="dpl.example.com"/></td> <td><input type="text" value="1344"/></td> <td><input type="text" value="3"/></td> <td></td> </tr> <tr> <td colspan="4">Service URL</td> </tr> <tr> <td colspan="4"><input type="text" value="icap://dpl.example.com"/></td> </tr> <tr> <td colspan="4" style="font-size: small;">An ICAP URL must begin with icap:// and may not contain any whitespace. Consult your DLP appliance vendor documentation for correct service URL for your system.</td> </tr> <tr> <td colspan="4" style="text-align: center;"><input type="button" value="Start Test"/></td> </tr> </table> </div>	Server Address	Port	Reconnection Attempts		<input type="text" value="dpl.example.com"/>	<input type="text" value="1344"/>	<input type="text" value="3"/>		Service URL				<input type="text" value="icap://dpl.example.com"/>				An ICAP URL must begin with icap:// and may not contain any whitespace. Consult your DLP appliance vendor documentation for correct service URL for your system.				<input type="button" value="Start Test"/>			
Server Address	Port	Reconnection Attempts																							
<input type="text" value="dpl.example.com"/>	<input type="text" value="1344"/>	<input type="text" value="3"/>																							
Service URL																									
<input type="text" value="icap://dpl.example.com"/>																									
An ICAP URL must begin with icap:// and may not contain any whitespace. Consult your DLP appliance vendor documentation for correct service URL for your system.																									
<input type="button" value="Start Test"/>																									
Load Balancing:	Fewest Connections ▾																								
Service Request Timeout:	60 seconds																								
Maximum Simultaneous Connections:	25																								
Failure Handling:	<input checked="" type="radio"/> Permit all data transfers to proceed without scanning <input type="radio"/> Block data transfer for transactions where scanning was requested																								

3. Enter the information in Table 12-2.

Table 12-2 External DLP Server Settings

Setting	Description
External DLP Servers	<p>Enter the following information to access an ICAP compliant DLP system:</p> <ul style="list-style-type: none"> • Server address and port. The host name or IP address and TCP port for accessing the DLP system. • Reconnection attempts. The number of times the Web Proxy tries to connect to the DLP system before failing. • DLP Service URL. The ICAP query URL specific to the particular DLP server. The Web Proxy includes what you enter here in the ICAP request it sends to the external DLP server. The URL must start with the ICAP protocol: icap://
Load Balancing	<p>If multiple DLP servers are defined, select which load balancing technique the Web Proxy uses to distribute upload requests to different DLP servers. You can choose the following load balancing techniques:</p> <ul style="list-style-type: none"> • None (failover). The Web Proxy directs upload requests to one DLP server. It tries to connect to the DLP servers in the order they are listed. If one DLP server cannot be reached, the Web Proxy attempts to connect to the next one in the list. • Fewest connections. The Web Proxy keeps track of how many active requests are with the different DLP servers and it directs the upload request to the DLP server currently servicing the fewest number of connections. • Hash based. The Web Proxy uses a hash function to distribute requests to the DLP servers. The hash function uses the proxy ID and URL as inputs so that requests for the same URL are always directed to the same DLP server. • Round robin. The Web Proxy cycles upload requests equally among all DLP servers in the listed order.
Service Request Timeout	<p>Enter how long the Web Proxy waits for a response from the DLP server. When this time is exceeded, the ICAP request has failed and the upload request is either blocked or allowed, depending on the Failure Handling setting.</p> <p>Default is 60 seconds.</p>
Maximum Simultaneous Connections	<p>Specifies the maximum number of simultaneous ICAP request connections from the Web Security appliance to each configured external DLP server. The Failure Handling setting on this page applies to any request which exceeds this limit.</p> <p>Default is 25.</p>

Table 12-2 External DLP Server Settings (Continued)

Setting	Description
Failure Handling	Choose whether upload requests are blocked or allowed (passed to Access Policies for evaluation) when the DLP server fails to provide a timely response. Default is allow ("Permit all data transfers to proceed without scanning").

4. Optionally, you can add another DLP server by clicking Add Row and entering the DLP Server information in the new fields provided.
5. You can test the connection between the Web Security appliance and the defined external DLP server(s) by clicking **Start Test**.
6. Submit and commit your changes.

CONTROLLING UPLOAD REQUESTS USING EXTERNAL DLP POLICIES

Each upload request is assigned to an External DLP Policy group and inherits the control settings of that policy group. The control settings of the External DLP Policy group determine whether or not to send the upload request to the external DLP system for scanning.

Once the Web Proxy receives the upload request headers, it has all the information necessary to decide if the request should go to the external DLP system for scanning. The DLP system scans the request and returns a verdict to the Web Proxy, either block or monitor (evaluate the request against the Access Policies). The block page provided by the DLP system is shown to the end user, if applicable.

Note — If any Data Security Policy group applies to the upload request, the Web Proxy evaluates the policy group’s control settings against the upload request at the same time the external DLP system scans the request. If a Data Security Policy setting blocks the request before the DLP system is done scanning, the Web Proxy blocks the request and terminates the ICAP session with the DLP system.

Configure control settings for External DLP Policy groups on the Web Security Manager > External DLP Policies page.

Figure 12-7 shows where you can configure control settings for the External DLP Policy groups.

Figure 12-7 Creating External DLP Policies

External DLP Policies

Order	External DLP Policy	Destinations	Delete
1	exampleExternalDLP Policy Identity: TestLab	(global policy)	
	Global Policy Identity: All	Scan: None	

Authentication: ● Enabled ● Disabled Policy Disabled

To configure control settings for an External DLP Policy group:

1. Navigate to the Web Security Manager > External DLP Policies page.
2. Click the link under the Destinations column for the policy group you want to configure.
3. Under the Edit Destination Settings section, choose “Define Destinations Scanning Custom Settings” from the drop down menu if it is not selected already.

Figure 12-8 Scanning Destinations Settings for External DLP Policies

External DLP Policies: Destinations: exampleExternalDLPPolicy

The screenshot shows the 'Edit Destination Settings' window. At the top, there is a dropdown menu labeled 'Define Destinations scanning Custom Settings'. Below this is a section titled 'Scanning Destinations'. Under the heading 'Destinations to Scan:', there are three radio button options: 'Do not scan any uploads' (which is selected), 'Scan all uploads', and 'Scan uploads to specified custom URL categories only'. Below these options is a text box containing the message 'No custom URL categories have been selected' and a link 'Edit custom categories list...'.

4. In the Destination to scan section, choose one of the following options:
 - **Do not scan any uploads.** No upload requests are sent to the configured DLP system(s) for scanning. All upload requests are evaluated against the Access Policies.
 - **Scan all uploads.** All upload requests are sent to the configured DLP system(s) for scanning. The upload request is blocked or evaluated against the Access Policies depending on the DLP system scanning verdict.
 - **Scan uploads to specified custom URL categories only.** Upload requests that fall in specific custom URL categories are sent to the configured DLP system for scanning. The upload request is blocked or evaluated against the Access Policies depending on the DLP system scanning verdict. Click **Edit custom categories list** to select the URL categories to scan.
5. Submit and commit your changes.

LOGGING

The access logs indicate whether or not an upload request was scanned by either the IronPort Data Security Filters or an external DLP server. The access log entries include a field for the IronPort Data Security scan verdict and another field for the External DLP scan verdict based. For more information, see “Understanding Web Reputation and Anti-Malware Information” on page 462.

In addition to the access logs, the Web Security appliance provides the following log file types to troubleshoot IronPort Data Security and External DLP Policies:

- **Data Security Logs.** Records client history for upload requests that are evaluated by the IronPort Data Security Filters.
- **Data Security Module Logs.** Records messages related to the IronPort Data Security Filters.
- **Default Proxy Logs.** In addition recording errors related to the Web Proxy, the default proxy logs include messages related to connecting to external DLP servers. This allows you to troubleshoot connectivity or integration problems with external DLP servers.

The following text illustrates a sample Data Security Log entry:

```
Mon Mar 30 03:02:13 2009 Info: 0 10.1.1.1 - - <<bar,text/
plain,5120><foo,text/plain,5120>> DEFAULT_CASE-allowall-DefaultGroup-
DefaultGroup-NONE-DefaultRouting ns server10.qa nc
```

Table 12-3 describes the Data Security Log fields.

Table 12-3 Data Security Log Fields

Field Value	Description
Wed Feb 11 23:09:18 2009 Info:	Timestamp and trace level
303	Transaction ID
10.1.1.1	Source IP address
-	User name
-	Authorized group names

Table 12-3 Data Security Log Fields (Continued)

Field Value	Description
<<bar, text/plain, 5120>><foo, text/plain, 5120>>	File name, file type, file size for each file uploaded at once Note: This field does not include text/plain files that are less than the configured minimum request body size, the default of which is 4096 bytes. For more information on configuring the minimum request body size, see “Bypassing Upload Requests Below a Minimum Size” on page 234.
MONITOR_AMW_REQ-allowall-DefaultGroup-DefaultGroup-NONE-DefaultRouting	IronPort Data Security Policy and action
ns	WBRS score
server.com	Outgoing URL
nc	URL category

Notifying End Users

This chapter contains the following information:

- “Notifying End Users of Organization Policies” on page 258
- “Configuring General Settings for Notification Pages” on page 260
- “Working With IronPort End-User Notification Pages” on page 262
- “Working with User Defined End-User Notification Pages” on page 269
- “End-User Acknowledgement Page” on page 272
- “Configuring the End-User URL Category Warning Page” on page 276
- “Working with IronPort FTP Notification Messages” on page 277
- “Custom Text in Notification Pages” on page 278
- “Notification Page Types” on page 280

NOTIFYING END USERS OF ORGANIZATION POLICIES

The Web Security appliance helps your organization implement and enforce policies for accessing the web. When a policy blocks a user from a website, you can configure the appliance to notify the user why it blocked the URL request. Web users see a webpage that explains that they were blocked from accessing a website and why they were blocked. These pages are called end-user notification pages. The Web Proxy can display different end-user notification pages depending on the reason it blocked the URL request. You can use the provided end-user notification pages or define your own.

Configure end-user notification pages on the Security Services > End-User Notification page. Figure 13-1 shows where you configure end-user notification settings.

Figure 13-1 Security Services > End-User Notification Page

End-User Notification

End-User Notification	
HTTP General Settings	
Language:	English
Logo Image:	No Image
HTTP End-User Acknowledgement Page	
End-User Acknowledgement:	Disabled
Custom Message:	Undefined
HTTP End-User Notification Pages	
Notification Type:	Use IronPort Notification Pages
Custom Message:	Undefined
Contact Information:	your corporate network administrator
End-User Misclassification Reporting:	Disabled
End User URL Category Warning Page	
Time Between Warning:	1h
Custom Message:	Undefined
Native FTP End-User Notification Pages	
Language:	
Custom Message:	Undefined
Edit Settings...	

You can configure the following types of notification pages and settings:

- **IronPort notification pages.** The Web Proxy displays different, predefined notification pages depending on the reason for blocking the URL request. You can customize these pages. For example, you can use your own logo or add custom text. For more information about IronPort notification pages, see “Working With IronPort End-User Notification Pages” on page 262.
- **User defined notification pages.** You can configure the Web Proxy to redirect all HTTP end-user notification pages to a specific URL. The Web Proxy includes parameters in the redirected URL that explain the reasons for the block so the server in the redirected URL can customize the page it displays. For more information about user defined notification pages, see “Working with User Defined End-User Notification Pages” on page 269.
- **End-user acknowledgement page.** You can configure the Web Proxy to inform users that it is filtering and monitoring their web activity. The Web Proxy does this by displaying an

end-user acknowledgement page when a user first accesses a browser after a certain period of time. When the end-user acknowledgement page appears, users must click a link to access the original site requested or any other website. Language and logo settings apply to the end-user acknowledgement page as well as the notification pages. For more information about configuring the end-user acknowledgement page, see “End-User Acknowledgement Page” on page 272.

- **End-user URL category warning page.** You can configure the Web Proxy to warn users that a site does not meet the organization’s acceptable use policies and allow them to continue if they choose. The Web Proxy does this by displaying an end-user URL category warning page when a user first accesses a website in a particular URL category after a certain period of time. When the end-user URL category warning page appears, users can click a link to access the original site requested. Language and logo settings apply to the end-user URL category warning page as well as the notification pages. For more information about configuring the end-user URL category warning page, see “Warning Users and Allowing Them to Continue” on page 306.
- **FTP notification messages.** The FTP Proxy displays a different, predefined notification messages depending on the reason for blocking a native FTP transaction. You can customize these pages with a custom message. For more information, see “Working with IronPort FTP Notification Messages” on page 277.
- **General notification settings.** You can configure the language used in IronPort notification pages for both HTTP and FTP. You can also configure a logo to use for IronPort notification pages for HTTP requests. For more information, see “Configuring General Settings for Notification Pages” on page 260.

CONFIGURING GENERAL SETTINGS FOR NOTIFICATION PAGES

You can configure the following general settings:

- **Language.** You can configure a different language for HTTP and FTP end-user notification pages. The HTTP language setting applies to all HTTP notification pages (acknowledgement, IronPort end-user, end-user URL category warning, and user defined end-user), and the FTP language applies to all FTP end-user notification messages.
- **Logo.** You can configure a logo for HTTP end-user notification pages only. The logo setting applies to all HTTP notification pages.

To configure the general settings for HTTP notification pages and FTP notification messages:

1. Navigate to the Security Services > End-User Notification page.
2. Click **Edit Settings**.

Edit End-User Notification

HTTP/HTTPS	
General Settings	
Language:	English
Logo Image:	Optionally, an image can be displayed by the web browser as part of every notification and acknowledgement page. <input checked="" type="radio"/> No Image <input type="radio"/> Use IronPort Logo <input type="radio"/> Use Custom Logo: <input type="text"/> (example: http://www.example.com/image.gif)

3. In the General Settings section under the HTTP/HTTPS section, select the language the Web Proxy should use when displaying HTTP notification pages. You can choose any of the following languages:
 - English
 - French
 - German
 - Italian
 - Spanish
 - Japanese
 - Korean
 - Portuguese
 - Russian
 - Thai
 - Traditional Chinese
 - Simplified Chinese

4. Choose whether or not to use a logo on each notification page. You can specify the IronPort logo or any graphic file referenced at the URL you enter in the Use Custom Logo field.

Note — See “Custom Text and Logos: Authentication, and End-User Acknowledgement Pages” on page 278 for more information about working with custom logos.

5. Submit and commit your changes.

WORKING WITH IRONPORT END-USER NOTIFICATION PAGES

When you choose end-user notification pages defined by IronPort, the Web Proxy displays a different page depending on the reason why it blocked the original page. However, you can still customize each page to make them specific to your organization.

You can customize the following features:

- Custom message
- Contact information
- Allow end-users to report misclassified pages to IronPort

You can also edit the IronPort notification pages stored on the Web Security appliance. For more information about how to do this, see “Editing IronPort Notification Pages” on page 264.

Configuring IronPort Notification Pages

To configure IronPort notification pages:

1. Navigate to the Security Services > End-User Notification page, and click **Edit Settings**.

The Edit End-User Notification page appears.

End-User Notification Pages	
Notification Type:	Use IronPort Notification Pages
Custom Message:	<p>Specify additional text to be displayed on every notification page, such as a link to your company policies:</p> <div style="border: 1px solid #ccc; height: 40px;"></div> <p><small>Simple HTML text formatting (such as bold or italics) and links (anchor tags) are supported.</small></p>
Contact Information:	<p>Contact: <input type="text" value="your corporate network administrator"/></p> <p>Email address (optional): <input type="text"/></p> <p><small>The entered contact information will appear in a sentence such as: "If you have questions, or feel this is an error, please contact (email.address@example.com)."</small></p>
End-User Misclassification Reporting: ?	<input type="checkbox"/> Allow end-user to report misclassified pages to IronPort
Preview Notification Page Customization	

2. From the Notification Type field, choose Use IronPort Notification Pages.
3. Configure the IronPort notification page settings.

Table 13-1 describes the settings you can configure for IronPort notification pages.

Table 13-1 IronPort Notification Page Settings

Setting	Description
Custom Message	<p>Choose whether or not to include additional text you specify on each notification page.</p> <p>When you enter a custom message, AsyncOS places the message before the last sentence on the notification page which includes the contact information.</p> <p>You can include some HTML tags in lower case to format the text. For a list of supported HTML tags, see “Supported HTML Tags in Notification Pages” on page 278.</p> <p>See “Custom Text and Logos: Authentication, and End-User Acknowledgement Pages” on page 278 for more information about working with custom messages.</p>
Contact Information	<p>Choose whether or not to customize the contact information listed on each notification page.</p> <p>AsyncOS displays the contact information sentence as the last sentence on a page, before providing notification codes that users can provide to the network administrator.</p>
End-User Misclassification Reporting	<p>Choose whether or not users can report misclassified URLs to IronPort Systems.</p> <p>When you enable this option, an additional button appears on the IronPort notification pages for sites blocked due to suspected malware or URL filters. This button allows the user to report when they believe the page has been misclassified. It does not appear for pages blocked due to other policy settings.</p> <p>When a user presses this button, data about the blocked request gets sent to the Web Security appliance. AsyncOS logs the information in the Feedback Log, summarizes the data, and forwards it to IronPort.</p> <p>This feature helps improve efficiency for administrators, and the IronPort Customer Support process. Additionally, misclassification reports improve the efficacy of URL filtering.</p>

4. Click the “Preview Notification Page Customization” link to view the current end-user notification page in a separate browser window.
5. Submit and commit your changes.

Editing IronPort Notification Pages

Each IronPort Notification page is stored on the Web Security appliance as an HTML file. You can edit the content of these HTML pages to include additional text or to edit the overall look and feel of each page.

You can use variables in the HTML files to display specific information to the user. You can also turn each variable into a conditional variable to create if-then statements. For more information, see “Using Variables in Customized IronPort Notification Pages” on page 267.

Table 13-2 describes the variables you can include in customized end-user notification pages.

Table 13-2 Variables for Customized End-User Notification Pages

Variable	Description	Always Evaluates to TRUE if Used as Conditional Variable
%a	Authentication realm for FTP	No
%A	ARP address	Yes
%b	User-agent name	No
%B	Blocking reason, such as BLOCK-SRC or BLOCK-TYPE	No
%c	Error page contact person	Yes
%C	Entire Set-Cookie: header line, or empty string	No
%d	Client IP address	Yes
%D	User name	No
%e	Error page email address	Yes
%E	The error page logo URL	No
%f	User feedback section	No
%F	The URL for user feedback	No
%g	The web category name, if available	Yes
%G	Maximum file size allowed in MB	No
%h	The host name of the proxy	Yes
%H	The server name of the URL	Yes
%i	Transaction ID as a hexadecimal number	Yes
%l	Management IP Address	Yes

Table 13-2 Variables for Customized End-User Notification Pages (Continued)

Variable	Description	Always Evaluates to TRUE if Used as Conditional Variable
%j	URL category warning page custom text	No
%k	Redirection link for the end-user acknowledgement page and end-user URL category warning page	No
%K	Response file type	No
%l	WWW-Authenticate: header line	No
%L	Proxy-Authenticate: header line	No
%M	The Method of the request, such as "GET" or "POST"	Yes
%n	Malware category name, if available	No
%N	Malware threat name, if available	No
%p	Proxy connection string	Yes
%P	Protocol	Yes
%r	Redirect URL	No
%R	Re-authentication is offered. This variable outputs an empty string when false and a space when true, so it is not useful to use it alone. Instead, use it as condition variable. For more information, see "Using Variables in Customized IronPort Notification Pages" on page 267. For more information on re-authentication, see "Allowing Users to Re-Authenticate" on page 386.	No
%S	The signature of the proxy	No, always evaluates to FALSE
%t	Timestamp in Unix seconds plus milliseconds	Yes
%T	The date	Yes
%u	The URI part of the URL (the URL excluding the server name)	Yes
%U	The full URL of the request	Yes
%v	HTTP protocol version	Yes
%W	Management WebUI port	Yes

Table 13-2 Variables for Customized End-User Notification Pages (Continued)

Variable	Description	Always Evaluates to TRUE if Used as Conditional Variable
%X	Extended blocking code. This is a 16-byte base64 value that encodes the most of the web reputation and anti-malware information logged in the access log, such as the ACL decision tag and WBRs score.	Yes
%Y	Admin custom text string, if set, else empty	No
%y	End-user acknowledgement page custom text	Yes
%z	Web reputation score	Yes
%Z	DLP metadata	Yes
%%	Prints the percent symbol (%) in the notification page	N/A

To edit the IronPort Notification pages:

1. Use an FTP client to connect to the Web Security appliance.
2. Navigate to the `configuration\eun` directory.
In this directory are subdirectories for each supported language for end-user notification pages.
3. Download the language directory files for the IronPort notification pages you want to edit.
4. On your local machine, use a text or HTML editor to edit each HTML file for the IronPort notification pages.

For a list of rules and guidelines, see “Rules and Guidelines for Editing IronPort Notification Pages” on page 267.

5. Use the FTP client to upload the customized HTML files to the same directory from which you downloaded them in step 3.
6. Open an SSH client and connect to the Web Security appliance.
7. Run the `advancedproxyconfig > miscellaneous` CLI command.
8. Hit Enter until you are prompted with the following question:
`Enable custom EUN pages?`
9. If the custom end-user notification pages option is currently disabled, type `1` to enable it.

Note — If the custom end-user notification pages option is currently enabled when you update the HTML files, you must first disable it, commit your changes, and then enable it. If you do not do this, the new files do not take effect until the Web Proxy restarts.

10. Commit your change, and close the SSH client.

Rules and Guidelines for Editing IronPort Notification Pages

Use the following rules and guidelines when editing IronPort notification pages:

- Each customized IronPort notification page file must be a valid HTML file. For a list of HTML tags you can include, see “Supported HTML Tags in Notification Pages” on page 278.
- The customized IronPort notification page file names must exactly match the file names shipped with the Web Security appliance.
- Do not include any links to URLs in the HTML files. Any link included in the notification pages are subject to the access control rules defined in the Access Policies and users might end up in a recursive loop.
- If the configuration `\eun` directory does not contain a particular file with the required name, then the appliance displays the standard IronPort notification page.
- For new IronPort notification pages to go into effect, you must first upload the customized files to the appliance and then enable the customized files using the `advancedproxyconfig > miscellaneous` CLI command.

Using Variables in Customized IronPort Notification Pages

When editing IronPort notification pages, you can include conditional variables to create if-then statements to take different actions depending on the current state. For example, you can create an IronPort notification page that includes a redirect URL (%r) if re-authentication is offered (%R). In this example, you would create a conditional variable out of %R.

Table 13-3 describes the different conditional variable formats.

Table 13-3 Creating Conditional Variables in IronPort Notification Pages

Conditional Variable Format	Description
<code>;%?V</code>	This conditional variable evaluates to TRUE if the output of variable %V is not empty.
<code>;%!V</code>	Represents the following condition: <code>else</code> Use this with the %?V conditional variable.
<code>;%#V</code>	Represents the following condition: <code>endif</code> Use this with the %?V conditional variable.

For example, the following text is some HTML code that uses %R as a conditional variable to check if re-authentication is offered, and uses %r as a regular variable to provide the re-authentication URL.

```
%?R
<div align="left">
  <form name="ReauthInput" action="%r" method="GET">
    <input name="Reauth" type="button"
    OnClick="document.location='%r'"
    id="Reauth" value="Login as different user...">
  </form>
</div>
%#R
```

Any variable included in Table 13-2, “Variables for Customized End-User Notification Pages,” on page 264 can be used as a conditional variable. However, the best variables to use in conditional statements are the ones that relate to the *client request* instead of the server response, and the variables that may or may not evaluate to TRUE instead of the variables that always evaluate to TRUE. For example, the %t variable (timestamp in Unix seconds plus milliseconds) always evaluates to TRUE, so there is little value in making an if-then statement based on it.

WORKING WITH USER DEFINED END-USER NOTIFICATION PAGES

When you choose end-user notification pages defined by someone in your organization, by default, AsyncOS redirects all blocked websites to the URL regardless of the reason why it blocked the original page. However, AsyncOS also passes parameters as a query string appended to the redirect URL so you can ensure that the user sees a unique page explaining the reason for the block.

AsyncOS passes the parameters to the web server as standard URL Parameters in the HTTP GET request. It uses the following format:

```
<notification_page_url>?param1=value1&param2=value2
```

Table 13-4 describes the parameters AsyncOS includes in the query string.

Table 13-4 End-User Notification Parameters for Redirected URLs

Parameter Name	Description
Time	Date and time of the transaction.
ID	Transaction ID.
Client_IP	IP address of the client.
User	Username of the client making the request, if available.
Site	Host name of the destination in the HTTP request.
URI	URL path specified in the HTTP request.
Status_Code	HTTP status code for the request.
Decision_Tag	ACL decision tag as defined in the Access Log entry that indicates how the DVS engine handled the transaction. For more information about ACL decision tags, see "ACL Decision Tags" on page 459.
URL_Cat	URL category that the URL filtering engine assigned to the transaction request. For a list of the different URL categories, see "URL Category Descriptions" on page 313. Note: AsyncOS for Web sends the entire URL category name for both predefined and user defined URL categories. It performs URL encoding on the category name, so spaces are written as "%20".
WBRS	WBRS score that the Web Reputation Filters assigned to the URL in the request.

Table 13-4 End-User Notification Parameters for Redirected URLs (Continued)

Parameter Name	Description
DVS_Verdict	Malware category that the DVS engine assigns to the transaction. For more information about malware categories, “Malware Scanning Verdict Values” on page 480.
DVS_ThreatName	The name of the malware found by the DVS engine.
Reauth_URL	A URL that users can click to authenticate again if the user is blocked from a website due to a restrictive URL filtering policy. Use this parameter when the “Enable Re-Authentication Prompt If End User Blocked by URL Category” global authentication setting is enabled and the user is blocked from a website due to a blocked URL category. To use this parameter, make sure the CGI script performs the following steps: <ol style="list-style-type: none"> 1. Get the value of <code>Reauth_Url</code> parameter. 2. URL-decode the value. 3. Base64 decode the value and get the actual re-authentication URL. 4. Include the decoded URL on the end-user notification page in some way, either as a link or button, along with instructions for users informing them they can click the link and enter new authentication credentials that allow greater access. For more information, see “Allowing Users to Re-Authenticate” on page 386.

Note — AsyncOS always includes all parameters in each redirected URL. If no value exists for a particular parameter, AsyncOS passes a hyphen (-).

When you want the user to view a different page for each reason for a blocked website, construct a CGI script on the web server that can parse the query string in the redirect URL. Then the server can perform a second redirect to an appropriate page.

Consider the following rules and guidelines when entering the custom URL:

- You can use any HTTP or HTTPS URL.
- The URL may specify a specific port number.
- The URL may not have any arguments after the question mark.
- The URL must contain a well-formed host name.

For example, if you have the following URL entered in the Redirect to Custom URL field:

```
http://www.example.com/eun.policy.html
```

And you have the following access log entry:

```
1182468145.492 1 172.17.0.8 TCP_DENIED/403 3146 GET http://
www.espn.com/index.html HTTP/1.1 - NONE/- - BLOCK_WEBCAT-DefaultGroup-
DefaultGroup-NONE-NONE-DefaultRouting <IW_sprt,-,-,-,-,-,-,-,-,-,-
,-,-,-,IW_sprt,-> -
```

Then AsyncOS creates the following redirected URL:

```
http://www.example.com/eun.policy.html?Time=21/Jun/
2007:23:22:25%20%2B0000&ID=0000000004&Client_IP=172.17.0.8&User=-
&Site=www.espn.com&URI=index.html&Status_Code=403&Decision_Tag=
BLOCK_WEBCAT-DefaultGroup-DefaultGroup-NONE-NONE-DefaultRouting
&URL_Cat=Sports%20and%20Recreation&WBRs=-&DVS_Verdict=-&
DVS_ThreatName=-&Reauth_URL=-
```

Configuring User Defined End-User Notification Pages

To configure user defined end-user notification pages:

1. Navigate to the Security Services > End-User Notification page, and click **Edit Settings**.
The Edit End-User Notification page appears.
2. From the Notification Type field, choose Redirect to Custom URL.
3. In the Notification Page URL field, enter the URL to which you want to redirect blocked websites.
Note — You can choose whether or not to preview the URL you enter by clicking the Preview Custom URL link.
4. Submit and commit your changes.

END-USER ACKNOWLEDGEMENT PAGE

You can configure the Web Security appliance to inform users that it is filtering and monitoring their web activity. The appliance does this by displaying an end-user acknowledgement page when a user first accesses a browser after a certain period of time. When the end-user acknowledgement page appears, users must click a link to access the original site requested or any other website.

You might want to use an end-user acknowledgement page to force users to explicitly agree to the terms and conditions for browsing the World Wide Web from the organization's network. This might be useful when the Web Proxy is in transparent mode because web users will not otherwise know that their web transactions are being filtered and monitored for security purposes.

When you configure the appliance to display an end-user acknowledgement page, it does so for every user accessing the web using HTTP or HTTPS. It displays the end-user acknowledgement page when a user tries to access a website for the first time, or after a configured time interval.

Note — Native FTP transactions are exempt from the end-user acknowledgement page.

Users are tracked by username if authentication has made a username available, and tracked by IP address if no username is available.

When you enable the end-user acknowledgement page, you can configure the following settings:

- **Time Between Acknowledgements.** The Time Between Acknowledgements determines how often the Web Proxy displays the end-user acknowledgement page for each user. Once a user clicks the link on the end-user acknowledgement page, the Web Proxy considers that user to have acknowledged the proxy for the time you enter for the Time Between Acknowledgements. This setting applies to users tracked by username and users tracked by IP address. You can specify any value from 30 to 2678400 seconds (one month). Default is 1 day (86400 seconds).
- **Inactivity Timeout.** The Inactivity Timeout determines how long a user tracked and acknowledged by IP address (unauthenticated users only) can be idle before the user is no longer considered acknowledged. You can specify any value from 30 to 2678400 seconds (one month). Default is four hours (14400 seconds).
- **Custom message.** The custom message is text you enter that appears on every end-user acknowledgement page. You can include some simple HTML tags to format the text. For example, you can change the color and size of the text, or make it italicized. See “Custom Text in Notification Pages” on page 278 for more information.

Note — You can only include a custom message when you configure the end-user acknowledgement page in the web interface, versus the CLI.

Consider the following rules and guidelines when enabling the end-user acknowledgement page:

- When a user is tracked by IP address, the appliance uses the shortest value for maximum time interval and maximum IP address idle timeout to determine when to display the end-user acknowledgement page again.
- The first transaction from a user must be an HTTP request, and the user must agree to the terms for all transactions to succeed. If users try to send an HTTPS or native FTP request before an HTTP request, the HTTPS or native FTP request fails.
- When the Web Proxy restarts, the Web Proxy considers all users to have timed out, and it displays the end-user acknowledgement page again. The Web Proxy may restart based on different events, such as when the Default Proxy Log subscription changes or when changes are made to the global authentication settings or FTP Proxy settings.
- When the appliance is deployed in explicit forward mode and a user goes to an HTTPS site, the end-user acknowledgement page includes only the domain name in the link that redirects the user to the originally requested URL. If the originally requested URL contains text after the domain name, that text is truncated.

Configuring the End-User Acknowledgement Page

You can enable and configure the end-user acknowledgement page in the web interface or the command line interface. However, when you configure the end-user acknowledgement page in the web interface, you can include a custom message that appears on each page. You can include some simple HTML tags in the custom message, such as font color and size.

In the CLI, use `advancedproxyconfig > authentication`.

To configure the end-user acknowledgement page in the web interface:

1. Navigate to the Security Services > End-User Notification page.
2. Click **Edit Settings**.

Figure 13-2 Editing End-User Acknowledgment Page Settings

Edit End-User Notification

General Settings	
Language:	English
Logo Image:	<p>Optionally, an image can be displayed by the web browser as part of every notification page.</p> <p><input checked="" type="radio"/> No Image</p> <p><input type="radio"/> Use IronPort Logo</p> <p><input type="radio"/> Use Custom Logo:</p> <p><input type="text" value="http://"/> <small>(example: http://www.example.com/image.gif)</small></p>
End-User Acknowledgement Page	
End-User Acknowledgement:	<p><input type="checkbox"/> Require end-user to click through acknowledgement page</p> <p>Time Between Acknowledgements: <input type="text" value="1d"/></p> <p>Inactivity Timeout: (?) <input type="text" value="4h"/> <small>30 to 2678400 seconds, or use trailing s for seconds, m for minutes, h for hours (examples: 120s, 5m 30s, 4h)</small></p>
Custom Message:	<p>Specify additional text to be displayed on every notification page, such as a link to your company policies:</p> <div style="border: 1px solid gray; height: 100px; width: 100%;"></div> <p><small>Simple HTML text formatting (such as bold or italics) and links (anchor tags) are supported.</small></p>
Preview Acknowledgment Page Customization	

- In the End-User Acknowledgement Page section, enable the “Require end-user to click through acknowledgement page” field. See “Custom Text and Logos: Authentication, and End-User Acknowledgement Pages” on page 278 for information about how this feature works with custom messages.
- In the Time Between Acknowledgements field, enter the time interval the appliance uses between displaying the end-user acknowledgement page.

You can specify any value from 30 to 2678400 seconds (one month). Default is 1 day (86400 seconds). You can enter the value in seconds, minutes, or days. Use ‘s’ for seconds, ‘m’ for minutes, and ‘d’ for days.
- In the Inactivity Timeout field, enter the maximum IP address idle timeout.

You can specify any value from 30 to 2678400 seconds (one month). Default is four hours (14400 seconds). You can enter the value in seconds, minutes, or days. Use ‘s’ for seconds, ‘m’ for minutes, and ‘d’ for days.
- In the Custom Message field, enter any text you want to appear on every end-user acknowledgement page.

You can include some HTML tags in lower case to format the text. For a list of supported HTML tags, see “Supported HTML Tags in Notification Pages” on page 278.

For example:

Please acknowledge the following statements *<i>before</i>* accessing the Internet.

7. Click the “Preview Acknowledgment Page Customization” link to view the current end-user acknowledgement page in a separate browser window.
8. Submit and commit your changes.

CONFIGURING THE END-USER URL CATEGORY WARNING PAGE

You can configure the end-user acknowledgement page on the Security Services > End-User Notification page. You can include some simple HTML tags in the custom message, such as font color and size.

To configure the end-user acknowledgement page:

1. Navigate to the Security Services > End-User Notification page, and click **Edit Settings**.
2. Scroll down to the End-User URL Category Warning Page section.

Figure 13-3 Editing End-User URL Category Warning Page Settings

3. In the Time Between Warning field, enter the time interval the Web Proxy uses between displaying the end-user URL category warning page for each URL category per user.

Once a user clicks the continue link on the end-user URL category warning page, the Web Proxy considers that user to have acknowledged the warning for the time you enter here. This setting applies to users tracked by username and users tracked by IP address.

Default is 1 hour (3600 seconds). You can enter the value in seconds, minutes, or days. Use 's' for seconds, 'm' for minutes, and 'd' for days.

4. In the Custom Message field, enter any text you want to appear on every end-user URL category warning page.

You might want to include text for the organization's acceptable use policies, or include a link to a page that details the acceptable use policies.

You can include some HTML tags in lower case to format the text. For a list of supported HTML tags, see "Supported HTML Tags in Notification Pages" on page 278.

For example:

```
Please acknowledge the following statements <i>before</i> accessing the Internet.
```

5. Click the "Preview URL Category Warning Page Customization" link to view the current end-user URL category warning page in a separate browser window.
6. Submit and commit your changes.

WORKING WITH IRONPORT FTP NOTIFICATION MESSAGES

The FTP Proxy displays a predefined notification message to native FTP clients when there is an error with FTP Proxy authentication. You can customize this FTP notification with a custom message.

To configure IronPort FTP notification messages:

1. Navigate to the Security Services > End-User Notification page, and click **Edit Settings**.
2. Scroll down to the Native FTP section.
3. In the Language field, select the language to use when displaying native FTP notification messages.
4. In the Custom Message field, enter the text you want to display in every native FTP notification message.
5. Submit and commit your changes.

CUSTOM TEXT IN NOTIFICATION PAGES

The following sections apply to custom text entered for IronPort notification and end-user acknowledgement pages.

Supported HTML Tags in Notification Pages

You can format the text in IronPort notification and end-user acknowledgement pages using some HTML tags. Tags must be in lower case and follow standard HTML syntax (closing tags, etc.).

You can use the following HTML tags.

- `<a>`
- ``
- ``
- `<big></big>`
- `
`
- `<code></code>`
- ``
- `<i></i>`
- `<small></small>`
- ``

For example, you can make some text italic:

Please acknowledge the following statements *before* accessing the Internet.

With the `` tag, you can use any CSS style to format text. For example, you can make some text red:

`Warning:` You must acknowledge the following statements *before* accessing the Internet.

Custom Text and Logos: Authentication, and End-User Acknowledgement Pages

All combinations of URL paths and domain names in embedded links within custom text and the custom logo in IronPort notification, end-user acknowledgement, and end-user URL category warning pages are exempted from the following:

- User authentication
- End-user acknowledgment
- All scanning, such as malware scanning and web reputation scoring

For example, if the following URLs are embedded in custom text:

`http://www.example.com/index.html`

`http://www.mycompany.com/logo.jpg`

Then all of the following URLs will also be treated as exempt from all scanning:

`http://www.example.com/index.html`

`http://www.mycompany.com/logo.jpg`

`http://www.example.com/logo.jpg`

`http://www.mycompany.com/index.html`

Also, where an embedded URL is of the form: `<protocol>://<domain-name>/<directory path>/` then all sub-files and sub-directories under that directory path on the host will also be exempted from all scanning.

For example, if the following URL is embedded: `http://www.example.com/gallery2/` URLs such as `http://www.example.com/gallery2/main.php` will also be treated as exempt.

This allows administrators to create a more sophisticated page with embedded content so long as the embedded content is relative to the initial URL. However, you administrators should also take care when deciding which paths to include as links and custom logos.

NOTIFICATION PAGE TYPES

Users accessing the Internet sometimes cannot access the server they want. By default, the Web Proxy displays a notification page informing users they were blocked and the reason for the block. This section lists and describes all possible notification pages a user might see while accessing the Internet.

Possible reasons that cause notification pages to appear include the following:

- IronPort notification pages are enabled and the user accessed the Internet in a way that violated an Access Policy.
- IronPort notification pages are configured to allow end-users to report misclassified pages to IronPort and the user reported a misclassified page.
- The end-user acknowledgement page is enabled and the user accessed the Internet for the first time since the timeout period expired.
- The HTTPS Proxy is enabled and the appliance is configured to drop HTTPS requests to servers with invalid certificates.
- The Web Security appliance could not access the server requested due to an external error, such as DNS failure or an unavailable server.

Most notification pages display a different set of codes that may help administrators or IronPort Customer Support troubleshoot any potential problem. Some codes are for IronPort internal use only.

Table 13-5 describes the different possible codes used in each notification page.

Table 13-5 Codes Used in Notification Pages

Notification Code	Code Description
<version>	The version of the notification message. For IronPort internal use only.
<ACL>	The ACL decision tag that indicates how the DVS engine handled the transaction. For a list of ACL decision tags, see “ACL Decision Tags” on page 459.
<malware_value>	Malware scanning verdict value. For a list of malware scanning verdict values, see “Malware Scanning Verdict Values” on page 480.
<ID>	Transaction ID. For IronPort internal use only.
<time>	The time the error occurred.
<blocking>	Blocking code. For IronPort internal use only.
<HTTP_error>	HTTP error text returned by the web server.

Table 13-5 Codes Used in Notification Pages (Continued)

Notification Code	Code Description
<IP>	Client IP address.
<file_type>	File type of the file the client attempted to download.
<protocol>	The protocol the client requested to use.
<redirected_URL>	The URL to which the client is redirected.
<host_name>	Host name of the web server.

Table 13-6 describes the different notification pages users might encounter.

Table 13-6 Notification Page Types

Notification Title	Notification Text	Notification Codes
Feedback Accepted, Thank You	The misclassification report has been sent. Thank you for your feedback.	N/A
Access Forbidden	Based on your corporate Access Policies, this web site <URL> has been blocked because it has been determined to be a security threat to your computer or the corporate network. Access could also be blocked because this request came from an unrecognized or unauthorized machine.	(<version>, ACCESS_FORBIDDEN, <ACL>, <malware_value>, <ID>, <time>, <blocking>, <HTTP_error>)
Policy: Authentication	Based on your corporate Access Policies, Internet access has been blocked because the login provided belongs to a user or group that is not allowed Internet access.	(<version>, AUTH, <ACL>)
Bad Request	The system cannot process this request. A non-standard browser may have generated an invalid HTTP request. If you are using a standard browser, please retry the request.	(<version>, BAD_REQUEST)
Policy: Destination	Based on your corporate Access Policies, access to this web site <URL> has been blocked.	(<version>, BLOCK_DEST, <ACL>, <HTTP_error>)
Policy: Source	Based on your corporate Access Policies, access to this web site <URL> has been blocked because this request came from an unauthorized computer.	(<version>, BLOCK_SRC, <ACL>, <IP>, <HTTP_error>)

Table 13-6 Notification Page Types (Continued)

Notification Title	Notification Text	Notification Codes
Security: Browser	<p>Based on your corporate Access Policies, requests from your computer have been blocked because it has been determined to be a security threat to the corporate network. Your browser may have been compromised by a malware/spyware agent identified as "<i><malware name></i>".</p> <p>Please contact <i><contact name></i> <i><email address></i> and provide the codes shown below.</p> <p>If you are using a non-standard browser and believe it has been misclassified, use the button below to report this misclassification.</p>	<p>(<i><version></i>, BROWSER, <i><ACL></i>, <i><browser_type></i>, <i><ID></i>, <i><time></i>, <i><blocking></i>, <i><HTTP_error></i>)</p>
Policy: Browser	<p>Based on your corporate Access Policies, requests from your browser have been blocked. This browser "<i><browser type></i>" is not permitted due to potential security risks.</p>	<p>(<i><version></i>, BROWSER_CUSTOM, <i><ACL></i>, <i><browser_type></i>, <i><ID></i>, <i><time></i>, <i><HTTP_error></i>)</p>
Invalid Certificate	<p>A secure session cannot be established because the site <i><host name></i> provided an invalid certificate.</p>	<p>(<i><version></i>, INVALID_CERT, <i><ACL></i>, <i><ID></i>, <i><time></i>, <i><blocking></i>, <i><HTTP_error></i>)</p>
DNS Failure	<p>The host name resolution (DNS lookup) for this host name <i><host name></i> has failed. The Internet address may be misspelled or obsolete, the host <i><host name></i> may be temporarily unavailable, or the DNS server may be unresponsive.</p> <p>Please check the spelling of the Internet address entered. If it is correct, try this request later.</p>	<p>(<i><version></i>, DNS_FAIL, <i><host_name></i>)</p>
Expectation Failed	<p>The system cannot process the request for this site <i><URL></i>. A non-standard browser may have generated an invalid HTTP request.</p> <p>If using a standard browser, please retry the request.</p>	<p>(<i><version></i>, EXPECTATION_FAILED, <i><HTTP_error></i>)</p>
Policy: File Size	<p>Based on your corporate Access Policies, access to this web site or download <i><URL></i> has been blocked because the download size exceeds the allowed limit.</p>	<p>(<i><version></i>, FILE_SIZE, <i><ACL></i>, <i><HTTP_error></i>)</p>
Policy: File Type	<p>Based on your corporate Access Policies, access to this web site or download <i><URL></i> has been blocked because the file type "<i><file type></i>" is not allowed.</p>	<p>(<i><version></i>, FILE_TYPE, <i><ACL></i>, <i><file_type></i>, <i><HTTP_error></i>)</p>

Table 13-6 Notification Page Types (Continued)

Notification Title	Notification Text	Notification Codes
Filter Failure	The request for page <URL> has been denied because an internal server is currently unreachable or overloaded. Please retry the request later.	(<version>, FILTER_FAILURE, <HTTP_error>)
Found	The page <URL> is being redirected to <redirected URL>.	(<version>, FOUND, <redirected_URL>, <HTTP_error>)
FTP Aborted	The request for the file <URL> did not succeed. The FTP server <host name> unexpectedly terminated the connection. Please retry the request later.	(<version>, FTP_ABORTED, <HTTP_error>)
FTP Authorization Required	Authentication is required by the FTP server <host name>. A valid user ID and password must be entered when prompted. In some cases, the FTP server may limit the number of anonymous connections. If you usually connect to this server as an anonymous user, please try again later.	(<version>, FTP_AUTH_REQUIRED, <host_name>)
FTP Connection Failed	The system cannot communicate with the FTP server <host name>. The FTP server may be temporarily or permanently down, or may be unreachable because of network problems. Please check the spelling of the address entered. If it is correct, try this request later.	(<version>, FTP_CONNECTION_FAILED, <host_name>)
FTP Forbidden	Access was denied by the FTP server <host name>. Your user ID does not have permission to access this document.	(<version>, FTP_FORBIDDEN, <host_name>)
FTP Not Found	The file <URL> could not be found. The address is either incorrect or obsolete.	(<version>, FTP_NOT_FOUND, <HTTP_error>)
FTP Server Error	The system cannot communicate with the FTP server <host name>. The FTP server may be temporarily or permanently down, or may not provide this service. Please confirm that this is a valid address. If it is correct, try this request later.	(<version>, FTP_SERVER_ERR, <host_name>)

Table 13-6 Notification Page Types (Continued)

Notification Title	Notification Text	Notification Codes
FTP Service Unavailable	The system cannot communicate with the FTP server <i><host name></i> . The FTP server may be busy, may be permanently down, or may not provide this service. Please confirm that this is a valid address. If it is correct, try this request later.	(<i><version></i> , FTP_SERVICE_UNAVAIL, <i><host_name></i>)
Gateway Timeout	The system cannot communicate with the external server <i><host name></i> . The Internet server may be busy, may be permanently down, or may be unreachable because of network problems. Please check the spelling of the Internet address entered. If it is correct, try this request later.	(<i><version></i> , GATEWAY_TIMEOUT, <i><host_name></i>)
Internal Error	Internal system error when processing the request for the page <i><URL></i> . Please retry this request. If this condition persists, please contact <i><contact name></i> <i><email address></i> and provide the code shown below.	(<i><version></i> , INTERNAL_ERROR, <i><HTTP_error></i>)
Security: Malware Risk	Based on your corporate Access Policies, this web site <i><URL></i> has been blocked because it has been determined to be a security threat to your computer or the corporate network. This web site has been associated with malware/spyware.	(<i><version></i> , MALWARE_GENERAL, <i><ACL></i> , <i><malware_value></i> , <i><ID></i> , <i><time></i> , <i><blocking></i> , <i><HTTP_error></i>)
Security: Malware Detected	Based on your corporate Access Policies, this web site <i><URL></i> has been blocked because it has been determined to be a security threat to your computer or the corporate network. <i>Malware <malware name></i> in the category <i><malware category></i> has been found on this site.	(<i><version></i> , MALWARE_SPECIFIC, <i><ACL></i> , <i><malware_value></i> , <i><ID></i> , <i><time></i> , <i><blocking></i> , <i><HTTP_error></i>)
Miss Access Forbidden	This web site <i><URL></i> has been blocked because it has been determined to be a security threat, based on your corporate Access Policies.	(<i><version></i> , MISS_ACCESS_FORBIDDEN, <i><HTTP_error></i>)
No More Forwards	The request for the page <i><URL></i> failed. The server address <i><host name></i> may be invalid, or you may need to specify a port number to access this server.	(<i><version></i> , NO_MORE_FORWARDS, <i><HTTP_error></i>)

Table 13-6 Notification Page Types (Continued)

Notification Title	Notification Text	Notification Codes
Only if Cached But Not in Cache	The page <URL> has been blocked based on your corporate policies.	(<version>, ONLY_IF_CACHED_NOT_IN_CACHE, <HTTP_error>)
Policy: General	Based on your corporate Access Policies, access to this web site <URL> has been blocked.	(<version>, POLICY, <ACL>, <ID>, <time>, <blocking>, <HTTP_error>)
Policy: Protocol	Based on your corporate Access Policies, this request has been blocked because the data transfer protocol " <i><protocol type></i> " is not allowed.	(<version>, PROTOCOL, <ACL>, <protocol>, <ID>, <time>, <HTTP_error>)
Proxy Authorization Required	Authentication is required to access the Internet using this system. A valid user ID and password must be entered when prompted.	(<version>, PROXY_AUTH_REQUIRED)
Redirect	This request is being redirected. If this page does not automatically redirect, click here to proceed.	N/A
Policy Acknowledgement, Internet Access Policy Acknowledgement	<p>Please acknowledge the following statements before accessing the Internet.</p> <p>Your web transactions will be automatically monitored and processed to detect dangerous content and to enforce corporate policies. By clicking the link below, you acknowledge this monitoring and accept that data about the sites you visit may be recorded. You will be periodically asked to acknowledge the presence of the monitoring system. You are responsible for following corporate policies on Internet access.</p> <p>Click here to accept this statement and access the Internet.</p>	N/A
Proxy Not Licensed	<p>Internet access is not available without proper licensing of the security device.</p> <p>Please contact <contact name> <email address> and provide the code shown below.</p> <p>Note: To access the management interface of the security device, enter the configured IP address with port.</p>	(<version>, PROXY_UNLICENSED)

Table 13-6 Notification Page Types (Continued)

Notification Title	Notification Text	Notification Codes
Range Not Satisfiable	The system cannot process this request. A non-standard browser may have generated an invalid HTTP request. If you are using a standard browser, please retry the request.	(<version>, RANGE_NOT_SATISFIABLE)
Redirect Permanent	The page <URL> is being redirected to <redirected URL>.	(<version>, REDIRECT_PERMANENT, <redirected_URL>, <HTTP_error>)
Redirect, Repeat Request	Please repeat your request.	(<version>, REDIRECT_REPEAT_REQUEST)
Server Name Expansion	The server name <host name> appears to be an abbreviation, and is being redirected to <redirected URL>.	(<version>, SERVER_NAME_EXPANSION, <redirected_URL>, <host_name>)
SOCKS Failure	The server name <host name> could not be processed while retrieving the page <URL>. This could be due to a problem communicating with the external server.	(<version>, SOCKS_FAIL <HTTP_error>)
URI Too Long	The requested URL was too long and could not be processed. This may represent an attack on your network. Please contact <contact name> <email address> and provide the code shown below.	(<version>, URI_TOO_LONG)
Policy: URL Filtering	Based on your corporate Access Policies, access to this web site <URL> has been blocked because the web category "<category type>" is not allowed.	(<version>, WEBCAT, <ACL>, <ID>, <time>, <blocking>, <HTTP_error>)
WWW Authorization Required	Authentication is required to access the requested web site <host name>. A valid user ID and password must be entered when prompted.	(<version>, WWW_AUTH_REQUIRED, <host_name>)

URL Filters

This chapter contains the following information:

- “URL Filters Overview” on page 288
- “Configuring the URL Filtering Engine” on page 291
- “Filtering Transactions Using URL Categories” on page 292
- “Custom URL Categories” on page 301
- “Redirecting Traffic” on page 304
- “Warning Users and Allowing Them to Continue” on page 306
- “Creating Time Based URL Filters” on page 308
- “Viewing URL Filtering Activity” on page 309
- “Regular Expressions” on page 310
- “URL Category Descriptions” on page 313

URL FILTERS OVERVIEW

AsyncOS for Web allows administrators to control user access based on the web server category of a particular HTTP or HTTPS request. For example, you can block all HTTP requests for gambling web sites, or you can decrypt all HTTPS requests for web-based email websites.

Using policy groups, you can create secure policies that control access to web sites containing objectionable or questionable content. The sites that are actually blocked, dropped, allowed, or decrypted depend on the categories you select when setting up category blocking for each policy group.

To control user access based on a URL category, you must enable one of the following URL filtering engines:

- **Cisco IronPort Web Usage Controls.** This is a multi-layered URL filtering engine that uses domain prefixes and keyword analysis to categorize URLs, and real-time response content analysis using the Dynamic Content Analysis engine if no category is determined by prefixes and keywords. It includes over 65 predefined URL categories. This engine also allows end users and administrators to report to IronPort any miscategorized URLs as well as uncategorized URLs for future inclusion in the categorization database.

For more information, see “Dynamic Content Analysis Engine” on page 288.

- **IronPort URL Filters.** This URL filtering engine categorizes URLs in the client request using domains stored in a database. It includes more than 50 predefined URL categories, and allows end users and administrators to report to IronPort any uncategorized URLs.

You can use URL categories when performing the following tasks:

- **Define policy group membership.** You can define policy group membership by the URL category of the request URL.
- **Control access to HTTP, HTTPS, and FTP requests.** You can choose to allow or block HTTP and FTP requests by URL category using Access Policies, and you can choose to pass through, drop, or decrypt HTTPS requests by URL category using Decryption Policies. You can also choose whether or not to block upload requests by URL category using IronPort Data Security Policies. For more information, see “Filtering Transactions Using URL Categories” on page 292.

In addition to the predefined URL categories included with the URL filtering engine, you can create user defined custom URL categories that specify specific host names and IP addresses. For more information, see “Custom URL Categories” on page 301.

Dynamic Content Analysis Engine

The Dynamic Content Analysis engine is a scanning engine called at response time to categorize a transaction that failed categorization using only the URL in the client request. You might want to enable Dynamic Content Analysis when your organization’s traffic visits more of the newer, and therefore not yet categorized, sites on the Internet.

Enable the Dynamic Content Analysis engine when you enable Cisco IronPort Web Usage Controls on the Security Services > Acceptable Use Controls page.

After the Dynamic Content Analysis engine categorizes a URL, it stores the category verdict and URL in a temporary cache. This allows future transactions to benefit from the earlier response scan and be categorized at request time instead of at response time, and it improves overall performance.

The Dynamic Content Analysis engine categorizes URLs when controlling access to websites in Access Policies only. It does not categorize URLs when determining policy group membership or when controlling access to websites using Decryption or IronPort Data Security Policies. This is because the engine works by analyzing the response content from the destination server, so it cannot be used on decisions that must be made at request time before any response is downloaded from the server.

Enabling the Dynamic Content Analysis engine can impact transaction performance. However, most transactions are categorized using the Cisco IronPort Web Usage Controls URL categories database, so the Dynamic Content Analysis engine is usually only called for a small percentage of transactions.

Note — It is possible for an Access Policy, or an Identity used in an Access Policy, to define policy membership by a predefined URL category and for the Access Policy to perform an action on the same URL category. In this case, it is also possible for the URL in the request to be uncategorized when determining Identity and Access Policy group membership, but to be categorized by the Dynamic Content Analysis engine after receiving the server response. In this scenario, Cisco IronPort Web Usage Controls ignores the category verdict from the Dynamic Content Analysis engine and the URL retains the “uncategorized” verdict for the remainder of the transaction. However, future transactions still benefit from the new category verdict.

Uncategorized URLs

An uncategorized URL is a URL that does not match any pre-defined URL category or *included* custom URL category.

Note — When determining policy group membership, a custom URL category is considered included only when it is selected for policy group membership.

All transactions resulting in unmatched categories are reported on the Monitor > URL Categories page as “Uncategorized URLs.” A large number of uncategorized URLs are generated from requests to web sites within the internal network. Because this type of internal transaction can falsely inflate reporting data and misrepresent the efficacy of the URL filtering engine, IronPort recommends using custom URL categories to group internal URLs and allow all requests to internal web sites. This decreases the number of web transactions reported as “Uncategorized URLs” and instead reports internal transactions as part of “URL Filtering Bypassed” statistics.

For more information, see “Understanding Unfiltered and Uncategorized Data” on page 309.

For more information about creating custom URL categories, see “Custom URL Categories” on page 301.

Matching URLs to URL Categories

When the URL filtering engine matches a URL category to the URL in a client request, it first evaluates the URL against the custom URL categories *included* in the policy group. If the URL in the request does not match an included custom category, the URL filtering engine compares it to the predefined URL categories. If the URL does not match any included custom or predefined URL categories, the request is uncategorized.

Note — When determining policy group membership, a custom URL category is considered included only when it is selected for policy group membership.

For more information about uncategorized URLs, see “Uncategorized URLs” on page 289.

The URL Categories Database

The Web Security appliance collects information and maintains its own filtering categories database. The different URL filtering engines maintain separate databases. The filtering categories databases periodically receive updates from the IronPort update server (<https://update-manifests.ironport.com>). Server updates are automated, and the update interval is set by the server as opposed to the appliance. Updates to the database occur with a regular degree of frequency, and require no administrator intervention.

Cisco IronPort Web Usage Controls shares some database components with the Web Reputation Filters (WBRS) database. Because of this shared information, IronPort recommends fully participating in the SenderBase Network because it allows Cisco IronPort Web Usage Controls to validate and categorize all URLs dynamically classified by the Dynamic Content Analysis engine, including all URLs that could not otherwise be classified, improving overall efficacy.

For information about update intervals and the IronPort update server, see “Manually Updating Security Service Components” on page 545.

CONFIGURING THE URL FILTERING ENGINE

To apply predefined category settings to policy groups and configure custom settings to manage web transactions, you must first enable and choose a URL filtering engine, either the Cisco IronPort Web Usage Controls URL filtering engine or the IronPort URL Filters. By default, the Cisco IronPort Web Usage Controls URL filtering engine is enabled in the System Setup Wizard.

When you enable URL filtering, you can choose the default action the Web Proxy should use when the URL filtering engine is unavailable, either monitor or block.

To configure the URL filtering engine:

1. Navigate to the Security Services > Acceptable Use Controls page.
2. Click **Edit Global Settings**.

The Edit Acceptable Use Controls Settings page appears.

Edit Acceptable Use Controls Settings

Acceptable Use Controls Settings	
<i>When Acceptable Use Controls service is enabled, a user could configure acceptable use policies based on URL filtering and more.</i>	
<input checked="" type="checkbox"/> Enable Acceptable Use Controls	
Acceptable Use Controls Service:	<input type="radio"/> IronPort URL Filters <input checked="" type="radio"/> Cisco IronPort Web Usage Controls <input checked="" type="checkbox"/> Enable Dynamic Content Analysis Engine
Default Action for Unreachable Service:	<input checked="" type="radio"/> Monitor <input type="radio"/> Block

3. Verify the Enable Acceptable Use Controls property is enabled.
4. In the Acceptable Use Controls Service area, choose which URL filtering engine to enable, either IronPort URL Filters or Cisco IronPort Web Usage Controls.
5. If you enable Cisco IronPort Web Usage Controls, choose whether or not to enable the Dynamic Content Analysis Engine.

For more information on the Dynamic Content Analysis Engine, see “Dynamic Content Analysis Engine” on page 288.

6. Choose the default action the Web Proxy should use when the URL filtering engine is unavailable, either Monitor or Block. Default is Monitor.
7. Submit and commit your changes.

FILTERING TRANSACTIONS USING URL CATEGORIES

The URL filtering engine configured allows you to filter transactions in Access, Decryption, and Data Security Policies. To configure URL filtering in a policy group, click the link in the policies table under the URL Categories column for the policy group you want to edit. For more information about the policies table, see “Using the Policies Tables” on page 130.

When you configure URL categories for policy groups, you can configure actions for custom URL categories, if any are defined, and predefined URL categories. For more information about custom URL categories, see “Custom URL Categories” on page 301.

The URL filtering actions you can configure depends on the type of policy group.

- **Access Policies.** See “Configuring URL Filters for Access Policy Groups” on page 292.
- **Decryption Policies.** See “Configuring URL Filters for Decryption Policy Groups” on page 295.
- **IronPort Data Security Policies.** See “Configuring URL Filters for Data Security Policy Groups” on page 297.

Configuring URL Filters for Access Policy Groups

You can configure URL filtering for user defined Access Policy groups and the Global Policy Group.

To configure URL filtering in an Access Policy group:

1. Navigate to the Web Security Manager > Access Policies page.
2. Click the link in the policies table under the URL Categories column for the policy group you want to edit.

The Access Policies: URL Categories: *polycyname* page appears.

Figure 14-1 Configuring Access Policy URL Categories

Access Policies: URL Categories: ExampleAccessPolicy

Custom URL Category Filtering							
<i>These URL Categories are defined as group membership criteria. All other categories are not applicable for this policy.</i>							
View: Included Categories Only All Categories	Use Global Settings	Override Global Settings					Time-Based
		Redirect	Allow ?	Monitor	Warn ?	Block	
	Select all	Select all	Select all	Select all	Select all	Select all	
intranet [Exclude]	—						
TrustedPartnerSites [Include]	—						

Cancel

Submit

Predefined URL Category Filtering					
<i>These URL Categories are defined as group membership criteria. All other categories are not applicable for this policy.</i>					
Category	Use Global Settings	Override Global Settings			Time-Based
		Monitor	Warn ?	Block	
	Select all	Select all	Select all	Select all	
Adult					
Advertisements					
Alcohol and Tobacco					
Arts and Entertainment					
Automatic Updating					

- In the Custom URL Category Filtering section, choose an action for each custom URL category. Table 14-1 describes each action.

Table 14-1 URL Category Filtering for Access Policies

Action	Description
<p>Include (Exclude)</p>	<p>Choose whether or not the URL filtering engine should compare the client request against the custom URL category. The URL filtering engine compares client requests against included custom URL categories, and ignores excluded custom URL categories.</p> <p>The URL filtering engine compares the URL in a client request to <i>included</i> custom URL categories before predefined URL categories. However, by default, custom URL categories are excluded from evaluation. You can override this behavior by clicking the Include link for a custom URL category.</p> <p>Once you click the Include link, it changes to an Exclude link to allow you to exclude the category in the policy again.</p> <p>When a custom URL category is excluded in the global Access Policy, then the default action for included custom URL categories in user defined Access Policies is Monitor instead of Use Global Settings. You cannot choose Use Global Settings when a custom URL category is excluded in the global Access Policy.</p> <p>Note: You must include a custom URL category before you can choose an action, such as block, to assign to it.</p>
<p>Use Global Setting</p>	<p>Uses the action for this category in the Global Policy Group. This is the default action for user defined policy groups.</p> <p>Applies to user defined policy groups only.</p>
<p>Redirect</p>	<p>Redirects traffic originally destined for a URL in this category to a location you specify. When you choose this action, the Redirect To field appears. Enter a URL to which to redirect all traffic.</p> <p>For more information about redirecting traffic, see “Redirecting Traffic” on page 304.</p>
<p>Allow</p>	<p>Always allows client requests for web sites in this category.</p> <p>Allowed requests bypass all further filtering and malware scanning.</p> <p>Only use this setting for trusted web sites. You might want to use this setting for internal sites.</p>
<p>Monitor</p>	<p>The Web Proxy neither allows nor blocks the request. Instead, it continues to evaluate the client request against other policy group control settings, such as web reputation filtering.</p>

Table 14-1 URL Category Filtering for Access Policies (Continued)

Action	Description
Warn	The Web Proxy initially blocks the request and displays a warning page, but allows the user to continue by clicking a hypertext link in the warning page. For more information, see “Warning Users and Allowing Them to Continue” on page 306.
Block	The Web Proxy denies transactions that match this setting.
Time-Based	The Web Proxy blocks or monitors the request during the time ranges you specify. For more information about creating time based URL filtering actions, see “Creating Time Based URL Filters” on page 308.

4. In the Predefined URL Category Filtering section, choose one of the following actions for each category:
 - Use Global Settings
 - Monitor
 - Warn
 - Block
 - Time-Based

See Table 14-1 for details on these actions.
5. In the Uncategorized URLs section, choose the action to take for client requests to web sites that do not fall into a predefined or custom URL category.
6. Submit and commit your changes.

Configuring URL Filters for Decryption Policy Groups

You can configure URL filtering for user defined Decryption Policy groups and the global Decryption Policy group.

To configure URL filtering in a Decryption Policy group:

1. Navigate to the Web Security Manager > Decryption Policies page.
2. Click the link in the policies table under the URL Categories column for the policy group you want to edit.

The Decryption Policies: URL Categories: *policyname* page appears.

Figure 14-2 Configuring Decryption Policy URL Categories

Decryption Policies: URL Categories: ExampleDecryptionPolicy

Custom URL Category Filtering

These URL Categories are defined as group membership criteria. All other categories are not applicable for this policy.

	Use Global Settings	Override Global Settings					Time-Based
		Pass Through	Monitor	Decrypt	Drop	Drop	
View: Included Categories Only All Categories	Select all	Select all	Select all	Select all	Select all	Select all	
intranet [Exclude]	–		✓				
TrustedPartnerSites [Include]	–						

Predefined URL Category Filtering

These URL Categories are defined as group membership criteria. All other categories are not applicable for this policy.

Category	Use Global Settings	Override Global Settings					Time-Based
		Pass Through	Monitor	Decrypt	Drop	Drop	
Select all	Select all	Select all	Select all	Select all	Select all	Select all	
Adult	✓						
Advertisements	✓						
Alcohol and Tobacco	✓						
Arts and Entertainment	✓						
Automatic Updating	✓						

3. Choose an action for each custom and predefined URL category. Table 14-2 describes each action.

Table 14-2 URL Category Filtering for Decryption Policies

Action	Description
Include (Exclude)	<p>Choose whether or not the URL filtering engine should compare the client request against the custom URL category. The URL filtering engine compares client requests against included custom URL categories, and ignores excluded custom URL categories.</p> <p>The URL filtering engine compares the URL in a client request to <i>included</i> custom URL categories before predefined URL categories. However, by default, custom URL categories are excluded from evaluation. You can override this behavior by clicking the Include link for a custom URL category.</p> <p>Once you click the Include link, it changes to an Exclude link to allow you to exclude the category in the policy again.</p> <p>When a custom URL category is excluded in the global Decryption Policy, then the default action for included custom URL categories in user defined Decryption Policies is Monitor instead of Use Global Settings. You cannot choose Use Global Settings when a custom URL category is excluded in the global Decryption Policy.</p> <p>Note: You must include a custom URL category before you can choose an action, such as block, to assign to it.</p>

Table 14-2 URL Category Filtering for Decryption Policies (Continued)

Action	Description
Use Global Setting	Uses the action for this category in the global Decryption Policy group. This is the default action for user defined policy groups. Applies to user defined policy groups only.
Pass Through	Passes through the connection between the client and the server without inspecting the traffic content. You might want to pass through connections to trusted secure sites, such as well known banking and financial institutions.
Monitor	The Web Proxy neither allows nor blocks the request. Instead, it continues to evaluate the client request against other policy group control settings, such as web reputation filtering.
Decrypt	Allows the connection, but inspects the traffic content. The appliance decrypts the traffic and applies Access Policies to the decrypted traffic as if it were a plaintext HTTP connection. By decrypting the connection and applying Access Policies, you can scan the traffic for malware. You might want to decrypt connections to third party email providers, such as gmail or hotmail. For more information about how the appliance decrypts HTTPS traffic, see “Decrypting HTTPS Traffic” on page 211.
Drop	Drops the connection and does not pass the connection request to the server. The appliance does not notify the user that it dropped the connection. You might want to drop connections to third party proxies that allow users on the network bypass the organization’s acceptable use policies.

Note — If you want to *block* a particular URL category for HTTPS requests, choose to decrypt that URL category in the Decryption Policy group and then choose to block the same URL category in the Access Policy group.

4. In the Uncategorized URLs section, choose the action to take for client requests to web sites that do not fall into a predefined or custom URL category. You can choose any action listed in Table 14-2.
5. Submit and commit your changes.

Configuring URL Filters for Data Security Policy Groups

You can configure URL filtering for user defined Data Security Policy groups and the Global Policy Group.

To configure URL filtering in a Data Security Policy group:

1. Navigate to the Web Security Manager > IronPort Data Security Policies page.

- Click the link in the policies table under the URL Categories column for the policy group you want to edit.

The IronPort Data Security Policies: URL Categories: *policyname* page appears.

Figure 14-3 Configuring Data Security Policy URL Categories

IronPort Data Security Policies: URL Categories: ExampleIDSPolicy

Custom URL Category Filtering

These URL Categories are defined as group membership criteria. All other categories are not applicable for this policy.

	Use Global Settings	Override Global Settings		
		Allow ?	Monitor ⚠	Block ⛔
View: Included Categories Only All Categories				
+ intranet [Exclude]	-	Select all	Select all	Select all
TrustedPartnerSites [Include]	-		✓	

Cancel
Submit

Predefined URL Category Filtering

These URL Categories are defined as group membership criteria. All other categories are not applicable for this policy.

	Use Global Settings	Override Global Settings	
		Monitor ⚠	Block ⛔
Category	Select all	Select all	Select all
+ Adult	✓		
+ Advertisements	✓		
+ Alcohol and Tobacco	✓		
+ Arts and Entertainment	✓		
+ Automatic Updating	✓		

3. In the Custom URL Category Filtering section, choose an action for each custom URL category. Table 14-3 describes each action.

Table 14-3 URL Category Filtering for IronPort Data Security Policies

Action	Description
<p>Include (Exclude)</p>	<p>Choose whether or not the URL filtering engine should compare the client request against the custom URL category. The URL filtering engine compares client requests against included custom URL categories, and ignores excluded custom URL categories.</p> <p>The URL filtering engine compares the URL in a client request to <i>included</i> custom URL categories before predefined URL categories. However, by default, custom URL categories are excluded from evaluation. You can override this behavior by clicking the Include link for a custom URL category.</p> <p>Once you click the Include link, it changes to an Exclude link to allow you to exclude the category in the policy again.</p> <p>When a custom URL category is excluded in the global IronPort Data Security Policy, then the default action for included custom URL categories in user defined IronPort Data Security Policies is Monitor instead of Use Global Settings. You cannot choose Use Global Settings when a custom URL category is excluded in the global IronPort Data Security Policy.</p> <p>Note: You must include a custom URL category before you can choose an action, such as block, to assign to it.</p>
<p>Use Global Setting</p>	<p>Uses the action for this category in the Global Policy Group. This is the default action for user defined policy groups.</p> <p>Applies to user defined policy groups only.</p>
<p>Allow</p>	<p>Always allows upload requests for web sites in this category. Applies to custom URL categories only.</p> <p>Allowed requests bypass all further data security scanning and the request is evaluated against Access Policies.</p> <p>Only use this setting for trusted web sites. You might want to use this setting for internal sites.</p>
<p>Monitor</p>	<p>The Web Proxy neither allows nor blocks the request. Instead, it continues to evaluate the upload request against other policy group control settings, such as web reputation filtering.</p>
<p>Block</p>	<p>The Web Proxy denies transactions that match this setting.</p>

4. In the Predefined URL Category Filtering section, choose one of the following actions for each category:
 - Use Global Settings

- Monitor
- Block

See Table 14-3 for details on these actions.

5. In the Uncategorized URLs section, choose the action to take for upload requests to web sites that do not fall into a predefined or custom URL category.
6. Submit and commit your changes.

CUSTOM URL CATEGORIES

The Web Security appliance ships with many predefined URL categories by default, such as Web-based Email and more. However, you can also create user defined custom URL categories that specify specific host names and IP addresses. You might want to create custom URL categories for internal sites or a group of external sites you know you can trust.

Create, edit, and delete custom URL categories on the Web Security Manager > Custom URL Categories page.

Figure 14-4 Custom URL Categories Page

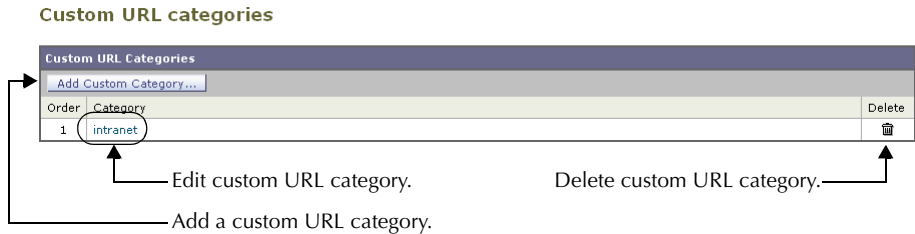

Note — The Web Security appliance uses the first four characters of custom URL category names preceded by "c_" in the access logs. Consider the custom URL category name if you use Sawmill for IronPort to parse the access logs. If the first four characters of the custom URL category include a space, Sawmill for IronPort cannot properly parse the access log entry. Instead, only use supported characters in the first four characters if you will use Sawmill for IronPort to parse the access logs. If you want to include the full name of a custom URL category in the access logs, add the %XF format specifier to the access logs. For more information on how to do this, see "Custom Formatting in Access Logs and W3C Logs" on page 470.

It is possible to create multiple custom URL categories and include the same URL in each category. The order of the custom URL categories matters. Categories listed higher in the list take priority over categories listed lower. When you include these custom URL categories in the same Access, Decryption, or IronPort Data Security Policy group and define different actions to each category, the action of the higher included custom URL category takes effect.

To create or edit a custom URL category:

1. Navigate to the Web Security Manager > Custom URL Categories page.
2. To create a custom URL category, click **Add Custom Category**. To edit an existing custom URL category, click the name of the URL category.

Figure 14-5 Creating a Custom URL Category

Custom URL Categories: Add Category

3. Enter the settings in Table 14-4 for the custom URL category.

Table 14-4 Custom URL Category Settings

Setting	Description
Category Name	Enter a name for the URL category. This name appears when you configure URL filtering for policy groups.
List Order	Choose the order in the list of custom URL categories to place this category. Enter "1" for the topmost URL category. The URL filtering engine evaluates a client request against the custom URL categories in the order specified.
Sites	Enter one or more addresses that belong in the custom category. You can enter multiple addresses separated by line breaks or commas. You can enter addresses using any of the following formats: <ul style="list-style-type: none"> • IP address, such as 10.1.1.0 • CIDR address, such as 10.1.1.0/24 • Domain name, such as example.com • Hostname, such as crm.example.com • Partial hostname, such as .example.com Note: Entering a partial hostname, such as .example.com, also matches www.example.com.

Table 14-4 Custom URL Category Settings (Continued)

Setting	Description
Advanced: Regular Expressions	<p>You can use regular expressions to specify multiple web servers that match the pattern you enter.</p> <p>Note: The URL filtering engine compares URLs with addresses entered in the Sites field first. If the URL of a transaction matches an entry in the Sites field, it is not compared to any expression entered here.</p> <p>For more information about using regular expressions in the Web Security appliance, see “Regular Expressions” on page 310.</p>

4. Optionally, click **Sort URLs** to sort all addresses in the Sites field.
Note — Once you sort the addresses, you cannot retrieve their original order.
5. Submit and commit your changes.

REDIRECTING TRAFFIC

In addition to using the Web Security appliance to monitor and block traffic to certain websites, you can also use it to redirect users to a different website. You can configure the appliance to redirect traffic originally destined for a URL in a custom URL category to a location you specify. This allows you to redirect traffic at the appliance instead of at the destination server.

You might want to redirect traffic at the appliance if your organization published the links to an internal site, but the location of the site changed since publication, or if you do not have control over the web server.

Configure the appliance to redirect custom URL categories to another location when you configure the URL categories for an Access Policy group. You can redirect traffic for a custom Access Policy group or the Global Policy Group.

Note — To redirect traffic, you must define at least one custom URL category. For more information about creating custom URL categories, see “Custom URL Categories” on page 301.

Note — Beware of infinite loops when you configure the appliance to redirect traffic. For example, if you redirect traffic destined for <http://A.example.com> to <http://B.example.com> and you also inadvertently redirect traffic destined for <http://B.example.com> to <http://A.example.com>, then you create an infinite loop. In this case, the appliance redirects the traffic back and forth between the two URLs indefinitely.

To redirect traffic:

1. Navigate to the Web Security Manager > Access Policies page.
2. Click the link under the URL Categories column for an Access Policy group or the Global Policy Group.

The Access Policies: URL Categories: *polycynname* page appears.

3. In the Custom URL Category Filtering section, verify the custom URL category you want to redirect is included. If the Include link displays, click it. If the Exclude link displays, the category is already included.
4. Click the Redirect column for the custom category you want to redirect.
5. Enter the URL to which you want to redirect traffic in the Redirect To field for the custom category.

Custom URL Category Filtering					
<i>These URL Categories are defined as group membership criteria. All other categories are not applicable for this policy.</i>					
	Use Global Settings	Override Global Setting			
		Redirect	Allow	Monitor	Warn
View: Included Categories Only All Categories	Select all	Select all	Select all	Select all	Select all
intranet [Exclude] Redirect to: <input type="text" value="http://intranet.example.com"/>					
trustedPartnerSites [Include]					

- Submit and commit your changes.

WARNING USERS AND ALLOWING THEM TO CONTINUE

In addition to using the Web Security appliance to block traffic to certain websites, you can also use it to warn users that a site does not meet the organization's acceptable use policies and allow them to continue if they choose. You might want to warn users and allow them to continue if your organization wants to discourage its users from accessing certain sites, but does not want to or is not allowed by law to block access to those sites.

To warn users and allow them to continue, configure the URL categories for an Access Policy group.

When users access a URL that is configured to warn and continue, they initially see an IronPort notification page with a warning about accessing sites of this category. The end-user URL category warning page includes the following elements:

- Default warning text provided by IronPort
- Custom text provided by the Web Security appliance administrator (optional)
- Notification code listing the invoked Access Policy and the URL category being warned
- A hypertext link to the originally requested URL

Users are tracked in the access log by user name if authentication has made a user name available, and tracked by IP address if no user name is available.

When you use the warn and continue feature, you can configure the following settings that affect the end-user URL category warning page:

- **Time Between Warning.** The Time Between Warning determines how often the Web Proxy displays the end-user URL category warning page for each URL category per user. Once a user clicks the continue link on the end-user URL category warning page, the Web Proxy considers that user to have acknowledged the warning for the time you enter for the Time Between Warning. This setting applies to users tracked by username and users tracked by IP address. You can specify any value from 30 to 2678400 seconds (one month). Default is 1 hour (3600 seconds).
- **Custom message.** The custom message is text you enter that appears on every end-user URL category warning page. You might want to include text for the organization's acceptable use policies, or include a link to a page that details the acceptable use policies. You can include some simple HTML tags to format the text. For example, you can change the color and size of the text, or make it italicized. See "Custom Text in Notification Pages" on page 278 for more information.

Configure these settings on the Security Services > End-User Notification page. For more information, see "Configuring the End-User URL Category Warning Page" on page 276.

Note — The warn and continue feature only works for HTTP and decrypted HTTPS transactions. It does not work with native FTP transactions.

User Experience When Warning Users

When the URL filtering engine warns users for a particular request, it provides a warning page that the Web Proxy sends to the end user. However, not all websites display the warning page to the end user. For example, some Web 2.0 websites display dynamic content using javascript instead of a static webpage and are not likely to display the warning page from the Web Proxy. When this happens, users are blocked from the URL that is assigned the Warn option without being given the chance to continue accessing the site anyway.

CREATING TIME BASED URL FILTERS

You can configure how the Web Security appliance handles requests for URLs in particular categories differently based on time and day. For example, you can block access to social networking sites, such as blogs and forums, during business hours.

To define URL filtering actions by time you must first define at least one time range. For information about time ranges, see “Working with Time Based Policies” on page 136.

To create time based URL filtering actions for an Access Policy:

1. Navigate to the Web Security Manager > Access Policies page.
2. Click the link in the policies table under the URL Categories column for the policy group you want to edit.

The Access Policies: URL Categories: *policyname* page appears.

3. Select Time-Based for the custom or predefined URL category you want to configure based on time range.

Figure 14-6 Defining Time Based URL Filtering Actions

Predefined URL Category Filtering					
<i>These URL Categories are defined as group membership criteria. All other categories are not applicable for this policy.</i>					
Category	Use Global Settings	Override Global Settings			
	Select all	Monitor	Warn (?)	Block	Time-Based
Adult	<input checked="" type="checkbox"/>				
Advertisements	<input checked="" type="checkbox"/>				
Alcohol and Tobacco	<input checked="" type="checkbox"/>				
Arts and Entertainment In time range: <input type="text" value="BusinessHours"/> Action: <input type="text" value="Block"/> Otherwise: <input type="text" value="Use Global (Monitor)"/>					<input checked="" type="checkbox"/>
Automatic Updating	<input checked="" type="checkbox"/>				

When you select Time-Based for the URL category, additional fields appear under the category name where you can choose the actions.

4. In the In Time Range field, choose the defined time range to use for the URL category. For information about defining time ranges, see “Creating Time Ranges” on page 136.
5. In the Action field, choose the action to enact on transactions in this URL category during the defined time range.
6. In the Otherwise field, choose the action to enact on transactions in this URL category *outside* the defined time range.
7. Submit and commit your changes.

VIEWING URL FILTERING ACTIVITY

The Monitor > URL Categories page provides a collective display of URL statistics that includes information about top URL categories matched and top URL categories blocked. Additionally, this page displays category-specific data for bandwidth savings and web transactions. For detailed information about monitoring and reporting functionality, see “Monitoring” on page 415.

Understanding Unfiltered and Uncategorized Data

When viewing URL statistics on the Monitor > URL Categories page, it is important to understand how to interpret the following data:

- **URL Filtering Bypassed** — This data represents policy, port, and admin user agent blocking that occurs before URL filtering.
- **Uncategorized URL** — This data represents all transactions for which the URL filtering engine is queried, but no category is matched.

Access Log File

The access log file records the URL category for each transaction in the Web Reputation filtering and anti-malware scanning section of each entry. For more information about the access log, see “Access Log File” on page 456. For a list of each URL category, see “URL Category Descriptions” on page 313.

REGULAR EXPRESSIONS

Regular expressions are pattern matching descriptions that contain normal printable characters and special characters that are used to match patterns in text strings. For example, a text string such as “welcome” matches “welcome” or “welcomemyfriend.” When a match occurs, the function returns true. If no match occurs, the function returns false. Actions are executed only when a pattern-matching expression is true.

The Web Security appliance uses POSIX extended regular expression syntax, fully described by IEEE POSIX 1003.2. However, the appliance does not support using a backward slash to escape a forward slash. If you need to use a forward slash in a regular expression, type the forward slash without a backward slash.

Note — Technically, AsyncOS for Web uses the Flex regular expression analyzer. For more detailed information about how it reads regular expressions, see <http://flex.sourceforge.net/manual/Patterns.html>.

You can use regular expressions in the following locations:

- **Custom URL categories for Access Policies.** When you create a custom URL category to use with Access Policy groups, you can use regular expressions to specify multiple web servers that match the pattern you enter. For more information about creating custom URL categories, see “Custom URL Categories” on page 301.
- **Custom user agents to block.** When you edit the applications to block for an Access Policy group, you can use regular expressions to enter specific user agents to block, such as Skype or Microsoft Internet Explorer. For more information about using regular expressions to block user agents, see “Policy: Applications” on page 182.

Note — Regular expressions that perform extensive character matching consume resources and can affect system performance. For this reason, regular expressions should be cautiously applied.

Forming Regular Expressions

Regular expressions are rules that typically use the word “matches” in the expression. They can be applied to match specific URL destinations or web servers. For example, the following regular expression matches any pattern containing blocksite.com:

```
\.blocksite\.com
```

Consider the following regular expression example:

```
server[0-9]\.example\.com
```

In this example, `server[0-9]` matches `server0`, `server1`, `server2`, ..., `server9` in the domain `example.com`.

In the following example, the regular expression matches files ending in `.exe`, `.zip`, and `.bin` in the `downloads` directory.

/downloads/.*\.(exe|zip|bin)

Avoid using regular expressions strings that are redundant because they can cause higher CPU usage on the Web Security appliance. A redundant regular expression is one that starts or ends with “.*”.

Note — You must enclose regular expressions that contain blank spaces or non-alphanumeric characters in ASCII quotation marks.

Regular Expression Character Table

Table 14-5 describes characters that are commonly used to form regular expressions:

Table 14-5 Regular Expression Character Descriptions

Character	Description
.	Matches a single character.
*	Matches zero or more occurrences of the preceding regular expression. For example: [0-9]* matches any number of digits “.*” matches any arbitrary string of characters
^	Matches the beginning of a line as the first character of a regular expression.
\$	Matches the end of a line as the last character of a regular expression.
+	Matches one or more occurrences of the preceding regular expression.
?	Matches zero or one occurrence of the preceding regular expression.
	Matches the preceding regular expression or the following regular expression. For example: x y matches either x or y abc xyz matches either of the strings abc or xyz
[]	Matches the characters or digits that are enclosed within the brackets. For example: [a-z] matches any character between a and z [r-u] matches any of the characters r, s, t, or u [0-3] matches any of the single digits 0, 1, 2, 3
{ }	Specifies the number of times to match the previous pattern. For example: D{1,3} matches one to three occurrences of the letter D

Table 14-5 Regular Expression Character Descriptions (Continued)

Character	Description
()	Group characters in a regular expression. For example: (abc)* matches abc or abcabcabc
"..."	Literally interprets any characters enclosed within the quotation marks.
\	Escape character.

Note — To match the literal version of any of the special characters, the character must be preceded by a backslash “\”. For example, to exactly match a period “.” the regular expression must use “\.” as in “\example\.com”. However, the appliance does not support using a backward slash to escape a forward slash. If you need to use a forward slash in a regular expression, type the forward slash without a backward slash.

URL CATEGORY DESCRIPTIONS

This section lists the URL categories for both URL filtering engines. The tables also include the abbreviated URL category names that may appear in the in the Web Reputation filtering and anti-malware scanning section of an access log file entry.

Note — The URL category abbreviations for Cisco IronPort Web Usage Controls include the prefix “IW_” before each abbreviation so that the “art” category becomes “IW_art.”

Table 14-6 lists and describes the URL categories for the Cisco IronPort Web Usage Controls.

Table 14-6 URL Category Descriptions for Cisco IronPort Web Usage Controls

URL Category	Abbreviation	Code	Description	Example URLs
Adult	adlt	1006	These are sites directed to adults, not necessarily pornographic sites. Adult clubs: strip clubs, swingers clubs, escort services, strippers; general information about sex, non-pornographic in nature; genital piercing; adult products, adult greeting cards; information about sex not in the context of health or disease.	cybereroticnews.com/ dansex.dk/ cqsex.com/ crotchrocket.us/ toperotique.com
Advertisements	adv	1027	Banner and pop-up ads that often accompany a web page; other advertising sites that provide advertisement content.	doubleclick.com banners.yellowpages.co.uk ads.msn.com affiliateclicks.com arc6.msn.com
Alcohol and Tobacco	at	1048	Beer, wine, spirits: beer and wine making, cocktail recipes, liquor sellers, wineries, vineyards, breweries; mixed drinks; tobacco; pipes and smoking products.	smokers.com/ michiganbrewersguild.org/ johnnieWalker.com/ cigaraficionado.com/ lvcwines.com/
Arts and Entertainment	art	1002	Galleries and exhibitions; artists and art; photography; literature and books, publishing; movies; performing arts and theater; music and radio; television; celebrities and fan sites; design; architecture; entertainment news, venues; humor.	kidrock.com guitarist.co.uk entertainment.yahoo.com/ drudgereportarchives.com nycballet.com

Table 14-6 URL Category Descriptions for Cisco IronPort Web Usage Controls (Continued)

URL Category	Abbreviation	Code	Description	Example URLs
Business and Industry	busi	1019	Sites involved in business-to-business transactions of all kinds. Advertising, marketing, commerce, corporations, business practices, workforce, human resources, transportation, payroll, security, venture capital, etc; office supplies; industrial equipment (process equipment), machines and mechanical systems; heating equipment, cooling equipment; materials handling equipment; packaging equipment; manufacturing: solids handling, metal fabrication construction and building; passenger transportation; commerce; industrial design; construction, building materials; industrial design; shipping and freight: freight services, trucking, freight forwarders, truckload carriers, freight/transportation brokers, expedited services, load & freight matching, track & trace, NVOCC, railroad shipping, ocean shipping, road feeder services, moving & storage; online meetings.	smithbearing.com paychex.com newholland.com adsonwheels.com cat.com
Cheating and Plagiarism	plag	1051	Sites promoting cheating and selling written work (e.g., term papers) for plagiarism.	schoolsucks.com/ thesis-statements.com/ academictermpapers.com/ cheathouse.com/ nursingpapers.com/
Child Porn	cprn	1064	Sites that host child pornography and pedophilia.	No examples can be legally/ethically given.
Computer Security	csec	1065	Sites that offer security product and services for corporate and home users.	abuse.net activesecuritymonitor.com iisprotect.com securityfocus.com sectools.org

Table 14-6 URL Category Descriptions for Cisco IronPort Web Usage Controls (Continued)

URL Category	Abbreviation	Code	Description	Example URLs
Computers and Internet	comp	1003	Information about computers and software such as: hardware, software, software support sites; information for software engineers, programming and networking; website design, and the web and Internet in general; computer science; computer graphics and clipart.	wallpapers.com unicode.org redhat.com/ msexchange.org geeksquad.com
Cults	cult	1041	Cults and cult behavior.	churchofsatan.com/ voodoo.de/ hexen.org/ magical-lights.de/ heavensgate.com/
Dating	date	1055	Dating sites, online personals, matrimonial agencies, etc., for adults.	catholicmatch.com/ collegeluv.com/ allpersonals.com eharmony.com farmersonly.com
Dining and Drinking	food	1061	Eating and drinking establishments; restaurants, bars, taverns, brewpubs; restaurant guides and reviews.	southcitygrill.com chilis.com elnuevorodeo.com/ pizzahut.co.uk mcdonalds.com
Education	edu	1001	Education-related sites and web pages such as schools, colleges, universities, teaching materials, teachers resources; technical and vocational training; online training; education issues and policy; financial aid; school funding; standards and testing.	ucla.edu pearsonhighered.com k12.ca.us/ homeworknow.com gedpractice.com
File Transfer Services	fts	1071	Sites with the primary purpose of providing download services and hosted file sharing.	yousendit.com rapidshare.com techsofttools.com sharefile.com/ 2large2email.com

Table 14-6 URL Category Descriptions for Cisco IronPort Web Usage Controls (Continued)

URL Category	Abbreviation	Code	Description	Example URLs
Filter Avoidance	filt	1025	Web pages that promote and aid undetectable and anonymous surfing.	proxyblind.org the-cloak.com proxybuster.net youhide.com zend2.com
Finance	fnc	1015	Sites and information that are primarily financial in nature such as: accounting practices and accountants; taxation; banking; insurance; investing; information relating to the stock market, stocks, bonds, mutual funds, brokers, stock analysis and commentary, stock screens, stock charts, IPOs, stock splits; the national economy; personal finance involving insurance of all types; credit cards; retirement and estate planning; loans; mortgages; taxes.	finance.yahoo.com usbank.com nasdaq.com lendingtree.com shopyourmortgage.ca
Freeware and Shareware	free	1068	Sites that provide downloading of freeware and shareware software.	all-freeware.com download.com freewarefiles.com onlyfreewares.com uberdownloads.com
Gambling	gamb	1049	Casinos and online gambling sites; bookmakers and odds; gambling advice; horse and dog racing in a gambling context; sports book; sports gambling.	eurobet.co.uk/ pokerworld.com onlinepokernews.com bodog.com blindbetspoker.com
Games	game	1007	Various card games, board games, word games, video games; computer games, Internet games (RPGs and D&D); combat games; sports games; downloadable games; game reviews; cheat sheets.	netdevil.com games.com games.yahoo.com/ pogo.com cheatworld.com

Table 14-6 URL Category Descriptions for Cisco IronPort Web Usage Controls (Continued)

URL Category	Abbreviation	Code	Description	Example URLs
Government and Law	gov	1011	Foreign relations; news and information relating to politics and elections such as: politics, political parties, election news and voting; sites and information relating the field of law such as: attorneys, law firms, law publications, legal reference material, courts, dockets, legal associations; legislation and court decisions; civil rights issues; immigration; patents and copyrights; sites and information relating to law enforcement and correctional systems; sites related to crime, crime reporting, law enforcement, crime statistics, etc; sites relating to the military such as: the armed forces, military bases, military organizations, and military equipment; anti-terrorism.	texas.gov legalzoom.com fenwick.com comcast.net/news/politics/ barackobama.com
Hacking	hack	1050	Sites discussing ways to hack into web sites, software, and computers.	crackfind.com/ hackthissite.org/ dirkster.com/ trinsic.org/ sweethacks.com/
Hate Speech	hate	1016	Hate-related sites, involving racism, sexism, racist theology; hate music; Christian identity religions; World Church of the Creator; Neo-Nazi organizations: Aryan Nations, American Nazi parties, Neo-Nazis, Ku Klux Klan, National Alliance, White Aryan Resistance, white supremacists; National Socialist Movement; Holocaust denial.	panzerfaust.com bloodandhonour.com kkk.com nazi.org blacksandjews.com

Table 14-6 URL Category Descriptions for Cisco IronPort Web Usage Controls (Continued)

URL Category	Abbreviation	Code	Description	Example URLs
Health and Nutrition	hlth	1009	Health care; disease and disabilities; medical care; hospitals; doctors; medicinal drugs; mental health; psychiatry; pharmacology; exercise and fitness; physical disabilities; vitamins and supplements; sex in a context of health (disease and health care); tobacco use, alcohol use, drug use, and gambling in a context of health (disease and health care); food in general; food and beverage; cooking and recipes; food and nutrition, health, dieting; cooking, including recipe and culinary sites.	webmd.com health.gov stjohns.com lowcarb.ca fitness.com chefmoz.org cookingmarvel.com
Illegal Activities	crmr	1022	Pages that promote crime such as stealing, fraud, phreaking and cracking; warez and pirated software; computer viruses; terrorism, bombs, and anarchy; sites depicting murder and suicide as well as explaining ways to commit them.	lockpickonline.com grokster.com anarchistcookbook.com directwarez.com ddlshark.com
Illegal Drugs	drug	1047	Information about recreational drugs, drug paraphernalia, marijuana seeds; advice on how to grow marijuana.	marijuana.com sporeworks.com/ cleartest.com/ bcseeds.com/ drugs-plaza.com/
Infrastructure	misc	1018	Content delivery infrastructure and dynamically-generated content - these cannot be more specifically categorized because the pages are secured or otherwise difficult to categorize	example.com/ akamai.net imagenet.co.uk/ edgecastcdn.net/ webstat.net/
Instant Messaging	im	1039	Web-based instant messaging.	messenger.yahoo.com/ meebo.com/ friendvox.com aimonpsp.com buddy4u.com

Table 14-6 URL Category Descriptions for Cisco IronPort Web Usage Controls (Continued)

URL Category	Abbreviation	Code	Description	Example URLs
Internet Telephony	voip	1067	Sites that provide telephonic services using the Internet	aussievoip.com.au downloadsquad.com/ category/voip/ skypepc.com simplecall.net packet8.net
Job Search	job	1004	Career advice; advice on resume writing and interviewing skills; job placement services; job databanks; employment and temp agencies; employer sites.	jobs.com siena.edu/careercenter/ policeemployment.com novastaffinginc.com monster.de
Lingerie and Swimsuits	ling	1031	Intimate apparel, especially when modeled.	victoriasecret.com sportsillustrated.cnn.com/ swimsuit/ henryandjune.com/ lingerieiva.com/ lingerieowl.com/
Lottery and Sweepstakes	lotr	1034	Sweepstakes, contests and lotteries.	calottery.com state.nj.us/lottery/ powerball.com/ hoosierlottery.com/ national-lottery.co.uk/
Mobile Phones	cell	1070	Sites that provide SMS services; ringtones.	shop.orange.co.uk savemysms.fr smartphonemag.com sprint.com jamster.com

Table 14-6 URL Category Descriptions for Cisco IronPort Web Usage Controls (Continued)

URL Category	Abbreviation	Code	Description	Example URLs
Nature	natr	1013	Natural resources; ecology and conservation; forests; wilderness; plants; flowers; forest conservation; forest, wilderness, forestry practices; forest management (re-forestation, forest protection, conservation, harvesting, forest health, thinning, prescribed burning); agricultural practices: agriculture, gardening, horticulture, landscaping, planting, weed control, irrigation, pruning, harvesting; pollution issues: air quality, hazardous waste, pollution prevention, recycling, waste management, water quality, environmental clean-up industry; animals, pets, livestock, zoology; biology; botany.	nature.org/ enature.com/ fs.fed.us/ roselinebunnies.com chicagobotanic.org
News	news	1058	News, headlines; newspapers; TV station websites.	cnn.com/ abcnews.com news9.com/ koreatimes.co.kr/ nytimes.com/
Non-sexual Nudity	nsn	1060	Nudism/nudity; nudist camps; artistic nudes.	simplenudes.com barenakedgallery.com fineartnude.com grex.com erosgallery.net
Online Communities	comm	1024	Personal web pages; affinity groups; special interest groups; professional organizations for social purposes; personal photo collections; web newsgroups; e-cards; message boards.	reptileforums.co.uk photo.net wendyjohnson.net threadoftheday.com startrek.com
Online Storage and Backup	osb	1066	Sites providing offsite, peer to peer, and cloud storage for backup, sharing and hosting.	angelbackup.com ibackup.com myotherdrive.com elephantdrive.com allmydata.com/

Table 14-6 URL Category Descriptions for Cisco IronPort Web Usage Controls (Continued)

URL Category	Abbreviation	Code	Description	Example URLs
Online Trading	trad	1028	Online brokerages, sites which afford the user the ability to trade stocks online.	tdwaterhouse.com tradingdirect.com scottrade.com pricegroup.com orionfutures.com
Paranormal and Occult	nonm	1029	Non-mainstream approaches to life. Occult practices: esoteric magic, voodoo, witchcraft, casting spells; fortune telling practices: I Ching, numerology, psychic advice, Tarot; paranormal: out of body, astral travel, seances; astrology, horoscopes; UFOs and aliens.	witchcraft.com tarot.com spiritualguidance.com horoscopes.aol.com californiapsychics.com
Peer File Transfer	p2p	1056	Peer-to-peer file request sites. This does not track the file transfers themselves.	bittorrent.com/ downloadaccess.net/ filesoup.co.uk/ piratebay.org/ limewire.com
Porn	porn	1054	Sexually explicit text or depictions. Includes the following: nude celebrities; anime and XXX cartoons; general XXX depictions; material of a sexually violent nature (bondage, domination, sadomasochism, torture, rape, spanking, snuff, fantasy death, necrophilia); other fetish material (foot/legs, infantilism, balloon sex, latex gloves, enema, pregnant women, pony-play, BBW, bestiality); XXX chat rooms; sex simulators; sites that offer strip poker; adult movies; lewd art; web-based pornographic e-mail.	playboy.com penthouse.com hustler.com vivid.com xxx.com

Table 14-6 URL Category Descriptions for Cisco IronPort Web Usage Controls (Continued)

URL Category	Abbreviation	Code	Description	Example URLs
Real Estate	rest	1045	Information that would support the search for real estate. This includes: office and commercial space; real estate listings: rentals, apartments, homes; house building; roommates, etc.	realtor.com zillow.com/ remax.com joannekizerrealestate.com/ rockfordhomesinc.com/
Reference	fyi	1017	City and state guides; maps, weather, time; reference sources; dictionaries; libraries; museums; ski conditions; personal information; mass transportation: consumer mass transit information (bus, commuter train, subway, airport), schedules.	weather.com timezoneconverter.com metrocommute.com maps.google.com dictionary.com
Safe for Kids	yc	1057	Sites directed toward and specifically approved for young children.	webkinz.com/ kinderthemes.com/ kids.nationalgeographic.com/ nickjr.com/ pingu.net/
Science and Technology	sci	1012	Sites involving science and technology: aerospace, electronics, engineering, mathematics, etc.; space exploration; meteorology; geography; environment; energy: oil, nuclear, wind, sun; communications: telephones, telecomm.	technologyreview.com space.com awea.org ieee.org carbonpower.com
Search Engines and Portals	srch	1020	Web directories and search engines that often serve as home pages such as Excite, MSN, Alta Vista, and Google.	google.com baidu.com bing.com kablum.com kellysearch.com
Sex Ed and Abortion	sxed	1052	Sexual health; information about, or descriptions of, abortion procedures such as: abortion pills, medical abortions, surgical abortions; abortion clinics and abortion providers.	prochoice.org/ prolife.com/ teensource.org/ mens-sexual-health.org/ dontcrossyourfingers.co.uk/

Table 14-6 URL Category Descriptions for Cisco IronPort Web Usage Controls (Continued)

URL Category	Abbreviation	Code	Description	Example URLs
Shopping	shop	1005	Auctions; bartering; online purchasing; coupons and free offers; yellow pages; classified ads; general office supplies; online catalogs; online malls.	ticketmaster.com radioshack.com pier1.com amazon.com ecco.com
Social Networking	snet	1069	Sites that provide social networking.	myspace.com facebook.com linkedin.com twitter.com badoo.com
Social Science	socs	1014	Sites related to: archaeology; anthropology; cultural studies; economics; history; linguistics; philosophy; political science; psychology; theology; women's studies.	templarhistory.com civilwar.com abrp.org languagelearninglab.com sociologyonline.net
Society and Culture	scty	1010	Family and relationships; religions; ethnicity and race; social organizations; genealogy; seniors; clothing and fashion; spas; hair salons; cosmetics (skin care for diseases or conditions may be categorized as Health and Nutrition); hobbies; do-it-yourself; toys for kids; model and remote controlled cars; toy soldiers; childcare.	christianity.com/ women.com unitedway.org safekids.com hairfinder.com
Software Updates	swup	1053	Sites that host updates for software packages.	windowsupdate.com symantecliveupdate.com updates.ironport.com macupdate.com rhn.redhat.com
Spiritual Healing	heal	1042	Spiritual healing; alternative approaches to health, both physical and mental.	touchingspirit.org/ spiritual-medium.com/ mountainvalleycenter.com/ holisticmed.com/ dancing-bear.com/

Table 14-6 URL Category Descriptions for Cisco IronPort Web Usage Controls (Continued)

URL Category	Abbreviation	Code	Description	Example URLs
Sports and Recreation	sprt	1008	All sports, professional and amateur; recreational activities; hunting; fishing; fantasy sports; gun and hunting clubs; public parks; amusement parks; water parks; theme parks; zoos and aquariums.	espn.go.com sports.yahoo.com nfl.com fantasyfootball.com/ hickoryhawks.org
Streaming Media	mdia	1026	Sites that involve: net radio; net TV; web casts; streaming audio; streaming video.	wired.com/news/radio/ warm1069.com pandora.com blip.tv capitalfm.co.uk
Tasteless or Obscene	obs	1033	Sites that offer tasteless, often gory photographs such as autopsy photos, photos of crime scenes, crime or accident victims; sites displaying excessive obscene material.	torture-museum.com/ scatworld.net theelectricchair.com cadaver.org ehowa.com
Tattoos	tat	1043	Pictures and text relating to body modification; tattoos and piercing venues; articles and information about tattoos and piercing; body painting.	tattoo.com/ tattoosbyhoss.com/ rankmytattoos.com/ coolshop.com/ alohamonkeytattoo.com/
Transportation	trns	1044	Sites about personal transportation; information about cars and motorcycles; shopping for new and used cars and motorcycles; car clubs; boats, airplanes, RVs, etc. (Note: auto and motorcycle racing is categorized as Sports and Recreation).	volkswagen.com/ transwestgmc.com/ mgscustombikes.com/ autobytel.com/ autos.msn.com/
Travel	trvl	1046	Business and personal travel: travel information; travel resources; travel agents; vacation packages; cruises; lodging and accommodations; travel transportation: flight booking, airfares, renting cars; vacation homes.	travelocity.com/ travel.yahoo.com/ yellowstone.net/ russia-travel.com/ hyatt.com/

Table 14-6 URL Category Descriptions for Cisco IronPort Web Usage Controls (Continued)

URL Category	Abbreviation	Code	Description	Example URLs
Violence	viol	1032	Sites related to violence and violent behavior.	realights.com severe-spanking.com justfights.com facesofdeath.com maafa.org/
Weapons	weap	1036	Sites or information relating to the purchase or use of conventional weapons such as: gun sellers; gun auctions; gun classified ads; gun accessories; gun shows; gun training; general information about guns; other weapons (e.g., knives, brass knuckles) may be included.	northcoastknives.com gunsworld.com gunsmagazine.com colt.com army.mod.uk/equipment
Web Hosting	whst	1037	Sites that provide web site hosting services.	rackspace.com/ godaddy.com/ 1and1.com/ startlogic.com/ doteasy.com/
Web Page Translation	tran	1063	Web sites that translate web pages into/from English. Also allow clicking to other pages on given site.	babelfish.yahoo.com google.com/language_tools itools.com/lang/ lingro.com online-translator.com
Web-based Chat	chat	1040	Web-based chat sites.	teenchat.com/ freechatnow.com/ chat.realtruck.com/ chatango.com/ chatzy.com/
Web-based Email	mail	1038	Email portals and email messages ported through the web.	mail2web.com/ mail.google.com/ mail.yahoo.com/ webmail.covad.net/ outlook.monroecollege.edu/ exchange/

Table 14-7 lists the URL categories for IronPort URL Filters.

Table 14-7 URL Categories for IronPort URL Filters

URL Category	URL Category Abbreviation	Code
Search Engines	Sear	7503
Sports	Spor	10
Travel	Trav	11
Hobbies & Recreation	Hobb	12
Gambling	Gamb	13
Health & Medicine	Heal	14
News	News	20
Finance & Investment	Fina	25
Fashion & Beauty	Fash	9501
Kids Sites	Kids	7003
Government	Gove	40
Games	Game	1202
Arts	Arts	50
Entertainment	Ente	51
Chat	Chat	3001
Society & Culture	Soci	3003
Job Search & Career Development	Job	60
Religion	Reli	3006
Real Estate	Real	3010
Philanthropic & Professional Orgs.	Phil	9803
Education	Educ	70
Peer-to-Peer	Peer	9801
Infrastructure	Infr	9802

Table 14-7 URL Categories for IronPort URL Filters (Continued)

URL Category	URL Category Abbreviation	Code
Computing & Internet	Comp	75
Ringtones/Mobile Phone Downloads	Ring	9804
Motor Vehicles	Moto	1101
Politics	Poli	9806
Suspect/Threat URLs	Susp	9101
Hacking	Hack	7504
Sex Education	Sex	1490
Web-based E-mail	Web-	7507
Streaming Media	Stre	7509
Reference	Refe	7001
Adult/Sexually Explicit	Adul	90
Criminal Activity	Crim	91
Intolerance & Hate	Into	92
Violence	Viol	93
Weapons	Weap	94
Intimate Apparel & Swimwear	Inti	95
Personals & Dating	Pers	96
Photo Searches	Phot	97
Proxies & Translators	Prox	98
Hosting Sites	Host	99
Business	Busi	100
Shopping	Shop	80
Food & Dining	Food	3004
Blogs & Forums	Blog	2002

Table 14-7 URL Categories for IronPort URL Filters (Continued)

URL Category	URL Category Abbreviation	Code
Advertisements & Popups	Adve	76
Downloads	Down	7501
Illegal Drugs	Ille	1403
Alcohol & Tobacco	Alco	1404
Tasteless & Offensive	Tast	9301
URL Filtering Bypassed	-	1073741824
Uncategorized URLs	nc	1073741825
URL Filtering Bypassed	err	1073741826

Web Reputation Filters

This chapter contains the following information:

- “Web Reputation Filters Overview” on page 330
- “Web Reputation Scores” on page 331
- “How Web Reputation Filtering Works” on page 333
- “Configuring Web Reputation Scores” on page 335
- “Viewing Web Reputation Filtering Activity” on page 338

WEB REPUTATION FILTERS OVERVIEW

IronPort Web Reputation Filters is a security feature that analyzes web server behavior and assigns a reputation score to a URL to determine the likelihood that it contains URL-based malware. It helps protect against URL-based malware that threatens end-user privacy and sensitive corporate information. The Web Security appliance uses URL reputation scores to identify suspicious activity and stop malware attacks before they occur.

You can use Web Reputation Filters with both Access and Decryption Policies.

The Web Reputation Database

The Web Security appliance collects information and maintains a filtering database that contains aggregated traffic statistics, request attributes, and information about how different types of requests are handled. Additionally, the appliance can be configured to send web reputation statistics to a SenderBase server. SenderBase server information is leveraged with data feeds from the IronPort Common Security Database (SenderBase® Network) and the collective information is used to produce a Web Reputation Score.

Note — For more information, see “The SenderBase Network” on page 18.

Maintaining the Database Tables

The web reputation filtering component periodically receives updates to its database tables from the IronPort update server (<https://update-manifests.ironport.com>). Server updates are automated, and the update interval is set by the server as opposed to the appliance. Updates to the database tables occur with a regular degree of frequency, and require no administrator intervention.

For information about update intervals and the IronPort update server, see “Manually Updating Security Service Components” on page 545.

WEB REPUTATION SCORES

Web Reputation Filters use statistically significant data to assess the reliability of Internet domains and score the reputation of URLs. Data such as how long a specific domain has been registered, or where a web site is hosted, or whether a web server is using a dynamic IP address is used to judge the trustworthiness of a given URL.

The web reputation calculation associates a URL with network parameters to determine the probability that malware exists. The aggregate probability that malware exists is then mapped to a Web Reputation Score between -10 and +10, with +10 being the least likely to contain malware.

Example parameters include the following:

- URL categorization data
- Presence of downloadable code
- Presence of long, obfuscated End-User License Agreements (EULAs)
- Global volume and changes in volume
- Network owner information
- History of a URL
- Age of a URL
- Presence on any block lists
- Presence on any allow lists
- URL typos of popular domains
- Domain registrar information
- IP address information

Note — IronPort does not collect personally identifiable information such as usernames, passwords, or client IP addresses.

ENABLING WEB REPUTATION FILTERS

To use web reputation in policy groups, you must first enable Web Reputation Filters. By default, Web Reputation Filters are enabled in the System Setup Wizard. If it is not enabled in the System Setup Wizard, you can edit them in the web interface.

To enable Web Reputation Filters in the web interface:

1. Navigate to the Security Services > Web Reputation Filters page.

2. Click **Enable**.

The Web Reputation Filters License Agreement appears.

3. Read the terms of the Web Reputation Filters License Agreement, and click **Accept**.

4. Click **Edit Settings**.

The Edit Web Reputation Filters Settings page appears.

5. Verify the Enable Web Reputation Filters property is enabled.

6. Submit and commit your changes.

HOW WEB REPUTATION FILTERING WORKS

Web Reputation Scores are associated with an action to take on a URL request. The available actions depend on the policy group type that is assigned to the URL request:

- **Access Policies.** You can choose to block, scan, or allow.
- **Decryption Policies.** You can choose to drop, decrypt, or pass through.

You can configure each policy group to correlate an action to a particular Web Reputation Score.

Web Reputation in Access Policies

Table 15-1 describes the default Web Reputation Scores for Access Policies.

Table 15-1 Default Web Reputation Scores for Access Policies

Score	Action	Description	Example
-10 to -6.0	Block	Bad site. The request is blocked, and no further malware scanning occurs.	<ul style="list-style-type: none"> • URL downloads information without user permission. • Sudden spike in URL volume. • URL is a typo of a popular domain.
-5.9 to 5.9	Scan	Undetermined site. Request is passed to the DVS engine for further malware scanning. The DVS engine scans the request and server response content.	<ul style="list-style-type: none"> • Recently created URL that has a dynamic IP address and contains downloadable content. • Network owner IP address that has a positive Web Reputation Score.
6.0 to 10.0	Allow	Good site. Request is allowed. No malware scanning required.	<ul style="list-style-type: none"> • URL contains no downloadable content. • Reputable, high-volume domain with long history. • Domain present on several allow lists. • No links to URLs with poor reputations.

For example, by default, URLs in an HTTP request that are assigned a Web Reputation Score of +7 are allowed and require no further scanning. However, a weaker score for an HTTP request, such as +3, is automatically forwarded to the IronPort DVS engine where it is scanned for malware. Any URL in an HTTP request that has a very poor reputation is blocked.

Web Reputation in Decryption Policies

Table 15-2 describes the default Web Reputation Scores for Access Policies.

Table 15-2 Default Web Reputation Scores for Decryption Policies

Score	Action	Description
-10 to -9.0	Drop	Bad site. The request is dropped with no notice sent to the end user. Use this setting with caution.
-8.9 to 5.9	Decrypt	Undetermined site. Request is allowed, but the connection is decrypted and the decrypted traffic is applied to Access Policies. For more information about how the appliance decrypts HTTPS traffic, see "Decrypting HTTPS Traffic" on page 211.
6.0 to 10.0	Pass through	Good site. Request is passed through with no inspection or decryption.

CONFIGURING WEB REPUTATION SCORES

When you install and set up the Web Security appliance, it has default settings for Web Reputation Scores. However, you can modify threshold settings for web reputation scoring to fit your organization's needs.

You configure the web reputation filter settings for each policy group.

Configuring Web Reputation for Access Policies

To edit the web reputation filter settings for an Access Policy group:

1. Navigate to the Web Security Manager > Access Policies page.
2. Click the link under the Web Reputation and Anti-Malware Filtering column for the Access Policy group you want to edit.
3. Under the Web Reputation and Anti-Malware Settings section, choose "Define Web Reputation and Anti-Malware Custom Settings" from the drop down menu if it is not selected already.

Figure 15-1 Web Reputation Filter Settings for Access Policies

Access Policies: Reputation and Anti-Malware Settings: example1policy

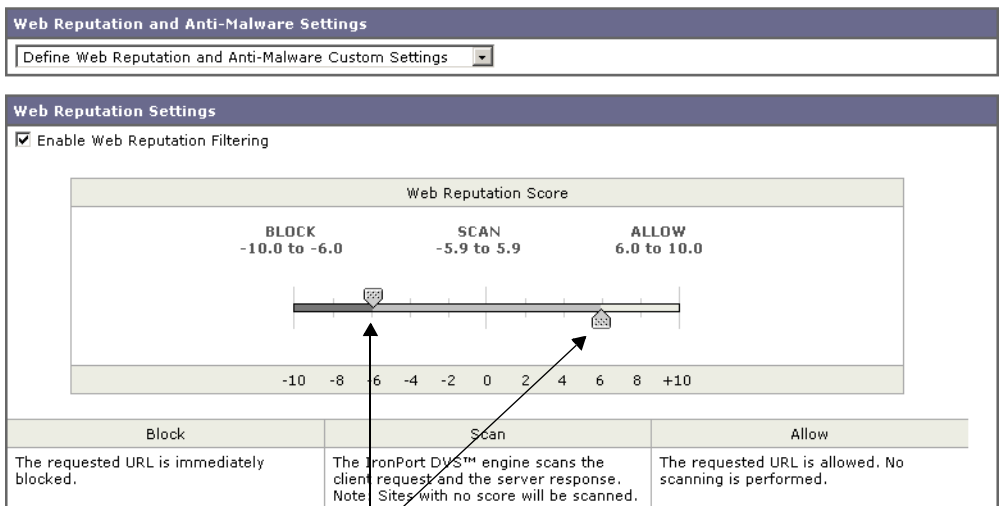

Move these markers to change the Web Reputation threshold values.

This allows you to override the web reputation and anti-malware settings from the Global Policy Group.

4. Verify the Enable Web Reputation Filtering field is enabled.
5. Move the markers to change the range for URL block, scan, and allow actions.
6. Submit and commit your changes.

Configuring Web Reputation for Decryption Policies

To edit the web reputation filter settings for a Decryption Policy group:

1. Navigate to the Web Security Manager > Decryption Policies page.
2. Click the link under the Web Reputation column for the Decryption Policy group you want to edit.
3. Under the Web Reputation Settings section, choose “Define Web Reputation Custom Settings” from the drop down menu if it is not selected already.

This allows you to override the override the web reputation settings from the Global Policy Group.

Figure 15-2 Web Reputation Filter Settings for Decryption Policies

HTTPS Decryption Policies: Reputation Settings: exampleDecryptionGroup

Web Reputation Settings
 Define Web Reputation Custom Settings

Enable Web Reputation Filtering

Web Reputation Score

DROP	DECRYPT	PASS THROUGH
-10.0 to -9.0	-8.9 to 5.9	6.0 to 10.0

-10 -8 -6 -4 -2 0 2 4 6 8 +10

Drop	Decrypt	Pass Through
The requested HTTPS connection is immediately dropped. No end-user notification will be provided. Use this setting with caution.	The HTTPS transaction will be decrypted for scanning and re-encrypted to ensure user privacy and security. The Scanning defined in the applicable Web Access Policy will be performed.	The HTTPS request is passed through without decryption. No scanning will be performed.

Sites with No Score
 Specify an action for sites that do not have a Web Reputation Score.

Sites with No Score: Use Global Settings (Monitor)

Move these markers to change the Web Reputation threshold values.

Choose action for sites with no assigned Web Reputation Score.

4. Verify the Enable Web Reputation Filtering field is checked.
5. Move the markers to change the range for URL drop, decrypt, and pass through actions.

6. In the Sites with No Score field, choose the action to take on request for sites that have no assigned Web Reputation Score.
7. Submit and commit your changes.

Configuring Web Reputation for IronPort Data Security Policies

Only negative and zero values can be configured for web reputation threshold settings for IronPort Data Security Policies. By definition, all positive scores are monitored.

To edit the web reputation filter settings for a Data Security Policy group:

1. Navigate to the Web Security Manager > IronPort Data Security Policies page.
2. Click the link under the Web Reputation column for the Data Security Policy group you want to edit.
3. Under the Web Reputation Settings section, choose “Define Web Reputation Custom Settings” from the drop down menu if it is not selected already.

Figure 15-3 Web Reputation Filter Settings for IronPort Data Security Policies

Ironport Data Security Policies: Reputation Settings: IDSPolicy1

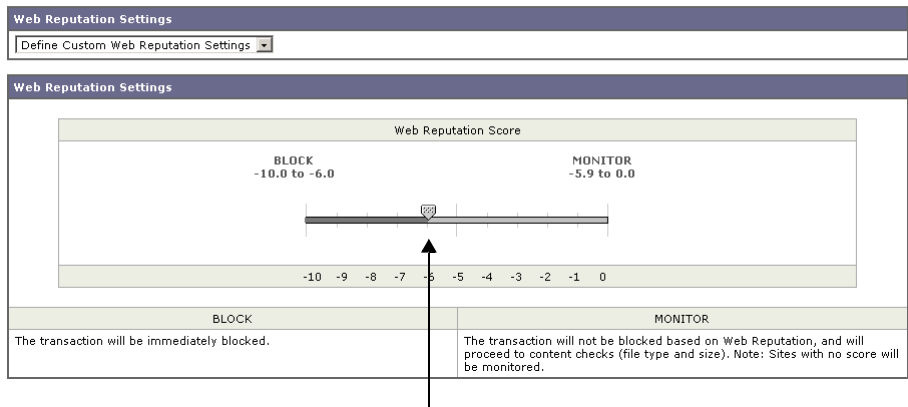

Move the marker to change the Web Reputation threshold value.

This allows you to override the web reputation settings from the Global Policy Group.

4. Move the marker to change the range for URL block and monitor actions.
For more information on these actions, see “Data Security Policy Groups” on page 236.
5. Submit and commit your changes.

VIEWING WEB REPUTATION FILTERING ACTIVITY

The S-Series appliance supports several options for generating feature specific reports, and displays of summary statistics.

Reports

You can use options on the Monitor > Reports pages of the web interface to select a type of report, capture data, schedule periodic email delivery, and archive reports.

For more information about working with reports, see “Reporting Overview” on page 434.

Monitoring Filter and Scoring Activity

The Monitor > Web Reputation page provides statistical displays of filtering activity. You can update these displays by specifying a time range of hour, day, week or month. Additionally, you have the option to print these display pages and export the raw data to a file.

You can use the following interactive displays and reporting tools to view the results of Web Reputation filtering and scoring activity:

Table 15-3 Web Reputation Filtering Reports

To view...	See...
Web reputation action and scoring activity	Monitor > Web Reputation Filters
Web reputation log files	System Administration > Log Subscriptions <ul style="list-style-type: none">• WBRS log files• Access log file

Access Log File

The access log file provides a record of filtering activity. You can examine entries in the access log file and trace web reputation processing specific to individual requests.

For more information about reading access log files, see “Access Log File” on page 456. For more an example access log entry that explains web reputation processing, see “Web Reputation Filters Example” on page 465.

Anti-Malware Services

This chapter contains the following information:

- “Anti-Malware Overview” on page 340
- “IronPort DVS™ (Dynamic Vectoring and Streaming) Engine” on page 342
- “Webroot Scanning” on page 345
- “McAfee Scanning” on page 346
- “Configuring Anti-Malware Scanning” on page 348
- “Viewing Anti-Malware Scanning Activity” on page 352

ANTI-MALWARE OVERVIEW

The Web Security appliance anti-malware feature is a security component that uses the IronPort DVS™ engine in combination with the Webroot™ and McAfee technology to identify and stop a broad range of web-based malware threats.

For more information about the DVS engine, see “IronPort DVS™ (Dynamic Vectoring and Streaming) Engine” on page 342.

To use the anti-malware component of the appliance, you must first configure global settings and then apply specific settings to different policies. For more information about configuring the appliance for anti-malware scanning, see “Configuring Anti-Malware Scanning” on page 348.

You can also view the anti-malware scanning activity in reports and in the Web Security Monitor. For more information, see “Viewing Anti-Malware Scanning Activity” on page 352.

Malware Category Descriptions

Table 16-1 describes the different categories of malware the Web Security appliance can block.

Table 16-1 Malware Category Descriptions

Malware Type	Description
Adware	Adware encompasses all software executables and plug-ins that direct users towards products for sale. Some adware applications have separate processes that run concurrently and monitor each other, ensuring that the modifications are permanent. Some variants enable themselves to run each time the machine is started. These programs may also change security settings making it impossible for users to make changes to their browser search options, desktop, and other system settings.
Browser Helper Object	A browser helper object is browser plug-in that may perform a variety of functions related to serving advertisements or hijacking user settings.
Commercial System Monitor	A commercial system monitor is a piece of software with system monitor characteristics that can be obtained with a legitimate license through legal means.
Dialer	A dialer is a program that utilizes your modem or another type of Internet access to connect you to a phone line or a site that causes you to accrue long distance charges to which you did not provide your full, meaningful, and informed consent.
Hijacker	A hijacker modifies system settings or any unwanted changes to a user's system that may direct them to a website or run a program without a user's full, meaningful, and informed consent.

Table 16-1 Malware Category Descriptions (Continued)

Malware Type	Description
Phishing URL	A phishing URL is displayed in the browser address bar. In some cases, it involves the use of domain names and resembles those of legitimate domains. Phishing is a form of online identity theft that employs both social engineering and technical subterfuge to steal personal identity data and financial account credentials.
System Monitor	A system monitor encompasses any software that performs one of the following actions: <ul style="list-style-type: none"> • Overtly or covertly records system processes and/or user action. • Makes those records available for retrieval and review at a later time.
Trojan Downloader	A trojan downloader is a Trojan that, after installation, contacts a remote host/site and installs packages or affiliates from the remote host. These installations usually occur without the user's knowledge. Additionally, a Trojan Downloader's payload may differ from installation to installation since it obtains downloading instructions from the remote host/site.
Trojan Horse	A trojan horse is a destructive program that masquerades as a benign application. Unlike viruses, Trojan horses do not replicate themselves.
Trojan Phisher	A trojan phisher may sit on an infected computer waiting for a specific web page to be visited or may scan the infected machine looking for user names and passwords for bank sites, auction sites, or online payment sites.
Virus	A virus is a program or piece of code that is loaded onto your computer without your knowledge and runs against your wishes.
Worm	A worm is program or algorithm that replicates itself over a computer network and usually performs malicious actions.

IRONPORT DVS™ (DYNAMIC VECTORING AND STREAMING) ENGINE

The IronPort Dynamic Vectoring and Streaming (DVS) engine inspects web traffic to provide protection against the widest variety of web-based malware ranging from commercially invasive adware applications, to malicious trojans, system monitors, and phishing attacks.

To configure the DVS engine, and Webroot and McAfee global settings, see “Configuring Anti-Malware Scanning” on page 348.

The IronPort DVS engine can use one or more scanning engines to determine malware risk. Depending on the features purchased with the appliance, you can enable any of the following scanning engines:

- **Webroot.** Webroot’s automated spyware detection system rapidly identifies existing and new spyware threats on the Internet by intelligently scanning millions of sites on a daily basis. Webroot uses a signature database to help detect threats on the Internet. For more information about the Webroot scanning engine, see “Webroot Scanning” on page 345.
- **McAfee.** The McAfee scanning engine can detect existing and new malware threats by using a signature database of malware information and heuristic analysis. For more information about the McAfee scanning engine, see “McAfee Scanning” on page 346.

The scanning engines inspect URL transactions to determine a malware scanning verdict to pass to the DVS engine. A malware scanning verdict is a value assigned to a URL request or server response that determines the probability that it contains malware. The DVS engine determines whether to monitor or block the request based on the malware scanning verdicts. For more information about malware scanning verdicts, see “Malware Scanning Verdict Values” on page 480.

In some cases, the DVS engine might determine multiple verdicts for a single URL. For more information about how the DVS handles multiple verdicts, see “Working with Multiple Malware Verdicts” on page 343.

Maintaining the Database Tables

The Webroot and McAfee databases periodically receive updates from the IronPort update server (<https://update-manifests.ironport.com>). Server updates are automated, and the update interval is set by the server, not the appliance. Updates to the database tables occur with a regular degree of frequency, and require no administrator intervention.

For information about update intervals and the IronPort update server, see “Manually Updating Security Service Components” on page 545.

How the DVS Engine Works

The DVS engine performs anti-malware scanning on URL transactions that are forwarded from the Web Reputation Filters. Web Reputation Filters calculate the probability that a particular URL contains malware, and assign a URL score that is associated with an action to block, scan, or allow the transaction.

When the assigned web reputation score indicates to scan the transaction, the DVS engine receives the URL request and server response content. The DVS engine, in combination with the Webroot and/or McAfee scanning engines, returns a malware scanning verdict. The DVS engine uses information from the malware scanning verdicts and Access Policy settings to determine whether to block or deliver the content to the client.

When you enable both Webroot and McAfee, the DVS engine determines how to scan the content to optimize performance and efficacy.

Working with Multiple Malware Verdicts

In some cases, the DVS engine might determine multiple malware verdicts for a single URL. Multiple verdicts can come from one or both scanning engines:

- **Different verdicts from different scanning engines.** When you enable both Webroot and McAfee, each scanning engine might return different malware verdicts for the same object.
- **Different verdicts from the same scanning engine.** A scanning engine might return multiple verdicts for a single object when the object contains multiple infections. For example, a zip file might contain multiple files, each infected with a different kind of malware.

When a URL causes multiple verdicts, the appliance takes different action depending on whether one or both scanning engines return the multiple malware verdicts.

Different Scanning Engines

When a URL causes multiple verdicts from both scanning engines, the appliance performs the most restrictive action. For example, if one scanning engine returns a block verdict and the other a monitor verdict, the DVS engine always blocks the request. Only the most restrictive verdict is logged and reported.

Same Scanning Engine

When a URL causes multiple verdicts from the same scanning engine, the appliance takes action according to the verdict with the highest priority. Only the highest verdict is logged and reported. The following text lists the possible malware scanning verdicts from the highest to the lowest priority.

- Virus
- Trojan Downloader
- Trojan Horse
- Trojan Phisher
- Hijacker
- System monitor
- Commercial System Monitor

- Dialer
- Worm
- Browser Helper Object
- Phishing URL
- Adware
- Encrypted file
- Unscannable
- Other Malware

Suppose the McAfee scanning engine detects both adware and a virus in the scanned object, and that the appliance is configured to block adware and monitor viruses. According to the list above, viruses belong in a higher priority verdict category than adware. Therefore, the appliance *monitors* the object and reports the verdict as virus in the reports and logs. It does not block the object even though it is configured to block adware.

WEBROOT SCANNING

The Webroot scanning engine inspects objects to determine the malware scanning verdict to send to the DVS engine. The Webroot scanning engine inspects the following objects:

- **URL request.** Webroot evaluates a URL request to determine if the URL is a malware suspect. If Webroot suspects the response from this URL might contain malware, the appliance monitors or blocks the request, depending on how the appliance is configured. If Webroot evaluation clears the request, the appliance retrieves the URL and scans the server response.
- **Server response.** When the appliance retrieves a URL, Webroot scans the server response content and compares it to the Webroot signature database.

For more information about how the DVS engine uses malware scanning verdicts to handle web traffic, see “IronPort DVS™ (Dynamic Vectoring and Streaming) Engine” on page 342.

For information about Web Reputation Filtering and URL scores, see “Web Reputation Filters” on page 329.

McAFEE SCANNING

The McAfee scanning engine inspects objects downloaded from a web server in HTTP responses. After inspecting the object, it passes a malware scanning verdict to the DVS engine so the DVS engine can determine whether to monitor or block the request.

The McAfee scanning engine uses the following methods to determine the malware scanning verdict:

- Matching virus signature patterns
- Heuristic analysis

For more information about how the DVS engine uses malware scanning verdicts to handle web traffic, see “IronPort DVS™ (Dynamic Vectoring and Streaming) Engine” on page 342.

Matching Virus Signature Patterns

McAfee uses virus definitions in its database with the scanning engine to detect particular viruses, types of viruses, or other potentially unwanted software. It searches for virus signatures in files.

When you enable McAfee, the McAfee scanning engine always uses this method to scan server response content.

Heuristic Analysis

New threats on the web appear almost daily. Using only virus signatures, the engine cannot detect a new virus or other malware because its signature is not yet known. However, by using heuristic analysis, the McAfee scanning engine can detect new classes of currently unknown viruses and malware in advance.

Heuristic analysis is a technique that uses general rules, rather than specific rules, to detect new viruses and malware. When the McAfee scanning engine uses heuristic analysis, it looks at the code of an object, applies generic rules, and determines how likely the object is to be virus-like.

Using heuristic analysis increases the likelihood of catching viruses and malware before McAfee updates its virus signature database. However, it also increases the possibility of reporting false positives (clean content designated as a virus). It also might impact appliance performance.

When you enable McAfee, you can choose whether or not to also enable heuristic analysis when scanning objects.

McAfee Categories

Table 16-2 lists the McAfee verdicts and how they correspond to malware scanning verdict categories.

Table 16-2 Appliance Categories for McAfee Verdicts

McAfee Verdict	Malware Scanning Verdict Category
Known Virus	Virus
Trojan	Trojan Horse
Joke File	Adware
Test File	Virus
Wannabe	Virus
Killed	Virus
Commercial Application	Commercial System Monitor
Potentially Unwanted Object	Adware
Potentially Unwanted Software Package	Adware
Encrypted File	Encrypted File

For a list of malware scanning verdicts, see “Malware Scanning Verdict Values” on page 480.

CONFIGURING ANTI-MALWARE SCANNING

The DVS engine and Webroot and McAfee are enabled by default during system setup. Anytime after system setup, you can configure the anti-malware settings for the Web Security appliance. You configure the following anti-malware settings:

- **Global anti-malware settings.** Set object scanning parameters, specify global settings for URL matching, and control when to block the URL or allow processing to continue.
- **Access Policy anti-malware settings.** Enable monitoring or blocking for malware categories based on malware scanning verdicts.

To configure anti-malware settings:

1. On the Security Services > Anti-Malware page, click **Edit Global Settings**.

The Edit Anti-Malware Settings page appears.

2. Configure the anti-malware settings as necessary. Table 16-3 describes the anti-malware settings you can configure.

Table 16-3 Anti-Malware Settings

Setting	Description
Object Scanning Limits	Specify a maximum request/response size and timeout value for single objects. The Maximum Object Size value you specify applies to the entire size of requests and responses that might be scanned by security components on the Web Security appliance, such as the IronPort Data Security Filters or the Webroot scanning engine. When an upload or download size exceeds this size, the security component may abort the scan in progress and may not provide a scanning verdict to the Web Proxy.
Domain Levels for Malware Request Detection	This value specifies the number of domain name elements to match when processing a URL. If the URL matches a hostname in the Webroot signature database, URL checking continues to match the number of domain name elements specified in this parameter. Valid range for this parameter is 3-100 where a minimum value of 8 is recommended to avoid a level of matching that results in inaccurately blocked web sites. Applies to the Webroot scanning engine only.

Table 16-3 Anti-Malware Settings (Continued)

Setting	Description
Threat Risk Threshold	<p>The TRT (Threat Risk Threshold) assigns a numerical value to the probability that malware exists.</p> <p>Proprietary algorithms evaluate the result of a URL matching sequence and assign a TRR (Threat Risk Rating). This value is associated with the threat risk threshold setting. If the TRR value is greater than or equal to the TRT, the URL is considered malware and is passed on for further processing.</p> <p>Note: Setting the Threat Risk Threshold to a value lower than 90 dramatically increases the rate of URL blocking and denies legitimate requests. IronPort strongly recommends maintaining the TRT default value of 90. The minimum value for a TRT setting is 51.</p> <p>Applies to the Webroot scanning engine only.</p>
Heuristic Scanning	<p>Choose whether or not to enable heuristic scanning for the McAfee scanning engine.</p> <p>For more information about heuristic scanning, see “McAfee Scanning” on page 346.</p> <p>Note: Heuristic analysis increases security protection, but can result in false positives and decreased performance.</p> <p>Applies to the McAfee scanning engine only.</p>

3. Submit and commit your changes.
4. Navigate to the Web Security Manager > Access Policies page.
5. Click the Web Reputation and Anti-Malware Filtering link for the Access Policy you want to configure.

On this page, you can enable monitoring or blocking for malware categories based on malware scanning verdicts.

6. Under the “Web Reputation and Anti-Malware Settings” section, choose Define Web Reputation and Anti-Malware Custom Settings if it is not chosen already.

Web Access Policies: Reputation and Anti-Malware Settings: groupAuthPolicy



This allows you to configure web reputation and anti-malware settings for this Access Policy that differ from the global policy.

7. Scroll down to the Ironport DVS Anti-Malware Settings section.

Figure 16-1 Access Policy Anti-Malware Settings

Ironport DYS Anti-Malware Settings		
<input checked="" type="checkbox"/> Enable Suspect User Agent Scanning <input checked="" type="checkbox"/> Enable Webroot <input checked="" type="checkbox"/> Enable McAfee		
Malware Categories	Monitor	Block
Adware	<input checked="" type="checkbox"/>	
Browser Helper Object	<input checked="" type="checkbox"/>	
Commercial System Monitor	<input checked="" type="checkbox"/>	
Dialer	<input checked="" type="checkbox"/>	
Hijacker	<input checked="" type="checkbox"/>	
Phishing URL	<input checked="" type="checkbox"/>	
System Monitor	<input checked="" type="checkbox"/>	
Trojan Downloader	<input checked="" type="checkbox"/>	
Trojan Horse	<input checked="" type="checkbox"/>	
Trojan Phisher	<input checked="" type="checkbox"/>	
Virus	<input checked="" type="checkbox"/>	
Worm	<input checked="" type="checkbox"/>	
Other Malware <i>(May include Worms, Trojans and other dangerous forms of malware.)</i>	<input checked="" type="checkbox"/>	
Additional Scanning	Monitor	Block
Encrypted File	<input checked="" type="checkbox"/>	
Suspect User Agents	<input checked="" type="checkbox"/>	
Unscannable	<input checked="" type="checkbox"/>	

- Configure the anti-malware settings for the policy as necessary. Table 16-4 describes the anti-malware settings you can configure for Access Policies.

Table 16-4 Anti-Malware Settings for Access Policies

Setting	Description
Enable Suspect User Agent Scanning	Choose whether or not to enable the appliance to scan traffic based on the user agent field specified in the HTTP request header. When you check this setting, you can choose to monitor or block suspect user agents in the Additional Scanning section at the bottom of the page.
Enable Webroot	Choose whether or not to enable the appliance to use the Webroot scanning engine when scanning traffic. When you enable Webroot scanning, you can choose to monitor or block some additional categories in the Malware categories on this page.

Table 16-4 Anti-Malware Settings for Access Policies (Continued)

Setting	Description
Enable McAfee	Choose whether or not to enable the appliance to use the McAfee scanning engine when scanning traffic. When you enable McAfee scanning, you can choose to monitor or block some additional categories in the Malware categories on this page.
Malware Categories	Choose whether to monitor or block the various malware categories based on a malware scanning verdict. The categories listed in this section depend on which scanning engines you enable above.
Additional Scanning	Choose whether to monitor or block the types of objects and responses listed in this section. Note: URL transactions are categorized as unscannable when the configured maximum time setting is reached or when the system experiences a transient error condition. For example, transactions might be categorized as unscannable during scanning engine updates or AsyncOS upgrades. The malware scanning verdicts SV_TIMEOUT and SV_ERROR, are considered unscannable transactions.

9. Submit and commit your changes.

VIEWING ANTI-MALWARE SCANNING ACTIVITY

The Web Security appliance supports several options for generating feature specific reports, and interactive displays of summary statistics.

Reports

You can use options on the Monitor > Reports pages of the web interface to select a type of report, capture data, schedule periodic email delivery, and archive reports.

For more information about working with reports, see “Reporting Overview” on page 434.

Monitoring Scanning Activity

The Monitor > Anti-Malware page provides statistical displays of malware scanning activity. You can update these displays by specifying a time range of hour, day, week or month. Additionally, you have the option to print these display pages and export the raw data to a file. You can use the following interactive displays and reporting tools to view the results of anti-malware scanning and related activity:

Table 16-5 Anti-Malware Scanning Reports

To View...	See...
Top anti-malware sites	Monitor > Overview
Top malware categories and threats	Monitor > Anti-Malware
Anti-malware log files	System Administration > Log Subscriptions <ul style="list-style-type: none">• Webroot log files• McAfee log files• Access log file

Access Log File

The access log file provides a record of anti-malware scanning activity. You can examine entries in the access log file and trace the result of malware scanning for individual requests. For more information about reading access log files, see “Access Log File” on page 456.

Authentication

This chapter contains the following information:

- “Authentication Overview” on page 354
- “How Authentication Works” on page 357
- “Working with Authentication Realms” on page 364
- “Working with Authentication Sequences” on page 366
- “Appliance Behavior with Multiple Authentication Realms” on page 369
- “Testing Authentication Settings” on page 370
- “Configuring Global Authentication Settings” on page 373
- “Allowing Users to Re-Authenticate” on page 386
- “Tracking Authenticated Users” on page 389
- “LDAP Authentication” on page 390
- “NTLM Authentication” on page 396
- “Supported Authentication Characters” on page 401

AUTHENTICATION OVERVIEW

Authentication is the act of confirming the identity of a user. By using authentication in the Web Security appliance, you can control access to the Web for each user or a group of users. This allows you to enforce the organization's policies and comply with regulations. When you enable authentication, the Web Security appliance authenticates clients on the network before allowing them to connect to a destination server.

The Web Security appliance supports the following authentication protocols:

- **Lightweight Directory Access Protocol (LDAP).** The appliance supports standard LDAP server authentication and secure LDAP authentication. You can use a Basic authentication scheme. For more information about LDAP configuration options, see "LDAP Authentication" on page 390.
- **NT Lan Manager (NTLM).** The appliance supports NTLM to enable authentication between the appliance and a Microsoft Windows domain controller. You can use either NTLMSSP or Basic authentication schemes. For more information about NTLM configuration options, see "NTLM Authentication" on page 396.

To enable authentication, you must create at least one authentication realm. An authentication realm is a set of authentication servers (or a single server) supporting a single authentication protocol with a particular configuration. For more information about authentication realms, see "Working with Authentication Realms" on page 364.

When you create more than one realm, you can group the realms into an authentication sequence. An authentication sequence is a group of authentication realms listed in the order the Web Security appliance uses for authenticating clients. For more information about authentication sequences, see "Working with Authentication Sequences" on page 366.

You configure some authentication options at a global level, independent of any realm. For more information, see "Configuring Global Authentication Settings" on page 373.

By creating authentication realms and sequences, you can configure the Web Security appliance to use one or more authentication servers for authenticating clients on the network. For more information about how the appliance works when it uses multiple authentication servers, see "Appliance Behavior with Multiple Authentication Realms" on page 369.

After creating an authentication realm and possibly a sequence, too, you can create or edit Identities based on authentication realms or sequences. Note, however, that if you delete an authentication realm or sequence, any Identity group that depends on the deleted realm or sequence becomes disabled. For more information about using authentication with Identities, see "How Authentication Affects Identity Groups" on page 148.

Client Application Support

When the Web Security appliance is deployed in transparent mode and a transaction requires authentication, the Web Proxy replies to the client application asking for authentication credentials. However, not all client applications support authentication, so they have no

method for prompting users to provide their user names and passwords. These applications cannot be used when the Web Security appliance is deployed in transparent mode.

The following is a partial list of applications that do not work when the appliance is deployed in transparent mode:

- Mozilla Thunderbird
- Adobe Acrobat Updates
- HttpBridge
- Subversion, by CollabNet
- Microsoft Windows Update
- Microsoft Visual Studio

Note — If users need to access a particular URL using one of these client applications, then create an Identity based on a custom URL category that does not require authentication and place the Identity above all other Identities that require authentication. When you do this, the client application will not be asked for authentication.

Working with Upstream Proxy Servers

When the Web Security appliance is connected to an upstream proxy server, you can configure the appliance or the upstream proxy to use authentication, but not both. IronPort recommends configuring the Web Security appliance to use authentication. This allows you to create policies based on user authentication.

If both the appliance and the upstream proxy use authentication, depending on the configurations, the appliance and upstream proxy might engage in an infinite loop of requesting authentication credentials. For example, if the upstream proxy requires Basic authentication, but the appliance requires NTLMSSP authentication, then the appliance can never successfully pass Basic credentials to the upstream proxy. This is due to limitations in authentication protocols.

Authenticating Users

When users access the web through the Web Security appliance, they might get prompted to enter a user name and password. The Web Proxy requires authentication credentials for some users depending on the configured Identity and Access Policy groups. Users should enter the user name and password of the credentials recognized by the organization's authentication server.

When the Web Proxy uses NTLMSSP authentication with an NTLM authentication realm, users are typically not prompted to enter a user name and password if single sign-on is configured correctly. However, if users are prompted for authentication, they must type the name of their Windows domain before their user name. For example, if user jsmith is on Windows domain MyDomain, then the user should type the following text in the user name field:

MyDomain\jsmith

However, if the Web Proxy uses Basic authentication for an NTLM authentication realm, then entering the Windows domain is optional. If the user does not enter the Windows domain, then the Web Proxy prepends the default Windows domain.

Note — When the Web Proxy uses authentication with an LDAP authentication realm, ensure users do not enter the Windows domain name.

Working with Failed Authentication

Sometimes users are blocked from the web due to authentication failure. The following list describes reasons for authentication failure and remedial actions you can take:

- **Client application cannot perform authentication.** Some clients cannot perform authentication or cannot perform the type of authentication that is required. If a client application causes authentication to fail, you can define an Identity policy based on the user agent and exclude it from requiring authentication. Or, you can define an Identity policy based on a custom URL category to exclude all clients from requiring authentication when accessing particular URLs.
- **Authentication server is unavailable.** An authentication server might be unavailable if the network connection is broken or if the server is experiencing a problem. To avoid this problem, configure the “Action if Authentication Service Unavailable” global authentication setting. For more information, see “Configuring Global Authentication Settings” on page 373.
- **Invalid credentials.** When a client passes invalid authentication credentials, the Web Proxy continually requests valid credentials, essentially blocking access to the web by default. However, you can grant limited access to users who fail authentication. For more information, see “Allowing Guest Access to Users Who Fail Authentication” on page 155.

Note — You can configure the Web Proxy to request authentication again if an authenticated user is blocked from a website due to restrictive URL filtering. To do this, enable the “Enable Re-Authentication Prompt If End User Blocked by URL Category” global authentication setting. For more information, see “Allowing Users to Re-Authenticate” on page 386.

HOW AUTHENTICATION WORKS

To authenticate users who access the web, the Web Security appliance connects to an external authentication server. The authentication server contains a list of users and their corresponding passwords and it organizes the users into a hierarchy. For users on the network to successfully authenticate, they must provide valid authentication credentials (user name and password as stored in the authentication server).

When users access the web through a Web Security appliance that requires authentication, the Web Proxy asks the client for authentication credentials. The Web Proxy communicates with both the client and the authentication server to authenticate the user and process the request.

Figure 17-1 shows how the Web Security appliance communicates with clients and authentication servers.

Figure 17-1 Web Security Appliance Authentication

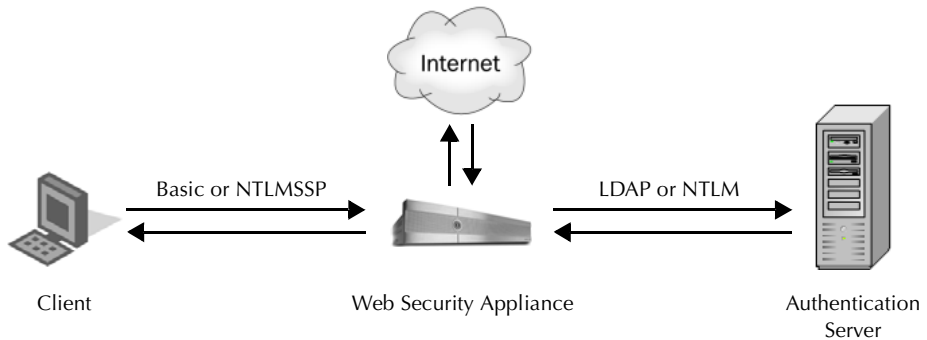

The Web Security appliance supports the following authentication protocols:

- **Lightweight Directory Access Protocol (LDAP).** The Web Proxy uses the LDAP Bind operation to query an LDAP-compatible authentication server. The appliance supports standard LDAP server authentication and secure LDAP authentication.

For more information about LDAP configuration options, see “LDAP Authentication” on page 390.

- **NT LAN Manager (NTLM).** The Web Proxy uses NTLM, a Microsoft proprietary protocol, to authenticate users which exist in Microsoft Active Directory. The NTLM protocol uses a challenge-response sequence of messages between the client and the Active Directory server. You can use either NTLMSSP or Basic authentication schemes on client side.

For more information about NTLM configuration options, see “NTLM Authentication” on page 396.

In addition to the preceding protocols, the Web Security appliance supports the following client side authentication schemes:

- **Basic.** Allows a client application to provide authentication credentials in the form of a user name and password when it makes a request. You can use the Basic authentication scheme with either an LDAP or Active Directory server.
- **NTLMSSP.** Allows the client application to provide authentication credentials in the form of a challenge and response. It uses a binary message format to authenticate clients that use the NTLM protocol to access network resources. You can use the NTLMSSP authentication scheme only with an Active Directory server. When the Web Proxy uses NTLMSSP, most client applications can use the Windows login credentials for authentication and users do not need to enter their credentials again. This is called “single sign-on.”

For more information, see “Basic versus NTLMSSP Authentication Schemes” on page 358.

Table 17-1 describes the different authentication scenarios you can configure between the Web Security appliance and the client and between the Web Security appliance and the authentication server.

Table 17-1 Web Security Appliance Authentication Scenarios

Client to Web Security Appliance	Web Security Appliance to Authentication Server	Authentication Server Type
Basic	LDAP	LDAP server
Basic	LDAP	Active Directory server using LDAP
Basic	NTLM	Active Directory server using NTLM
NTLMSSP	NTLM	Active Directory server using NTLM

Web Proxy deployment also affects how authentication works in each of the scenarios described in Table 17-1. For more information, see “How Web Proxy Deployment Affects Authentication” on page 359.

Basic versus NTLMSSP Authentication Schemes

When you configure an Identity group to use authentication, you choose the authentication scheme, either Basic or NTLMSSP. The authentication scheme affects the user experience and the security of users’ passwords.

Table 17-2 describes the differences between Basic and NTLMSSP authentication schemes.

Table 17-2 Basic versus NTLMSSP Authentication Schemes

Authentication Scheme	User Experience	Security
Basic	The client always prompts users for credentials. After the user enters credentials, browsers typically offer a check box to remember the provided credentials. Each time the user opens the browser, the client either prompts for credentials or resends the previously saved credentials.	Credentials are sent <i>unsecured</i> as clear text (Base64). A packet capture between the client and Web Security appliance can reveal the user name and password. Note: You can configure the Web Security appliance so clients send authentication credentials securely. For more information, see “Sending Authentication Credentials Securely” on page 383.
NTLMSSP	The client transparently authenticates by using its Windows login credentials. The user is not prompted for credentials. However, the client prompts the user for credentials under the following circumstances: <ul style="list-style-type: none"> • The Windows credentials failed. • The client does not trust the Web Security appliance because of browser security settings. 	Credentials are sent <i>securely</i> using a three-way handshake (digest style authentication). The password is never sent across the connection. For more information on the three-way handshake, see “Explicit Forward Deployment, NTLM Authentication” on page 362.

How Web Proxy Deployment Affects Authentication

The Web Proxy communicates with clients and authentication servers differently depending on the type of Web Proxy deployment and the authentication protocol.

Table 17-3 lists the possible methods of authentication for the various authentication protocols and deployment type.

Table 17-3 Methods of Authentication

Web Proxy Deployment	Client to Web Security Appliance	Web Security Appliance to Authentication Server
Explicit forward	Basic	LDAP or NTLM Basic
Transparent	Basic	LDAP or NTLM Basic

Table 17-3 Methods of Authentication (Continued)

Web Proxy Deployment	Client to Web Security Appliance	Web Security Appliance to Authentication Server
Explicit forward	NTLM	NTLMSSP
Transparent	NTLM	NTLMSSP

The following subsections describe these methods of authentication in more detail.

Explicit Forward Deployment, Basic Authentication

When a client explicitly sends a web page request to a Web Security appliance deployed in explicit forward mode, the Web Proxy can reply to the client with a 407 HTTP response “Proxy Authentication Required.” This status informs the client that it must supply valid authentication credentials to access web resources.

The authentication process comprises these steps:

1. Client sends a request to the Web Proxy to connect to a web page.
2. Web Proxy responds with a 407 HTTP response “Proxy Authentication Required.”
3. User enters credentials, and client application resends the original request with the credentials encoded in Base64 (not encrypted) in a “Proxy-Authorization” HTTP header.
4. Web Proxy verifies the credentials and returns the requested web page.

Table 17-4 lists advantages and disadvantages of using explicit forward Basic authentication.

Table 17-4 Pros and Cons of Explicit Forward Basic Authentication

Advantages	Disadvantages
<ul style="list-style-type: none"> • RFC-based • Supported by all browsers and most other applications • Minimal overhead • Works for HTTPS (CONNECT) requests 	<ul style="list-style-type: none"> • Password sent as clear text (Base64) for every request • No single sign-on

Transparent Deployment, Basic Authentication

The 407 HTTP response “Proxy Authentication Required” is allowed from proxy servers only. However, when the Web Proxy is deployed in transparent mode, its existence is hidden from client applications on the network. Therefore, the Web Proxy cannot return a 407 response.

To address this problem, the authentication process comprises these steps:

1. Client sends a request to a web page and the Web Proxy transparently intercepts it.

2. Web Proxy uses a 307 HTTP response to redirect the client to the Web Proxy which masquerades as a local web server.
3. Client sends a request to the redirected URL.
4. Web Proxy sends a 401 HTTP response "Authorization required."
5. User is prompted for credentials and enters them.
6. Client sends the request again, but this time with the credentials in an "Authorization" HTTP header.
7. Web Proxy confirms the credentials, tracks the user by IP address or with a cookie, and then redirects the client to the originally requested server.

Note — You can configure the Web Proxy to use either IP addresses or cookies to track authenticated users.

8. If the client requests the original web page again, the Web Proxy transparently intercepts the request, confirms the user by IP address or cookie, and returns the requested page.

Note — If the client tries to connect to another web page and the Web Proxy tracked the user by IP address, the Web Proxy confirms the user by IP address and returns the requested page.

Table 17-5 lists advantages and disadvantages of using transparent Basic authentication and IP-based credential caching.

Table 17-5 Pros and Cons of Transparent Basic Authentication—IP Caching

Advantages	Disadvantages
<ul style="list-style-type: none"> • Works with all major browsers • With user agents that do not support authentication, users only need to authenticate first in a supported browser • Relatively low overhead • Works for HTTPS requests if the user has previously authenticated with an HTTP request 	<ul style="list-style-type: none"> • Authentication credentials are associated with the IP address, not the user (does not work in Citrix and RDP environments, or if the user changes IP address) • No single sign-on • Password is sent as clear text (Base64)

Table 17-6 lists advantages and disadvantages of using transparent Basic authentication and cookie-based credential caching.

Table 17-6 Pros and Cons of Transparent Basic Authentication—Cookie Caching

Advantages	Disadvantages
<ul style="list-style-type: none"> • Works with all major browsers • Authentication is associated with the user rather than the host or IP address 	<ul style="list-style-type: none"> • Each new web domain requires the entire authentication process because cookies are domain specific • Requires cookies to be enabled • Does not work for HTTPS requests • No single sign-on • Password is sent as clear text (Base64)

Explicit Forward Deployment, NTLM Authentication

The Web Proxy uses a third party challenge and response system to authenticate users on the network.

The authentication process comprises these steps:

1. Client sends a request to the Web Proxy to connect to a web page.
2. Web Proxy responds with a 407 HTTP response “Proxy Authentication Required.”
3. Client repeats request and includes a “Proxy-Authorization” HTTP header with an NTLM “negotiate” message.
4. Web Proxy responds with a 407 HTTP response and an NTLM “challenge” message based on the negotiate message from the client.
5. Client repeats the request and includes a response to the challenge message.

Note — The client uses an algorithm based on its password to modify the challenge and sends the challenge response to the Web Proxy.

6. Web Proxy passes the authentication information to the Active Directory server. The Active Directory server then verifies that the client used the correct password based on whether or not it modified the challenge string appropriately.
7. If the challenge response passes, the Web Proxy returns the requested web page.

Note — Additional requests *on the same TCP connection* do not need to be authenticated again with the Active Directory server.

Table 17-7 lists advantages and disadvantages of using explicit forward NTLM authentication.

Table 17-7 Pros and Cons of Explicit Forward NTLM Authentication

Advantages	Disadvantages
<ul style="list-style-type: none"> • Because the password is not transmitted to the authentication server, it is more secure • Connection is authenticated, not the host or IP address • Achieves true single sign-on in an Active Directory environment when the client applications are configured to trust the Web Security appliance 	<ul style="list-style-type: none"> • Moderate overhead: each new connection needs to be re-authenticated • Primarily supported on Windows only and with major browsers only

Transparent Deployment, NTLM Authentication

Transparent NTLM authentication is similar to transparent Basic authentication except that the Web Proxy communicates with clients using NTLMSSP instead of Basic. However, with transparent NTLM authentication, the authentication credentials are not sent in the clear to the authentication server.

For more information, see “Transparent Deployment, Basic Authentication” on page 360.

The advantages and disadvantages of using transparent NTLM authentication are the same as those of using transparent Basic authentication except that transparent NTLM authentication is better because the password is not sent to the authentication server and you can achieve single sign-on when the client applications are configured to trust the Web Security appliance. For more information on the advantages and disadvantages of transparent Basic authentication, see Table 17-5 on page 361 Table 17-6 on page 362.

WORKING WITH AUTHENTICATION REALMS

An authentication realm is a set of authentication servers (or a single server) supporting a single authentication protocol with a particular configuration.

You can perform any of the following tasks when configuring authentication:

- Include up to three authentication servers in a realm.
- Create zero or more LDAP realms.
- Create zero or one NTLM realm.
- Include an authentication server in multiple realms.
- Include one or more realms in an authentication sequence.
- Include realms of different protocols in a single authentication sequence.
- Assign a realm or a sequence to an Access Policy group.

You create, edit, and delete authentication realms on the Network > Authentication page under the Authentication Realms section. Figure 17-2 shows where you define authentication realms.

Figure 17-2 Authentication Page — Authentication Realms

Authentication

Authentication Realms	
<input type="button" value="Add Realm..."/>	
<i>No authentication realms have been defined.</i>	
Global Settings	
Transparent Authentication Type:	Cookie
Authentication Timeout:	300 seconds
Action if Authentication Service Unavailable:	Block all traffic if authentication fails
Authentication Cache (Basic Only):	Cache TTL: 3600 seconds Cache Size: 8192 entries
<input type="button" value="Edit Global Settings..."/>	

When you create two or more realms, you can order them in an authentication sequence. For more information, see “Working with Authentication Sequences” on page 366.

Creating Authentication Realms

When you first create a realm, you choose the protocol type, either LDAP or NTLM. After you create an NTLM realm, the appliance only allows you to create LDAP realms. After you enter the authentication settings, you can verify that the parameters you entered are valid before you submit your changes. For more information about testing the authentication settings, see “Testing Authentication Settings” on page 370.

To create an authentication realm:

1. On the Network > Authentication page, click **Add Realm**. The Add Realm page appears.
2. Enter a name for the authentication realm in the Realm Name field.
Note — All sequence and realm names must be unique. Also, the name must not contain the percent (%) character.
3. If no NTLM realm is defined, choose the authentication protocol and scheme in the Authentication Protocol and Scheme(s) field.
4. Enter the authentication settings as necessary, depending on the protocol type.
 - For details on LDAP settings, see Table 17-12 on page 390.
 - For details on NTLM settings, see Table 17-15 on page 397.
5. You can test the parameters you entered by clicking **Start Test** in the Test Current Settings section.
6. Submit and commit your changes.

Editing Authentication Realms

To edit an authentication realm:

1. On the Network > Authentication page, click the realm name.
2. Change the name of the realm if necessary.
3. Edit the authentication settings as necessary, depending on the protocol type.
 - For details on LDAP settings, see Table 17-12 on page 390.
 - For details on NTLM settings, see Table 17-15 on page 397.
4. You can test the parameters you entered by clicking **Start Test** in the Test Current Settings section.
5. Submit and commit your changes.

Deleting Authentication Realms

When you delete a realm, the Web Security appliance automatically deletes that realm from any sequence that used it. Also, any Identity policy group that depends on the deleted realm becomes disabled.

To delete an authentication realm:

1. On the Network > Authentication page, click the trash can icon for the realm name.
2. Confirm that you want to delete the realm by clicking **Delete**.
3. Commit your changes.

WORKING WITH AUTHENTICATION SEQUENCES

When you create more than one realm, you can group the realms into an authentication sequence. An authentication sequence is a group of authentication realms listed in the order the Web Security appliance uses for authenticating clients.

You can perform any of the following tasks when configuring authentication sequences:

- Create multiple authentication sequences.
- Include one or more realms in an authentication sequence.
- Include realms of different protocols in a single authentication sequence.
- Assign a realm or a sequence to an Access Policy group.

You create authentication sequences on the Network > Authentication page under the Realm Sequences section. The Realm Sequences section only appears when you create two or more realms. Figure 17-3 shows where you create, edit, and delete authentication sequences. Figure 17-3.

Figure 17-3 Authentication Page — Authentication Sequences

Authentication

Authentication Realms					
Add Realm...					
Realm Name	Protocol	Scheme(s)	Servers	Base DN or NetBIOS Domain	Delete
ad2	NTLM	NTLMSSP or Basic	ad2.wga	WGA	
ldap1	LDAP	Basic	sunone.qa:389	ou=raptor,dc=qa	

Realm Sequences		
Add Sequence...		
Realm Sequence Name	Order of Realms	Delete
ldap_and_ad	NTLMSSP: ad2 Basic: ldap1, ad2	
All Realms	NTLMSSP: ad2 Basic: ad2, ldap1	

Click sequence name to edit. All Realms default authentication sequence. Delete authentication sequence.

Create authentication sequence.

After you create the second realm, the appliance automatically displays the Realm Sequences section and includes a default authentication sequence named All Realms. The All Realms sequence automatically includes each realm you define. You can change the order of the realms within the All Realms sequence, but you cannot delete any of its realms. You cannot delete the All Realms sequence.

Creating Authentication Sequences

You can create an authentication sequence after you create multiple authentication realms.

To create an authentication sequence:

1. On the Network > Authentication page, click **Add Sequence**.

The Add Realm Sequence page appears.

Add Realm Sequence

Choose realm.

Add a realm to the sequence.

Delete the realm.

2. Enter a name for the sequence in the Name for Realm Sequence field.

Note — All sequence and realm names must be unique.

3. In the first row of the Authentication Realm Sequence area, choose the realm name you want to include in the sequence from the Realms field.
4. If you want to include more realms, click **Add Row**.
5. Choose the realm name for any additional row you add.

Note — You can delete a realm from the sequence by clicking the trash can icon for that row.

6. When you have entered all realms in the sequence, and they are in the order you want, submit and commit your changes.

Editing Authentication Sequences

To edit an authentication sequence:

1. On the Network > Authentication page, click the sequence name.
2. Perform any of the following tasks as necessary:
 - Change the name of the sequence.
 - Add a new realm by clicking **Add Row**.

- Delete a realm by clicking the trash can icon.
 - Change the order of the realms by clicking the arrow icon in the Order column for the realm.
3. Submit and commit your changes.

Deleting Authentication Sequences

If you delete an authentication sequence, any Access Policy group that depends on the deleted sequence becomes disabled.

To delete an authentication sequence:

1. On the Network > Authentication page, click the trash can icon for the sequence name.
2. Confirm that you want to delete the sequence by clicking **Delete**.
3. Commit your changes.

APPLIANCE BEHAVIOR WITH MULTIPLE AUTHENTICATION REALMS

You can configure the Web Security appliance to attempt authenticating clients against multiple authentication servers, and against authentication servers with different authentication protocols. When you configure the appliance to authenticate against multiple authentication servers, it only requests the credentials from the clients once. This is true even when you configure the appliance to authenticate against different protocols.

You might want to configure a web policy group to authenticate against different realms if your organization acquires another organization that has its own authentication server using the same or a different authentication protocol. That way, you can create one Access Policy group for all users and assign to the policy group an authentication sequence that contains a realm for each authentication server.

When you assign an authentication sequence with multiple realms to a policy group and a client sends a content request, the appliance performs the following actions:

1. The appliance gets the credentials from the client.
2. The appliance attempts to authenticate the client against the authentication server(s) defined in the first realm in the sequence.
3. If the client credentials do not match a user in the servers defined in the first realm, it tries to authenticate against the authentication server(s) in the next realm in the sequence.
4. The appliance continues trying to authenticate the client against servers in the next realms until it either succeeds or runs out of authentication realms.
5. When authentication succeeds, the appliance passes the content response to the client.
6. When the appliance fails to authenticate the client against any authentication realm in the sequence, the appliance does not allow the client to connect to the destination server. Instead, it displays an error message to the client.

Tip: For optimal performance, configure clients on a subnet to be authenticated in a single realm.

TESTING AUTHENTICATION SETTINGS

When you create or edit an authentication realm, you enter a lot of configuration settings to connect to the authentication server. You can test the settings you enter before submitting the changes to verify you entered the connection information correctly.

You can test authentication setting from either the CLI or the web interface:

- **Web interface.** Use **Start Test** when you create or edit an authentication realm. For more information, see “Testing Authentication Settings in the Web Interface” on page 371.
- **CLI command.** Use the `testauthconfig` command. For more information, see “Testing Authentication Settings in the CLI” on page 372.

Testing Process

When you test authentication settings, the Web Security appliance first verifies that the settings you entered for the realm are in valid formats. For example, if a field requires a string and it currently contains a numeric value, the appliance informs you of that error.

If all fields contain valid values, the appliance performs different steps, depending on the authentication protocol. If the realm contains multiple authentication servers, the appliance goes through the testing process for each server in turn.

The appliance continues testing all servers in the realm and determines as many failures as possible for each server. It reports the testing outcome of each server in the realm.

LDAP Testing

The appliance performs the following steps when you test LDAP authentication settings:

1. It ensures that the LDAP server is listening on the specified LDAP port.
2. If Secure LDAP is selected, the appliance ensures the LDAP server supports secure LDAP.
3. It performs an LDAP query using the supplied Base DN, User Name Attribute, and User Filter Query.
4. If the realm includes Bind Parameters, the appliance validates them by forming an LDAP query with the Bind Parameters.
5. If Group Authorization is provided, the appliance ensures that the specified group attributes are valid by fetching the groups from the server.

NTLM Testing

The appliance performs the following steps when you test NTLM authentication settings:

1. It ensures that the specified Active Directory server is reachable and responds to queries.
2. It ensures that a DNS lookup on the Active Directory domain is successful since it must be a DNS domain name and not a WINS domain name.
3. It ensures the system time of the appliance and the system time of the Active Directory server are within three minutes of each other.

4. It validates the user credentials by generating a kerberos ticket.
5. It validates whether the user has the proper privileges to add the Web Security appliance to the Active Directory domain.
6. It validates whether you can fetch the groups within the domain.

Testing Authentication Settings in the Web Interface

You verify the authentication settings in the Test Current Settings section when you create or edit an authentication realm.

Figure 17-4 shows where you verify the authentication settings in the web interface.

Figure 17-4 Network > Authentication Page — Test Current Settings Section

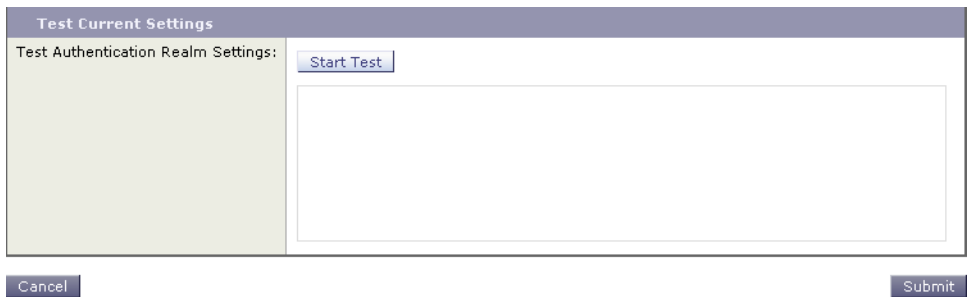

After you enter all settings, click **Start Test**. The appliance uses the connection information entered to attempt to connect to the authentication server. It displays the status of the test below **Start Test**.

Start Test changes to **Stop Test** while the appliance tests the settings against the authentication servers. If the testing takes too much time and you already know it is going to fail, you can click **Stop Test** to stop the testing process and edit the settings.

Figure 17-5 shows the testing results for an LDAP authentication realm.

Figure 17-5 Authentication Testing Results

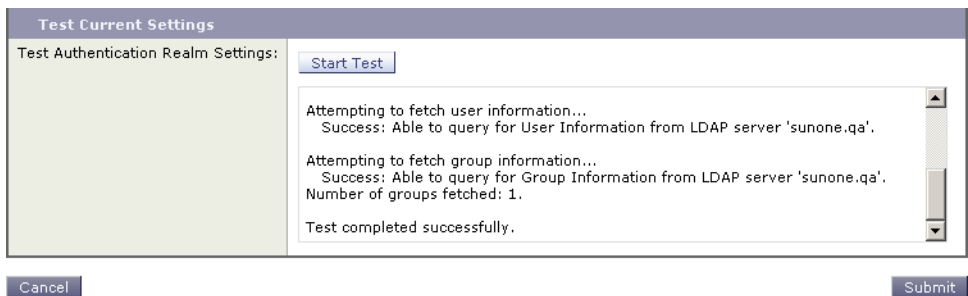

Testing Authentication Settings in the CLI

You can use the `testauthconfig` CLI command to test authentication settings defined for a given realm. The command syntax is:

```
testauthconfig [-d level] [realm name]
```

Running the command without any option causes the appliance to list the configured authentication realms from which you can make a selection.

The debug flag (`-d`) controls the level of debug information. The levels can range between 0-10. If unspecified, the appliance uses a level of 0. With level 0, the command will return success or failure. If the test settings fail, the command will list the cause of the failure.

Note — IronPort recommends you use level 0. Only use a different debug level when you need more detailed information to troubleshoot.

For more information about the `testauthconfig` command, see “Web Security Appliance CLI Commands” on page 554.

CONFIGURING GLOBAL AUTHENTICATION SETTINGS

Some authentication settings are independent of any realm you define. For example, you can configure whether or not clients send authentication credentials to the Web Security appliance securely, even when using Basic authentication scheme. For more information, see “Sending Authentication Credentials Securely” on page 383.

Figure 17-6 shows the global authentication settings on the Network > Authentication page.

Figure 17-6 Network > Authentication Page

Authentication

Authentication Realms	
<input type="button" value="Add Realm..."/>	
<i>No authentication realms have been defined.</i>	
Global Authentication Settings	
Action if Authentication Service Unavailable:	Block all traffic if authentication fails
Failed Authentication Handling:	Log Guest User by: IP Address
Re-authentication:	Disabled
Basic Authentication Token TTL:	3600
Transparent Proxy Mode Authentication Settings	
Credential Encryption:	Disabled
Redirect Hostname:	wsa01-vmw1-tpub.ga
Credential Cache Options:	Surrogate Type: Session Cookie Surrogate Timeout: 3600 seconds Cache Size: 8192 entries
Exception for Explicit Forward Requests:	Enabled
<input type="button" value="Edit Global Settings..."/>	

Note — The global authentication settings you can configure changes according to the Web Proxy deployment. You can configure more settings when it is deployed in transparent mode than in explicit forward mode.

To configure global authentication settings:

1. On the Network > Authentication page, click **Edit Global Settings**.

The Edit Global Authentication Settings page appears with two main sections, one labeled Global Authentication Settings and the other labeled for the proxy deployment type, either transparent or forward.

Figure 17-7 on page 374 shows the Global Authentication Settings section.

Figure 17-7 Global Authentication Settings

Edit Global Authentication Settings

Global Authentication Settings	
Action if Authentication Service Unavailable:	<input type="radio"/> Permit traffic to proceed without authentication <input checked="" type="radio"/> Block all traffic if authentication fails
Failed Authentication Handling:	Log Guest User by: <input checked="" type="radio"/> IP Address <input type="radio"/> User Name as Entered by End-User
Re-authentication:	<input type="checkbox"/> Enable Re-Authentication Prompt If End User Blocked by URL Category
Basic Authentication Token TTL: (?)	<input type="text" value="3600"/> seconds

2. Edit the settings in the Global Authentication Settings section as defined in Table 17-8.

Table 17-8 Global Authentication Settings

Setting	Description
Action if Authentication Service Unavailable	Choose one of the following values: <ul style="list-style-type: none"> • Permit traffic to proceed without authentication. Processing continues as if the user was authenticated. • Block all traffic if user authentication fails. Processing is discontinued and all traffic is blocked.
Failed Authentication Handling	When you grant users guest access in an Identity policy, this setting determines how the Web Proxy identifies and logs the user as a guest in the access logs. For more information on granting users guest access, see “Allowing Guest Access to Users Who Fail Authentication” on page 155.
Re-authentication (Enable Re-Authentication Prompt If End User Blocked by URL Category)	This setting allows users to authenticate again if the user is blocked from a website due to a restrictive URL filtering policy. The user sees a block page that includes a link that allows them to enter new authentication credentials. If the user enters credentials that allow greater access, the requested page appears in the browser. Note: This setting only applies to authenticated users who are blocked due to restrictive URL filtering policies. It does not apply to blocked transactions by subnet with no authentication. For more information, see “Allowing Users to Re-Authenticate” on page 386.

Table 17-8 Global Authentication Settings (Continued)

Setting	Description
Basic Authentication Token TTL	Controls the length of time that user credentials are stored in the cache before revalidating them with the authentication server. The default value is the recommended setting. When the Surrogate Timeout setting is configured and is greater than the Basic Authentication Token TTL, then the Surrogate Timeout value takes precedence and the Web Proxy contacts the authentication server after surrogate timeout expires.

The remaining authentication settings you can configure depends on how the Web Proxy is deployed, in transparent or explicit forward mode.

Figure 17-8 on page 375 shows where you configure the global authentication settings when the Web Proxy is deployed in transparent mode.

Figure 17-8 Transparent Proxy Mode Authentication Settings

Transparent Proxy Mode Authentication Settings

Credential Encryption: Use encrypted HTTPS connection for authentication

HTTPS Redirect Port:

Redirect Hostname: To achieve true single sign-on for Internet Explorer, use the short hostname or NetBIOS name instead of the fully qualified domain name.

Credential Cache Options:

Surrogate Type: IP Address
 Persistent Cookie
 Session Cookie

Surrogate Timeout: seconds
 Cache Size: number of entries

Explicit Forward Requests: If this option is not selected, no surrogates will be used with explicit forward requests and NTLM credential caching will not be available to these requests.

Advanced

Common name: IronPort Appliance Demo Certificate
 Organization: IronPort Systems, Inc.
 Organizational Unit:
 Country: US
 Expiration Date: May 1 22:57:58 2016 GMT
 Basic Constraints: Not Critical

Certificate:

Key:
Private key must be unencrypted.

Uploading a new pair of certificate and key will replace the currently used certificate and key as displayed above.

3. If the Web Proxy is deployed in transparent mode, edit the settings in Table 17-9.

Table 17-9 Transparent Proxy Mode Authentication Settings

Setting	Description
Credential Encryption	<p>This setting specifies whether or not the client sends the login credentials to the Web Proxy through an encrypted HTTPS connection.</p> <p>This setting applies to both Basic and NTLMSSP authentication schemes, but it is particularly useful for Basic authentication scheme because user credentials are sent as plain text.</p> <p>For more information, see “Sending Authentication Credentials Securely” on page 383.</p> <p>When you enable credential encryption using this setting, you must also specify a TCP port in the HTTPS Redirect Port field. This specifies through which port the client will open a connection to the Web Proxy using HTTPS.</p>

Table 17-9 Transparent Proxy Mode Authentication Settings (Continued)

Setting	Description
Redirect Hostname	<p>Enter the short host name of the network interface on which the Web Proxy listens for incoming connections.</p> <p>When you configure authentication on an appliance deployed in transparent mode, the Web Proxy uses this host name in the redirection URL sent to clients for authenticating users.</p> <p>You can enter either the following values:</p> <ul style="list-style-type: none"> <p>Single word host name. You can enter the single word host name that is DNS resolvable by the client and the Web Security appliance. This allows clients to achieve true single sign-on with Internet Explorer without additional browser side setup.</p> <p>Be sure to enter the single word host name that is DNS resolvable by the client and the Web Security appliance. For example, if your clients are in domain <code>mycompany.com</code> and the interface on which the Web Proxy is listening has a full host name of <code>proxy.mycompany.com</code>, then you should enter <code>proxy</code> in this field. Clients perform a lookup on <code>proxy</code> and they should be able to resolve <code>proxy.mycompany.com</code>.</p> <p>Fully qualified domain name (FQDN). You can also enter the FQDN or IP address in this field. However, if you do that and want true single sign-on for Internet Explorer and Firefox browsers, you must ensure that the FQDN or IP address is added to the client's Trusted Sites list in the client browsers.</p> <p>The default value is the FQDN of the M1 or P1 interface, depending on which interface is used for proxy traffic.</p>

Table 17-9 Transparent Proxy Mode Authentication Settings (Continued)

Setting	Description
<p>Credential Cache Options: Surrogate Type</p>	<p>This setting specifies the way that transactions are associated with a user (either by IP address or using a cookie) after the user has authenticated successfully.</p> <p>Choose one of the following options:</p> <ul style="list-style-type: none"> • IP Address. The appliance authenticates the user at a particular IP address. You can achieve single sign-on behavior when you choose IP-based authentication. • Persistent Cookie. The appliance authenticates a user on a particular application by generating a persistent cookie for each user per application. The cookie is not removed when the application is closed. • Session Cookie. The appliance authenticates a user on a particular application by generating a session cookie for each user per domain per application. (However, when a user provides different credentials for the same domain from the same application, the cookie is overwritten.) The cookie is removed when the application is closed. <p>You might want to use IP-based authentication when there is only one user on a client machine and you want users to be able to achieve single sign-on behavior.</p> <p>You might want to choose cookie-based authentication when there are multiple users on one machine, such as a Citrix server.</p> <p>For more information about which authentication surrogates are supported with other configurations and different types of requests, see “Tracking Authenticated Users” on page 389.</p>
<p>Credential Cache Options: Surrogate Timeout</p>	<p>This setting specifies how long the Web Proxy waits before asking the client for authentication credentials again. Until the Web Proxy asks for credentials again, it uses the value stored in the surrogate (IP address or cookie).</p> <p>It is common for user agents, such as browsers, to cache the authentication credentials so the user will not be prompted to enter credentials each time.</p>
<p>Credential Cache Options: Cache Size</p>	<p>Specifies the number of entries that are stored in the authentication cache. Set this value to safely accommodate the number of users that are actually using this device. The default value is the recommended setting.</p>
<p>Explicit Forward Requests</p>	<p>This setting specifies whether the surrogate used for transparent requests should also be used for explicit requests.</p>

Table 17-9 Transparent Proxy Mode Authentication Settings (Continued)

Setting	Description
Advanced (Secure Authentication Certificate)	<p>When Credential Encryption is enabled, you can choose whether the appliance uses the digital certificate and key shipped with the appliance or a digital certificate and key you upload here.</p> <p>To upload a digital certificate and key, click Browse and navigate to the necessary file on your local machine. Then click Upload Files after you select the files you want.</p> <p>For more information, see “Uploading Certificates and Keys to Use with Credential Encryption” on page 384.</p>

Figure 17-9 on page 379 shows where you configure the global authentication settings when the Web Proxy is deployed in explicit forward mode.

Figure 17-9 Explicit Forward Proxy Mode Authentication Settings

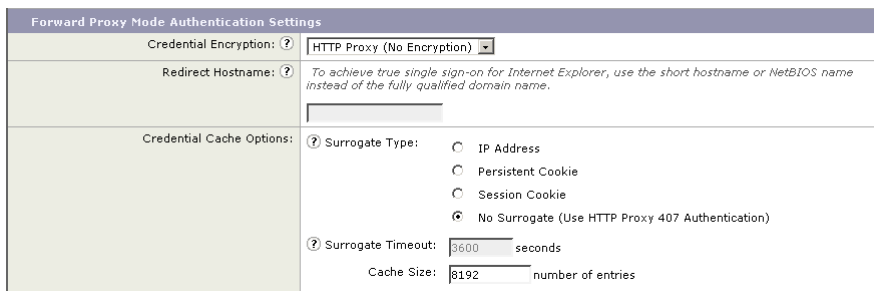

Forward Proxy Mode Authentication Settings

Credential Encryption:

Redirect Hostname: *To achieve true single sign-on for Internet Explorer, use the short hostname or NetBIOS name instead of the fully qualified domain name.*

Credential Cache Options:

Surrogate Type:

- IP Address
- Persistent Cookie
- Session Cookie
- No Surrogate (Use HTTP Proxy 407 Authentication)

Surrogate Timeout: seconds

Cache Size: number of entries

4. If the Web Proxy is deployed in explicit forward mode, edit the settings in Table 17-10.

Table 17-10 Explicit Forward Proxy Mode Authentication Settings

Setting	Description
Credential Encryption	<p>This setting specifies whether or not the client sends the login credentials to the Web Proxy through an encrypted HTTPS connection. To enable credential encryption, choose “HTTPS Redirect (Secure)”. When you enable credential encryption, additional fields appear to configure how to redirect clients to the Web Proxy for authentication.</p> <p>This setting applies to both Basic and NTLMSSP authentication schemes, but it is particularly useful for Basic authentication scheme because user credentials are sent as plain text.</p> <p>For more information, see “Sending Authentication Credentials Securely” on page 383.</p>
HTTPS Redirect Port	<p>When you enable credential encryption, specify a TCP port to use for redirecting requests. This specifies through which port the client will open a connection to the Web Proxy using HTTPS.</p>

Table 17-10 Explicit Forward Proxy Mode Authentication Settings (Continued)

Setting	Description
Redirect Hostname	<p>Enter the short host name of the network interface on which the Web Proxy listens for incoming connections.</p> <p>When you enable Authentication Mode above, the Web Proxy uses this host name in the redirection URL sent to clients for authenticating users.</p> <p>You can enter either the following values:</p> <ul style="list-style-type: none"> <p>Single word host name. You can enter the single word host name that is DNS resolvable by the client and the Web Security appliance. This allows clients to achieve true single sign-on with Internet Explorer without additional browser side setup.</p> <p>Be sure to enter the single word host name that is DNS resolvable by the client and the Web Security appliance. For example, if your clients are in domain <code>mycompany.com</code> and the interface on which the Web Proxy is listening has a full host name of <code>proxy.mycompany.com</code>, then you should enter <code>proxy</code> in this field. Clients perform a lookup on <code>proxy</code> and they should be able to resolve <code>proxy.mycompany.com</code>.</p> <p>Fully qualified domain name (FQDN). You can also enter the FQDN or IP address in this field. However, if you do that and want true single sign-on for Internet Explorer and Firefox browsers, you must ensure that the FQDN or IP address is added to the client's Trusted Sites list in the client browsers.</p> <p>The default value is the FQDN of the M1 or P1 interface, depending on which interface is used for proxy traffic.</p>

Table 17-10 Explicit Forward Proxy Mode Authentication Settings (Continued)

Setting	Description
<p>Credential Cache Options: Surrogate Type</p>	<p>This setting specifies the way that transactions used for authenticating the client are associated with a user (either by IP address or using a cookie) after the user has authenticated successfully.</p> <p>Choose one of the following options:</p> <ul style="list-style-type: none"> • IP Address. The Web Proxy authenticates the user at a particular IP address. You can achieve single sign-on behavior when you choose IP-based authentication. • Persistent Cookie. The Web Proxy authenticates a user on a particular application by generating a persistent cookie for each user per application. The cookie is not removed when the application is closed. • Session Cookie. The Web Proxy authenticates a user on a particular application by generating a session cookie for each user per application. The cookie is removed when the application is closed. • No Surrogate. The Web Proxy does not use any surrogate to cache the credentials, and it authenticates the user for every new TCP connection. When you select this option, the web interface disables other settings that no longer apply. This option is available only when you disable credential encryption. <p>You might want to use IP-based authentication when there is only one user on a client machine and you want users to be able to achieve single sign-on behavior.</p> <p>You might want to choose cookie-based authentication when there are multiple users on one machine, such as a Citrix server.</p> <p>For more information about which authentication surrogates are supported with other configurations and different types of requests, see “Tracking Authenticated Users” on page 389.</p>
<p>Credential Cache Options: Surrogate Timeout</p>	<p>This setting specifies how long the Web Proxy waits before asking the client for authentication credentials again. Until the Web Proxy asks for credentials again, it uses the value stored in the surrogate (IP address or cookie).</p> <p>Note that it is common for user agents, such as browsers, to cache the authentication credentials so the user will not be prompted to enter credentials each time.</p>

Table 17-10 Explicit Forward Proxy Mode Authentication Settings (Continued)

Setting	Description
Credential Cache Options: Cache Size	Specifies the number of entries that are stored in the authentication cache. Set this value to safely accommodate the number of users that are actually using this device. The default value is the recommended setting.
Advanced (Secure Authentication Certificate)	<p>When Credential Encryption is enabled to use a secure connection using HTTPS, you can choose whether the appliance uses the digital certificate and key shipped with the appliance or a digital certificate and key you upload here.</p> <p>To upload a digital certificate and key, click Browse and navigate to the necessary file on your local machine. Then click Upload Files after you select the files you want.</p> <p>For more information, see “Uploading Certificates and Keys to Use with Credential Encryption” on page 384.</p>

5. Submit and commit your changes.

Sending Authentication Credentials Securely

When authentication is used to identify clients using the Web, the client applications send the authentication credentials to the Web Proxy, which in turn passes them to the authentication server. How the credentials are passed from the clients to the Web Proxy depends on the authentication scheme used:

- **NTLMSSP.** The credentials are always passed to the Web Proxy securely. They are encrypted using a key specified by the Active Directory server and sent over HTTP.
- **Basic.** By default, the credentials are passed to the Web Proxy insecurely. They are encoded, but not encrypted, and sent over HTTP. However, you can configure the Web Security appliance so clients send authentication credentials securely. This works for both LDAP and NTLM Basic authentication.

When you configure the appliance to use credential encryption for Basic authentication, the Web Proxy redirects the client back to the Web Proxy, but this time using an encrypted connection using HTTPS. The client application makes either a GET or a CONNECT request depending on how the requests are forwarded to the appliance (explicitly or transparently) and how the client application is configured to forward HTTPS requests, either using the Web Proxy or not.

Then, using the secure HTTPS connection, the clients send the authentication credentials. The appliance uses its own certificate and private key to create an HTTPS connection with the client by default. Most browsers will warn users that the certificate is not valid. To prevent users from seeing the invalid certificate message, you can upload a certificate and key pair your organization uses. When you upload a certificate and key, the private key must be

unencrypted. For information about uploading a certificate and key, see “Uploading Certificates and Keys to Use with Credential Encryption” on page 384.

To configure the appliance to use credential encryption, enable the Credential Encryption setting in the global authentication settings. For more information, see “Configuring Global Authentication Settings” on page 373. You can also use the `advancedproxyconfig > authentication` CLI command. For more information, see “Advanced Proxy Configuration” on page 108.

Uploading Certificates and Keys to Use with Credential Encryption

When credential encryption is enabled, the appliance uses a digital certificate to securely establish a connection with the client application. By default, the Web Security appliance uses the “IronPort Appliance Demo Certificate” that comes installed. However, client applications are not programmed to recognize this certificate, so you can upload a digital certificate to the appliance that your applications recognize automatically.

Use the Advanced section on the Network > Authentication page to upload the certificate and key.

Note — When AsyncOS for Web runs on a FIPS-compliant Web Security appliance, you must use the FIPS management console to generate or upload the root certificate and key pair. When you generate or upload certificates and keys using the FIPS management console, the keys are protected by the HSM card. For more information on using the FIPS management console, see “FIPS Management” on page 67.

For more information on obtaining a certificate and private key pair to upload, see “Obtaining Certificates” on page 534.

Note — Any certificate and key you upload on the Network > Authentication page is only used for establishing secure connections with clients for credential encryption. The certificate and key are not used for establishing secure HTTPS sessions when connecting to the Web Security appliance web interface. For more information on uploading a certificate and key pair for HTTPS connections to the web interface, see “Installing a Server Digital Certificate” on page 534.

Accessing HTTPS and FTP Sites with Credential Encryption Enabled

Credential encryption works because the Web Proxy redirects clients to the Web Proxy itself for authentication using an HTTPS connection. After successful authentication, the Web Proxy redirects clients back to original web site. In order to continue to identify the user, the Web Proxy must use a surrogate (either the IP address or a cookie).

However, using a cookie to track users when the client accesses HTTPS sites or FTP servers using FTP over HTTP does not work.

- **HTTPS.** The Web Proxy must resolve the user identity before assigning a Decryption Policy (and therefore, decrypt the transaction), but it cannot obtain the cookie to identify the user unless it decrypts the transaction.

- **FTP over HTTP.** The dilemma with accessing FTP servers using FTP over HTTP is similar to accessing HTTPS sites. The Web Proxy must resolve the user identity before assigning an Access Policy, but it cannot set the cookie from the FTP transaction.

Because of this, you should configure the appliance to use IP addresses as the surrogate when credential encryption is enabled.

Note — Authentication does not work with HTTPS and FTP over HTTP requests when credential encryption is enabled and configured to use cookies as the surrogate type. Therefore, with this configuration setup, HTTPS and FTP over HTTP requests only match Access Policies that do not require authentication. Typically, they often match the global Access Policy since it never requires authentication.

ALLOWING USERS TO RE-AUTHENTICATE

AsyncOS for Web can block users from accessing different categories of websites depending on who is trying to access a website. In these cases, users successfully authenticate, but they are not authorized to access certain websites due to configured URL filtering in the applicable Access Policy. You can allow these authenticated users another opportunity to access the web if they fail authorization.

Note — Only authenticated users are allowed to re-authenticate, not unauthenticated users.

You might want to do this for shared workstations that have multiple users, but the default account has limited access. If the default account on the workstation is blocked from a website due to restrictive URL filtering, the user can enter different authentication credentials that allow broader, more privileged access.

To do this, enable the “Enable Re-Authentication Prompt If End User Blocked by URL Category” global authentication setting. The user sees a block page that includes a link that allows them to enter new authentication credentials. The Web Proxy evaluates those credentials against the authentication realms defined in the applicable Identity group, and if the new credentials allow greater access, the requested page appears in the browser. For more information, see “Configuring Global Authentication Settings” on page 373.

Note — The Web Proxy evaluates the new credentials against the authentication realms defined in the applicable Identity group only. It does not compare them against all other Identity groups.

When a more privileged user authenticates and gets access, the Web Proxy caches the privileged user identity for different amounts of time depending on the authentication surrogates configured:

- **Session cookie.** The privileged user identity is used until the browser is closed or the session times out.
- **Persistent cookie.** The privileged user identity is used until the surrogate times out.
- **IP address.** The privileged user identity is used until the surrogate times out.
- **No surrogate.** The Web Proxy requests authentication for every new connection, but most browsers will cache the privileged user credentials and authenticate without prompting the user until the browser is closed. However, because the Web Proxy requests authentication for every new connection, there is an increased impact on the authentication server when using NTLMSSP.

Note — To use the re-authentication feature with user defined end-user notification pages, the CGI script that parses the redirect URL must parse and use the Reauth_URL parameter. For more information, see “Working with User Defined End-User Notification Pages” on page 269.

Using Re-Authentication with Internet Explorer

When you enable re-authentication and clients use Microsoft Internet Explorer, you need to verify certain settings to ensure re-authentication works properly with Internet Explorer. Due to a known issue with Internet Explorer, re-authentication does not work properly under the following circumstances:

- Internet Explorer is configured to use the Web Security appliance as a proxy.
- The Web Security appliance uses NTLMSSP authentication.
- The Web Security appliance uses cookies for authentication surrogates, but is not configured for credential encryption.
- The Web Proxy is deployed in explicit forward mode, or it is deployed in transparent mode and the “Apply same surrogate settings to explicit forward requests” option on the Network > Authentication page is enabled.

Problems occur when authentication is required to access the site, and may occur either when initially requesting the site or when re-authenticating to try to access the site.

To work around these problems, enable credential encryption on the Network > Authentication page.

Using Re-Authentication with PAC Files

When you enable re-authentication and configure client applications to use a PAC file, you may need to verify certain settings to ensure re-authentication works properly with the PAC file.

Re-authentication does not work properly under the following circumstances:

- Client browsers are configured to use a PAC file, and the PAC file is designed to bypass the Web Proxy for internal web servers. Instead of instructing the browser to explicitly send requests to the Web Proxy, it instructs the browser to directly send the request to the destination server.
- The Web Security appliance uses IP addresses for authentication surrogates or no surrogates, and credential encryption is not enabled.
- The Web Proxy is deployed in explicit forward mode, or it is deployed in transparent mode and the “Apply same surrogate settings to explicit forward requests” option on the Network > Authentication page is enabled.

Problems occur because re-authentication requires clients to be redirected to the Web Proxy for authentication, but the PAC file bypasses all requests to internal web servers, including the Web Security appliance.

To work around these problems, edit the PAC file so that the function FindProxyForURL() returns “PROXY x.x.x.x:80” when the host IP address is x.x.x.x. The port number you specify in the return should be the same port configured for other destinations.

Note — If the Web Security appliance uses cookies for authentication surrogates, IronPort recommends enabling credential encryption. For more information, see “Using Re-Authentication with Internet Explorer” on page 387.

TRACKING AUTHENTICATED USERS

Table 17-11 describes which authentication surrogates are supported with other configurations and different types of requests (explicitly forwarded and transparently redirected).

Table 17-11 Supported Authentication Surrogates

Surrogate Types	Explicit Requests				Transparent Requests			
	Disabled		Enabled		Disabled		Enabled	
Credential Encryption:								
Protocol:	HTTP	HTTPS & FTP over HTTP	HTTP	HTTPS & FTP over HTTP	HTTP	HTTPS	HTTP	HTTPS
No Surrogate	Yes	Yes	NA	NA	NA	NA	NA	NA
IP-based	Yes	Yes	Yes	Yes	Yes	No/Yes*	Yes	No/Yes*
Cookie-based	Yes	Yes***	Yes	No/Yes**	Yes	No/Yes**	Yes	No/Yes**

* Works after the client makes a request to an HTTP site and is authenticated. All requests to HTTPS sites before this happens are dropped citing authentication failure.

** When cookie-based authentication is used, the Web Proxy cannot authenticate the user for HTTPS and FTP over HTTP transactions. Due to this limitation, all HTTPS and FTP over HTTP requests bypass authentication, so authentication is not requested at all. For more information on how HTTPS requests are assigned Identity and non-Identity policy groups, see “How Authentication Affects HTTPS and FTP over HTTP Requests” on page 149.

*** No surrogate is used in this case even though cookie-based surrogate is configured.

LDAP AUTHENTICATION

The Lightweight Directory Access Protocol (LDAP) server database is a repository for employee directories. These directories include the names of employees along with various types of personal data such as a phone number, email address, and other information that is exclusive to the individual employee. The LDAP database is composed of objects containing attributes and values. Each object name is referred to as a distinguished name (DN). The location on the LDAP server where a search begins is called the Base Distinguished Name or base DN.

The appliance supports standard LDAP server authentication and Secure LDAP authentication. Support for LDAP allows established installations to continue using their LDAP server database to authenticate users.

For Secure LDAP, the appliance supports LDAP connections over SSL. The SSL protocol is an industry standard for ensuring confidentiality. SSL uses key encryption algorithms along with Certificate Authority (CA) signed certificates to provide the LDAP servers a way to verify the identity of the appliance.

Note — AsyncOS for Web only supports 7-bit ASCII characters for passwords when using the Basic authentication scheme. Basic authentication fails when the password contains characters that are not 7-bit ASCII.

Changing Active Directory Passwords

After Active Directory LDAP users change their account passwords, the Active Directory LDAP server authenticates them with their current or previous password, depending on the Active Directory server configuration.

If you want users to only be able to authenticate with their new password, you can reboot the Active Directory server or, you can wait for the Active Directory server to time out the old passwords.

LDAP Authentication Settings

Table 17-12 describes the authentication settings you define when you choose LDAP authentication.

Table 17-12 LDAP Authentication Settings

Setting	Description
LDAP Version	Choose the version of LDAP, and choose whether or not to use Secure LDAP. The appliance supports LDAP version 2, and LDAP version 3 software. Secure LDAP requires LDAP version 3.

Table 17-12 LDAP Authentication Settings (Continued)

Setting	Description
LDAP Server	<p>Enter the LDAP server IP address or host name and its port number. You can specify up to three servers.</p> <p>The host name must be a fully-qualified domain name. For example, <code>ldap.example.com</code>. An IP address is required only if the DNS servers configured on the appliance cannot resolve the LDAP server host name.</p> <p>The default port number for Standard LDAP is 389. The default number for Secure LDAP is 636.</p> <p>If the LDAP server is an Active Directory server, enter the host name or IP address and the port of the domain controller here. Whenever possible, enter the name of the Global Catalog Server and use port 3268. However, you might want to use a local domain controller when the global catalog server is physically far away and you know you only need to authenticate users on the local domain controller.</p> <p>Note: When you configure multiple authentication servers in the realm, the appliance attempts to authorize with up to three authentication servers before failing to authenticate the transaction within that realm.</p>
LDAP Persistent Connections (under the Advanced section)	<p>Choose one of the following values:</p> <ul style="list-style-type: none"> • Use persistent connections (unlimited). Use existing connections. If no connections are available a new connection is opened. • Use persistent connections. Use existing connections to service the number of requests specified. When the maximum is reached, establish a new connection to the LDAP server. • Do not use persistent connections. Always create a new connection to the LDAP server.

Table 17-12 LDAP Authentication Settings (Continued)

Setting	Description
User Authentication	<p>Enter values for the following fields:</p> <p>Base Distinguished Name (Base DN) The LDAP database is a tree-type directory structure and the appliance uses the Base DN to navigate to the correct location in the LDAP directory tree to begin a search. A valid Base DN filter string is composed of one or more components of the form <code>object-value</code>. For example <code>dc=companyname, dc=com</code>.</p> <p>User Name Attribute Choose one of the following values:</p> <ul style="list-style-type: none"> • uid, cn, and sAMAccountName. Unique identifiers in the LDAP directory that specify a username. • custom. A custom identifier such as <code>UserAccount</code>. <p>User Filter Query The User Filter Query is an LDAP search filter that locates the users Base DN. This is required if the user directory is in a hierarchy below the Base DN, or if the login name is not included in the user-specific component of that users Base DN.</p> <p>Choose one of the following values:</p> <ul style="list-style-type: none"> • none. Filters any user. • custom. Filters a particular group of users.
Query Credentials	<p>Choose whether or not the authentication server accepts anonymous queries.</p> <p>If the authentication server does accept anonymous queries, choose <code>Server Accepts Anonymous Queries</code>.</p> <p>If the authentication server does not accept anonymous queries, choose <code>Use Bind DN</code> and then enter the following information:</p> <ul style="list-style-type: none"> • Bind DN. The user on the external LDAP server permitted to search the LDAP directory. Typically, the bind DN should be permitted to search the entire directory. • Password. The password associated with the user you enter in the Bind DN field. <p>The following text lists some example users for the Bind DN field: <code>cn=administrator,cn=Users,dc=domain,dc=com</code> <code>sAMAccountName=jdoe,cn=Users,dc=domain,dc=com</code>.</p> <p>If the Active Directory server is used as an LDAP server, you may also enter the Bind DN username as "DOMAIN\username."</p>

Table 17-12 LDAP Authentication Settings (Continued)

Setting	Description
Group Authorization	Choose whether or not to enable LDAP group authorization. When you enable LDAP group authorization, you can group users by group object or user object. For more information on configuring this section, see “LDAP Group Authorization” on page 393.

LDAP Group Authorization

You can use the user group membership information stored in an LDAP directory to apply a policy group to a group of users. To do this, enable group authorization in an LDAP authentication realm and group users by one of the following LDAP object types:

- **Group object.** Sometimes, group membership information is stored in the group object, which has an attribute (such as “member”) to list all users that belong to the group. Define authorized users by group object when the group object contains all users you need to define. For more information on how to define authorized users by group object, see Table 17-13 on page 394.
- **User object.** Sometimes, group membership information is stored in the user object, which has an attribute (such as “memberOf”) that lists all groups to which a user belongs. You might want to define authorized users by user object when the authentication server does not store the member information in the group object or if it does not have a group object. For more information on how to define authorized users by user object, see Table 17-14 on page 394.

Note — The user object must not contain any special character.

When you configure group authorization in an LDAP authentication realm, be sure you uniquely identify a group object in the LDAP server. If the search for a group DN returns multiple entries, the Web Security appliance only uses the first entry returned. You uniquely identify a group object using the following fields:

- Base DN
- Attribute that contains the group name
- Query string to determine if object is a group

When you create an LDAP authentication realm with user object based group authorization against an Active Directory server, the user object does not contain the primary group that the user is a member of, for example “Domain Users.” It only contains the other defined groups. Therefore, policy groups might not match these users under the following conditions:

- An Identity policy group specifies an LDAP realm with user attribute based group authentication.

- A non-Identity policy group uses the Identity policy group and the primary group is configured as an authorized group in the Active Directory server.

Table 17-13 describes the group object settings.

Table 17-13 LDAP Group Authorization—Group Object Settings

Group Object Setting	Description
Group Membership Attribute Within Group Object	Choose the LDAP attribute which lists all users that belong to this group. Choose one of the following values: <ul style="list-style-type: none"> • member and uniquemember. Unique identifiers in the LDAP directory that specify group members. • custom. A custom identifier such as <code>UserInGroup</code>.
Attribute that Contains the Group Name	Choose the LDAP attribute which specifies the group name that can be used in the policy group configuration. Choose one of the following values: <ul style="list-style-type: none"> • cn. A unique identifier in the LDAP directory that specifies the name of a group. • custom. A custom identifier such as <code>FinanceGroup</code>.
Query String to Determine if Object is a Group	Choose an LDAP search filter that determines if an LDAP object represents a user group. Choose one of the following values: <ul style="list-style-type: none"> • objectclass=groupofnames • objectclass=groupofuniquenames • objectclass=group • custom. A custom filter such as <code>objectclass=person</code>. <p>Note: The query defines the set of authentication groups which can be used in policy groups.</p>

Table 17-14 describes the user object settings.

Table 17-14 LDAP Group Authorization—User Object Settings

User Object Setting	Description
Group Membership Attribute Within User Object	Choose the attribute which list all the groups that this user belongs to. Choose one of the following values: <ul style="list-style-type: none"> • memberOf. Unique identifiers in the LDAP directory that specify user members. • custom. A custom identifier such as <code>UserInGroup</code>.

Table 17-14 LDAP Group Authorization—User Object Settings (Continued)

User Object Setting	Description
Group Membership Attribute is a DN	Specify whether the group membership attribute is a distinguished name (DN) which refers to an LDAP object. For Active Directory servers, enable this option. When this is enabled, you must configure the subsequent settings.
Attribute that Contains the Group Name	When the group membership attribute is a DN, this specifies the attribute that can be used as group name in policy group configurations. Choose one of the following values: <ul style="list-style-type: none"> • cn. A unique identifier in the LDAP directory that specifies the name of a group. • custom. A custom identifier such as <code>FinanceGroup</code>.
Query String to Determine if Object is a Group	Choose an LDAP search filter that determines if an LDAP object represents a user group. Choose one of the following values: <ul style="list-style-type: none"> • objectclass=groupofnames • objectclass=groupofuniquenames • objectclass=group • custom. A custom filter such as <code>objectclass=person</code>. <p>Note: The query defines the set of authentication groups which can be used in Web Security Manager policies.</p>

NTLM AUTHENTICATION

The NT Lan Manager (NTLM) authenticates users with an encrypted challenge-response sequence that occurs between the appliance and a Microsoft Windows domain controller. The NTLM challenge-response handshake occurs when a web browser attempts to connect to the appliance and before data is delivered.

When you configure an NTLM authentication realm, you do not specify the authentication scheme. Instead, you choose the scheme at the Access Policy group level when you configure the policy member definition. This allows you to choose different schemes for different policy groups. When you create or edit the policy group, you can choose one of the following schemes:

- Use NTLMSSP
- Use Basic or NTLMSSP
- Use Basic

Note — AsyncOS for Web only supports 7-bit ASCII characters for passwords when using the Basic authentication scheme. Basic authentication fails when the password contains characters that are not 7-bit ASCII.

Working with Multiple Active Directory Domains

AsyncOS allows you to create only one NTLM authentication realm. If your organization has multiple Active Directory domains, you can authenticate users in all domains if the following conditions exist:

- All Active Directory domains must exist in a single forest.
- There must be a trust relationship among all domains in the forest.

When you define policy group membership by group name, the web interface only displays Active Directory groups in the domain where AsyncOS created a computer account when joining the domain. To create a policy group for users in a different domain in the forest, manually enter the domain and group name in the web interface.

NTLM Authentication Settings

Table 17-15 describes the authentication settings you define when you choose NTLM authentication.

Table 17-15 NTLM Authentication Settings

Setting	Description
Active Directory Server	<p>Enter the Active Directory server IP address or host name. You can specify up to three servers.</p> <p>The host name must be a fully-qualified domain name. For example, <code>ntlm.example.com</code>. An IP address is required only if the DNS servers configured on the appliance cannot resolve the Active Directory server host name.</p> <p>Note: When multiple authentication servers are configured in the realm, the appliance attempts to authorize with up to three authentication servers before failing to authorize the transaction within this realm.</p>
Active Directory Account	<p>Enter the following Active Directory account information:</p> <ul style="list-style-type: none"> • Active Directory server domain name. • NetBIOS domain name. You only need to enter the NetBIOS domain name if the network uses NetBIOS. This field only appears when the NTLM security mode is set to “domain” using the <code>setntlmsecuritymode</code> CLI command. • Computer account location. <p>Note: You must click Join Domain to enter an Active Directory username and password.</p> <p>For more information about entering the Active Directory account information, see “Joining the Active Directory Domain” on page 398.</p>
Join Domain button (Active Directory User)	<p>When you click Join Domain, enter the name and password for the Active Directory user.</p> <p>If the appliance and the Active Directory server are in the same domain, any valid user that is a member of User Domain is allowed.</p> <p>However, depending on the Active Directory server configuration, this user might need Domain Admin Group or Enterprise Admin Group credentials. For example:</p> <ul style="list-style-type: none"> • If the appliance and the Active Directory server are not in the same domain, the Active Directory user must be a member of the Domain Admin Group. • If the Active Directory server configuration is a forest, the Active Directory user must be a member of the Enterprise Admin Group.

Table 17-15 NTLM Authentication Settings (Continued)

Setting	Description
Network Security	Configure whether or not the Active Directory server is configured to require signing. When you enable this check box, the appliance uses Transport Layer Security (TLS) when communicating with the Active Directory server.

Joining the Active Directory Domain

When you configure an NTLM realm, you must enter information to join the Active Directory domain to set up a computer account in the domain. An Active Directory computer account is an account that uniquely identifies the computer on the domain. It is also referred to as a machine trust account.

After you enter the Active Directory account information in the authentication realm, click the **Join Domain** button to set up a computer account. Use the Location field to define the organizational directory where AsyncOS should create the computer account in the Active Directory domain.

Figure 17-10 on page 399 shows where you join an Active Directory domain.

Figure 17-10 Joining an Active Directory Domain

Add Realm

NTLM Authentication Realm	
Realm Name:	NTLM
Authentication Protocol and Scheme(s):	NTLM (NTLMSSP or Basic Authentication)
NTLM Authentication	
Active Directory Server:	Specify up to three Active Directory servers: example.wsa hostname or IP address
Active Directory Account:	Active Directory Domain: WSA Computer Account Location: Computers <i>(Example: Computers/BusinessUnit/Department/Servers)</i> Join Domain... Status: Computer account wsa01-vmw1-tpub\$ not yet created.
Network Security:	<input type="checkbox"/> Client Signing Required
Test Current Settings	
Test Authentication Realm Settings:	Start Test

Status tells you whether or not AsyncOS has created the computer account.

Click to join the Active Directory domain.

When you click **Join Domain**, you are prompted to enter login credentials for the Active Directory server. The login information is used only to create the Active Directory computer account and is not saved. Enter the login information and click **Create Account**.

Note — You must enter the sAMAccountName user name for the Active Directory user. Also, verify that users enter their sAMAccountName user name when they log in to their computers.

Once an account is created, the status of the account creation is displayed below the Join Domain button. If the account creation fails, the status and reason for error is displayed.

Also, when you view all realms on the Network > Authentication page, the appliance displays warning text in red saying that the domain was not joined for any realm that did not create a computer account.

Authentication

Success — The NTLM Realm "NTLM" was added.

Authentication Realms					
Add Realm...					
Realm Name	Protocol	Scheme(s)	Servers	Base DN or NetBIOS Domain	Delete
NTLM	NTLM	NTLMSSP or Basic	example.wsa	Domain not joined	

Red text indicates that the domain was not joined and no computer account was created.

AsyncOS only creates an Active Directory computer account when you edit the authentication realm Active Directory information or when the appliance reboots.

Note — To successfully join the Active Directory domain, the time difference between the Web Security appliance and the Active Directory server should be less than the time specified in the “Maximum tolerance for computer clock synchronization” option on the Active Directory server. When you use Network Time Protocol (NTP) to specify the current time on the Web Security appliance, remember that the default time server is time.ironport.com. This may affect the time difference between the appliance and the Active Directory server.

Some Active Directory environments automatically delete computer objects at particular intervals for accounts that appear in active in order to clean up old computer objects. However, AsyncOS does not automatically change the password for the computer account it creates in an Active Directory server, so the computer account may appear inactive over time. Therefore, if the Active Directory environment automatically deletes computer objects at particular intervals, make sure the Web Security appliance computer account is created in a container that is exempt from this cleanup process.

SUPPORTED AUTHENTICATION CHARACTERS

This section lists the characters the Web Security appliance supports when it communicates with LDAP and Active Directory servers. For authentication to work properly, verify that your authentication servers only use the supported characters listed in this section.

For example, according to Table 17-16, the appliance can validate users with the following Active Directory user name:

```
jsmith#123
```

And according to Table 17-16, the appliance cannot validate users with the following Active Directory user name:

```
jsmith+
```

Active Directory Server Supported Characters

Table 17-16 lists the characters the Web Security appliance supports for the User Name field for Active Directory servers.

Table 17-16 Supported Active Directory Server Characters — User Name Field

Supported Characters	Characters Not Supported
A...Z a...z 0 1 2 3 4 5 6 7 8 9 ` ~ ! # \$ % ^ & () _ - { } ' . space	/ \ [] : ; = , + * ? < > @ "

Note — The Web Security appliance supports the percent (%) character for end users browsing the web. However, you cannot use a user name with the percent (%) character to join the Active Directory domain when you create an NTLM authentication realm.

Table 17-17 lists the characters the Web Security appliance supports for the Password field for Active Directory servers.

Table 17-17 Supported Active Directory Server Characters — Password Field

Supported Characters	Characters Not Supported
A...Z a...z 0 1 2 3 4 5 6 7 8 9 ` ~ ! # \$ ^ & () _ - { } ' . / [] : * ? @ + \ , ; " = < > space	N/A

Table 17-18 lists the characters the Web Security appliance supports for the Location field for Active Directory servers. You enter the location string in the Location field when you configure an NTLM authentication realm.

Table 17-18 Supported Active Directory Server Characters — Location Field

Supported Characters	Characters Not Supported
A...Z a...z 0 1 2 3 4 5 6 7 8 9 ` ~ ! # \$ % ^ & () _ - { } ' . / [] : * ? @ space	+ \ , ; " = < > Note: The appliance does not support these characters even when they are escaped with a backslash (\) character.

Table 17-19 lists the characters the Web Security appliance supports for the Group field for Active Directory servers.

Table 17-19 Supported Active Directory Server Characters — Group Field

Supported Characters	Characters Not Supported
A...Z a...z 0 1 2 3 4 5 6 7 8 9 ` ~ ! # \$ % ^ & () _ - { } ' . @ space	/ \ [] : ; = , + * ? < > "

Note — You can only use the backslash (\) character as a separator between the domain name and a user or group name, or as a separator between organizational units (OU) in the location string for an Active Directory server. You cannot use it as part of a domain name, user name, group name, or location name.

LDAP Server Supported Characters

Table 17-20 lists the characters the Web Security appliance supports for the User Name field for LDAP servers.

Table 17-20 Supported LDAP Server Characters — User Name Field

Supported Characters	Characters Not Supported
A...Z a...z 0 1 2 3 4 5 6 7 8 9 ` ~ ! # \$ % ^ & () _ - { } ' . Note: The appliance only supports the '(' and ')' characters when they are escaped with a backslash (\) character.	/ \ [] : ; = , + * ? < > @ "

Table 17-21 lists the characters the Web Security appliance supports for the Password field for LDAP servers.

Table 17-21 Supported LDAP Server Characters — Password Field

Supported Characters	Characters Not Supported
A...Z a...z 0 1 2 3 4 5 6 7 8 9 ` ~ ! # \$ % ^ & () _ - { } @ ' . / \ [] : = * ? < > " , ; + space	N/A

Table 17-22 lists the characters the Web Security appliance supports for the Group field for LDAP servers.

Table 17-22 Supported LDAP Server Characters — Group Field

Supported Characters	Characters Not Supported
A...Z a...z 0 1 2 3 4 5 6 7 8 9 ` ~ ! # \$ % ^ & () _ - { } @ ' . / \ [] : = * ? < > " space Note: The appliance only supports the '(' and ')' characters when they are escaped with a backslash (\) character.	, ; +

Table 17-23 lists the characters the Web Security appliance supports for the Custom User Filter Query Field field for LDAP servers.

Table 17-23 Supported LDAP Server Characters — Custom User Filter Query Field

Supported Characters	Characters Not Supported
A...Z a...z 0 1 2 3 4 5 6 7 8 9 ` ~ ! # \$ % ^ & () _ - { } ' . space	@ / \ [] : = * ? < > " , ; +

Table 17-24 lists the characters the Web Security appliance supports for the Custom Group Filter Query Field field for LDAP servers.

Table 17-24 Supported LDAP Server Characters — Custom Group Filter Query Field

Supported Characters	Characters Not Supported
A...Z a...z 0 1 2 3 4 5 6 7 8 9 ` ~ ! # \$ % ^ & () _ - { } @ ' . / \ [] : = * ? < > " space	, ; +

L4 Traffic Monitor

This chapter contains the following information:

- “About L4 Traffic Monitor” on page 406
- “How the L4 Traffic Monitor Works” on page 407
- “Configuring the L4 Traffic Monitor” on page 409
- “Viewing L4 Traffic Monitor Activity” on page 413

ABOUT L4 TRAFFIC MONITOR

The Web Security appliance has an integrated Layer-4 Traffic Monitor that detects rogue traffic across all network ports and stops malware attempts to bypass port 80. Additionally, when internal clients are infected with malware and attempt to phone-home across non-standard ports and protocols, the L4 Traffic Monitor prevents phone-home activity from going outside the corporate network.

HOW THE L4 TRAFFIC MONITOR WORKS

The L4 Traffic Monitor listens to network traffic that comes in over all ports on the appliance and matches domain names, and IP addresses against entries in its own database tables to determine whether to allow incoming and outgoing traffic.

All web destinations fall under one of the following categories:

- **Known allowed address.** Any IP address or host name listed in the Allow List property. These addresses appear in the log files as “whitelist” addresses.
- **Unlisted address.** Any IP address that is not known to be a malware site nor is a known allowed address. They are not listed on the Allow List or Additional Suspected Malware Addresses properties, nor are they listed in the L4 Traffic Monitor Database as a known malware site. These addresses do not appear in the log files.
- **Ambiguous address.** These addresses appear in the log files as “greylist” addresses. They include any of the following addresses:
 - Any *IP address* that is associated with both an unlisted *host name* and a known malware *host name*.
 - Any *IP address* that is associated with both an unlisted *host name* and a *host name* from the Additional Suspected Malware Addresses property.
- **Known malware address.** These addresses appear in the log files as “blacklist” addresses. They include any of the following addresses:
 - Any IP address or host name that the L4 Traffic Monitor Database determines to be a known malware site and *not* listed in the Allow List.
 - Any *IP address* that is listed in the Additional Suspected Malware Addresses property and *not* listed in the Allow List and *not* determined to be ambiguous.

Note — You can define the Allow List and the Additional Suspected Malware Addresses properties on the Web Security Manager > L4 Traffic Monitor Policies page.

The L4 Traffic Monitor listens to and monitors network ports for rogue activity. It performs one of the following actions on all traffic on your network:

- **Allow.** It always allows traffic to and from known allowed and unlisted addresses.
- **Monitor.** It monitors traffic under the following circumstances:
 - When the Action for Suspected Malware Addresses option is set to Monitor, it always monitors all traffic that is not to or from a known allowed address.
 - When the Action for Suspected Malware Addresses option is set to Block, it monitors traffic to and from ambiguous addresses.
- **Block.** When the Action for Suspected Malware Addresses option is set to Block, it blocks traffic to and from known malware addresses.

The L4 Traffic Monitor Database

The L4 Traffic Monitor uses and maintains its own internal database. This database is continuously updated with matched results for IP addresses and domain names. Additionally, the database table receives periodic updates from the IronPort update server at the following location:

<https://update-manifests.ironport.com>

For information about update intervals and the IronPort update server, see “Manually Updating Security Service Components” on page 545.

CONFIGURING THE L4 TRAFFIC MONITOR

The L4 Traffic Monitor can be enabled as part of an initial system setup using the System Setup Wizard. By default, the L4 Traffic Monitor is enabled and set to monitor traffic on all ports. This includes DNS and other services.

Note — To monitor true client IP addresses, the L4 Traffic Monitor should always be configured inside the firewall and before network address translation (NAT). For more information about deploying the L4 Traffic Monitor, see “Deploying the L4 Traffic Monitor” on page 41.

You can configure the following settings:

- **Global L4 Traffic Monitor settings.** You can enable or disable the L4 Traffic Monitor after an initial configuration and configure which TCP ports to monitor. Use the Security Services > L4 Traffic Monitor page. For more information see “Configuring L4 Traffic Monitor Global Settings” on page 409.
- **L4 Traffic Monitor policies.** When the L4 Traffic Monitor is enabled, you configure specific policies for managing traffic. Use the Web Security Manager > L4 Traffic Monitor Policies page. For more information see “Configuring L4 Traffic Monitor Policies” on page 410.

Configuring L4 Traffic Monitor Global Settings

On the Security Services > L4 Traffic Monitor page, you can configure the L4 Traffic Monitor global settings and update the L4 Traffic Monitor anti-malware rules.

Figure 18-1 Security Services > L4 Traffic Monitor Page

L4 Traffic Monitor

L4 Traffic Monitor Global Settings		
L4 Traffic Monitor Status:	Enabled	
Traffic Monitored On:	All Ports	
Edit Global Settings...		

IronPort L4 Anti-Malware Rules Update		
Update Type	Last Update	Current Version
L4 Traffic Monitor Anti-Malware Rules	never updated	1.0
Update Now		

To configure L4 Traffic Monitor global settings:

1. Navigate to the Security Services > L4 Traffic Monitor page.
2. Click Edit Global Settings.
3. Choose whether or not to enable the L4 Traffic Monitor.
4. When you enable the L4 Traffic Monitor, choose which ports it should monitor:
 - **All ports.** Monitors all 65535 TCP ports for rogue activity.

- **All ports except proxy ports.** Monitors all TCP ports except the following ports for for rogue activity.
 - Ports configured in the “HTTP Ports to Proxy” property on the Security Services > Proxy Settings page (usually port 80).
 - Ports configured in the “Transparent HTTPS Ports to Proxy” property on the Security Services > HTTPS Proxy page (usually port 443).
5. Submit and commit the changes.

Updating L4 Traffic Monitor Anti-Malware Rules

To update the L4 Traffic Monitor anti-malware rules:

1. Navigate to the Security Services > L4 Traffic Monitor page.
2. Click **Update Now**.

The Web Security appliance contacts the component update server and updates the L4 Traffic Monitor anti-malware rules. For more information about the component update server, see “Manually Updating Security Service Components” on page 545.

Configuring L4 Traffic Monitor Policies

When the L4 Traffic Monitor is enabled, you can configure how it should manage traffic over the configured TCP ports. It can perform the following actions on traffic over the TCP ports:

- Allow
- Monitor
- Block

For more information about how the L4 Traffic Monitor handles traffic, see “How the L4 Traffic Monitor Works” on page 407.

The actions the L4 Traffic Monitor takes depends on the L4 Traffic Monitor policies you configure.

To configure L4 Traffic Monitor policies:

1. Navigate to the Web Security Manager > L4 Traffic Monitor page.
2. Click **Edit Settings**.

- On the Edit L4 Traffic Monitor Policies page, configure the L4 Traffic Monitor policies described in Table 18-1.

Table 18-1 L4 Traffic Monitor Policies

Property	Description
Allow List	<p>Enter zero or more address to which the L4 Traffic Monitor should always allow clients to connect.</p> <p>Separate multiple entries with a space or comma. For a list of valid address formats you can use, see “Valid Formats” on page 412.</p> <p>Note: Entering a domain name such as example.com also matches www.example.com and hostname.example.com.</p> <p>Connections to all destinations in this list are always allowed and the traffic is not logged. The appliance does not check the destinations against the L4 Traffic Monitor anti-malware rules or the additional suspected malware addresses listed on the same page.</p> <p>For example, if IP address 10.1.1.1 appears in both the Allow List and the Additional Suspected Malware Addresses fields, then the L4 Traffic Monitor always allows requests for 10.1.1.1.</p>
Actions for Suspected Malware Addresses	<p>Choose whether to monitor or block traffic destined for a known malware address. For a definition of known malware address, see “How the L4 Traffic Monitor Works” on page 407.</p> <ul style="list-style-type: none"> • Monitor. Scans all traffic for domains and IP addresses that match entries in the L4 Traffic Monitor database. The Monitor option does not block suspicious traffic. This setting is useful for identifying infected clients without affecting the user experience. • Block. Scans all traffic for domains and IP addresses that match entries in the appliance administrative lists and the block list database and then blocks any traffic it finds. This setting is useful for identifying infected clients and stopping malware attempts through non-standard ports. <p>When you choose to block suspected malware traffic, you can also choose whether or not to always block ambiguous addresses. By default, ambiguous addresses are monitored.</p> <p>For a definition of ambiguous address, see “How the L4 Traffic Monitor Works” on page 407.</p>

Table 18-1 L4 Traffic Monitor Policies

Property	Description
Additional Suspected Malware Addresses (optional)	<p>Enter zero or more known addresses that the L4 Traffic Monitor should consider as a possible malware. For a list of valid address formats you can use, see “Valid Formats” on page 412.</p> <p>If you choose to block suspected malware addresses, the L4 Traffic Monitor will either block or monitor these addresses depending on whether it determines them to be known malware addresses or ambiguous addresses. For definitions of ambiguous and known malware addresses, see “How the L4 Traffic Monitor Works” on page 407.</p> <p>If you choose to monitor suspected malware addresses, it will monitor these addresses.</p> <p>Note: Adding internal IP addresses to the Additional Suspected Malware Addresses list causes legitimate destination URLs to show up as malware in L4 Traffic Monitor reports. To avoid this type of erroneous reporting, do not enter internal IP addresses in the “Additional Suspected Malware Addresses” field on the Web Security Manager > L4 Traffic Monitor Policies page.</p>

Note — If the L4 Traffic Monitor is configured to block, the L4 Traffic Monitor and the Web Proxy must be configured on the same network. Use the Network > Routes page to confirm that all clients are accessible on routes that are configured for data traffic.

4. Submit and commit your changes.

Valid Formats

When you add addresses to the Allow List or Additional Suspected Malware Addresses properties, separate multiple entries with whitespace or commas. You can enter addresses in any of the following formats:

- **IP address.** For example, 10.1.1.0.
- **CIDR address.** For example, 10.1.1.0/24.
- **Domain name.** For example, example.com. Entering a domain name such as example.com will also match www.example.com and hostname.example.com.
- **Hostname.** For example, crm.example.com.

VIEWING L4 TRAFFIC MONITOR ACTIVITY

The S-Series appliance supports several options for generating feature specific reports and interactive displays of summary statistics.

Reports

You can use options on the Monitor > Reports pages of the web interface to select a type of report, capture data, schedule periodic email delivery, and archive reports.

For more information about working with reports, see “Reporting Overview” on page 434.

Monitoring Activity and Viewing Summary Statistics

The Monitor > L4 Traffic Monitor page provides statistical summaries of monitoring activity. You can interactively update these displays by specifying a time range of hour, day, week or month. Additionally, you have the option to print these display pages and export the raw data to a file.

You can use the following displays and reporting tools to view the results of L4 Traffic Monitor activity:

Table 18-2 L4 Traffic Monitor Scanning Data

To view...	See...
Client statistics	Monitor > Client Activity
Malware statistics Port statistics	Monitor > L4 Traffic Monitor
L4 Traffic Monitor log files	System Administration > Log Subscriptions <ul style="list-style-type: none"> • trafmon_errlogs • trafmonlogs

Note — If the Web Proxy is configured as a forward proxy and L4 Traffic Monitor is set to monitor all ports, the IP address of the proxy’s data port is recorded and displayed as a client IP address in the client activity report on the Monitor > Client Activity page. If the Web Proxy is configured as a transparent proxy, enable IP spoofing to correctly record and display the client IP addresses.

L4 Traffic Monitor Log File Entries

The L4 Traffic Monitor log file provides a detailed record of monitoring activity. For more information about the L4 Traffic Monitor log, see “Traffic Monitor Log” on page 482.

Monitoring

This chapter contains the following information:

- “Monitoring System Activity” on page 416
- “Using the Monitor Tab” on page 417
- “Overview Page” on page 419
- “L4 Traffic Monitor Data Page” on page 420
- “Clients Pages” on page 421
- “Web Site Activity Page” on page 422
- “Anti-Malware Page” on page 423
- “URL Categories Page” on page 424
- “Web Reputation Filters Page” on page 425
- “System Status Page” on page 426
- “SNMP Monitoring” on page 427

MONITORING SYSTEM ACTIVITY

Administrators and executive management require information to better understand evolving corporate threats. While the Web Security appliance controls the malware threat to a corporate environment, comprehensive monitoring and reporting tools provide insight to threats that are monitored or blocked, and display actionable data such as top clients infected to help you manage the presence of malware.

The chapter introduces you to the monitoring tools you can use to monitor system activity and help you interpret data specific to each Web Security appliance security component. The Monitor tab contains a collection of system data and graphical displays for the following types of information:

- **Security Services** — Summary displays of transaction data derived from the results of filtering policies.
- **Suspect Transactions Detected** — Summary charts that represent the percentages of traffic that was blocked by S-Series filtering and scanning features.
- **Top Sites by Malware** — Categorical displays of monitored and blocked transactions to web sites containing malware.
- **High-Risk and Malware Activity** — Summary displays of client malware activity and high-risk web sites.

Note — You can also use appliance reports to monitor appliance activity. For more information about creating and using reports, see “Reporting” on page 433.

USING THE MONITOR TAB

The Monitor tab provides several options for viewing system data. This section describes those options and explains the information displayed on each of the following pages: Overview, L4 Traffic Monitor, Client Web Activity, Client Malware Risk, Web Site Activity, Anti-Malware, URL Categories, and Web Reputation Filters.

Monitor tab display pages provide a colorful overview of system activity and support multiple options for viewing system data. For example, you can update and sort data to provide real-time visibility into resource utilization and web traffic trouble spots. You can also search each page for web site and client-specific data.

Changing the Timeframe

You can update the data displayed for each security component using the Time-Range field. This option allows you to generate updates for the last hour, day, week, or 30-day period. For example:

Figure 19-1 Selecting Data Time Range

Anti-Malware

[Printable \(PDF\)](#)



The image shows a screenshot of the Anti-Malware monitor tab. At the top left, the title "Anti-Malware" is displayed. To the right of the title is a link labeled "Printable (PDF)". Below the title, there is a "Time Range:" label followed by a dropdown menu. The dropdown menu is currently set to "Day".

Report data is displayed as follows:

Table 19-1 Time Intervals for Data Collection

For this time increment...	Data is returned in...
Hour	Sixty (60) complete minutes plus up to 5 additional minutes.
Day	One hour intervals for the last 24 hours and including the current partial hour.
Week	One day intervals for the last 7 days plus the current partial day.
Month (30 days)	One day intervals for the last 30 days plus the current partial day.

Note — All reports display date and time information based on the systems configured time zone, shown as a Greenwich Mean Time (GMT) offset. However, data exports display the time in GMT to accommodate multiple systems in multiple time zones around the world.

Searching Data

The Search option at the bottom of each display page returns data for a particular web site or client.

Figure 19-2 Searching for Web Sites or Clients



The image shows a search interface with a light gray background. On the left, the text "Search for:" is followed by a dropdown menu currently set to "Client". To the right of the dropdown is a white text input field. Further right is another dropdown menu set to "exact match". To the far right is a dark blue button with the word "Search" in white text.

You can search for an exact match of a web site, client IP address or user ID, or you can search for web sites or clients that start with a specific text string.

Note — You need to configure authentication to view client user IDs instead of client IP addresses.

OVERVIEW PAGE

The Monitor > Overview page displays the Overview report. This report contains highlights of the System Status report and provides summary system traffic and security risk summary data.

The following sections appear on the Overview report:

Overview Report Section	Description
System Overview	<p>Displays the following information:</p> <ul style="list-style-type: none"> • Web Proxy traffic characteristics, including per-minute data averages for client transactions, system bandwidth, average system response time, and total current connections. • System resource utilization statistics. <p>Use the System Status Details link to access the full System Status report.</p>
Total Web Activity	<p>Compares total clean transactions and total suspect transactions in a trend graph over time. Suspect transactions include all monitored and blocked transactions.</p>
Suspect Transactions Detected	<p>Compares various types of suspect transactions in a trend graph over time.</p>
Security Services Summary	<p>Displays the following information:</p> <ul style="list-style-type: none"> • Web Proxy total suspect transactions and suspect transactions by type. Suspect transactions include requests blocked URL category, requests blocked by Web Reputation Filters, transactions detected by Anti-Malware scanning, and other blocked transactions. "Other blocked transactions" includes transactions blocked by various policy settings such as the file size limit. • L4 Traffic Monitor suspect connections. For information about the specific monitored and blocked transactions, see "L4 Traffic Monitor Data Page" on page 420.
Top URL Categories	<p>Lists the top 10 URL categories matched for the specified time range. For more information, see "URL Categories Page" on page 424.</p>
Top Malware Categories	<p>Lists the top 10 malware categories detected for the specified time range. For more information, see "Anti-Malware Page" on page 423.</p>

Export links that are visible on each page, are used to export raw data. For more information, see "Exporting Report Data" on page 439.

L4 TRAFFIC MONITOR DATA PAGE

The Monitor > L4 Traffic Monitor page displays information about malware ports and malware sites that the L4 Traffic Monitor detected during the specified time range. The upper part of the report displays the number of connections for each of the top malware ports and web sites. The lower part of the report displays malware ports and sites detected.

For information about malware detected by the Anti-Malware DVS engine, see “Anti-Malware Page” on page 423.

CLIENTS PAGES

You can use the following pages to monitor client activity:

- Monitor > Clients > Web Activity page — This page shows the Client Web Activity report, which includes the following information:
 - Top clients by total web transactions
 - Top clients by blocked web transactions

The client details table provides additional details including, bandwidth usage and the amount of bandwidth saved by blocking.

The user ID's and client IP addresses are interactive and link to a Client Detail page that provides information respective to each client.

- Monitor > Clients > Malware Risk page — This page shows the Client Malware Risk report, which includes the following information:
 - Web Proxy top clients by malware risk (number of transactions)
 - L4 Traffic Monitor top clients by malware risk (number of connections)

The client details at the bottom of the page display the same data as the graphs, but for *all* clients and in table format. In addition, the All tab for Web Proxy transactions provides information about the bandwidth that was saved by blocking, and it shows how many monitored and blocked malware transactions were detected at request time or detected at response time.

The user ID's and client IP addresses are interactive and link to a Client Detail page that provides detailed information respective to each client.

- Client Detail page — This page shows all the web activity and malware risk data for a particular client during the specified time range. It includes the following information:
 - Completed and blocked web transactions
 - Web Proxy monitored and blocked malware transactions
 - L4 Traffic Monitor malware connections
 - URL categories matched
 - Malware threats detected
 - Suspect user agents detected

Note — The client reports sometimes show a user with an asterisk (*) at the end of the user name. For example, the Client Web Activity report might show an entry for both “jsmith” and “jsmith*”. User names listed with an asterisk (*) indicate the user name provided by the user, but not confirmed by the authentication server. This happens when the authentication server was not available at the time and the appliance is configured to permit traffic when authentication service is unavailable.

WEB SITE ACTIVITY PAGE

Use the following pages to monitor high-risk web sites accessed during a specific time range:

- Monitor > Web Site Activity page — This page shows the Web Site Activity report, which includes the following information:
 - Top five sites by high-risk transactions detected. A high-risk transaction is any monitored or blocked transaction.
 - Top five sites by malware transactions detected.

The site details section at the bottom of the page lists all of the sites with high-risk transactions. You can use column headings to sort the data and each URL links to the Web Site Detail page.

- Web Site Detail page — This page shows the high-risk transactions for the site in a trend graph that uses a different color for each type of high-risk transaction.

The Summary tab shows the same information as the trend graph, but in table format. It shows the transactions blocked by URL filtering, transactions blocked by Web Reputation Filters, transactions detected by Anti-Malware scanning, other blocked transactions, total high-risk transactions, and URL categories of the site. The All tab displays bandwidth saved by blocking and includes detail about transactions detected by Anti-Malware scanning.

The Other Blocked Transactions column displays transactions blocked by a policy rule. This data includes the following conditions:

- File size over limit
- File type not allowed
- User agent not allowed
- Protocol not allowed
- Authentication denied
- Attempted HTTP tunneling (CONNECT) on disabled port

User agents blocked by a policy configuration are recorded as “other blocked transactions.” Suspect user agents detected by the Anti-Malware DVS engine are recorded as blocked by Anti-Malware scanning.

ANTI-MALWARE PAGE

Use the following pages to monitor malware detected by the Anti-Malware DVS engine:

- **Monitor > Anti-Malware page** — This page shows the Anti-Malware report, which includes the following information:
 - Top malware categories detected (by number of transactions)
 - Top malware threats detected (by number of transactions)

The Malware Categories and Malware Threats sections show the same data as the graphs, but in table format. In addition, these sections include information about the bandwidth saved by blocking.

- **Malware Category page** — The name of a malware category on the Anti-Malware report is a link to the Malware Category page. The Malware Category report shows detailed information about a particular malware category. The trend graph at the top of the report shows the monitored and blocked transactions for the category during the specified time range. The table at the bottom lists the detected malware threats that belong to the malware category and shows the number of monitored and blocked transactions for each.
- **Malware Threat page** — The name of a malware threat on either the Anti-Malware report or the Malware Category report is a link to the Malware Threat page. The Malware Threat report shows clients at risk for a particular threat, displays a list of potentially infected clients, and links to the Client Detail page. The trend graph at the top of the report shows monitored and blocked transactions for a threat during the specified time range. The table at the bottom shows the actual number of monitored and blocked transactions for a threat during the specified time range.

URL CATEGORIES PAGE

Use the Monitor > URL Categories page to view the URL Categories report. This report shows the top 10 URL categories by completed transactions and the top 10 URL categories by blocked transactions for a specified time range. Completed transactions include both clean transactions and monitored transactions.

The URL Categories Matched section shows all matched categories during a specified time range for both completed and blocked transactions. You can use column headings to sort data, and the Items Displayed menu changes the number of URL categories displayed in the list.

The percentage of uncategorized URLs in the URL Categories report is typically around 15-20%. If the percentage of uncategorized URLs is higher than that, consider the following options:

- For specific localized URLs, you can create custom URL categories and apply them to specific users or group policies. For more information, see “Custom URL Categories” on page 301.
- You can report misclassified and uncategorized URLs to the IronPort support portal at the following URL:
`https://supportportal.ironport.com/irppcnctr/srvcd?u=http://secure-support.soma.ironport.com/subproducts/s_series&sid=900019#`
These get picked up and get evaluated for subsequent rule updates.
- Verify Reputation Filtering and Anti-Malware Filtering is enabled. Often times, the correlation between malware and URLs with suspect content is high and it is likely that they may get caught by subsequent filters. The system pipeline is set up to catch malicious traffic with other downstream filters if URL filtering does not have a verdict.

WEB REPUTATION FILTERS PAGE

Use the Monitor > Web Reputation Filters page to view the Web Reputation Filters report. This report shows the result of Web Reputation filtering for transactions during a specified time range.

The Web Reputation Actions trend graph compares the following types of web reputation actions during the specified time range:

- Block
- Scan Further: Malware Detected
- Scan Further: Clean
- Allow

The Web Reputation Actions (Volume) section displays the data as percentages in table format.

The Web Reputation Filters report also shows the configured score ranges for the Block, Scan Further, and Allow actions. In addition, it displays a breakdown by score for each filtered transaction.

Note — If the result of Web Reputation filtering is to Scan Further, the transaction is passed to the Anti-Malware DVS engine for additional scanning.

SYSTEM STATUS PAGE

Use the Monitor > System Status page to monitor the System Status. This page displays the current status and configuration of the Web Security appliance. The following table describes each display.

Table 19-2 System Status

This Section...	Displays
Web Security Appliance Status	<ul style="list-style-type: none">• System uptime• System resource utilization — CPU usage, RAM usage, and percentage of disk space used for reporting and logging.
Proxy Traffic Characteristics	<ul style="list-style-type: none">• Transactions per second• Bandwidth• Response time• Cache hits• Connections
Current Configuration	Web Proxy settings: <ul style="list-style-type: none">• Web Proxy Status — enabled or disabled.• Deployment Topology.• Web Proxy Mode — forward or transparent.• IP Spoofing — enabled or disabled. L4 Traffic Monitor settings: <ul style="list-style-type: none">• L4 Traffic Monitor Status — enabled or disabled.• L4 Traffic Monitor Wiring.• L4 Traffic Monitor Action — monitor or block.

SNMP MONITORING

The IronPort AsyncOS operating system supports system status monitoring via SNMP (Simple Network Management Protocol). This includes IronPort's Enterprise MIB, `asyncoswebsecurityappliance-mib.txt`. The `asyncoswebsecurityappliance-mib` helps administrators better monitor system health. In addition, this release implements a read-only subset of MIB-II as defined in RFCs 1213 and 1907. (For more information about SNMP, see RFCs 1065, 1066, and 1067.) Please note:

- SNMP is **off** by default.
- SNMP SET operations (configuration) are not implemented.
- AsyncOS supports SNMPv1, v2, and v3.
- The use of SNMPv3 with password authentication and DES Encryption is mandatory to enable this service. (For more information on SNMPv3, see RFCs 2571-2575.) You are required to set a SNMPv3 passphrase of at least 8 characters to enable SNMP system status monitoring. The first time you enter a SNMPv3 passphrase, you must re-enter it to confirm. The `snmpconfig` command "remembers" this phrase the next time you run the command.
- The SNMPv3 username is: `v3get`.

```
> snmpwalk -v 3 -l AuthNoPriv -u v3get -a MD5 ironport serv.example.com
```

- If you use only SNMPv1 or SNMPv2, you must set a community string. The community string does not default to `public`.
- For SNMPv1 and SNMPv2, you must specify a network from which SNMP GET requests are accepted.
- To use traps, an SNMP manager (not included in AsyncOS) must be running and its IP address entered as the trap target. (You can use a hostname, but if you do, traps will only work if DNS is working.)

Use the `snmpconfig` command to configure SNMP system status for the appliance. After you choose and configure values for an interface, the appliance responds to SNMPv3 GET requests. These version 3 requests must include a matching password. By default, version 1 and 2 requests are rejected. If enabled, version 1 and 2 requests must have a matching community string.

MIB Files

IronPort Systems provides "enterprise" MIBs for Email and Web Security appliances as well as a "Structure of Management Information" (SMI) file:

- `asyncoswebsecurityappliance-mib.txt` — an SNMPv2 compatible description of the Enterprise MIB for IronPort Web Security appliances.

- ASYNCOS-MAIL-MIB.txt — an SNMPv2 compatible description of the Enterprise MIB for IronPort Email Security appliances.
- IRONPORT-SMI.txt — defines the role of the asyncoswebsecurityappliance-mib in IronPort’s SNMP managed products.

These files are available on the documentation CD included with your IronPort appliance. You can also find these files on the IronPort Customer Support portal.

Hardware Objects

Hardware sensors conforming to the Intelligent Platform Management Interface Specification (IPMI) report temperature, fan speed, and power supply status.

Table 19-3 shows what hardware derived objects are available for monitoring on what models. The number displayed is the number of instances of that object that can be monitored. For example, you can query the RPMs for 4 fans in the S350 appliance.

Table 19-3 Number of Hardware Objects per IronPort Appliance

Model	Ambient Temp	Fans	Power Supply	Disk Status	NIC Link
S160	1	2	1	2	6
S350	1	4	2	6	6
S360	1	4	2	4	6
S650	1	4	2	6	6
S660	1	4	2	6	6

Hardware Traps

Table 19-4 lists the temperature and hardware conditions that cause a hardware trap to be sent:

Table 19-4 Hardware Traps: Temperature and Hardware Conditions

Model	High Temp (Ambient)	Fan Failure	Power Supply	RAID	Link
S160/ S350/ S360/ S650/ S660	47C	0 RPMs	Status Change	Status Change	Status Change

Status change traps are sent when the status changes. Fan Failure and high temperature traps are sent every 5 seconds. The other traps are failure condition alarm traps — they are sent once when the state changes (healthy to failure). It is a good idea to poll for the hardware status tables and identify possible hardware failures before they become critical. Temperatures within 10 per cent of the critical value may be a cause for concern.

Note that failure condition alarm traps represent a critical failure of the individual component, but may not cause a total system failure. For example, a single fan or power supply can fail on a S650 appliance and the appliance will continue to operate.

SNMP Traps

SNMP provides the ability to send traps, or notifications, to advise an administration application (an SNMP management console, typically) when one or more conditions have been met. Traps are network packets that contain data relating to a component of the system sending the trap. Traps are generated when a condition has been met on the SNMP agent (in this case, the IronPort appliance). After the condition has been met, the SNMP agent then forms an SNMP packet and sends it over port 162, the standard SNMP trap port. In the example below, the trap target of 10.1.1.29 and the Trap Community string are entered. This is the host running the SNMP management console software that will receive the SNMP traps from the IronPort appliance.

You can configure SNMP traps (enable or disable specific traps) when you enable SNMP for an interface. To specify multiple trap targets: when prompted for the trap target, you may enter up to 10 comma separated IP addresses.

CLI Example

In the following example, the `snmpconfig` command is used to enable SNMP on the “PublicNet” interface on port 161. A passphrase for version 3 is entered and then re-entered for confirmation. The system is configured to service version 1 and 2 requests, and the community string `public` is entered for GET requests from those versions 1 and 2. The trap target of 10.1.1.29 is entered. Finally, system location and contact information is entered.

```
example.com> snmpconfig
Current SNMP settings:
SNMP Disabled.

Choose the operation you want to perform:
- SETUP - Configure SNMP.
[ ]> setup

Do you want to enable SNMP? [N]> y

Please choose an IP interface for SNMP requests.
1. Management (192.168.1.1/24: wsa01-vmw1-tpub.qa)
[1]>

Enter the SNMPv3 passphrase.
```

```
>
Please enter the SNMPv3 passphrase again to confirm.
>
Which port shall the SNMP daemon listen on?
[161]>

Service SNMP V1/V2c requests? [N]> y

Enter the SNMP V1/V2c community string.
[ ]> public

From which network shall SNMP V1/V2c requests be allowed?
[192.168.1.1]>

Enter the Trap target as a host name, IP address or list of IP
addresses separated by commas (IP address preferred). Enter "None" to
disable traps.
[None]> 10.1.1.29

Enter the Trap Community string.
[ ]> tcomm

Enterprise Trap Status
1. CPUUtilizationExceeded      Disabled
2. RAIDStatusChange           Enabled
3. connectivityFailure         Disabled
4. fanFailure                  Enabled
5. highTemperature             Enabled
6. keyExpiration               Enabled
7. linkDown                    Enabled
8. linkUp                      Enabled
9. memoryUtilizationExceeded   Disabled
10. powerSupplyStatusChange    Enabled
11. resourceConservationMode    Enabled
12. updateFailure              Enabled
13. upstream_proxy_failure     Enabled

Do you want to change any of these settings? [N]> y

Do you want to disable any of these traps? [Y]> n

Do you want to enable any of these traps? [Y]> y

Enter number or numbers of traps to enable. Separate multiple numbers
with commas.
[ ]> 1,3
```



```
What threshold would you like to set for CPU utilization?
[95]>

What URL would you like to check for connectivity failure?
[http://downloads.ironport.com]>

Enterprise Trap Status
1. CPUUtilizationExceeded      Enabled
2. RAIDStatusChange           Enabled
3. connectivityFailure         Enabled
4. fanFailure                  Enabled
5. highTemperature             Enabled
6. keyExpiration               Enabled
7. linkDown                    Enabled
8. linkUp                      Enabled
9. memoryUtilizationExceeded  Disabled
10. powerSupplyStatusChange    Enabled
11. resourceConservationMode   Enabled
12. updateFailure              Enabled
13. upstream_proxy_failure     Enabled
Do you want to change any of these settings? [N]>

Enter the System Location string.
[Unknown: Not Yet Configured]> Network Operations Center - west; rack
#30, position 3

Enter the System Contact string.
[snmp@localhost]> Joe Administrator, x8888

Current SNMP settings:
Listening on interface "Management" 192.168.1.1 port 161.
SNMP v3: Enabled.
SNMP v1/v2: Enabled, accepting requests from subnet 192.168.1.1.
SNMP v1/v2 Community String: public
Trap target: 10.1.1.29
Location: Network Operations Center - west; rack #30, position 3
System Contact: Joe Administrator, x8888

Choose the operation you want to perform:
- SETUP - Configure SNMP.
[ ]>

example.com>
```

Reporting

This chapter contains the following information:

- “Reporting Overview” on page 434
- “Scheduling Reports” on page 435
- “On-Demand Reports” on page 437
- “Archiving Reports” on page 438
- “Exporting Report Data” on page 439

REPORTING OVERVIEW

Reporting functionality aggregates information from individual security features and records data that can be used to monitor your web traffic patterns and security risks. You can run reports in real-time to view an interactive display of system activity over a specific period of time, or you can schedule reports and run them at regular intervals. Reporting functionality also allows you to export raw data to a file. For more information see, “Exporting Report Data” on page 439.

SCHEDULING REPORTS

You can schedule reports to run on a daily, weekly, or monthly basis. Scheduled reports can be configured to include data for the previous day, previous seven days, or previous month. Alternatively, you can include data for a custom number of days (from 2 days to 100 days) or a custom number of months (from 2 months to 12 months).

Regardless of when you run a report, the data is returned from the previous time interval (hour, day, week, or month). For example, if you schedule a daily report to run at 1AM, the report will contain data from the previous day, midnight to midnight (00:00 to 23:59).

Adding a Scheduled Report

Use the Monitor > Reports > Add Scheduled Report page to schedule reporting for Anti-Malware, Client Malware Risk, Client Web Activity, L4 Traffic Monitor, Overview, URL Categories, Web Reputation Filters, Web Site Activity.

Figure 20-1 Scheduling Reports

Add Scheduled Report

Report Settings	
Type:	Select report type... ▾
Title:	<input type="text"/>
Time Range To Include:	Previous 7 calendar days ▾
Schedule:	<input type="radio"/> Daily At time: <input type="text" value="01"/> : <input type="text" value="00"/> <input checked="" type="radio"/> Weekly on <input type="text" value="Sunday"/> ▾ <input type="radio"/> Monthly (on first day of month)
Email to:	<input type="text"/> <small>Separate multiple addresses with commas. Leave blank for archive only.</small>

To create a scheduled report:

1. Select a report type.
2. Enter a title for the report. To avoid creating multiple reports with the same name, consider using a descriptive title.
3. Select a time range for the data included in the report.
4. Specify report options, if available. Some reports do not have report options.
5. Specify scheduling and delivery options. If you do not specify an email address, the report is archived only.
6. Submit and commit your changes.

Editing Scheduled Reports

To edit reports, select the report title from the list on the Monitor > Report Scheduling page, modify settings then submit and commit your changes.

Deleting Scheduled Reports

To delete reports, go to the Monitor > Report Scheduling page and select the check boxes corresponding to the reports that you want to delete. To remove all scheduled reports, select the All check box, **Delete** and **Commit** your changes. Note that archived versions of deleted reports are not deleted.

ON-DEMAND REPORTS

The Generate Report Now option on the Monitor > Archived Reports page allows you to generate on-demand data displays for each report type. To generate a report:

1. Select **Generate Report Now**

Figure 20-2 Generating an On-Demand Report

Generate Report

Generate Report	
Report Type:	Select report type... View This Report 
Title:	<input type="text"/>
Time Range To Include:	Previous 7 calendar days ▼
Number of Rows:	Include top 10 ▼
Delivery Options:	<input type="checkbox"/> Archive <input type="checkbox"/> Email now to recipients: <input type="text"/> <small>Separate multiple addresses with commas.</small>
← Back to Archived Reports Deliver This Report	

2. Select a report type and edit the title, if necessary. To avoid creating multiple reports with the same name, consider using a descriptive title.
3. Select a time range for the data included in the report.
4. Specify report options, if available.
5. Select whether to archive the report (if so, the report will appear on the Archived Reports page).
6. Specify whether to email the report, and list the email addresses of the recipients.
7. **View This Report** immediately displays the information without having it archived or forwarded to an email distribution list.
8. **Deliver this Report** generates the report.
9. Commit your changes.

ARCHIVING REPORTS

The Monitor > Archived Reports page lists available archived reports. Report names in the Report Title column are interactive and link to a view of each report. The Show menu filters the types of reports that are listed. Additionally, interactive column headings can be used to sort the data in each column.

The appliance stores up to 12 instances of each scheduled report (up to 1000 reports). Archived reports are stored in the `/periodic_reports` directory on the appliance. Archived reports are deleted automatically. As new reports are added, older reports are removed to keep the number at 1000. The limit of 12 instances applies to each scheduled report with the same name and time range.

EXPORTING REPORT DATA

Export links on the display pages will export raw data to a comma-separated values (CSV) file, that you can access and manipulate using database applications such as, Microsoft Excel.

The following example is an entry from a raw data export of the Anti-Malware category report, where Pacific Daylight Time (PDT) is displayed as GMT - 7 hours:

```
Begin Timestamp, End Timestamp, Begin Date, End Date, Name,
Transactions Monitored, Transactions Blocked, Transactions Detected
1159772400.0, 1159858799.0, 2006-10-02 07:00 GMT, 2006-10-03 06:59 GMT,
Adware, 525, 2100, 2625
```

Table 20-1 Viewing Raw Data Entries

Category Header	Value	Description
Begin Timestamp	1159772400.0	Query start time in number of seconds from epoch.
End Timestamp	1159858799.0	Query end time in number of seconds from epoch.
Begin Date	2006-10-02 07:00 GMT	Date the query began.
End Date	2006-10-03 06:59 GMT	Date the query ended.
Name	Adware	Name of the malware category.
Transactions Monitored	525	Number of transactions monitored.
Transactions Blocked	2100	Number of transactions blocked.
Transactions Detected	2625	Total number of transactions: Number of transactions detected + Number of transactions blocked.

Note — Category headers are different for each type of report.

Logging

This chapter contains the following information:

- “Logging Overview” on page 442
- “Working with Log Subscriptions” on page 448
- “Access Log File” on page 456
- “W3C Compliant Access Logs” on page 467
- “Custom Formatting in Access Logs and W3C Logs” on page 470
- “Including HTTP/HTTPS Headers in Log Files” on page 479
- “Malware Scanning Verdict Values” on page 480
- “Traffic Monitor Log” on page 482

LOGGING OVERVIEW

You can use log files to monitor web traffic. To configure the appliance to create log files, you create log subscriptions. A log subscription is an appliance configuration that associates a log file type with a name, logging level, and other parameters, such as size and destination information. You can subscribe to a variety of log file types. For more information about log subscriptions, see “Working with Log Subscriptions” on page 448.

In typical appliance monitoring, the appliance administrator usually reads the following log files:

- **Access log.** Records all Web Proxy filtering and scanning activity. For more information about the access log, see “Access Log File” on page 456.
- **Traffic Monitor log.** Records all L4 Traffic Monitor activity. For more information about the traffic monitor log, see “Traffic Monitor Log” on page 482.

The appliance also creates other log file types, such as the system log file. You might want to read other log files to troubleshoot appliance errors. For a list of each type, see “Log File Types” on page 442.

The appliance provides several options for customizing the type of information recorded in the access log. For more information, see “Custom Formatting in Access Logs and W3C Logs” on page 470.

Log File Types

The log file type indicates what information is recorded in the generated log, such as web traffic or system data. By default, the Web Security appliance has log subscriptions for most log file types already created. However, there are some log file types that specific to troubleshooting the Web Proxy. Those logs are not created by default. For more information on those log file types, see “Web Proxy Logging” on page 446.

Table 21-1 lists the Web Security appliance log file types created by default.

Table 21-1 Default Log File Types

Log File Type	Description	Enabled by Default?
Access Control Engine Logs	Records messages related to the Web Proxy ACL (access control list) evaluation engine.	No
Access Logs	Records Web Proxy client history.	Yes
Authentication Framework Logs	Records authentication history and messages.	Yes
CLI Audit Logs	Records a historical audit of command line interface activity.	Yes

Table 21-1 Default Log File Types (Continued)

Log File Type	Description	Enabled by Default?
Configuration Logs	Records messages related to the Web Proxy configuration management system.	No
Connection Management Logs	Records messages related to the Web Proxy connection management system.	No
Data Security Logs	Records client history for upload requests that are evaluated by the IronPort Data Security Filters. For more information on the data security log, see “Logging” on page 254.	Yes
Data Security Module Logs	Records messages related to the IronPort Data Security Filters.	No
DCA Engine Logs (Dynamic Content Analysis)	Records messages related to the Cisco IronPort Web Usage Controls Dynamic Content Analysis engine.	Yes
DCA Engine Framework Logs (Dynamic Content Analysis)	Records messages related to communication between the Web Proxy and the Cisco IronPort Web Usage Controls Dynamic Content Analysis engine.	No
Default Proxy Logs	Records errors related to the Web Proxy. This is the most basic of all Web Proxy related logs. To troubleshoot more specific aspects related to the Web Proxy, create a log subscription for the applicable Web Proxy module. For more information about Web Proxy logging, see “Web Proxy Logging” on page 446.	Yes
Disk Manager Logs	Records Web Proxy messages related to writing to the cache on disk.	No
External Authentication Logs	Records messages related to using the external authentication feature, such as communication success or failure with the external authentication server. Even with external authentication is disabled, this log contains messages about local users successfully or failing logging in. For more information on external authentication, see “Using External Authentication” on page 520.	Yes
Feedback Logs	Records the web users reporting misclassified pages.	Yes

Table 21-1 Default Log File Types (Continued)

Log File Type	Description	Enabled by Default?
FTP Proxy Logs	Records error and warning messages related to the FTP Proxy.	No
GUI Logs (Graphical User Interface)	Records history of page refreshes in the web interface.	Yes
HTTPS Logs	Records Web Proxy messages specific to the HTTPS proxy (when the HTTPS Proxy is enabled).	No
License Module Logs	Records messages related to the Web Proxy's license and feature key handling system.	No
Logging Framework Logs	Records messages related to the Web Proxy's logging system.	No
Logging Logs	Records errors related to log management.	Yes
McAfee Integration Framework Logs	Records messages related to communication between the Web Proxy and the McAfee scanning engine.	No
McAfee Logs	Records the status of anti-malware scanning activity from the McAfee scanning engine.	Yes
Memory Manager Logs	Records Web Proxy messages related to managing all memory including the in-memory cache for the Web Proxy process.	No
Miscellaneous Proxy Modules Logs	Records Web Proxy messages that are mostly used by developers or customer support.	No
NTP Logs (Network Time Protocol)	Records changes to the system time made by the Network Time Protocol.	Yes
PAC File Hosting Daemon Logs	Records proxy auto-config (PAC) file usage by clients.	Yes
Proxy Bypass Logs	Records transactions that bypass the Web Proxy.	Yes
Reporting Logs	Records a history of report generation.	Yes
Reporting Query Logs	Records errors related to report generation.	Yes

Table 21-1 Default Log File Types (Continued)

Log File Type	Description	Enabled by Default?
Request Debug Logs	Records very detailed debug information on a specific HTTP transaction from all Web Proxy module log types. You might want to create this log subscription to troubleshoot a proxy issue with a particular transaction without creating all other proxy log subscriptions. Note: You can create this log subscription in the CLI only.	No
SHD Logs (System Health Daemon)	Records a history of the health of system services and a history of unexpected daemon restarts.	Yes
SNMP Module Logs	Records Web Proxy messages related to interacting with the SNMP monitoring system.	No
Status Logs	Records information related to the system, such as feature key downloads.	Yes
System Logs	Records DNS, error, and commit activity.	Yes
Traffic Monitor Error Logs	Records L4TM interface and capture errors.	Yes
Traffic Monitor Logs	Records sites added to the L4TM block and allow lists.	Yes
Updater Logs	Records a history of WBRS and other updates.	Yes
W3C Logs	Records Web Proxy client history in a W3C compliant format. For more information, see “W3C Compliant Access Logs” on page 467.	No
WBNP Logs (SenderBase Network Participation)	Records a history of SenderBase network participation uploads to the SenderBase network.	Yes
WCCP Module Logs	Records Web Proxy messages related to implementing WCCP.	No
Webcat Integration Framework Logs	Records messages related to communication between the Web Proxy and the configured URL filtering engine, either IronPort URL Filters or Cisco IronPort Web Usage Controls.	No
Web Categorization Logs	Records the status of the IronPort URL Filters service, such as whether or not the service is running.	Yes

Table 21-1 Default Log File Types (Continued)

Log File Type	Description	Enabled by Default?
Webroot Integration Framework Logs	Records messages related to communication between the Web Proxy and the Webroot scanning engine.	No
Webroot Logs	Records the status of anti-malware scanning activity from the Webroot scanning engine.	Yes
Welcome Page Acknowledgement Logs	Records a history of web clients who click the Accept button on the end-user acknowledgement page.	Yes

Web Proxy Logging

By default, the Web Security appliance has one log subscription created for Web Proxy logging messages, the “Default Proxy Logs.” The Web Proxy information stored in this log covers all aspects, or modules, of the Web Proxy. The appliance also includes log file types for each Web Proxy module so you can read more specific debug information for each module without cluttering up the Default Proxy Logs.

If a user or administrator encounters an issue with the Web Proxy behavior, read the Default Proxy Logs first. If you see a log entry that you suspect might be the symptom of an issue, then you can create a log subscription for the relevant specific Web Proxy module. Then read that proxy log to help troubleshoot the problem.

You can create log subscriptions of these proxy module logs in web interface or in the CLI. However, you can only create the Request Debug Logs in the CLI.

The following list includes all Web Proxy module log types:

- Access Control Engine Logs
- Configuration Logs
- Connection Management Logs
- Data Security Module Logs
- DCA Engine Framework Logs
- Disk Manager Logs
- FTP Proxy Logs
- HTTPS Logs
- License Module Logs
- Logging Framework Logs
- McAfee Integration Framework Logs

- Memory Manager Logs
- Miscellaneous Proxy Modules Logs
- Request Debug Logs
- SNMP Module Logs
- WCCP Module Logs
- Webcat Integration Framework Logs
- Webroot Integration Framework Logs

For a description of each log type, see Table 21-1, “Default Log File Types,” on page 442.

WORKING WITH LOG SUBSCRIPTIONS

A log subscription is an appliance configuration that specifies the type of log file to create and other factors, such as the log file name and method of retrieving the log file. Use the System Administration > Log Subscriptions page to configure log file subscriptions.

Figure 21-1 shows the Log Subscriptions page where you work with log subscriptions.

Figure 21-1 Log File Subscriptions

Log Subscriptions

Configured Log Subscriptions				
Add Log Subscription...				
Log Name	Type	Log Files	All Rollover	Delete
accesslogs	Access Logs	ftp://wsa01-vmw1-tpub.qa/accesslogs	<input type="checkbox"/>	
authlogs	Authentication Framework Logs	ftp://wsa01-vmw1-tpub.qa/authlogs	<input type="checkbox"/>	
bypasslogs	Proxy Bypass Logs	ftp://wsa01-vmw1-tpub.qa/bypasslogs	<input type="checkbox"/>	
cli_logs	CLI Audit Logs	ftp://wsa01-vmw1-tpub.qa/cli_logs	<input type="checkbox"/>	
dca_logs	DCA Engine Logs	ftp://wsa01-vmw1-tpub.qa/dca_logs	<input type="checkbox"/>	
external_auth_logs	External Authentication Logs	ftp://wsa01-vmw1-tpub.qa/external_auth_logs	<input type="checkbox"/>	
feedback_logs	Feedback Logs	ftp://wsa01-vmw1-tpub.qa/feedback_logs	<input type="checkbox"/>	
gui_logs	GUI Logs	ftp://wsa01-vmw1-tpub.qa/gui_logs	<input type="checkbox"/>	
idsdataloss_logs	Data Security Logs	ftp://wsa01-vmw1-tpub.qa/idsdataloss_logs	<input type="checkbox"/>	
logderrorlogs	Logging Logs	ftp://wsa01-vmw1-tpub.qa/logderrorlogs	<input type="checkbox"/>	
mcafee_logs	McAfee Logs	ftp://wsa01-vmw1-tpub.qa/mcafee_logs	<input type="checkbox"/>	
pacd_logs	PAC File Hosting Daemon Logs	ftp://wsa01-vmw1-tpub.qa/pacd_logs	<input type="checkbox"/>	
proxylogs	Default Proxy Logs	ftp://wsa01-vmw1-tpub.qa/proxylogs	<input type="checkbox"/>	
reportd_logs	Reporting Logs	ftp://wsa01-vmw1-tpub.qa/reportd_logs	<input type="checkbox"/>	
reportqueryd_logs	Reporting Query Logs	ftp://wsa01-vmw1-tpub.qa/reportqueryd_logs	<input type="checkbox"/>	
shd_logs	SHD Logs	ftp://wsa01-vmw1-tpub.qa/shd_logs	<input type="checkbox"/>	
sntpd_logs	NTP Logs	ftp://wsa01-vmw1-tpub.qa/sntpd_logs	<input type="checkbox"/>	
status	Status Logs	ftp://wsa01-vmw1-tpub.qa/status	<input type="checkbox"/>	
system_logs	System Logs	ftp://wsa01-vmw1-tpub.qa/system_logs	<input type="checkbox"/>	
trafmon_errlogs	Traffic Monitor Error Logs	ftp://wsa01-vmw1-tpub.qa/trafmon_errlogs	<input type="checkbox"/>	
trafmonlogs	Traffic Monitor Logs	ftp://wsa01-vmw1-tpub.qa/trafmonlogs	<input type="checkbox"/>	
updater_logs	Updater Logs	ftp://wsa01-vmw1-tpub.qa/updater_logs	<input type="checkbox"/>	
wbnp_logs	WBNP Logs	ftp://wsa01-vmw1-tpub.qa/wbnp_logs	<input type="checkbox"/>	
webcat_logs	Web Categorization Logs	ftp://wsa01-vmw1-tpub.qa/webcat_logs	<input type="checkbox"/>	
webrootlogs	Webroot Logs	ftp://wsa01-vmw1-tpub.qa/webrootlogs	<input type="checkbox"/>	
welcomeack_logs	Welcome Page Acknowledgement Logs	ftp://wsa01-vmw1-tpub.qa/welcomeack_logs	<input type="checkbox"/>	

By default, the appliance is configured with one log subscription for most log types. You can add, edit, or delete log subscriptions. You can retrieve log files from the appliance using SCP, FTP, or Syslog. You can create multiple log subscriptions for each type of log file.

The appliance includes more options when configuring the access log:

- **Include additional information in each log entry.** For more information about customizing the access log, see “Custom Formatting in Access Logs and W3C Logs” on page 470.
- **Choose the format of the information.** You can choose among the following format options:

- Apache
- Squid
- Squid Details
- **Exclude entries based on HTTP status codes.** You can configure the access log to not include transactions based on particular HTTP status codes to filter out certain transactions. For example, you might want to filter out authentication failure requests that have codes of 407 or 401.

Log File Name and Appliance Directory Structure

The appliance creates a directory for each log subscription based on the log subscription name. The name of the log file in the directory is composed of the following information:

- Log file name specified in the log subscription
- Timestamp when the log file was started
- A single-character status code, either `.c` (signifying current) or `.s` (signifying saved)

The filename of logs are made using the following formula:

```
/LogSubscriptionName/LogFilename.@timestamp.statuscode
```

Note — You should only transfer log files with the saved status.

Rolling Over Log Subscriptions

AsyncOS rolls over log subscriptions based on settings you make in each log subscription. Rolling over a log subscription is an AsyncOS process that accomplishes the following tasks:

- Creates a new log file with the timestamp of the rollover and designates the file as current with the letter “c” extension.
- Renames the current log file to have a letter “s” extension signifying saved.
- Transfers the newly saved log file to a remote host when the log retrieval method is push-based. For a list of the log retrieval methods, see Table 21-4 on page 453.
- Transfers any previously unsuccessful log files from the same subscription when the log retrieval method is push-based.
- Deletes the oldest file in the log subscription if the total number of files to keep on hand has been exceeded when the log retrieval method is poll-based.

AsyncOS rolls over log subscriptions in the following ways:

- **Manually.** The appliance administrator can manually roll over log subscriptions on demand from either the web interface or the CLI. Use the **Rollover Now** button on the System Administration > Log Subscriptions page, or the `rollovernow` CLI command. The `rollovernow` command allows you to roll over all log files at once or select a specific log file from a list.

- **Automatically.** AsyncOS rolls over log subscriptions based on the first user-specified limit reached: maximum file size or maximum time. Log subscriptions based on the FTP poll retrieval method create files and store them in the FTP directory on the appliance until they are retrieved from a remote FTP client, or until the system needs to create more space for log files.

To roll over a log subscription in the web interface:

1. Navigate to the System Administration > Log Subscriptions page.
2. Click the check box under the Rollover column for each log subscription you want to roll over.
3. Click **Rollover Now**.

Working with Compressed Log Files

To save disk space on the Web Security appliance, log subscriptions can compress rolled over log files before storing them on the disk. Only rolled over logs are compressed. The current active log file is not compressed.

Each log subscription has its own log compression setting, so you can choose which log subscriptions to compress. AsyncOS compresses log files using the gzip compression format.

Viewing the Most Recent Log Files

You can view a the most recent version of a log file from the following locations:

- **Web interface.** On the System Administration > Log Subscriptions page, click the name of the log subscription in the Log Files column of the list of log subscriptions. When you click the link to the log subscription, AsyncOS prompts you to enter your password. Then it lists the available log files for that subscription. Click one of the log files to view it in your browser or to save it to disk.
- **Command line interface.** Use the `tail` CLI command. AsyncOS displays the configured log subscriptions and prompts you to select the log subscription to view. Use `Ctrl+C` to exit from the `tail` command at any time.

Note — If a log subscription is compressed, you must download it before you can uncompress and open it.

Configuring Host Keys

Use the `logconfig -> hostkeyconfig` subcommand to manage host keys for use with SSH when pushing log files to other servers from the Web Security appliance. SSH servers must have a pair of host keys, one private and one public. The private host key resides on the SSH server and cannot be read by remote machines. The public host key is distributed to any client machine that needs to interact with the SSH server.

The `hostkeyconfig` subcommand performs the following functions:

Table 21-2 Managing Host Keys—List of Subcommands

Command	Description
New	Add a new key.
Scan	Automatically download a host key.
Host	Display system host keys. This is the value to place in the remote system's 'known_hosts' file.
Fingerprint	Display system host key fingerprints.
User	Displays the public key of the system account that pushes the logs to the remote machine. This is the same key that is displayed when setting up an SCP push subscription. This is the value to place in the remote system's 'authorized_keys' file.

Adding and Editing Log Subscriptions

To add or edit a log subscription:

1. Navigate to the System Administration > Log Subscriptions page.
2. To add a log subscription, click **Add Log Subscription**. Or, to edit a log subscription, click the name of the log file in the Log Name field.

The New Log Subscription page or Edit Log Subscription page appears.

3. Select the type of log to associate with this subscription from the Log Type field.
4. Enter a name for the log subscription in the Log Name field.

The appliance uses this name for the directory on the appliance that will contain the log file.

5. If you are creating an access log, configure the following options:

Access Log Option	Description
Log Style	Choose the log format to use, either Squid, Apache, or Squid Details.
Custom Fields	Optionally, enter the other type of information to include in each access log entry. For more information, see "Custom Formatting in Access Logs and W3C Logs" on page 470.

6. If you are creating a W3C access log, configure the following options:

Access Log Option	Description
Log Fields	<p>Choose the fields you want to include in the W3C access log. Select a field in the Available Fields list, or type a field in the Custom Field box, and click Add. The order the fields appear in the Selected Log Fields list determines the order of fields in the W3C access log file. You can change the order of fields using the Move Up and Move Down buttons. You can remove a field by selecting it in the Selected Log Fields list and clicking Remove.</p> <p>You can enter multiple user defined fields in the Custom Fields box and add them simultaneously as long as each entry is separated by a new line (click Enter) before clicking Add.</p> <p>For more information, see “W3C Compliant Access Logs” on page 467.</p>

Note — When you change the log fields included in a W3C log subscription, the log subscription automatically rolls over. This allows the latest version of the log file to include the correct new field headers.

7. Enter a name for the log file in the File Name field.
8. Enter the maximum file size in bytes the log file can be in the Maximum File Size field. After the number, enter “G” to specify Gigabytes, “M” for Megabytes, or “K” for Kilobytes.
9. Choose whether or not to compress log files after they have been rolled over using the Log Compression field.

For more information, see “Working with Compressed Log Files” on page 450.

10. If you are creating an access log or a W3C access log, you can optionally choose to exclude certain transactions based on particular HTTP status codes in the Log Exclusions field. For example, you might want to filter out authentication failure requests that have codes of 407 or 401.
11. Choose the amount of detail to include in the log file in the Log Level field.

The Log Level field does not appear for access and W3C access logs subscriptions

More detailed settings create larger log files and have a greater impact on system performance. More detailed settings include all the messages contained in less detailed settings, plus additional messages. As the level of detail increases, system performance decreases.

Table 21-3 describes the levels of detail you can choose in the Log Level field.

Table 21-3 Logging Levels

Log Level	Description
Critical	This is the least detailed setting. This level only includes errors. Using this setting will not allow you to monitor performance and other important activities. However, the log files will not reach their maximum size as quickly. This log level is equivalent to the syslog level "Alert."
Warning	This level includes all errors and warnings created by the system. Using this setting will not allow you to monitor performance and other important activities. This log level is equivalent to the syslog level "Warning."
Information	This level includes the detailed system operations. This is the default. This log level is equivalent to the syslog level "Info."
Debug	This level includes data useful for debugging system problems. Use the Debug log level when you are trying to discover the cause of an error. Use this setting temporarily, and then return to the default level. This log level is equivalent to the syslog level "Debug."
Trace	This is the most detailed setting. This level includes a complete record of system operations and activity. The Trace log level is recommended only for developers. Using this level causes a serious degradation of system performance and is not recommended. This log level is equivalent to the syslog level "Debug."

12. Choose how to retrieve the log file from the appliance in the Retrieval Method field.

Table 21-4 describes the different ways you can retrieve log files:

Table 21-4 Log Transfer Protocols

Retrieval Method	Description
FTP on Appliance (FTP Poll)	This method requires a remote FTP client accessing the appliance to retrieve log files using an admin or operator user's username and password. When you choose this method, you must enter the maximum number of log files to store on the appliance. When the maximum number is reached, the system deletes the oldest file. This is the default.

Table 21-4 Log Transfer Protocols (Continued)

Retrieval Method	Description
FTP on Remote Server (FTP Push)	<p>This method periodically pushes log files to an FTP server on a remote computer.</p> <p>When you choose this method, you must enter the following information:</p> <ul style="list-style-type: none"> • Maximum time between file transfers • FTP server host name • Directory on FTP server to store the log file • Username and password of a user that has permission to connect to the FTP server <p>Note: AsyncOS for Web only supports passive mode for remote FTP servers. It cannot push log files to an FTP server in active mode.</p>
SCP on Remote Server (SCP Push)	<p>This method periodically pushes log files using the secure copy protocol to an SCP server on a remote computer. This method requires an SSH SCP server on a remote computer using the SSH1 or SSH2 protocol. The subscription requires a user name, SSH key, and destination directory on the remote computer. Log files are transferred based on a rollover schedule set by you.</p> <p>When you choose this method, you must enter the following information:</p> <ul style="list-style-type: none"> • Maximum time between file transfers • Protocol to use for transmission, either SSH1 or SSH2 • SCP server host name • Directory on SCP server to store the log file • Username of a user that has permission to connect to the SCP server <p>Choose whether or not to enable host key checking.</p>
Syslog Push	<p>This method sends log messages to a remote syslog server. This method conforms to RFC 3164. The appliance uses port 514.</p> <p>When you choose this method, you must enter the following information:</p> <ul style="list-style-type: none"> • Syslog server host name • Protocol to use for transmission, either UDP or TCP • Facility to use with the log <p>You can only choose syslog for text-based logs.</p>

13. Submit and commit your changes.

14. If you chose SCP as the retrieval method, the appliance displays an SSH key to you must place on the SCP server host.

Deleting a Log Subscription

To delete a log subscription:

1. Navigate to the System Administration > Log Subscriptions page.
2. Click the icon under the Delete column for the log subscription you want to delete.
3. Submit and commit your changes.

Table 21-5 Access Log File Entry (Continued)

Field Value	Field Description
DIRECT/my.website.com	<p>Code that describes which server was contacted for the retrieving the request content.</p> <p>Most common values include:</p> <ul style="list-style-type: none"> • NONE. The Web Proxy had the content, so it did not contact any other server to retrieve the content. • DIRECT. The Web Proxy went to the server named in the request to get the content. • DEFAULT_PARENT. The Web Proxy went to its primary parent proxy or an external DLP server to get the content.
text/plain	Response body MIME type.
ALLOW_WBRS	<p>ACL decision tag.</p> <p>For more information, see “ACL Decision Tags” on page 459.</p>
AccessOrDecryptionPolicyGroup	<p>Access Policy or Decryption Policy group name. When the transaction matches the global Access Policy or global Decryption Policy, this value is “DefaultGroup.”</p> <p>Any space in the policy group name is replaced with an underscore (_).</p>
IdentityPolicyGroup	<p>Identity policy group name.</p> <p>Any space in the policy group name is replaced with an underscore (_).</p>
DataSecurityPolicyGroup	<p>IronPort Data Security Policy group name. When the transaction matches the global IronPort Data Security Policy, this value is “DefaultGroup.” This policy group name only appears when IronPort Data Security Filters is enabled. “NONE” appears when no Data Security Policy was applied.</p> <p>Any space in the policy group name is replaced with an underscore (_).</p>
ExternalDLPPolicyGroup	<p>External DLP Policy group name. When the transaction matches the global External DLP Policy, this value is “DefaultGroup.” “NONE” appears when no External DLP Policy was applied.</p> <p>Any space in the policy group name is replaced with an underscore (_).</p>

Table 21-6 Transaction Result Codes (Continued)

Result Code	Description
TCP_CLIENT_REFRESH_MISS	The client sent a “don’t fetch response from cache” request by issuing the ‘Pragma: no-cache’ header. Due to this header from the client, the appliance fetched the object from the origin server.
TCP_DENIED	The client request was denied due to Access Policies.
NONE	There was an error in the transaction. For example, a DNS failure or gateway timeout.
FTP_HIT	The object requested was fetched from the disk cache. This is used for native FTP transactions only.
FTP_MEM_HIT	The object requested was fetched from the memory cache. This is used for native FTP transactions only.
FTP_MISS	The object was not found in the cache, so it was fetched from the origin server. This is used for native FTP transactions only.
FTP_REFRESH_HIT	The object was in the cache, but had expired. The proxy fetched the object from the origin server. This is used for native FTP transactions only.
FTP_DENIED	The client request was denied due to Access Policies. This is used for native FTP transactions only.

ACL Decision Tags

An ACL decision tag is a field in an access log entry that indicates how the Web Proxy handled the transaction. It includes information from the Web Reputation filters, URL categories, and the scanning engines.

Table 21-7 describes the ACL decision tag values.

Table 21-7 ACL Decision Tag Values

ACL Decision Tag	Description
ALLOW_ADMIN	The Web Proxy allowed the transaction based on Applications settings for the Access Policy group.
ALLOW_ADMIN_ERROR_PAGE	The Web Proxy allowed the transaction to an IronPort notification page and to any logo used on that page.
ALLOW_WBRS	The Web Proxy allowed the transaction based on the Web Reputation filter settings for the Access Policy group.

Table 21-7 ACL Decision Tag Values (Continued)

ACL Decision Tag	Description
BLOCK_ADMIN	The Web Proxy blocked the transaction based on Applications or Objects settings for the Access Policy group.
BLOCK_ADMIN_CONNECT	The Web Proxy blocked the transaction based on the TCP port of the destination as defined in the HTTP CONNECT Ports setting for the Access Policy group.
BLOCK_ADMIN_CUSTOM_USER_AGENT	The Web Proxy blocked the transaction based on the user agent as defined in the Block Custom User Agents setting for the Access Policy group.
BLOCK_ADMIN_DLP	The Web Proxy blocked the transaction based on the MIME type of the request body content as defined in the Data Security Policy group.
BLOCK_ADMIN_FILE_TYPE	The Web Proxy blocked the transaction based on the file type as defined in the Access Policy group.
BLOCK_ADMIN_PROTOCOL	The Web Proxy blocked the transaction based on the protocol as defined in the Block Protocols setting for the Access Policy group.
BLOCK_ADMIN_SIZE	The Web Proxy blocked the transaction based on the size of the response as defined in the Object Size settings for the Access Policy group.
BLOCK_ADMIN_SIZE_DLP	The Web Proxy blocked the transaction based on the size of the request body content as defined in the Data Security Policy group.
BLOCK_AMW_REQ	The Web Proxy suspects the URL in the HTTP request might not be safe, so it blocked the transaction at request time based on the Anti-Malware settings for the Access Policy group.
BLOCK_AMW_RESP	The Web Proxy blocked the response based on the Anti-Malware settings for the Access Policy group.
BLOCK_CONTINUE_WEBCAT	The Web Proxy blocked the transaction and displayed the Warn and Continue page based on a URL category in the Access Policy group configured to "Warn."
BLOCK_ICAP	The Web Proxy blocked the request based on the verdict of the external DLP system as defined in the External DLP Policy group.

Table 21-7 ACL Decision Tag Values (Continued)

ACL Decision Tag	Description
BLOCK_SUSPECT_USER_AGENT	The Web Proxy blocked the transaction based on the Suspect User Agent setting for the Access Policy group.
BLOCK_WBRS	The Web Proxy blocked the transaction based on the Web Reputation filter settings for the Access Policy group.
BLOCK_WBRS_DLP	The Web Proxy blocked the upload request based on the Web Reputation filter settings for the Data Security Policy group.
BLOCK_WEBCAT	The Web Proxy blocked the transaction based on URL category filtering settings for the Access Policy group.
BLOCK_WEBCAT_DLP	The Web Proxy blocked the upload request based on the URL category filtering settings for the Data Security Policy group.
DEFAULT_CASE	The Web Proxy allowed the client to access the server because none of the AsyncOS services, such as Web Reputation or anti-malware scanning, took any action on the transaction.
MONITOR_AMW_REQ	The Web Proxy suspects the URL in the HTTP request might not be safe, but it monitored the transaction based on the Anti-Malware settings for the Access Policy group.
MONITOR_AMW_RESP	The Web Proxy monitored the server response based on the Anti-Malware settings for the Access Policy group.
MONITOR_DLP	The Web Proxy scanned the upload request using either a Data Security Policy or an External DLP Policy, but did not block the request. It evaluated the request against the Access Policies.
MONITOR_SUSPECT_USER_AGENT	The Web Proxy monitored the transaction based on the Suspect User Agent setting for the Access Policy group.
MONITOR_WBRS	The Web Proxy monitored the transaction based on the Web Reputation filter settings for the Access Policy group.
NO_PASSWORD	The user failed authentication.

Table 21-7 ACL Decision Tag Values (Continued)

ACL Decision Tag	Description
OTHER	The Web Proxy did not complete the request due to an error, such as an authorization failure, server disconnect, or an abort from the client.

Understanding Web Reputation and Anti-Malware Information

The access log file entries aggregate and display the results of Web Reputation filtering and anti-malware scanning. The appliance displays this information in angled brackets at the end of each access log entry.

The following text is the Web Reputation filtering and anti-malware scanning information from an access log file entry. In this example, the Webroot scanning engine found the malware:

```
<IW_adv,ns,13,"Comedy-Planet",- ,2116,363786,-,-,-,-,-,0,0,IW_adv,->
```

The following text is the Web Reputation filtering and anti-malware scanning information from an access log file entry. In this example, the McAfee scanning engine found the malware:

```
<IW_adv,ns,0,-,-,-,-,23,"CP22.EXE",0,1,1,"Generic Downloader.ab",0,0,nc,IW_adv>
```

Note — For an example of a whole access log file entry, see “Access Log File” on page 456.

Table 21-8 describes the different fields in the Web Reputation filtering and anti-malware scanning section of each access log file entry.

Table 21-8 Access Log File Entry — Web Reputation and Anti-Malware Information

Field Value Example 1	Field Value Example 2	Description
IW_adv	IW_adv	The URL category assigned to the transaction, abbreviated. For a list of URL category abbreviations, see “URL Category Descriptions” on page 313.
ns	ns	Web Reputation filters score. This field either shows the score as a number, “ns” for “no score,” or “dns” when there is a DNS lookup error.

Table 21-8 Access Log File Entry — Web Reputation and Anti-Malware Information (Continued)

Field Value Example 1	Field Value Example 2	Description
13	0	The malware scanning verdict Webroot passed to the DVS engine. Applies to responses detected by Webroot only. For more information, see “Malware Scanning Verdict Values” on page 480.
Comedy-Planet	-	Name of the spyware that is associated with the object. Applies to responses detected by Webroot only.
-	-	The Webroot specific value associated with the Threat Risk Threshold (TRT) value that determines the probability that malware exists. Applies to responses detected by Webroot only.
2166	-	A value that Webroot uses as a threat identifier. IronPort Customer Support may use this value when troubleshooting an issue. Applies to responses detected by Webroot only.
363786	-	A value that Webroot uses as a trace identifier. IronPort Customer Support may use this value when troubleshooting an issue. Applies to responses detected by Webroot only.
-	23	The malware scanning verdict McAfee passed to the DVS engine. Applies to responses detected by McAfee only. For more information, see “Malware Scanning Verdict Values” on page 480.
-	CP22.EXE	The name of the file McAfee scanned. Applies to responses detected by McAfee only.
-	0	A value that McAfee uses as a scan error. IronPort Customer Support may use this value when troubleshooting an issue. Applies to responses detected by McAfee only.
-	1	A value that McAfee uses as a detection type. IronPort Customer Support may use this value when troubleshooting an issue. Applies to responses detected by McAfee only.

Table 21-8 Access Log File Entry — Web Reputation and Anti-Malware Information (Continued)

Field Value Example 1	Field Value Example 2	Description
-	1	A value that McAfee uses as a virus type. IronPort Customer Support may use this value when troubleshooting an issue. Applies to responses detected by McAfee only.
-	Generic Downloader.ab	The name of the virus that McAfee scanned. Applies to responses detected by McAfee only.
0	0	The IronPort Data Security scan verdict based on the action in the Content column of the IronPort Data Security Policy. The following list describes the possible values for this field: <ul style="list-style-type: none"> • 0. Allow • 1. Block • - (hyphen). No scanning was initiated by the IronPort Data Security Filters. This value appears when the IronPort Data Security Filters is disabled or when the URL category action is set to Allow.
0	0	The External DLP scan verdict based on the result given in the ICAP response. The following list describes the possible values for this field: <ul style="list-style-type: none"> • 0. Allow • 1. Block • - (hyphen). No scanning was initiated by the external DLP server. This value appears when External DLP scanning is disabled or when the content was not scanned due to an exempt URL category on the External DLP Policies > Destinations page.
IW_adv	nc	The URL category verdict determined during request-side scanning, abbreviated. Applies to both IronPort URL Filters and Cisco IronPort Web Usage Controls URL filtering engines. This field lists a hyphen (-) when URL filtering is disabled. For a list of URL category abbreviations, see “URL Category Descriptions” on page 313.

Table 21-8 Access Log File Entry — Web Reputation and Anti-Malware Information (Continued)

Field Value Example 1	Field Value Example 2	Description
-	IW_adv	<p>The URL category verdict determined during response-side scanning, abbreviated. Applies to the Cisco IronPort Web Usage Controls URL filtering engine only. Only applies when the Dynamic Content Analysis engine is enabled and when no category is assigned at request time (a value of "nc" is listed in the request-side scanning verdict).</p> <p>For a list of URL category abbreviations, see "URL Category Descriptions" on page 313.</p>

Web Reputation Filters Example

In the following example, the URL request was allowed because the URL's Web Reputation score was high enough to qualify to be allowed without being scanned for malware.

```
172.xx.xx.xx TCP_MISS/302 656 GET http://my.website.com/ - DIRECT/
my.website.com text/plain ALLOW_WBRS-MyAccessPolicy-MyIdentity-NONE-
NONE-DefaultRouting <CTGY,6.0,-,-,-,-,-,-,-,-,-,-,-,-,-,-,-,0,0,CTGY,->
```

In this example, "6.0" is the Web Reputation score. The hyphen "-" values indicate the request was not forwarded to the DVS engine for anti-malware scanning. The ACL decision tag "ALLOW_WBRS" indicates that the request was allowed, and therefore not forwarded for anti-malware scanning, based on this Web Reputation score.

Anti-Malware Request Example

In the following example, the Webroot scanning engine scanned the URL request and assigned a malware scanning verdict based on the URL request. Webroot is the only scanning engine that scans a URL request. For more information about Webroot scanning, see "Webroot Scanning" on page 345.

```
1160078708.895 199 172.xx.xx.xx TCP_DENIED/403 1996 GET http://
www.website.com/path/ - NONE/- - BLOCK_AMW_REQ-MyAccessPolicy-
MyIdentity-NONE-NONE-DefaultRouting <nc,ns,10,"Malware",100,-,-,-,-,-
,-,-,-,-,0,0,nc,->
```

In this example, the "nc" stands for "no category" because AsyncOS did not match the URL request to a matching category. The "ns" stands for "no score" because AsyncOS did not find any Web Reputation information about this URL request. Because it did not find any Web Reputation information about the URL, it passed the request to the DVS engine for anti-malware scanning.

The “10” value is the malware scanning verdict that Webroot passes to the DVS engine. (“10” corresponds to generic spyware, as explained in Table 21-13 on page 480.) The “BLOCK_AMW_REQ” ACL decision tag shows that Webroot’s request-side checking of the URL produced this verdict. The remainder of the fields show the spyware name (“Malware”), threat risk rating (“100”), threat ID (“-”), and trace ID (“-”) values, which Webroot derived from its evaluation. In this case, the threat ID and trace ID values are empty (“-”) because Webroot did not actually scan a response. All of the McAfee-related values are empty (“-”) because the McAfee scanning engine did not scan the URL request.

Anti-Malware Response Example

In the following example, the McAfee scanning engine scanned the server response, assigned a malware scanning verdict based on the server response, and blocked it from the user.

```
1186606394.787 198 172.xx.xx.xx TCP_DENIED/403 1843 GET http://  
www.eicar.org/download/eicar.com HTTP/1.1 - NONE/- text/plain  
BLOCK_AMW_RESP-MyAccessPolicy-MyIdentity-NONE-NONE-DefaultRouting  
<Comp,3.0,0,-,-,-,-,27,-,0,1,6,"EICAR test file",0,0,Comp,->
```

The following list explains the values in this access log entry that show that this transaction was blocked based on the result of the McAfee scanning engine:

- **TCP_DENIED.** The website was denied due to Access Policies.
- **BLOCK_AMW_RESP-MyAccessPolicy.** This transaction matched the “MyAccessPolicy” Access Policy group, and the due to the settings defined in that policy group, the server response was blocked due to detected malware.
- **3.0 in the angled brackets.** The URL received a Web Reputation Score of 3.0, which fell in the score range to scan further.
- **27 in the angled brackets.** The malware scanning verdict McAfee passed to the DVS engine. 27 corresponds to a virus.
- **“EICAR test file”.** The name of the virus that McAfee scanned.

W3C COMPLIANT ACCESS LOGS

The Web Security appliance provides two different log types for recording Web Proxy transaction information, the access logs and the W3C access logs. The W3C access logs are W3C compliant, and record transaction history in the W3C Extended Log File (ELF) Format.

You can create multiple W3C access log subscriptions and define the data to include in each. You might want to create one W3C access log that includes all information your organization typically needs, and other, specialized W3C access logs that can be used for troubleshooting purposes or special analysis. For example, you might want to create a W3C access log for an HR manager that only needs access to certain information.

Consider the following rules and guidelines when working with W3C access logs:

- You define what data is recorded in each W3C access log subscription.
- The W3C logs are self-describing. The file format (list of fields) is defined in a header at the start of each log file.
- Fields in the W3C access logs are separated by a white space.
- If a field contains no data for a particular entry, a hyphen (-) is included in the log file instead.
- Each line in the W3C access log file relates to one transaction, and each line is terminated by a LF sequence.
- When defining a W3C access log subscription, you can choose from a list of predefined log fields or enter a custom log field. For more information, see “Working with Log Fields in W3C Access Logs” on page 468.
- If you want to use a third party log analyzer tool to read and parse the W3C access logs, you might need to include the “timestamp” field. The timestamp W3C field displays time since the UNIX epoch, and most log analyzers only understand time in this format.
- If you want to copy the log fields included in a W3C access log in their order, use the `logconfig > edit` CLI command. The CLI displays the log fields in order, from which you can copy and then paste them into a separate Web Security appliance web interface.

W3C Log File Headers

Each W3C log file contains header text at the beginning of the file. Each line starts with the # character and provides information about the Web Security appliance that created the log file. The W3C log file headers also include the file format (list of fields), making the log file self-describing.

Table 21-9 describes the header fields listed at the beginning of each W3C log file.

Table 21-9 W3C Log File Header Fields

Header Field	Description
Version	The version of the W3C ELF format used.
Date	The date and time at which the entry was added.
System	The Web Security appliance that generated the log file in the format "Management_IP - Management_hostname."
Software	The Software which generated these logs
Fields	The fields recorded in the log

For example, a W3C log file might contain the following header information:

```
#Version: 1.0
#Date: 2009-06-15 13:55:20
#System: 10.1.1.1 - wsa.qa
#Software: AsyncOS for Web 6.3.0
#Fields: timestamp x-elapsed-time c-ip x-resultcode-httpstatus sc-bytes
cs-method cs-url cs-username x-hierarchy-origin cs-mime-type x-acltag
x-result-code x-suspect-user-agent
```

Working with Log Fields in W3C Access Logs

When defining a W3C access log subscription, you must choose which log fields to include, such as the ACL decision tag or the client IP address. You can include one of the following types of log fields:

- **Predefined.** The web interface includes a list of fields from which you can choose. For more information, see "Custom Formatting in Access Logs and W3C Logs" on page 470.
- **User defined.** You can type a log field that is not included in the predefined list. For more information, see "Including HTTP/HTTPS Headers in Log Files" on page 479.

Most W3C log field names include a prefix that identifies from which header a value comes, such as the client or server. Log fields without a prefix reference values that are independent

of the computers involved in the transaction. Table 21-10 on page 469 describes the W3C log fields prefixes.

Table 21-10 W3C Log Field Prefixes

Prefix Header	Description
c	Client
s	Server
cs	Client to server
sc	Server to client
x	Application specific identifier.

For example, the W3C log field “cs-method” refers to the method in the request sent by the client to the server, and “c-ip” refers to the client’s IP address.

CUSTOM FORMATTING IN ACCESS LOGS AND W3C LOGS

You can customize access logs and W3C access logs to include many different fields to capture comprehensive information about web traffic within the network. Access logs use format specifiers, and the W3C access logs use W3C log fields.

Table 21-11 describes the W3C log fields you can include in the W3C access logs and the custom format specifiers (for the access logs) they correspond with.

Table 21-11 Log Fields in W3C Logs and Format Specifiers in Access Logs

W3C Log Field	Format Specifier in Access Logs	Description
bytes	%B	Total bytes used (request size + response size, which is %b + %q)
c-ip	%a	Client IP Address
CMF	%M	Cache miss flags, CMF flags
cs(Cookie)	%C	Cookie header. This field is written with double-quotes in the access logs.
cs(Host)	%<Host:	Host
cs-mime-type	%c	Response body MIME type. This field is written with double-quotes in the access logs.
cs(Referer)	%<Referrer:	Referrer
cs(User-Agent)	%u	User agent. This field is written with double-quotes in the access logs.
cs(X-Forwarded-For)	%f	X-Forwarded-For header
cs-auth-group	%g	Authorized group names. This field is written with double-quotes in the access logs.
cs-bytes	%q	Request body size
cs-method	%y	Method
N/A	%r	Request first line - request method, URI, HTTP version
cs-uri	%U	Request URI
cs-url	%Y	The entire URL

Table 21-11 Log Fields in W3C Logs and Format Specifiers in Access Logs (Continued)

W3C Log Field	Format Specifier in Access Logs	Description
cs-username	%A	Authenticated user name. This field is written with double-quotes in the access logs.
cs-version	%P	Protocol, including the version number when applicable
date	%v	Date in YYYY-MM-DD
DCF	%j	Do not cache response code; DCF flags
sc(Server)	%>Server:	Server header in the response
sc-body-size	%s	Bytes sent to the client from the Web Proxy for the body content.
sc-bytes	%b	Response body size
sc-http-status	%h	HTTP response code
s-computerName	%N	Server name or destination host name. This field is written with double-quotes in the access logs.
sc-result-code	%w	Result code For example: TCP_MISS, TCP_HIT
sc-result-code-denial	%W	Result code denial
s-hierarchy	%H	Hierarchy retrieval
s-hostname	%d	Data source or server IP address
s-ip	%k	Data source IP address (server IP address)
s-port	%p	Destination port number
time	%V	Time in HH:MM:SS
timestamp	%t	Timestamp in UNIX epoch Note: If you want to use a third party log analyzer tool to read and parse the W3C access logs, you might need to include the "timestamp" field. Most log analyzers only understand time in the format provided by this field.

Table 21-11 Log Fields in W3C Logs and Format Specifiers in Access Logs (Continued)

W3C Log Field	Format Specifier in Access Logs	Description
	%XI	IronPort Data Security Policy scanning verdict. If this field is included, it will display the IDS verdict, or "0" if IDS was active but the document scanned clean, or "-" if no IDS policy was active for the request.
	%Xp	External DLP server scanning verdict
x-acltag	%D	ACL decision tag
x-dvs-threat-name	%X1	DVS threat name. This field is written with double-quotes in the access logs.
x-dvs-scanverdict	%X0	DVS Scan Verdict
x-elapsed-time	%e	Elapsed time
x-error-code	%E	Error type
x-hierarchy-origin	%H/%d	Code that describes which server was contacted for the retrieving the request content. (e.g. DIRECT/www.example.com)
x-latency	%x	Latency
x-local_time	%L	Request local time in human readable format: DD/MMM/YYYY : hh:mm:ss +nnnn. This field is written with double-quotes in the access logs.
x-mcafee-av-detecttype	%Xg	McAfee specific identifier: (detect type)
x-mcafee-av-scanerror	%Xf	McAfee specific identifier: (scan error)
x-mcafee-av-virustype	%Xh	McAfee specific identifier: (virus type)
x-mcafee-filename	%Xe	McAfee specific identifier: (File name yielding verdict) This field is written with double-quotes in the access logs.
x-mcafee-scanverdict	%Xd	McAfee specific identifier: (scan verdict)
x-mcafee-virus-name	%Xj	McAfee specific identifier: (virus name) This field is written with double-quotes in the access logs.

Table 21-11 Log Fields in W3C Logs and Format Specifiers in Access Logs (Continued)

W3C Log Field	Format Specifier in Access Logs	Description
x-result-code	%Xr	Result code
x-resultcode-httpstatus	%w/%h	Result code and the HTTP response code, with a slash (/) in between
x-suspect-user-agent	%%?BLOCK_SUSPECT_USER_AGENT, MONITOR_SUSPECT?%<User-Agent:!!%-%.	Suspect user agent, if applicable. If the Web Proxy determines the user agent is suspect, it will log the user agent in this field. Otherwise, it logs a hyphen. This field is written with double-quotes in the access logs.
x-transaction-id	%l	Transaction ID
x-wbrs-score	%XW	Decoded WBRS score <-10.0-10.0>
N/A	%Xw	Raw numeric WBRS score
N/A	%Xc	URL category code (numeric) of the URL category assigned to the transaction. Applies to both IronPort URL Filters and Cisco IronPort Web Usage Controls URL filtering engines.
x-webcat-code-abbr	%XC	URL category abbreviation for the URL category assigned to the transaction. Applies to both IronPort URL Filters and Cisco IronPort Web Usage Controls URL filtering engines.
x-webcat-code-full	%XF	Full name of the URL category assigned to the transaction. This field is written with double-quotes in the access logs. Applies to both IronPort URL Filters and Cisco IronPort Web Usage Controls URL filtering engines.
N/A	%Xq	The URL category code (numeric) determined during request-side scanning. Applies to both IronPort URL Filters and Cisco IronPort Web Usage Controls URL filtering engines.

Table 21-11 Log Fields in W3C Logs and Format Specifiers in Access Logs (Continued)

W3C Log Field	Format Specifier in Access Logs	Description
x-webcat-req-code-abbr	%XQ	The URL category verdict determined during request-side scanning, abbreviated. Applies to both IronPort URL Filters and Cisco IronPort Web Usage Controls URL filtering engines.
x-webcat-req-code-full	%XR	The URL category verdict determined during request-side scanning, full name. Applies to both IronPort URL Filters and Cisco IronPort Web Usage Controls URL filtering engines.
N/A	%Xa	The URL category code (numeric) determined during response-side scanning. Applies to the Cisco IronPort Web Usage Controls URL filtering engine only.
x-webcat-resp-code-abbr	%XA	The URL category verdict determined during response-side scanning, abbreviated. Applies to the Cisco IronPort Web Usage Controls URL filtering engine only.
x-webcat-resp-code-full	%XL	The URL category verdict determined during response-side scanning, full name. Applies to the Cisco IronPort Web Usage Controls URL filtering engine only.
x-webroot-scanverdict	%Xv	Malware scanning verdict from Webroot
x-webroot-spyid	%Xs	Webroot specific identifier: (Spy ID)
x-webroot-threat-name	%Xn	Webroot specific identifier: (Threat name) This field is written with double-quotes in the access logs.
x-webroot-trace-id	%Xi	Webroot specific scan identifier: (Trace ID)
x-webroot-trr	%Xt	Webroot specific identifier: (Threat Risk Ratio (TRR))
N/A	%:<a	Wait-time to receive the response from the Web Proxy authentication process, after the Web Proxy sent the request.
N/A	%:<b	Wait-time to write request body to server after header

Table 21-11 Log Fields in W3C Logs and Format Specifiers in Access Logs (Continued)

W3C Log Field	Format Specifier in Access Logs	Description
N/A	%:<d	Wait-time to receive the response from the Web Proxy DNS process, after the Web Proxy sent the request.
N/A	%:<h	Wait-time to write request header to server after first byte
N/A	%:<r	Wait-time to receive the response from the Web Reputation Filters, after the Web Proxy sent the request.
N/A	%:<s	Wait-time to receive the verdict from the Web Proxy anti-spyware process, after the Web Proxy sent the request.
N/A	%:>1	Wait-time for first response byte from server
N/A	%:>a	Wait-time to receive the response from the Web Proxy authentication process, including the time required for the Web Proxy to send the request.
N/A	%:>b	Wait-time for complete response body after header received
N/A	%:>c	Time required for the Web Proxy to read a response from the disk cache.
N/A	%:>d	Wait-time to receive the response from the Web Proxy DNS process, including the time required for the Web Proxy to send the request.
N/A	%:C>	Wait-time to receive the response from the Dynamic Content Analysis engine, after the Web Proxy sent the request.
N/A	%:C<	Wait-time to receive the verdict from the Dynamic Content Analysis engine, including the time required for the Web Proxy to send the request.
N/A	%:>h	Wait-time for server header after first response byte

Table 21-11 Log Fields in W3C Logs and Format Specifiers in Access Logs (Continued)

W3C Log Field	Format Specifier in Access Logs	Description
N/A	%:>r	Wait-time to receive the verdict from the Web Reputation Filters, including the time required for the Web Proxy to send the request.
N/A	%:>s	Wait-time to receive the verdict from the Web Proxy anti-spyware process, including the time required for the Web Proxy to send the request.
N/A	%:1<	Wait-time for first request byte from new client connection
N/A	%:1>	Wait-time for first byte written to client
N/A	%:b<	Wait-time for complete client body
N/A	%:b>	Wait-time for complete body written to client
N/A	%:h<	Wait-time for complete client header after first byte
N/A	%:h>	Wait-time for complete header written to client
N/A	%:m<	Wait-time to receive the verdict from the McAfee scanning engine, including the time required for the Web Proxy to send the request.
N/A	%:m>	Wait-time to receive the response from the McAfee scanning engine, after the Web Proxy sent the request.
N/A	%:w<	Wait-time to receive the verdict from the Webroot scanning engine, including the time required for the Web Proxy to send the request.
N/A	%:w>	Wait-time to receive the response from the Webroot scanning engine, after the Web Proxy sent the request.

Configuring Custom Formatting in Access Logs

Use the System Administration > Log Subscriptions page to configure custom formatting for access log file entries. Click the access log file name to edit the access log subscription.

Figure 21-2 Configuring Custom Log Fields in the Access Logs

Edit Log Subscription

Log Subscription	
Log Type:	Access Logs
Log Name:	<input type="text" value="accesslogs"/> <i>(will be used to name the log directory)</i>
Log Style:	<input checked="" type="radio"/> Squid <input type="radio"/> Apache <input type="radio"/> Squid Details
Custom Fields (optional):	<input type="text"/> Custom Fields Reference 

The syntax for entering format specifiers in the Custom Field is as follows:

```
<format_specifier1> <format_specifier2>
```

For example: %a %b %d

You can add tokens before the format specifiers to display descriptive text in the access log file. For example:

```
client_IP %a body_bytes %b error_type %E
```

where `client_IP` is the description token for log format specifier `%a`, `body_bytes` is the descriptive token for `%b`, and `error_type` is the descriptive token for `%c`.

Note — You can create a custom field for any header in a client request or a server response. For more information, see “Including HTTP/HTTPS Headers in Log Files” on page 479.

Configuring Custom Formatting in W3C Logs

Use the System Administration > Log Subscriptions page to configure custom formatting for W3C log file entries. Click the W3C log file name to edit the W3C log subscription.

Figure 21-3 Configuring Custom Log Fields in the W3C Logs

Log Subscription							
Log Type:	W3C Logs						
Log Name:	<input type="text"/> <i>(will be used to name the log directory)</i>						
Log Fields:	<table border="1"> <thead> <tr> <th>Available Log Fields</th> <th>Selected Log Fields</th> </tr> </thead> <tbody> <tr> <td> <ul style="list-style-type: none"> CMF DCF bytes c-ip cs(MIME_type) cs(Referer) cs(User-Agent) cs(cookie_header) cs(X-Forwarded-For) cs-authgroup cs-uri cs-uri cs-method cs-username cs-version date s-computerName s-header </td> <td> <ul style="list-style-type: none"> timestamp x-elapsed-time c-ip x-resultcode-httpstatus sc(response-size) cs-method cs-uri cs-username x-hierarchy-origin cs(MIME_type) x-adtag x-result-code x-suspect-user-agent </td> </tr> <tr> <td> <input type="button" value="Add >>"/> </td> <td> <input type="button" value="Move Up"/> <input type="button" value="Move Down"/> </td> </tr> </tbody> </table>	Available Log Fields	Selected Log Fields	<ul style="list-style-type: none"> CMF DCF bytes c-ip cs(MIME_type) cs(Referer) cs(User-Agent) cs(cookie_header) cs(X-Forwarded-For) cs-authgroup cs-uri cs-uri cs-method cs-username cs-version date s-computerName s-header 	<ul style="list-style-type: none"> timestamp x-elapsed-time c-ip x-resultcode-httpstatus sc(response-size) cs-method cs-uri cs-username x-hierarchy-origin cs(MIME_type) x-adtag x-result-code x-suspect-user-agent 	<input type="button" value="Add >>"/>	<input type="button" value="Move Up"/> <input type="button" value="Move Down"/>
Available Log Fields	Selected Log Fields						
<ul style="list-style-type: none"> CMF DCF bytes c-ip cs(MIME_type) cs(Referer) cs(User-Agent) cs(cookie_header) cs(X-Forwarded-For) cs-authgroup cs-uri cs-uri cs-method cs-username cs-version date s-computerName s-header 	<ul style="list-style-type: none"> timestamp x-elapsed-time c-ip x-resultcode-httpstatus sc(response-size) cs-method cs-uri cs-username x-hierarchy-origin cs(MIME_type) x-adtag x-result-code x-suspect-user-agent 						
<input type="button" value="Add >>"/>	<input type="button" value="Move Up"/> <input type="button" value="Move Down"/>						
Custom Fields <input type="button" value="Add"/>	<input type="button" value="Remove"/>						
	<i>(Use line breaks to separate multiple entries)</i>						

Enter the custom fields to add in the Custom Fields text box in the Log Fields section. You can enter multiple custom fields in the Custom Fields text box and add them simultaneously as long as each entry is separated by a new line (click Enter) before clicking **Add**.

Note — You can create a custom field for any header in a client request or a server response. For more information, see “Including HTTP/HTTPS Headers in Log Files” on page 479.

INCLUDING HTTP/HTTPS HEADERS IN LOG FILES

If the list of predefined access log and W3C log fields does not include all header information you want to log from HTTP/HTTPS transactions, you can type a user defined log field in the Custom Fields text box when you configure the access and W3C log subscriptions.

Custom log fields can be any data from any header sent from the client or the server. If a request or response does not include the header added to the log subscription, the log file includes a hyphen as the log field value.

Table 21-12 defines the syntax to use for access and W3C logs.

Table 21-12 Configuring HTTP/HTTPS Headers in Log Files

Header Type	Access Log Format Specifier Syntax	W3C Log Custom Field Syntax
Header from the client application	%<ClientHeaderName:	cs(<ClientHeaderName)
Header from the server	%<ServerHeaderName:	sc(<ServerHeaderName)

For example, if you want to log the If-Modified-Since header value in client requests, enter the following text in the Custom Fields box for a W3C log subscription:

```
cs (If-Modified-Since)
```

MALWARE SCANNING VERDICT VALUES

A malware scanning verdict is a value assigned to a URL request or server response that determines the probability that it contains malware. The scanning engines return the malware scanning verdict to the DVS engine so the DVS engine can determine whether to monitor or block the scanned object.

They are the result of proprietary calculations that associate a numerical value to the probability that either the URL request or the response content contains malware. Each malware scanning verdict corresponds to a malware category listed on the “Access Policies: Reputation and Anti-Malware Settings” page when you edit the Web Reputation and Anti-Malware Filtering for a particular Access Policy.

Both the Webroot and McAfee scanning engines can return malware scanning verdicts to the DVS engine. For more information about how the DVS engine handles malware scanning verdicts, see “IronPort DVS™ (Dynamic Vectoring and Streaming) Engine” on page 342.

Table 21-13 lists the different malware scanning verdict values and each malware category with which they correspond.

Table 21-13 Malware Scanning Verdict Values

Malware Category	Malware Scanning Verdict Value
Unscannable	3
Other Malware	10
Browser Helper Object	12
Adware	13
System Monitor	14
Commercial System Monitor	18
Dialer	19
Hijacker	20
Phishing URL	21
Trojan Downloader	22
Trojan Horse	23
Trojan Phisher	24
Worm	25
Encrypted File	26

Table 21-13 Malware Scanning Verdict Values (Continued)

Malware Category	Malware Scanning Verdict Value
Virus	27

TRAFFIC MONITOR LOG

The L4 Traffic Monitor log file provides a detailed record of monitoring activity. You can view L4 Traffic Monitor log file entries and track updates to firewall block lists and firewall allow lists. Consider the following example log entries:

Example 1

```
172.xx.xx.xx discovered for blocksite.net (blocksite.net) added to  
firewall block list.
```

In this example, where a match becomes a block list firewall entry. The L4 Traffic Monitor matched an IP address to a domain name in the block list based on a DNS request which passed through the appliance. The IP address is then entered into the block list for the firewall.

Example 2

```
172.xx.xx.xx discovered for www.allowsite.com (www.allowsite.com) added  
to firewall allow list.
```

In this example, a match becomes an allow list firewall entry. The L4 Traffic Monitor matched a domain name entry and added it to the appliance allow list. The IP address is then entered into the allow list for the firewall.

Example 3

```
Firewall noted data from 172.xx.xx.xx to 209.xx.xx.xx  
(allowsite.net):80.
```

In this example, the L4 Traffic Monitor logs a record of data that passed between an internal IP address and an external IP address which is on the block list. Also, the L4 Traffic Monitor is set to monitor, not block.

Configuring Network Settings

This chapter contains the following information:

- “Changing the System Hostname” on page 484
- “Configuring Network Interfaces” on page 485
- “Configuring TCP/IP Traffic Routes” on page 489
- “Virtual Local Area Networks (VLANs)” on page 491
- “Configuring Transparent Redirection” on page 495
- “Configuring SMTP Relay Hosts” on page 502
- “Configuring DNS Server(s)” on page 504

CHANGING THE SYSTEM HOSTNAME

The hostname parameter is used to identify the system at the CLI prompt. You must enter a fully-qualified hostname for the system. The hostname parameter is also used in end-user notification pages, end-user acknowledgement pages, and to form the machine NetBIOS name when the Web Security appliance joins an Active Directory domain. It has no direct relationship with the hostname configured for the interface.

Use the `sethostname` command to change the name of the Web Security appliance:

```
example.com> sethostname  
  
example.com> hostname.com  
  
example.com> commit
```

CONFIGURING NETWORK INTERFACES

You can configure the appliance network interfaces by modifying IP address, subnet, and host name information for the Management, Data, and L4 Traffic Monitor interfaces. Table 22-1 describes the network interface settings you can configure.

Table 22-1 Web Security Appliance Network Interface Settings

Interface	Port Number	Description
Management	M1	By default, the Management interface is used to administer the appliance and Web Proxy (data) monitoring. However, you can configure the M1 port for management use only.
Data	P1 and P2 (proxy)	The Data interfaces are used for Web Proxy monitoring and L4 Traffic Monitor blocking (optional). You can also configure these interfaces to support outbound services such as DNS, software upgrades, NTP, and traceroute data traffic. For more information about configuring the Data interfaces, see “Configuring the Data Interfaces” on page 485.
L4 Traffic Monitor	T1 and T2	The L4 Traffic Monitor interfaces are used to configure a duplex or simplex wiring type. <ul style="list-style-type: none"> • Duplex. The T1 interface receives incoming and outgoing traffic. • Simplex. T1 receives outgoing traffic and T2 receives incoming traffic.

Note — If the Management and Data interfaces are all configured, each must be assigned IP addresses on different subnets.

You can manage the network interfaces using the following methods:

- **Web interface.** Use the Network > Interfaces page. For more information, see “Configuring the Network Interfaces from the Web Interface” on page 486.
- **Command line interface.** Use the `ifconfig` CLI command to create, edit, and delete network interfaces.

Configuring the Data Interfaces

You can configure the Web Security appliance to use any of the following combinations of network interfaces for data traffic:

- M1 only
- M1 and P1
- M1, P1, and P2

- P1 only
- P1 and P2

You can enable the M1 and P1 ports during or after System Setup. However, you can only enable the P2 port after System Setup in the web interface or using the `ifconfig` CLI command.

The Web Proxy listens for client web requests on different network interfaces depending on how you configure the Web Security appliance:

- **M1.** The Web Proxy listens for requests on this interface when it is not configured to be restricted to appliance management services only.
- **P1.** The Web Proxy listens for requests on this interface when it is enabled.
- **P2.** By default, the Web Proxy does not listen for requests on this interface, even when enabled. However, you can configure it to listen for requests on P2 using the `advancedproxyconfig > miscellaneous` CLI command.

To configure the appliance to use P2 as a second data interface:

1. Configure the appliance to use P1 as the interface for data traffic. You can do this during System Setup or after initial setup on the Network > Interfaces page.
2. Enable P2 in the web interface (see “Configuring the Network Interfaces from the Web Interface” on page 486) or using the `ifconfig` CLI command.

Note — If the Management and Data interfaces are all configured, each must be assigned IP addresses on different subnets.

3. In the web interface, go to the Network > Routes page. Change the Default Route for data traffic to specify the next IP address that the P2 interface is connected to.

Note — If you enable P2 to listen for client requests using the `advancedproxyconfig > miscellaneous` CLI command, you can choose whether to use P1 or P2 for outgoing traffic. To use P1 for outgoing traffic, change the Default Route for data traffic to specify the next IP address that the P1 interface is connected to.

Configuring the Network Interfaces from the Web Interface

To configure the network interfaces from the web interface:

1. Navigate to the Network > Interfaces page. Click **Edit Settings**.

The Edit Interfaces page appears.

Figure 22-1 Editing Network Interfaces

Edit Interfaces

Interfaces				
Interfaces:	Ethernet Port	IP Address	Netmask	Hostname
	M1	<input type="text" value="10.1.1.101"/>	<input type="text" value="255.255.255.0"/>	<input type="text" value="wsa.domain.com"/>
	P1	<input type="text"/>	<input type="text"/>	<input type="text"/>
	P2	<input type="text"/>	<input type="text"/>	<input type="text"/>
<i>Port M1 is required to be configured as the interface for Management Services. Other interfaces are optional unless separate routing for management services is selected below.</i>				
Separate Routing for Management Services:	<input type="checkbox"/> Restrict M1 port to appliance management services only <i>If this option is selected, another port must be configured for Data, and separate routes must be configured for Management and Data traffic. Confirm routing table entries using Network > Routes.</i>			
Appliance Management Services:	<input checked="" type="checkbox"/> HTTP <input type="text" value="8080"/> <input checked="" type="checkbox"/> HTTPS <input type="text" value="8443"/> <input checked="" type="checkbox"/> Redirect HTTP requests to HTTPS (HTTP and HTTPS Services will be turned on) <i>Warning: Please exercise care when disabling or changing these items, as this could disrupt active connections to this appliance when changes to these items are committed</i>			
L4 Traffic Monitor Wiring:	<input checked="" type="radio"/> Duplex TAP: T1 (In/Out) <input type="radio"/> Simplex TAP: T1 (In) and T2 (Out)			

2. Configure interface settings as necessary.

Table 22-2 describes the interface settings you can define for each interface.

Table 22-2 Interface Settings

Interface Setting	Description
IP Address	Enter the IP address to use to manage the Web Security appliance. Enter an IP address that exists on your management network.
Netmask	Enter the network mask to use when managing the Web Security appliance on this network interface.
Hostname	Enter the hostname to use when managing the Web Security appliance on this network interface.

3. Specify whether or not to have separate routing for the Management Services using the “Restrict M1 port to appliance management services only” field.

If this checkbox is selected, the M1 port is used for appliance management services only and is not used for the data (Web Proxy) traffic. You will need to configure another port for data traffic as well as separate routes for management and data traffic. For more information about configuring routes, see “Configuring TCP/IP Traffic Routes” on page 489.

4. Configure Appliance Management Services.

Choose whether or not to use HTTP or HTTPS to administer AsyncOS through the web interface. You must specify the port to access AsyncOS with each protocol you configure.

You can also choose to redirect HTTP requests to HTTPS. When you do this, AsyncOS automatically enables both HTTP and HTTPS.

5. Choose the type of wired connections plugged into the “T” network interfaces:
 - **Duplex TAP.** Choose Duplex TAP when the T1 port receives both incoming and outgoing traffic. You can use half- or full-duplex Ethernet connections.
 - **Simplex TAP.** Choose Simplex TAP when you connect the T1 port to the internal network (traffic flows from the clients to the Internet) and you connect the T2 port to the external network (traffic flows from the Internet to the clients).

Note — IronPort recommends using simplex when possible because it can increase performance and security.

6. Submit and commit your changes.

CONFIGURING TCP/IP TRAFFIC ROUTES

You can administer routes for data and management traffic, add static routes, load your IP routing tables, and modify the default gateway using the Network > Routes page or the `routeconfig` command.

The number of sections on this page is determined by how the “Restrict M1 port to appliance management services only” check box is configured on the Network > Interfaces page:

- **Separate route configuration sections for Management and Data traffic.** When you use the Management interface for management traffic only (“Restrict M1 port” is enabled), then this page includes two sections to enter route table information, one for management traffic and one for data traffic. AsyncOS uses the management route information for management traffic only, and data route information for data traffic. Figure 22-3 on page 490 shows the Routes page when the option is enabled.
- **One route configuration section for all traffic (Management and Data).** When you use the Management interface for both management and data traffic (“Restrict M1 port” is disabled), then this page includes one section to enter route table information for all traffic that leaves the Web Security appliance, both management and data traffic.

Note — A route gateway must reside on the same subnet as the Management or Data interface on which it is configured.

Modifying the Default Route

You can modify the default gateway in the web interface or in the CLI using the `setgateway` CLI command.

Note — The Web Proxy sends out transactions on the data interface that is on the same network as the default gateway configured for data traffic.

To modify the default gateway in the web interface:

1. Navigate to the Network > Routes page, and click on Default Route in the corresponding table.

Figure 22-2 Editing the Default Route

Edit Default Route for Management and Data (Interface M1: 10.1.1.1, Interface P1: 10.1.2.1)

Default Gateway Settings		
Name	Destination Network	Gateway
Default Route	All Others (Including External)	10.5.5.1

2. In the Gateway column, enter the IP address of the computer system on the next hop of the network connected to the network interface you are editing.
3. Submit and commit your changes.

Working With Routing Tables

You can save your current routing table to a file. You can load a previously saved route table. You can add new routes or delete existing ones.

To save a route table, click **Save Route Table** and specify where to save the file.

To load a previously saved route table, click **Load Route Table**, navigate to the file, and then submit and commit your changes.

Note — When the destination address is on the same subnet as one of the physical network interfaces, AsyncOS sends data using the network interface with the same subnet. It does not consult the routing tables.

To add a route:

1. Navigate to the Network > Routes page.

Figure 22-3 Adding a Route

Routes

The screenshot displays two routing table configuration panels. The top panel is titled "Routes for Management Traffic (Interface M1: 196.1.10.200)" and contains a table with one row: "Default Route" with destination "All Others" and gateway "196.196.0.1". The bottom panel is titled "Routes for Data Traffic (Interface P1: 196.1.11.190)" and contains a table with one row: "Default Route" with destination "All Others (Including External)" and gateway "196.196.2.1". Both panels include "Add Route...", "Save Route Table...", and "Load Route Table..." buttons. A "Delete" button is located at the bottom right of each table.

Name	Destination Network	Gateway	All Delete
Default Route	All Others	196.196.0.1	

Name	Destination Network	Gateway	All Delete
Default Route	All Others (Including External)	196.196.2.1	

2. Click the **Add Route** button corresponding to the interface for which you are creating the route. The Add Route page is displayed.
3. Enter a Name, Destination Network, and Gateway.
4. Submit and commit your changes.

VIRTUAL LOCAL AREA NETWORKS (VLANs)

VLANs are virtual local area networks bound to physical data ports. You can configure one or more VLANs to increase the number of networks the IronPort appliance can connect to beyond the number of physical interfaces included. For example, a Web Security appliance has two data interfaces available for VLANs: P1 and Management. VLANs allow more networks to be defined on separate “ports” on existing interfaces. Figure 22-4 provides an example of configuring several VLANs on the P1 interface.

Figure 22-4 Using VLANs to Increase the Number of Networks Available on the Appliance

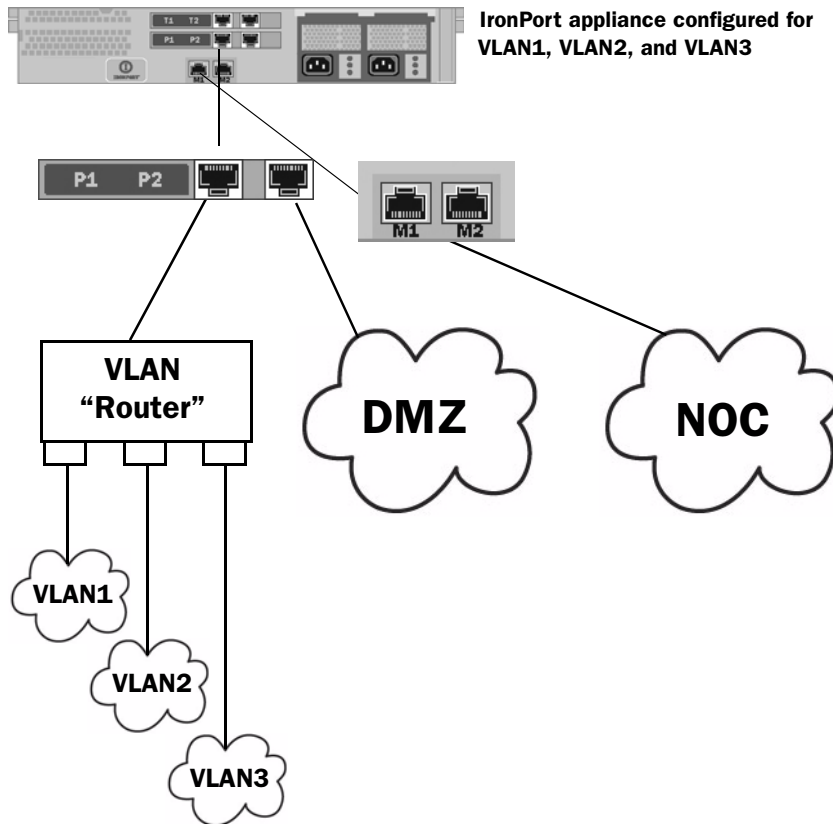

VLANs can be used to segment networks for security purposes, to ease administration, or increase bandwidth. For example, create multiple VLANs on the P1 interface and then apply different policies to each. VLANs appear as dynamic “Data Ports” labeled in the format of: “VLAN DDDD” where the “DDDD” is the ID and is an integer up to 4 digits long (VLAN 2, or VLAN 4094 for example). AsyncOS supports up to 30 VLANs. Duplicate VLAN IDs are not allowed on an IronPort appliance.

VLANs and Physical Ports

A physical port does not need an IP address configured in order to be in a VLAN. The physical port on which a VLAN is created can have an IP that will receive non-VLAN traffic, so you can have both VLAN and non-VLAN traffic on the same interface.

VLANs can only be created on the Management and P1 data ports.

Managing VLANs

You can create, edit and delete VLANs via the `etherconfig` command. Once created, a VLAN can be configured via the `interfaceconfig` command in the CLI. Remember to commit all changes.

Creating a New VLAN via the `etherconfig` Command

In this example, two VLANs are created (named VLAN 31 and VLAN 34) on the P1 port:

Note — Do not create VLANs on the T1 or T2 interfaces.

```
example.com> etherconfig
Choose the operation you want to perform:
- MEDIA - View and edit ethernet media settings.
- VLAN - View and configure VLANs.
- MTU - View and configure MTU.
[]> vlan

VLAN interfaces:

Choose the operation you want to perform:
- NEW - Create a new VLAN.
[]> new

VLAN ID for the interface (Ex: "34"):
[]> 34

Enter the name or number of the ethernet interface you wish bind to:
1. Management
2. P1
3. T1
4. T2
[1]> 2

VLAN interfaces:
1. VLAN 34 (P1)

Choose the operation you want to perform:
- NEW - Create a new VLAN.
- EDIT - Edit a VLAN.
- DELETE - Delete a VLAN.
```

```
[ ]> new

VLAN ID for the interface (Ex: "34"):
[ ]> 31

Enter the name or number of the ethernet interface you wish bind to:
1. Management
2. P1
3. T1
4. T2
[1]> 2

VLAN interfaces:
1. VLAN 31 (P1)
2. VLAN 34 (P1)

Choose the operation you want to perform:
- NEW - Create a new VLAN.
- EDIT - Edit a VLAN.
- DELETE - Delete a VLAN.
[ ]>
```

Creating an IP Interface on a VLAN via the `interfaceconfig` Command

In this example, a new IP interface is created on the VLAN 34 ethernet interface.

Note — Making changes to an interface may close your connection to the appliance.

```
example.com> interfaceconfig

Currently configured interfaces:
1. Management (10.10.1.10/24 on Management: example.com)
2. P1 (10.10.0.10 on P1: example.com)

Choose the operation you want to perform:
- NEW - Create a new interface.
- EDIT - Modify an interface.
- GROUPS - Define interface groups.
- DELETE - Remove an interface.
[ ]> new

IP Address (Ex: 10.10.10.10):
[ ]> 10.10.31.10

Ethernet interface:
1. Management
2. P1
```

```
3. VLAN 31
4. VLAN 34
[1]> 4

Netmask (Ex: "255.255.255.0" or "0xffffffff"):
[255.255.255.0]>

Hostname:
[ ]> v.example.com

Currently configured interfaces:
1. Management (10.10.1.10/24 on Management: example.com)
2. P1 (10.10.0.10 on P1: example.com)
3. VLAN 34 (10.10.31.10 on VLAN 34: v.example.com)

Choose the operation you want to perform:
- NEW - Create a new interface.
- EDIT - Modify an interface.
- DELETE - Remove an interface.
[ ]>

example.com> commit
```

CONFIGURING TRANSPARENT REDIRECTION

When you configure the Web Security appliance web proxy service in transparent mode, you must connect the appliance to an L4 switch or a WCCP v2 router, and you must configure the appliance so it knows to which device it is connected. You configure the device on the Network > Transparent Redirection page.

Figure 22-5 Network > Transparent Redirection Page

Transparent Redirection

Transparent Redirection Device				
Type:		WCCP v2 Router		
Edit Device...				

WCCP v2 Services				
Add Service...				
Service Profile Name	Service ID	Router IP Addresses	Ports	Delete
webcache	0 (web-cache)	10.1.1.1, 100.11.11.11, 111.111.111.111, 101.1.1.1	80	
return_web	99	10.1.1.1, 100.11.11.11, 111.111.111.111, 101.1.1.1	80,443	

On this page, you can choose the device that transparently redirects traffic to the appliance, either an L4 switch or a WCCP router. When you choose an L4 switch as the device, there is nothing else to configure on this page.

However, when you choose a WCCP router as the device, you must create at least one WCCP service.

Working with WCCP Services

A WCCP service is an appliance configuration that defines a service group to a WCCP v2 router. It includes information such as the service ID and ports used. Service groups allow a web proxy to establish connectivity with a WCCP router and to handle redirected traffic from the router.

You can create WCCP services that use the following service types:

- **Standard service.** The standard service is also known as a well known service because the characteristics of it are known by both WCCP routers and the appliance. It redirects traffic on port 80. It is identified as the “web-cache” service.
- **Dynamic service.** Dynamic services are any other service a web proxy creates, but the web proxy must describe the components of the service group to the router. AsyncOS supports the creation of any dynamic service you choose to define. To create a dynamic service, you must provide the service ID number, port numbers, and specify whether to redirect packets based on the destination or source port and whether to distribute packets based on the client or server address.

The Web Cache Communication Protocol allows 257 different service IDs. AsyncOS allows you to create a dynamic WCCP service for each possible service ID. However, in typical usage, most users create one or two WCCP services, where one is a standard service and the other a dynamic service.

When you create a WCCP service of any type, you must also specify the following information:

- **Assignment method.** For more information, see “Working with the Assignment Method” on page 496.
- **Forwarding and Return method.** For more information, see “Working with the Forwarding and Return Method” on page 497.

If you enable IP spoofing on the appliance, you must create two WCCP services. For more information, see “IP Spoofing when Using WCCP” on page 497.

Working with the Assignment Method

WCCP defines the assignment method as the method by which redirected packets are distributed between web proxies. In this case, between one or more Web Security appliances. The assignment method determines how the router performs load balancing of packets among multiple Web Security appliances.

You configure the assignment method for a WCCP service in the Load-Balancing Method field under the Advanced section when you create or edit a WCCP service.

You can configure WCCP services to use either of the following assignment methods:

- **Mask.** This method relies on masking to make redirection decisions. WCCP routers make decisions using hardware in the router. This method can be very efficient because the hardware redirects the packets. You might want to choose mask to reduce CPU cycles on the router which can increase router performance. You can only use mask with WCCP routers that support mask assignment.

Note — AsyncOS chooses the mask value to use with the router. You cannot configure the mask value.

- **Hash.** This method relies on a hash function to make redirection decisions. You might want to use Hash when the WCCP router does not support masking.

You can also configure a WCCP service to allow either mask or hash load balancing. When a WCCP service allows both mask and hash, AsyncOS communicates with the router to determine whether or not the router supports mask. If the router supports mask, then AsyncOS uses masking in the service group, if the router does not support mask, then AsyncOS uses hashing in the service group.

Working with the Forwarding and Return Method

WCCP defines the forwarding method as the method by which redirected packets are transported from the router to the web proxy. Conversely, the return method redirects packets from the web proxy to the router.

You configure the forwarding and return methods for a WCCP service in the Forwarding Method and Return Method fields under the Advanced section when you create or edit a WCCP service.

You can configure WCCP services to use either of the following methods:

- **Layer 2 (L2).** This method redirects traffic at layer 2 by replacing the packet's destination MAC address with the MAC address of the target web proxy. This method requires that the target web proxy be directly connected to the router at layer 2. WCCP routers only allow L2 negotiation when the appliance is directly connected to the router at layer 2. The L2 method redirects traffic at the router hardware level, and typically has better performance than Generic Routing Encapsulation (GRE). You might want to choose L2 when the router is directly connected to the appliance and you want the performance improvement provided by the L2 method. You can only use the L2 method with WCCP routers that support L2 forwarding.
- **Generic Routing Encapsulation (GRE).** This method redirects traffic at layer 3 by encapsulating the IP packet with a GRE header and a redirect header. This method redirects traffic at the router software level, which can impact performance. You might want to choose GRE when the appliance is not directly connected to the router.

You can also configure a WCCP service to allow either the L2 or GRE methods. When a WCCP service allows both L2 and GRE, the appliance uses the method that the router says it supports. If both the router and appliance support L2 and GRE, the appliance uses L2.

Note — If the router is not directly connected to the appliance, you must choose GRE.

IP Spoofing when Using WCCP

You can configure the Web Proxy to do IP spoofing. When enabled, requests originating from a client retain the client's source address and appear to originate from the client instead of the Web Proxy.

When you enable IP spoofing, you must create two WCCP services. One WCCP service must redirect traffic based on the destination port, and another based on the source port for the return path. The service based on the destination port can be the standard web-cache service. However, you must still create at least one dynamic service.

The two WCCP services you define for IP spoofing must have the same values for the following settings:

- Port numbers
- Router IP addresses
- Router security and password

Note — IronPort suggests using a service ID number from 90 to 99 for the WCCP service used for the return path (based on the source port).

For more information about creating WCCP services, see “Adding and Editing a WCCP Service” on page 498.

Adding and Editing a WCCP Service

You must create at least one WCCP service when you configure the transparent redirection device as a WCCP router. If IP spoofing is enabled on the appliance, you must create two WCCP services. For more information about IP spoofing, see “IP Spoofing when Using WCCP” on page 497.

To add or edit a WCCP service:

1. Navigate to the Network > Transparent Redirection page.

Transparent Redirection

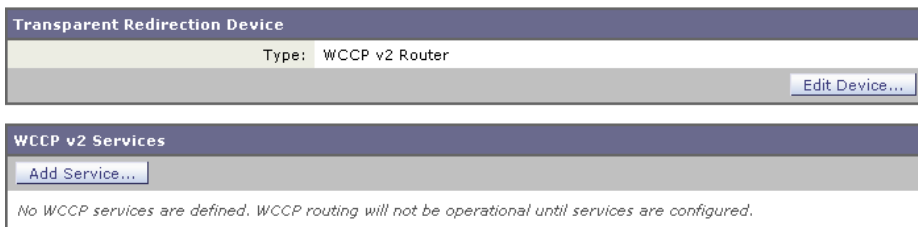

The screenshot displays two main configuration panels. The first panel, titled "Transparent Redirection Device", has a dark blue header and a light gray body. It shows "Type: WCCP v2 Router" and an "Edit Device..." button. The second panel, titled "WCCP v2 Services", also has a dark blue header and a light gray body. It features an "Add Service..." button and a message: "No WCCP services are defined. WCCP routing will not be operational until services are configured."

2. Verify the transparent redirection device is a WCCP v2 router. If it is not, click **Edit Device** to change it.
3. To add a WCCP service, click **Add Service**. Or, to edit a WCCP service, click the name of the WCCP service in the Service Profile Name column.

The Add WCCP v2 Service page or Edit WCCP v2 Service page appears.

Add WCCP v2 Service

WCCP v2 Service

Service Profile Name:

Service: Standard service ID: 0 web-cache (destination port 80)

Dynamic service ID:

Port numbers:

(up to 8 port numbers, separated by commas)

Redirect based on destination port

Redirect based on source port (return path)

For IP spoofing, define two services, one based on destination port and another based on source port (return path).

Load balance based on server address

Load balance based on client address

Applies only if more than one Web Security Appliance is in use.

Router IP Addresses:

Separate multiple entries with line breaks or commas.

Router Security: Enable Security for Service

 Password:

 Confirm Password:

Advanced:

 Load-Balancing Method:

 Forwarding Method:

 Return Method:

4. Configure the WCCP options.

Table 22-3 describes the WCCP options.

Table 22-3 WCCP Service Options

WCCP Service Option	Description
Service Profile Name	Enter a name for the WCCP service.

Table 22-3 WCCP Service Options (Continued)

WCCP Service Option	Description
Service	<p>Use this section to describe the service group for the router. Choose to create either a standard (“well known”) or dynamic service group.</p> <p>If you create a dynamic service, enter the following information:</p> <ul style="list-style-type: none"> • Service ID. Enter any number from 0 to 255 in the Dynamic Service ID field. • Port number(s). Enter up to eight port numbers for traffic to redirect in the Port Numbers field. • Redirection basis. Choose to redirect traffic based on the source or destination port. Default is destination port. • Load balancing basis. When the network uses multiple Web Security appliances, you can choose how to distribute packets among the appliances. You can distribute packets based on the server or client address. When you choose client address, packets from a client always get distributed to the same appliance. Default is server address. <p>For more information about well known and dynamic service groups, see “Working with WCCP Services” on page 495.</p>
Router IP Addresses	<p>Enter the IP address for one or more WCCP enabled routers. You can enter up to 32 routers to the service group. You must enter the IP address of each router. You cannot enter a multicast address.</p>
Router Security	<p>Choose whether or not to require a password for this service group. If required, enter the password in the password fields. The password can contain up to seven characters.</p> <p>When you enable security for a service group, every appliance and WCCP router that uses the service group must use the same password.</p> <p>Requiring a password enables you to control which routers and WCCP-enabled systems, such as the Web Security appliance, become part of the service group.</p> <p>WCCP uses the MD5 hash protocol to encrypt the password.</p> <p>Note — Each appliance or WCCP router in the service group authenticate the security component in a received WCCP packet immediately after validating the WCCP message header. Packets failing authentication are discarded.</p>

Table 22-3 WCCP Service Options (Continued)

WCCP Service Option	Description
Advanced	Configure the following fields: <ul style="list-style-type: none"> <li data-bbox="626 310 1228 412">• Load-Balancing Method. This is also known as the assignment method. Choose Mask, Hash, or both. Default is both. For more information about load-balancing, see “Working with the Assignment Method” on page 496. <li data-bbox="626 418 1228 521">• Forwarding Method. Choose L2, GRE, or both. Default is both. For more information about the forwarding method, see “Working with the Forwarding and Return Method” on page 497. <li data-bbox="626 527 1228 605">• Return Method. Choose L2, GRE, or both. Default is both. For more information about the return method, see “Working with the Forwarding and Return Method” on page 497.

5. Submit and commit your changes.

Deleting a WCCP Service

To delete a WCCP service:

1. Navigate to the Network > Transparent Redirection page.
2. Click the icon in the Delete column for the WCCP service you want to delete.
3. Commit your changes.

CONFIGURING SMTP RELAY HOSTS

AsyncOS periodically sends system-generated email messages, such as notifications, alerts, and IronPort Customer Support requests. By default, AsyncOS uses information listed in the MX record on your domain to send email. However, if the appliance cannot directly reach the mail servers listed in the MX record, you must configure at least one SMTP relay host on the appliance.

You might want to configure an SMTP relay host in the following scenarios:

- You want the system-generated emails to go to a non-local email address, and port 25 is blocked to outside networks.
- Your mail servers do not allow direct port 25 traffic from internal hosts.

If no SMTP relay host is defined, AsyncOS delivers directly to the mail server for each email address.

Note — If the Web Security appliance cannot communicate with the mail servers listed in the MX record or any of the configured SMTP relay hosts, it cannot send email messages and it writes a message in the log files.

You can configure one or more SMTP relay hosts. You might want to configure multiple SMTP relay hosts for redundancy in case one system becomes unavailable. When you configure multiple SMTP relay hosts, AsyncOS uses the topmost available SMTP relay host. If an SMTP relay host is unavailable, it tries to use the one below it in the list.

You can configure the SMTP relay host from either the web interface or command line interface:

- **Web interface.** Use the Network > Internal SMTP Relay page.
- **Command line interface.** Use the `smtprelay` CLI command.

Configuring SMTP from the Web Interface

Use the Network > Internal SMTP Relay page.

To configure the SMTP relay host from the web interface:

1. Navigate to the Network > Internal SMTP Relay page, and click **Edit Settings**.

Edit Internal SMTP Relay Settings

SMTP Relay Settings			
Internal SMTP Relay Hosts:	Relay Hostname or IP Address	Port (?)	Add Row
	<input type="text"/> <small>i.e., smtp.example.com, 10.0.0.3</small>	<input type="text"/> <small>optional</small>	
Routing Table to Use for SMTP:	Management		

2. Enter the information listed in Table 22-4.

Table 22-4 SMTP Relay Host Settings

Property	Description
Relay Hostname or IP Address	Enter the host name or IP address to use for the SMTP relay
Port	Enter the port for connecting to the SMTP relay. If this property is empty, the appliance uses port 25. This property is optional.
Routing Table to Use for SMTP	Choose the routing table associated with an appliance network interface, either Management or Data, to use for connecting to the SMTP relay. Choose whichever interface is on the same network as the relay system.

3. Optionally, you can add more SMTP relay host information by clicking **Add Row**.
4. Submit and commit your changes.

Configuring SMTP from the CLI

Use the `smtprelay` command to configure SMTP relay hosts.

For example:

```
example.com> smtprelay

No internal SMTP relay host configured.

Choose the operation you want to perform:

- NEW - Add a new host.

[ ]> new

Please enter the hostname of your relay host. You may put a colon
after the hostname to indicate a port to use other than 25, such as
"smtp.example.com:547".
```

CONFIGURING DNS SERVER(S)

You can configure the DNS settings for your IronPort appliance using the Network > DNS page or using the `dnsconfig` command. Before you configure DNS, consider the following:

- Whether to use the Internet's DNS servers or your own, and which specific server(s) to use.
- Which routing table to use for DNS traffic.

You must use the routing table associated with the interface that faces the DNS server, either Data or Management.

- The number of seconds to wait before timing out a reverse DNS lookup.
- Clearing the DNS cache.

Specifying DNS Servers

IronPort AsyncOS can use the Internet root DNS servers, your own DNS servers, or the Internet root DNS servers and authoritative DNS servers that you specify. When using the Internet root servers, you can specify alternate servers to use for specific domains. Since an alternate DNS server applies to a single domain, it must be authoritative (provide definitive DNS records) for that domain.

Split DNS

AsyncOS supports split DNS where internal servers are configured for specific domains and external or root DNS servers are configured for other domains. If you are using your own internal server, you can also specify exception domains and associated DNS servers.

Using the Internet Root Servers

The IronPort AsyncOS DNS resolver is designed to accommodate the large number of simultaneous DNS connections.

Multiple Entries and Priority

For each DNS server you enter, you can specify a numeric priority. AsyncOS will attempt to use the DNS server with the priority closest to 0. If that DNS server is not responding AsyncOS will attempt to use the server at the next priority. If you specify multiple entries for DNS servers with the same priority, the system randomizes the list of DNS servers at that priority every time it performs a query. The system then waits a short amount of time for the first query to expire or "time out" and then increments with a slightly longer amount of time for subsequent servers. The amount of time depends on the exact number of DNS servers and priorities that have been configured. The timeout length is the same for all IP addresses at any particular priority. The first priority gets the shortest timeout, each subsequent priority gets a longer timeout. Further, the timeout period is roughly 60 seconds. If you have one priority, the timeout for each server at that priority is 60 seconds. If you have two priorities, the timeout for each server at the first priority is 15 seconds, and each server at the second priority is 45 seconds. For three priorities, the timeout increments are 5, 10, 45.

For example, four DNS servers with two configured at priority 0, one at priority 1, and one at priority 2:

Table 22-5 Example of DNS Servers, Priorities, and Timeout Intervals

Priority	Server(s)	Timeout (seconds)
0	1.2.3.4, 1.2.3.5	5, 5
1	1.2.3.6	10
2	1.2.3.7	45

AsyncOS randomly chooses between the two servers at priority 0. If one of the priority 0 servers is down, the other is used. If both priority 0 servers are down, the priority 1 server (1.2.3.6) is used, and finally, the priority 2 (1.2.3.7) server.

The timeout period is the same for both priority 0 servers, longer for the priority 1 server, and longer still for the priority 2 server.

DNS Alert

If an alert with the message “Failed to bootstrap the DNS cache” is generated when an appliance is rebooted, it means that the system was unable to contact its primary DNS servers. This can happen at boot time if the DNS subsystem comes online before network connectivity is established. If this message appears at other times, it could indicate network issues or that the DNS configuration is not pointing to a valid server.

Clearing the DNS Cache

You can use the Clear DNS Cache button on Network > DNS page, or the `dnsflush` command to clear all information in the DNS cache when changes have been made to your local DNS system. Using this command might cause a temporary performance degradation while the cache is repopulated.

Configuring DNS

To edit DNS Settings:

1. Navigate to the Network > DNS page.
2. Click **Edit Settings**. The Edit DNS page appears.

Figure 22-6 Edit DNS Settings

Edit DNS

DNS Server Settings

DNS Servers: Use these DNS Servers

Priority (?)	Server IP	Add Row
0	172.17.0.3	

Alternate DNS servers Overrides (Optional):

Domain(s)	DNS Server IP Address	Add Row
 <i>i.e., example.com, example2.com</i>	 <i>i.e., 10.0.0.3</i>	

Use the Internet's Root DNS Servers

Alternate DNS servers Overrides (Optional):

Domain	DNS Server FQDN	DNS Server IP Address	Add Row
 <i>i.e., example.com</i>	 <i>i.e., dns.example.com</i>	 <i>i.e., 10.0.0.3</i>	

Routing Table for DNS Traffic: Management

Wait Before Timing out Reverse DNS Lookups: 20 seconds

Domain Search List: (?)

Separate multiple entries with commas.

3. Select to use the Internet's root DNS servers or your own internal DNS server or the Internet's root DNS servers and specify authoritative DNS servers.
4. If you use your own DNS server(s), or specify authoritative DNS servers, enter the server ID, specify a priority, and use the Add Row key to repeat as necessary for each server.
5. Choose the routing table associated with an appliance network interface type, either Management or Data, to use for DNS traffic.
6. Enter the number of seconds to wait before cancelling a reverse DNS lookup.
7. Submit and commit to save the changes.

System Administration

This chapter contains the following information:

- “Managing the S-Series Appliance” on page 508
- “Support Commands” on page 509
- “Working with Feature Keys” on page 515
- “Administering User Accounts” on page 517
- “Configuring Administrator Settings” on page 523
- “Configuring the Return Address for Generated Messages” on page 524
- “Managing Alerts” on page 525
- “Setting System Time” on page 532
- “Installing a Server Digital Certificate” on page 534
- “Upgrading the System Software” on page 537
- “Configuring Upgrade and Service Update Settings” on page 539

MANAGING THE S-SERIES APPLIANCE

The S-Series appliance provides a variety of tools for managing the system. Functionality on System Administration tab helps you manage the following tasks:

- Appliance configuration
- Feature keys
- Adding, editing, and removing user accounts
- AsyncOS software upgrades
- Updates to security components
- System time

Managing the Appliance Configuration

To archive the current configuration, use the System Administration > Configuration pages to print a summary of appliance settings and create a local copy of the system configuration file. The system configuration file can be used to import a complete configuration or to load a unique sub-section and update specific settings.

Use the System Administration > Configuration File page to load a copy of the current configuration onto the appliance or to copy the configuration to a local host.

To load a copy of the configuration file, paste the configuration directly into the web interface page. At the top of the configuration file you must include the following tag:

```
<?xml version="1.0" encoding="ISO-8859-1"?> <!DOCTYPE config SYSTEM  
"config.dtd"> <config> ... your configuration information in valid XML </config>
```

After loading the XML sub-section, submit and commit the update.

Committing Changes to the Appliance Configuration

Each time you modify settings and change appliance behavior using the S-Series web interface, you must first submit your changes and then commit them to the active configuration.

For more information about committing changes, see “Committing and Clearing Changes” on page 25.

SUPPORT COMMANDS

The features in this section are useful when you upgrade the appliance or contact your support provider. You can find the following commands under the Technical Support section of the Support and Help menu:

- **Open a Support Case.** For more information, see “Open a Support Case” on page 509.
- **Remote Access.** For more information, see “Remote Access” on page 510.
- **Packet Capture.** For more information, see “Packet Capture” on page 511.

Open a Support Case

You can use the appliance to send an email to IronPort Customer Support asking for assistance. When the appliance sends the email, it also sends the configuration of the appliance. You can do this in the following ways:

- **CLI.** Use the `supportrequest` command.
- **Web interface.** Use the Support and Help menu > Open a Support Case page.

When you send a support request, you can enter comments describing the issue for which you need support. The appliance must be able to send mail to the Internet to send a support request.

To send a support request in the web interface:

1. From the Support and Help menu, choose Open a Support Case.

Figure 23-1 Open a Technical Support Case Page

Open a Technical Support Case

Technical Support Case	
Send Request to:	<input checked="" type="checkbox"/> IronPort Customer Support Other recipients (optional): <input type="text"/> <i>Separate multiple email addresses with commas.</i>
Contact Information:	Name: <input type="text"/> Email: <input type="text"/> Other Contact Information (optional): <input type="text"/> Phone1: <input type="text"/> Phone2: <input type="text"/> <i>(Mobile, Pager, etc.)</i> Other: <input type="text"/>
Issue Priority:	4 - Request for information or new feature ▼
Issue Description:	Issue Subject: <input type="text"/> Issue Description: <input type="text"/>
Customer Support Case Number (optional):	If you are adding comments to an existing case, please provide the case number. <input type="text"/>

- In the Other Recipients field, enter other email addresses separated by commas if you want to send this support request to other people.
By default, the support request (including the configuration file) is sent to IronPort Customer Support (via the checkbox at the top of the form).
- Enter your contact information, such as name and email.
- From the Issue Priority field, select the priority of this support request.
- In the Issue Subject field, enter the text to use in the subject line of the email that will be sent.
- In the Issue Description field, enter a description of the issue.
- If you have a customer support ticket already for this issue, enter it.
- Click **Send**.

A trouble ticket is automatically created with IronPort. For additional information, see “IronPort Customer Support” on page 11.

Remote Access

Use the Support and Help menu > Remote Access page to allow IronPort Customer Support remote access to the Web Security appliance. Click **Edit Remote Access Settings** to allow IronPort Customer Support to access the appliance.

Figure 23-2 Remote Access Page

Edit Customer Support Remote Access

Customer Support Remote Access	
<input checked="" type="checkbox"/> Allow remote access to this appliance	
Customer Support Password:	<input type="password"/> <i>Cannot be the same as your admin password</i>
Secure Tunnel (recommended):	<input checked="" type="checkbox"/> Initiate connection via secure tunnel Port: <input type="text" value="443"/>
Appliance Serial Number:	00000000

By enabling Remote Access you are activating a special account used by IronPort Customer Support for debugging and general access to the system. This is used by IronPort Customer Support for tasks such as assisting customers in configuring their systems, understanding configurations, and investigating problem reports. You can also use the `techsupport` command in the CLI.

When enabling the “Secure Tunnel,” the appliance creates an SSH tunnel over the specified port to the server `upgrades.ironport.com`. By default this connection is over port 443, which will work in most environments. Once a connection is made to `upgrades.ironport.com`, IronPort Customer Support is able to use the SSH tunnel to obtain access to the appliance. As long as the connection over port 443 is allowed, this will bypass most firewall restrictions. You can also use the `techsupport tunnel` command in the CLI.

In both the “Remote Access” and “Tunnel” modes, a password is required. It is important to understand that this is *not* the password that will be used to access the system. Once that password and the system serial number are provided to your Customer Support representative, a password used to access the appliance is generated.

Once the `techsupport` tunnel is enabled, it will remain connected to `upgrades.ironport.com` for 7 days. After 7 days, no new connections can be made using the `techsupport` tunnel. If there are any existing connections using the tunnel after 7 days, those connections will continue to exist and work. However, once those connections are closed, they will not be able to open again because the `techsupport` tunnel will have closed after 7 days. The timeout set on the SSH tunnel connection does not apply to the Remote Access account; it will remain active until specifically deactivated.

Packet Capture

Sometimes when you contact IronPort Customer Support with an issue, you may be asked to provide insight into the network activity going into and out of the Web Security appliance. The appliance provides the ability to intercept and display TCP/IP and other packets being transmitted or received over the network to which the appliance is attached.

You might want to run a packet capture to debug the network setup and to discover what network traffic is reaching the appliance or leaving the appliance.

Packet Capture

Current Packet Capture

No packet capture in progress

[Start Capture](#)

Manage Packet Capture Files

<i>S10-005056040101-vmware-20080428-131029.cap (24B)</i>	▲
<i>S10-005056040101-vmware-20080428-130812.cap (58K)</i>	▼
<i>S10-005056040101-vmware-20080428-130537.cap (13K)</i>	▼
<i>S10-005056040101-vmware-20080428-125425.cap (24B)</i>	▼

[Delete Selected Files](#)
[Download File](#)

Packet Capture Settings

Capture File Size Limit:	200 MB
Capture Duration:	Run Capture Indefinitely
Interfaces Selected:	Management
Filters Selected:	(tcp port 80 or tcp port 3128)

[Edit Settings...](#)

The appliance saves the captured packet activity to a file and stores the file locally. You can configure the maximum packet capture file size, how long to run the packet capture, and on which network interface to run the capture. You can also use a filter to limit the number of packets seen by the packet capture which can make the output more usable on networks with a high volume of traffic. You can send any stored packet capture file using FTP to IronPort Customer Support for debugging and troubleshooting purposes.

The Support and Help > Packet Capture page displays the list of complete packet capture files stored on the hard drive. When a packet capture is running, the web interface shows the status of the capture in progress by showing the current statistics, such as file size and time elapsed.

You can download the packet capture files using the **Download** button in the web interface, or by connecting to the appliance using FTP and retrieving them from the captures directory.

In the CLI, use the `packetcapture` command.

In the web interface, select the Packet Capture option under the Support and Help menu.

Note — The packet capture feature is similar to the Unix `tcpdump` command.

Starting a Packet Capture

To start a packet capture in the CLI, run the `packetcapture > start` command. If you need to stop a running packet capture, run the `packetcapture > stop` command.

To start a packet capture in the web interface, select the Packet Capture option under the Support and Help menu, and then click **Start Capture**. To stop a running capture, click **Stop Capture**.

Note — The web interface only displays packet captures started in the web interface, not from the CLI. Similarly, the CLI only displays the status of a current packet capture run started in the CLI.

Editing Packet Capture Settings

To edit the packet capture settings in the CLI, run the `packetcapture > setup` command.

To edit packet capture settings in the web interface, select the Packet Capture option under the Support and Help menu, and then click **Edit Settings**.

Table 23-1 describes the packet capture settings you can configure.

Table 23-1 Packet Capture Configuration Options

Option	Description
Capture file size limit	The maximum file size for all packet capture files.
Capture duration	<p>Choose how long to run the packet capture:</p> <ul style="list-style-type: none"> • Run Capture Until File Size Limit Reached. The packet capture runs until the file size limit is reached. • Run Capture Until Time Elapsed Reaches. The packet capture runs until the configured time has passed. You can enter the time in seconds (s), minutes (m), or hours (h). If you enter the amount of time without specifying the units, AsyncOS uses seconds by default. <ul style="list-style-type: none"> Note: If the file reaches the maximum size limit before the entire time has elapsed, the existing file is deleted (the data is discarded) and a new file starts with the current packet capture data. • Run Capture Indefinitely. The packet capture runs until you manually stop it. <ul style="list-style-type: none"> Note: If the file reaches the maximum size limit before you manually stop the packet capture, the existing file is deleted (the data is discarded) and a new file starts with the current packet capture data. <p>You can always manually stop any packet capture.</p>
Network interface to capture	Select the network interface on which to run the packet capture.
Filters	<p>Choose whether or not to apply a filter to the packet capture to reduce the amount of data stored in the packet capture.</p> <p>You can use one of the predefined filters to filter by port, source IP address, or destination IP address, or you can create a custom filter using any syntax supported by the Unix <code>tcpdump</code> command.</p>

Note — When you change the packet capture settings without committing the changes and then start a packet capture, AsyncOS uses the new settings. This allows you to use the new settings in the current session without enforcing the settings for future packet capture runs. The settings remain in effect until you clear them.

Figure 23-3 on page 514 shows where you can edit the packet capture settings in the web interface.

Figure 23-3 Editing Packet Capture Settings in the Web Interface

Edit Packet Capture Settings

Packet Capture Settings	
Capture File Size Limit: ?	<input type="text" value="200"/> MB <i>Maximum file size is 200MB</i>
Capture Duration:	<input type="radio"/> Run Capture Until File Size Limit Reached <input type="radio"/> Run Capture Until Time Elapsed Reaches <input type="text" value=""/> (e.g. 120s, 5m 30s, 4h) <input checked="" type="radio"/> Run Capture Indefinitely <i>The capture can be ended manually at any time; use the settings above to specify whether the capture should end automatically.</i>
Interfaces:	<input checked="" type="checkbox"/> Management <input type="checkbox"/> T1 <input type="checkbox"/> T2
Packet Capture Filters	
Filters:	<i>All filters are optional. Fields are not mandatory.</i> <input type="radio"/> No Filters <input checked="" type="radio"/> Predefined Filters Ports: <input type="text" value="80,3128"/> Source IP: <input type="text"/> Destination IP: <input type="text"/> <input type="radio"/> Custom Filter ? <input type="text"/>

WORKING WITH FEATURE KEYS

Occasionally, your support team may provide a key to enable specific functionality on your system. Use the System Administration > Feature Keys page in the web interface (or the `featurekey` command in the CLI) to enter the key and enable the associated functionality.

Keys are specific to the serial number of your appliance and specific to the feature being enabled (you cannot re-use a key from one system on another system). If you incorrectly enter a key, an error message is generated.

Feature keys functionality is split into two pages: Feature Keys and Feature Key Settings.

Feature Keys Page

The Feature Keys page:

- Lists all active feature keys for the appliance.
- Shows any feature keys that are pending activation.
- Looks for new keys that have been issued (optional, and also can install keys).

A list of the currently enabled features is displayed. The Pending Activation section is a list of feature keys that have been issued for the appliance but have not yet been activated. Your appliance may check periodically for new keys depending on your configuration. You can click **Check for New Keys** to refresh the list of pending keys.

Figure 23-4 The Feature Keys Page

Feature Keys

Feature Keys for Serial Number: 005056040101-vmware			
Description	Status	Time Remaining	Expiration Date
IronPort Web Proxy & DVS™ Engine	Active	84 days	Thu Jul 17 04:06:44 2008
IronPort L4 Traffic Monitor	Active	84 days	Thu Jul 17 04:06:44 2008
IronPort Web Reputation Filters	Active	84 days	Thu Jul 17 04:06:44 2008
IronPort URL Filtering	Active	84 days	Thu Jul 17 04:06:44 2008
McAfee	Active	84 days	Thu Jul 17 04:06:44 2008
IronPort HTTPS Proxy	Active	85 days	Fri Jul 18 04:13:22 2008
Webroot	Active	84 days	Thu Jul 17 04:06:44 2008
Pending Activation			
No feature key activations are pending.			
			Check for New Keys

Feature Activation	
Feature Key:	<input type="text"/>
Submit Key	

You can also use the `featurekey` CLI command to accomplish the same tasks as on the Feature Keys page.

Feature Key Settings Page

The Feature Key Settings page is used to control whether your appliance checks for and downloads new feature keys, and whether or not those keys are automatically activated.

Figure 23-5 The Feature Key Settings Page

Feature Key Settings

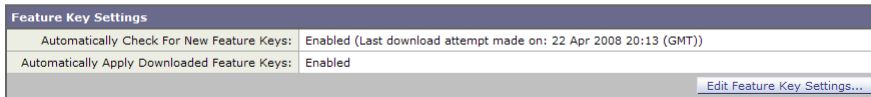

Feature Key Settings	
Automatically Check For New Feature Keys:	Enabled (Last download attempt made on: 22 Apr 2008 20:13 (GMT))
Automatically Apply Downloaded Feature Keys:	Enabled

To add a new feature key manually, paste or type the key into the Feature Key field and click **Submit Key**. An error message is displayed if the feature is not added (if the key is incorrect, etc.), otherwise the feature key is added to the display.

To activate a new feature key from the Pending Activation list, select the key (mark the “Select” checkbox) and click **Activate Selected Keys**.

You can configure your IronPort appliance to automatically download and install new keys as they are issued. In this case, the Pending Activation list will always be empty. You can tell AsyncOS to look for new keys at any time by clicking the **Check for New Keys** button, even if you have disabled the automatic checking via the Feature Key Settings page.

You can also use the `featurekeyconfig` CLI command to accomplish the same tasks as on the Feature Key Settings page.

Expired Feature Keys

If the feature key for the feature you are trying to access (via the web interface) has expired, please contact your IronPort representative or support organization.

ADMINISTERING USER ACCOUNTS

The following types of users can log into the Web Security appliance to manage the appliance:

- **Local users.** You can define users locally on the appliance itself. For more information, see “Managing Local Users” on page 517.
- **Users defined in an external system.** You can configure the appliance to connect to an external RADIUS server to authenticate users logging into the appliance. For information, see “Using External Authentication” on page 520.

You can manage local users and connections to external authentication servers using the System Administration > Users page in the web interface, or the `userconfig` command in the CLI.

Figure 23-6 shows where you manage local users and external authentication.

Figure 23-6 System Administration > Users Page

Users

Users			
Add User...			
User Name	Full Name	User Type	Delete
admin	Administrator	Administrator	

External Authentication	
External Authentication is disabled.	
Enable...	

Note — Any user you define can log into the appliance using any method, such as logging into the web interface or using SSH.

Managing Local Users

You can define any number users locally on the Web Security appliance. You can add, edit, and delete local users. Consider the following rules when defining local users:

- User names can contain lowercase letters, numbers, and the dash (-) character.
- User names cannot start with a dash.
- User names cannot be longer than 16 characters.
- Passwords must be at least 6 characters long.
- User names cannot be special names that are reserved by the system, such as “operator” or “root.”

The default system admin account has all administrative privileges. You can change the admin account password, but you cannot edit or delete this account.

To create a new user account, specify a user name and a full name, and then assign the user to a group. Each group provides a different level of default permissions. Table 23-2 lists the groups you can assign.

Table 23-2 User Groups

Group	Description
Administrator	The administrators group allows full access to all system configuration settings. However, the <code>upgradecheck</code> and <code>upgradeinstall</code> commands can be issued only from the system defined "admin" account.
Operator	The operators group restricts users from creating, editing, or removing user accounts. The operators group also restricts the use of the following commands: <ul style="list-style-type: none"> • <code>resetconfig</code> • <code>upgradecheck</code> • <code>upgradeinstall</code> • <code>systemsetup</code> or running the System Setup Wizard
Guest	The guests group users can only view system status information.

After assigning the user to a group, you must specify a password for the new account. Passwords are encrypted when they are reported using the `showconfig` CLI command.

Note — If you have lost the admin user password, contact your support provider.

Adding Local Users

To add a local user:

1. On the System Administration > Users page, click **Add User**.

The Add Local User page is displayed.

Figure 23-7 Adding a Local User

Add Local User

The screenshot shows a web form titled "Local User Settings". It has the following fields and options:

- User Name:** A text input field.
- Full Name:** A text input field.
- User Type:** A radio button selection with three options: "Administrator" (selected), "Operator", and "Guest".
- Password:** A text input field.
- Retype Password:** A text input field.

2. Enter a name for the user. Some words are reserved, such as "operator" and "root".
3. Enter a full name for the user.

4. Select a user type. See Table 23-2, “User Groups,” on page 518 for more information about user types.
5. Enter a password and retype it.
6. Submit and commit your changes.

Deleting Users

To delete a user:

1. On the System Administration > Users page, click the trash can icon corresponding to the listed user name.
2. Confirm the deletion by clicking **Delete** in the warning dialog that appears.
3. Submit and commit your changes.

Editing Users

To edit a user:

1. On the System Administration > Users page, click the user name.
The Edit User page is displayed.
2. Make changes to the user.
3. Submit and commit your changes.

Changing Passwords

Users can change their own passwords using the Change Password option under the Options menu located on the top right-hand side of the web interface.

Figure 23-8 shows where you can change the current user password.

Figure 23-8 The Change Password Option

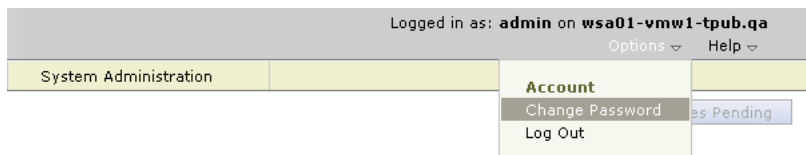

Note — To change the password for the admin account, use the System Administration > Users page or use the `password` or `passwd` command in the CLI. Password changes take effect immediately and do not require a commit.

Monitoring Users from the CLI

The `who`, `whoami`, and `last` commands can be used to monitor user access to the appliance.

- The `who` command lists users, the time of login, idle time, and the remote host from which the user is logged in:

```
example.com> who

Username  Login Time  Idle Time  Remote Host  What
=====  =====  =====  =====  =====
admin    03:27PM    0s        10.xx.xx.xx  cli
```

- The `whoami` command displays the user name and group information:

```
example.com> whoami

Username: admin
Full Name: Administrator
Groups: admin, operators, config, log, guest
```

- The `last` command displays information about users who have recently logged into the appliance.

```
example.com> last

Username  Remote Host  Login Time          Logout Time          Total Time
=====  =====  =====  =====  =====
admin    10.xx.xx.xx  Sat May 15 23:42    still logged in     15m
admin    10.xx.xx.xx  Sat May 15 22:52    Sat May 15 23:42    50m
admin    10.xx.xx.xx  Sat May 15 11:02    Sat May 15 14:14    3h 12m
admin    10.xx.xx.xx  Fri May 14 16:29    Fri May 14 17:43    1h 13m
shutdown                               Fri May 14 16:22
```

Using External Authentication

If you store user information in a RADIUS directory on your network, you can configure the Web Security appliance to use the RADIUS directory to authenticate users logging in to the appliance. You can use external authentication when logging into the appliance using HTTP, HTTPS, SSH, and FTP. To set up the appliance to use an external directory for authentication, use the System Administration > Users page in the web interface or the `userconfig > external` CLI command.

Figure 23-9 shows where you enable external authentication on the System Administration > Users page.

Figure 23-9 Enabling External Authentication



You can configure the appliance to contact multiple external servers for authentication. You might want to define multiple external servers to allow for failover in case one server is temporarily unavailable. When you define multiple external servers, the appliance connects to the servers in the order defined on the appliance.

When external authentication is enabled and a user logs into the Web Security appliance, the appliance first determines if the user is the system defined “admin” account. If not, then the appliance checks the first configured external server to determine if the user is defined there. If the appliance cannot connect to the first external server, the appliance checks the next external server in the list. If the user fails authentication on any external server, the appliance tries to authenticate the user as a local user defined on the Web Security appliance. If the user does not exist on any external server or on the appliance, or if the user enters the wrong password, access to the appliance is denied.

Note — AsyncOS for Web connects to the external server over the M1 interface only.

The Web Security appliance assigns all users in the RADIUS directory to the administrator user group. You cannot assign users to other user groups. When external authentication is enabled and a user successfully authenticates as a local user, the local user has Administrator user group privileges regardless of the configured user type.

To enable external authentication using RADIUS:

1. On the System Administration > Users page, click **Enable**.
The Edit External Authentication page is displayed.
2. Enable the **Enable External Authentication** option if it is not enabled already.

Figure 23-10 Enabling External Authentication Using RADIUS

Edit External Authentication

External Authentication Settings						
<input checked="" type="checkbox"/> Enable External Authentication						
Authentication Type:		RADIUS				
RADIUS Server Information:		RADIUS Server Hostname	Port	Shared Secret	Timeout Value (in seconds)	<input type="button" value="Add Row"/>
		<input type="text"/>	1812	<input type="text"/>	5	<input type="button" value="X"/>
External Authentication Cache Timeout: ?		<input type="text" value="0"/> seconds				
Group Mapping:		Administrator				
<small>When RADIUS external authentication is enabled, all authenticated users map to the administrator role. This includes users that have been authenticated locally due to RADIUS failures.</small>						

3. Enter the host name for the RADIUS server.
4. Enter the port number for the RADIUS server. The default port number is 1812.
5. Enter the Shared Secret password for the RADIUS server.
6. Enter the number of seconds for the appliance to wait for a response from the server before timing out.

7. Optionally, click **Add Row** to add another RADIUS server. Repeat steps 3-6 for each RADIUS server.

Note — You can add up to ten RADIUS servers.

8. Enter the number of seconds AsyncOS stores the external authentication credentials before contacting the RADIUS server again to authenticate again in the “External Authentication Cache Timeout” field. Default is zero (0).

Note — If the RADIUS server uses one-time passwords, for example passwords created from a token, enter zero (0). When the value is set to zero, AsyncOS does not contact the RADIUS server again to authenticate during the current session.

9. Submit and commit your changes.

CONFIGURING ADMINISTRATOR SETTINGS

You can configure the Web Security appliance to have stricter access requirements for administrators logging into the appliance. You might want to do this to meet certain organization requirements.

You configure these settings with the `adminaccessconfig` CLI command. You can configure the appliance to:

- Display user-defined text at administrator login.
- Restrict administrator access to certain machines.
- Require stronger SSL ciphers for administrator access.

Configuring Custom Text at Login

Using the `adminaccessconfig > banner` CLI command, you can configure the appliance to display any text you specify when an administrator tries to log in. You might want to do this to display a banner that informs the user of organizational policies and conditions. The custom banner text appears when an administrator tries to access the appliance through all interfaces, such as the web interface or via FTP.

You can load the custom text by either pasting it into the CLI prompt or by copying it from a file located on the Web Security appliance. To upload the text from a file, you must first transfer the file to the configuration directory on the appliance using FTP.

Configuring IP-Based Administrator Access

Using the `adminaccessconfig > ipaccess` CLI command, you can control from which IP addresses administrators access the Web Security appliance. Administrators can access the appliance from any machine or from machines with an IP address from a list you specify.

When restrict access to an allow list, you can specify IP addresses, subnets, or CIDR addresses.

By default, when you list the addresses that can access the appliance, the IP address of your current machine is listed as the first address in the allow list. You cannot delete the IP address of your current machine from the allow list.

Configuring the SSL Ciphers for Administrator Access

Using the `adminaccessconfig > strictssl` CLI command, you can configure the appliance so administrators log into the web interface on port 8443 using stronger SSL ciphers (greater than 56 bit encryption).

When you configure the appliance to require stronger SSL ciphers, the change only applies to administrators accessing the appliance using HTTPS to manage the appliance. It does not apply to other network traffic connected to the Web Proxy using HTTPS.

CONFIGURING THE RETURN ADDRESS FOR GENERATED MESSAGES

You can configure the return address for mail generated by AsyncOS for reports. You can specify the display, user, and domain names of the return address. You can also choose to use the Virtual Gateway domain for the domain name.

Configure the return address on the System Administration > Return Addresses page.

Figure 23-11 Configuring Return Addresses

Return Addresses



Return Addresses for System-Generated Email

Reports: "IronPort Reporting" <reporting@hostname>

Edit Settings...

To configure the return address for system-generated email messages:

1. Navigate to the System Administration > Return Addresses page.
2. Click **Edit Settings**.

Figure 23-12 Editing Return Address Settings

Edit Return Addresses

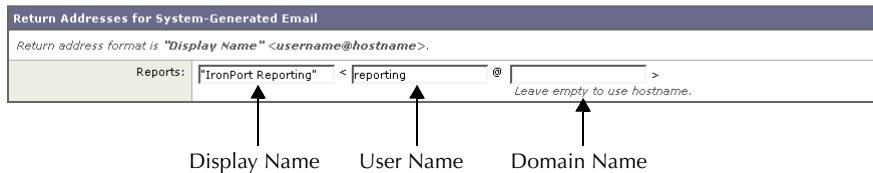

Return Addresses for System-Generated Email

Return address format is "Display Name" <username@hostname>.

Reports: "IronPort Reporting" <reporting @ >

Leave empty to use hostname.

Display Name User Name Domain Name

3. For Reports, enter the display name, user name, and domain name in the fields shown in Figure 23-12.
4. Submit and commit your changes.

MANAGING ALERTS

Alerts are email notifications containing information about events occurring on the IronPort appliance. These events can be of varying levels of importance (or severity) from minor (Informational) to major (Critical) and pertain generally to a specific component or feature on the appliance. Alerts are generated by the IronPort appliance. You can specify which alert messages are sent to which users and for which severity of event they are sent. Manage alerts using the System Administration > Alerts page in the web interface or using the `alertconfig` command in the CLI.

Note — To receive alerts and email notifications, you must configure the SMTP relay host that the appliance uses to send the email messages. For information about configuring the SMTP relay host, see “Configuring SMTP Relay Hosts” on page 502.

Alerting Overview

The alerting feature consists of two main parts:

- **Alerts** - consist of an Alert **Recipient** (email addresses for receiving alerts), and the alert notification (severity and alert type) sent to the recipient.
- **Alert Settings** - specify global behavior for the alerting feature, including alert sender (FROM:) address, seconds to wait between sending duplicate alerts, and whether to enable AutoSupport (and optionally send weekly AutoSupport reports).

Alerts: Alert Recipients, Alert Classifications, and Severities

Alerts are email messages or notifications containing information about a specific function (or alert classification) or functions such as a hardware or anti-virus problem, sent to an alert-recipient. An alert recipient is simply an email address to which the alert notifications are sent. The information contained in the notification is determined by an alert classification and a severity. You can specify which alert classifications, at which severity, are sent to any alert recipient. The alerting engine allows for granular control over which alerts are sent to which alert recipients. For example, you can configure the system to send only specific alerts to an alert recipient, configuring an alert recipient to receive notifications only when Critical (severity) information about the System (alert type) is sent. You can also configure general settings (see “Configuring Alert Settings” on page 531).

Alert Classifications

AsyncOS sends the following alert classifications:

Table 23-3 Alert Classifications and Components

Alert Classification	Alert Component
System	System
Hardware	Hardware

Table 23-3 Alert Classifications and Components (Continued)

Alert Classification	Alert Component
Updater	Updater
Web Proxy	Proxy
DVS™ and Anti-Malware	DVS
L4 Traffic Monitor	TrafMon

Severities

Alerts can be sent for the following severities:

- Critical: Requires immediate attention.
- Warning: Problem or error requiring further monitoring and potentially immediate attention.
- Information: Information generated in the routine functioning of this device.

Alert Settings

Alert settings control the general behavior and configuration of alerts, including:

- The RFC 2822 Header From: when sending alerts (enter an address or use the default “alert@<hostname>”). You can also set this via the CLI, using the `alertconfig -> from` command.
- The initial number of seconds to wait before sending a duplicate alert.
- The maximum number of seconds to wait before sending a duplicate alert.
- The status of AutoSupport (enabled or disabled).
- The sending of AutoSupport’s weekly status reports to alert recipients set to receive System alerts at the Information level.

Sending Duplicate Alerts

You can specify the initial number of seconds to wait before AsyncOS will send a duplicate alert. If you set this value to 0, duplicate alert summaries are not sent and instead, all duplicate alerts are sent without any delay (this can lead to a large amount of email over a short amount of time). The number of seconds to wait between sending duplicate alerts (alert interval) is increased after each alert is sent. The increase is the number of seconds to wait plus twice the last interval. So a 5 second wait would have alerts sent at 5 seconds, 15, seconds, 35 seconds, 75 seconds, 155 seconds, 315 seconds, etc.

Eventually, the interval could become quite large. You can set a cap on the number of seconds to wait between intervals via the maximum number of seconds to wait before sending a duplicate alert field. For example, if you set the initial value to 5 seconds, and the maximum

value to 60 seconds, alerts would be sent at 5 seconds, 15 seconds, 35 seconds, 60 seconds, 120 seconds, etc.

IronPort AutoSupport

To allow IronPort to better support and design future system changes, the IronPort appliance can be configured to send IronPort Systems a copy of all alert messages generated by the system. This feature, called AutoSupport, is a useful way to allow our team to be proactive in supporting your needs. AutoSupport also sends weekly reports noting the uptime of the system, the output of the `status` command, and the AsyncOS version used.

By default, alert recipients set to receive Information severity level alerts for System alert types will receive a copy of every message sent to IronPort. This can be disabled if you do not want to send the weekly alert messages internally. To enable or disable this feature, see “Configuring Alert Settings” on page 531.

Alert Messages

Alert messages are standard email messages. You can configure the Header From: address, but the rest of the message is generated automatically.

Alert From Address

You can configure the Header From: address via the **Edit Settings...** button or via the CLI.

Alert Subject

An alert email message's subject follows this format:

```
Subject: [severity]-[hostname]: ([class]) short message
```

Example Alert Message

```
Date: 23 May 2007 21:10:19 +0000
To: joe@example.com
From: IronPort S650 Alert [alert@example.com]
Subject: Critical <System> example.com: Internal SMTP giving up on
message to jane@company.com with...
```

The Critical message is:

```
Internal SMTP giving up on message to jane@company.com with subject
'IronPort Report: Client Web Activity (example.com)': Unrecoverable
error.
```

```
Product: IronPort S650 Web Security Appliance
Model: S650
Version: 5.1.0-225
Serial Number: XXXXXXXXXXXXX-XXXXXXX
Timestamp: Tue May 10 09:39:24 2007
```

For more information about this error, please see
<http://support.ironport.com>

If you desire further information, please contact your support
provider.

Managing Alert Recipients

Log in to the S-Series appliance web interface (GUI) and click the System Administration tab. Click the Alerts link in the left menu. For information about how to access the S-Series appliance web interface, see “Accessing the Web Security Appliance” on page 17.

Figure 23-13 The Alerts Page

Alerts

Success — The recipient has been saved.

Alert Recipients							
Add Recipient...							
Recipient Address	System	Hardware	Updater	Web Proxy	DVS and Anti-Malware	L4 Traffic Monitor	Delete
jane@example.com	All	Critical Warning	Critical	Critical	Critical Warning	Critical	

Alert Settings	
From Address to Use When Sending Alerts:	Automatically Generated
Initial Number of Seconds to Wait Before Sending a Duplicate Alert:	300
Maximum Number of Seconds to Wait Before Sending a Duplicate Alert:	3600
IronPort AutoSupport:	Disabled

[Edit Settings...](#)

Note — If you enabled AutoSupport during System Setup, the email address you specified will receive alerts for all severities and classes by default. You can change this configuration at any time.

The Alerts page lists the existing alert recipients and alert settings.

From the Alerts page, you can:

- Add, configure, or delete alert recipients
- Modify the alert settings

Adding New Alert Recipients

To add a new alert recipient:

1. Click **Add Recipient...** on the Alerts page. The Add Alert Recipients page is displayed:

Figure 23-14 Adding a New Alert Recipient

Add Alert Recipient

Alert Recipient				
Recipient Address:	<input type="text"/>			
	<i>Separate multiple email addresses with commas</i>			
	Alert Severities to Receive			
	All	Critical ?	Warning ?	Info ?
Alert Type	<input type="checkbox"/>	<input type="checkbox"/>	<input type="checkbox"/>	<input type="checkbox"/>
System	<input type="checkbox"/>	<input type="checkbox"/>	<input type="checkbox"/>	<input type="checkbox"/>
Hardware	<input type="checkbox"/>	<input type="checkbox"/>	<input type="checkbox"/>	<input type="checkbox"/>
Updater	<input type="checkbox"/>	<input type="checkbox"/>	<input type="checkbox"/>	<input type="checkbox"/>
Web Proxy	<input type="checkbox"/>	<input type="checkbox"/>	<input type="checkbox"/>	<input type="checkbox"/>
DVS and Anti-Malware	<input type="checkbox"/>	<input type="checkbox"/>	<input type="checkbox"/>	<input type="checkbox"/>
L4 Traffic Monitor	<input type="checkbox"/>	<input type="checkbox"/>	<input type="checkbox"/>	<input type="checkbox"/>

2. Enter the recipient's email address. You can enter multiple addresses, separated by commas.
3. Select which alert severities to receive.
4. Click **Submit** to add the alert recipient.
5. Click the **Commit Changes** button, add an optional comment if necessary, then click **Commit Changes** to save the changes.

Configuring Existing Alert Recipients

To edit an existing alert recipient:

1. Click the alert recipient in the Alert Recipients listing. The Configure Alert Recipient page is displayed.
2. Make changes to the alert recipient.
3. Click **Submit** to edit the alert recipient.
4. Click the **Commit Changes** button, add an optional comment if necessary, then click **Commit Changes** to save the changes.

Deleting Alert Recipients

To delete an alert recipient:

1. Click the trash can icon corresponding to the alert recipient in the Alert Recipient listing.
2. Confirm the deletion by clicking **Delete** in the warning dialog that appears.
3. Click the **Commit Changes** button, add an optional comment if necessary, then click **Commit Changes** to save the changes.

Configuring Alert Settings

Alert settings are global settings, meaning that they affect how all of the alerts behave.

Editing Alert Settings

To edit alert settings:

1. Click **Edit Settings...** on the Alerts page. The Edit Alert Settings page is displayed:

Figure 23-15 Editing Alert Settings

Edit Alert Settings

Alert Settings	
From Address to Use When Sending Alerts:	<input type="radio"/> <input type="text"/> <input checked="" type="radio"/> Automatically generated <i>(example: IronPort Alert <alert@host.example.com>.)</i>
Wait Before Sending a Duplicate Alert:	<input checked="" type="checkbox"/> Enable
	<input type="text" value="300"/> Initial Number of Seconds to Wait Before Sending a Duplicate Alert
	<input type="text" value="3600"/> Maximum Number of Seconds to Wait Before Sending a Duplicate Alert
IronPort AutoSupport:	<input type="checkbox"/> Enable
	<input checked="" type="checkbox"/> Send copy of weekly AutoSupport reports to System Information Alert recipients.

2. Enter a Header From: address to use when sending alerts, or select Automatically Generated (“alert@<hostname>”).
3. Mark the checkbox if you want to specify the number of seconds to wait between sending duplicate alerts. For more information, see “Sending Duplicate Alerts” on page 526.
 - Specify the initial number of seconds to wait before sending a duplicate alert.
 - Specify the maximum number of seconds to wait before sending a duplicate alert.
4. You can enable AutoSupport by checking the IronPort AutoSupport option. For more information about AutoSupport, see “IronPort AutoSupport” on page 527.
 - If AutoSupport is enabled, the weekly AutoSupport report is sent to alert recipients set to receive System alerts at the Information level. You can disable this via the checkbox.
5. Click **Submit** to edit the alert settings.
6. Click the **Commit Changes** button, add an optional comment if necessary, then click **Commit Changes** to save the changes.

SETTING SYSTEM TIME

To set the system time on your Web Security appliance, set the time zone used, or select an NTP server and query interface. To set the system time, use the System Administration > Time Zone or Time Settings page or use the `ntpconfig`, `settime`, and `settz` commands.

Selecting a Time Zone

To set the time zone use the System Administration > Time Zone page:

Figure 23-16 The Time Zone Page

Edit Time Zone

Time Zone Setting	
Time Zone:	Region: GMT Offset ▾
	Country: GMT ▾
	Time Zone: GMT (GMT) ▾

Select a time zone in the Time Zone area. You can configure the time zone by specifying the region and country, or by using a GMT offset.

The web interface uses the POSIX-style method of indicating the time zone using a GMT offset. This may be different than the offset convention used elsewhere.

The offset refers to the amount of hours that must be added or subtracted to the local time zone in order to reach GMT (Greenwich Mean Time or the Prime Meridian). Hours preceded by a minus sign (“-”) are *east* of the Prime Meridian. A plus sign (“+”) indicates *west* of the Prime Meridian.

For example, if the current time in New York is 08:00, then you must add five hours to get the current time in Greenwich, England, which is 13:00. In this case, to indicate the time in New York, the GMT offset is GMT+5. The “+5” in the offset indicates that you must add five hours to the time in New York to reach Greenwich Mean Time.

Editing System Time

To edit system time, use the System Administration > Time Settings page.

Figure 23-17 The Edit Time Settings Page

Edit Time Settings

The screenshot shows the 'Time Settings' configuration page. It has a title bar 'Time Settings' and a left sidebar. The main content area is divided into two sections by radio buttons. The first section, 'Use Network Time Protocol', is selected. It contains a table for NTP servers with one row containing 'time.ironport.com' and an 'Add Row' button. Below the table is a dropdown menu for 'Routing Table for NTP Server Queries' set to 'Management'. The second section, 'Set Time Manually', is unselected and contains a 'Local Time' field with input boxes for MM, DD (27), YY (009), HH (10), MM (0), SS (5), and a PM/AM dropdown. A note at the bottom states: 'Note: manual time set will take place immediately when the Submit button is clicked — it is not necessary to "commit" these changes.'

Configure NTP (Network Time Protocol)

To edit NTP server settings and use an NTP server to synchronize the system clock with other computers:

1. Enter an NTP server IP address and use the Add Row key to repeat as necessary for each NTP server.
2. Choose the routing table associated with an appliance network interface type, either Management or Data, to use for NTP queries. This is the IP address from which NTP queries should originate.
3. Submit and commit the changes.

Manually Setting System Time

To set the system time manually:

1. Select Set Time Manually.
2. Enter the month, day, year, hour, minutes, and seconds.
3. Select A.M or P.M.
4. Submit and commit to save the changes.

INSTALLING A SERVER DIGITAL CERTIFICATE

When an administrator logs into the Web Security appliance using HTTPS, the appliance uses a digital certificate to securely establish the connection with the client application. The Web Security appliance uses the “IronPort Appliance Demo Certificate” that comes installed by default. However, client applications are not programmed to recognize this certificate, so you can upload a digital certificate to the appliance that your applications recognize automatically.

Figure 23-18 shows the warning message that is displayed in Firefox when accessing the Web Security appliance using the IronPort Appliance Demo Certificate.

Figure 23-18 IronPort Appliance Demo Certificate as an Unknown Authority



To configure the Web Security appliance to use a different digital server certificate, follow these steps:

1. Obtain a certificate and private key pair to upload. For more information, see “Obtaining Certificates” on page 534.
2. Upload the certificate and private key pair to the appliance. For more information, see “Uploading Certificates to the Web Security Appliance” on page 535.

Obtaining Certificates

To obtain a digital certificate to upload to the appliance, you must follow these steps:

1. Generate a public-private key pair.
2. Generate a Certificate Signing Requests (CSR).
3. Contact a certificate authority (CA) to sign the certificate.

The certificate you upload to the appliance must meet the following requirements:

- It must use the X.509 standard.
- It must include a matching private key in PEM format. DER format is not supported.
- The private key must be unencrypted.

The Web Security appliance cannot generate Certificate Signing Requests (CSR). Therefore, to have a certificate created for the appliance, you must issue the signing request from another system. Save the PEM-formatted key from this system because you will need to install it on the appliance later.

You can use any UNIX machine with a recent version of OpenSSL installed. Be sure to put the appliance host name in the CSR. Use the guidelines at the following location for information on generating a CSR using OpenSSL:

http://www.modssl.org/docs/2.8/ssl_faq.html#ToC28

Once the CSR has been generated, submit it to a certificate authority (CA). The CA will return the certificate in PEM format.

If you are acquiring a certificate for the first time, search the Internet for “certificate authority services SSL server certificates,” and choose the service that best meets the needs of your organization. Follow the service’s instructions for obtaining an SSL certificate.

Note — You can also generate and sign your own certificate. Tools for doing this are included with OpenSSL, free software from <http://www.openssl.org>.

Intermediate Certificates

In addition to root certificate authority (CA) certificate verification, AsyncOS supports the use of intermediate certificate verification. Intermediate certificates are certificates issued by a trusted root CA which are then used to create additional certificates. This creates a chained line of trust. For example, a certificate may be issued by example.com who, in turn, is granted the rights to issue certificates by a trusted root CA. The certificate issued by example.com must be validated against example.com’s private key as well as the trusted root CA’s private key.

Uploading Certificates to the Web Security Appliance

To upload a digital certificate to the Web Security appliance, use the `certconfig` command.

The following example shows a certificate being uploaded. You can also add intermediate certificates from this command.

```
example.com> certconfig

Currently using the demo certificate/key for HTTPS management access.

Choose the operation you want to perform:
- SETUP - Configure security certificate and key.
```

```

[ ]> setup

Management (HTTPS):
paste cert in PEM format (end with '.'):
-----BEGIN CERTIFICATE-----
MIICLDCCAdYCAQAwDQYJKoZIhvcNAQEEBQAwwAxCzAJBgNVBAYTAlBUMRMwEQYD
VQOIEwRdWVlbnNsYW5kMQ8wDQYDVQQHEwZMaXNib2ExFzAVBgNVBAoTDk5ldXJv
bmlvLlCBMzGZGEMRgwFgYDVQQLEw9EZXXNlbnZvbHJpbWVudG8xGzAZBgNVBAMTEmJy
dXR1cy5uZXVyb25pby5wdDEbMBkGCsGSIb3DQEJARYMc2FtcG9AaWtpLmZpMB4X
DTk2MDkwNTAzNDIOM1oXDk2MTAwNTAzNDIOM1owgaAxCzAJBgNVBAYTAlBUMRMw
EQYDVQOIEwRdWVlbnNsYW5kMQ8wDQYDVQQHEwZMaXNib2ExFzAVBgNVBAoTDk5l
dXJvbmlvLlCBMzGZGEMRgwFgYDVQQLEw9EZXXNlbnZvbHJpbWVudG8xGzAZBgNVBAMT
EmJydXR1cy5uZXVyb25pby5wdDEbMBkGCsGSIb3DQEJARYMc2FtcG9AaWtpLmZp
MFwwDQYJKoZIhvcNAQEBBQADSwAwSAJBAL7+aty3S1iBA/+yxjxv4q1MUTd1kjNw
L4lYKbpzlmC5beaQXeQ2RmGMTXU+mDvuqItjVHOK3DvPK7lTcSGftUCAwEAATAN
BgkqhkiG9w0BAQQAANBAFqPEKFjk6T6CKTHvaQeEAsX0/8YHPHQH/9AnhSjrWuX
9EBc0n6bVGHn7XaXd6sJ7dym9sbsWxb+pJdurnkxjx4=
-----END CERTIFICATE-----
.

paste key in PEM format (end with '.'):
-----BEGIN RSA PRIVATE KEY-----
MIIBPAIBAAJBAL7+aty3S1iBA/+yxjxv4q1MUTd1kjNwL4lYKbpzlmC5beaQXeQ
2RmGMTXU+mDvuqItjVHOK3DvPK7lTcSGftUCAwEAQJBALjkK+jc2+iihI98riEF
oudmknziSRTYjnwjx8mCoAjPWviB3c742eO3FG4/soi1jD9A5alihEOXFuzloenr
8IECIQD3B5+0l+68BA/6d76iUNqAAV8djGTzvxnCxyCnXPQyQIhAMXt4trUI3nc
a+U8YL2HPFA3gmhBsSICbq2OptOCnM7hAiEA6Xi3JIQECob8YwkJRj29DU3/4WYD7
WLPgsQpwo1GuSpECICGsnWH5oaeD9t9jbFoSfhJvv0IZmxdclpRcpslpeWBBAiEA
6/5B8J0GHdJq89FHwEG/H2eVVUYu5y/ad6sgcm+0Avg=
-----END RSA PRIVATE KEY-----
.

Do you want add an intermediate certificate? [N]> N

Currently using custom certificate/key for HTTPS management access.

Choose the operation you want to perform:
- SETUP - Configure security certificate and key.
[ ]>

example.com> commit

Please enter some comments describing your changes:
[ ]> Installed certificate and key for HTTPS management.

Changes committed: Fri Sep 26 17:59:53 2008 GMT

```

UPGRADING THE SYSTEM SOFTWARE

Upgrading AsyncOS for Web uses the following two step process:

1. **Configure the update and upgrade settings.** You can configure settings that affect how the Web Security appliance downloads the upgrade information. For example, you can choose from where to download the upgrade images and more. For more information, see “Configuring Upgrade and Service Update Settings” on page 539.
2. **Upgrade the system software.** After you configure the update and upgrade settings, upgrade the software on the appliance. For more information, see “Upgrading AsyncOS for Web from the Web Interface” on page 537 and “Upgrading AsyncOS for Web from the CLI” on page 538.

Consider the following guidelines when you upgrade AsyncOS for Web:

- Before you start the upgrade, save the XML configuration file off the Web Security appliance from the System Administration > Configuration File page or by using the `saveconfig` command. For more information, see “Managing the Appliance Configuration” on page 508.
- When upgrading, do not pause for long amounts of time at the various prompts. If the TCP session times out during the download, the upgrade may fail.
- Consider saving the configuration information to an XML file after the upgrade completes, too.

Upgrading AsyncOS for Web from the Web Interface

To upgrade AsyncOS after you configure the update and upgrade settings:

1. On the System Administration > Configuration File page, save the XML configuration file off the Web Security appliance.
2. On the System Administration > System Upgrade page, click **Available Upgrades**.

The Available Upgrades page is displayed.

Figure 23-19 The Available Upgrades Page

Available Upgrades

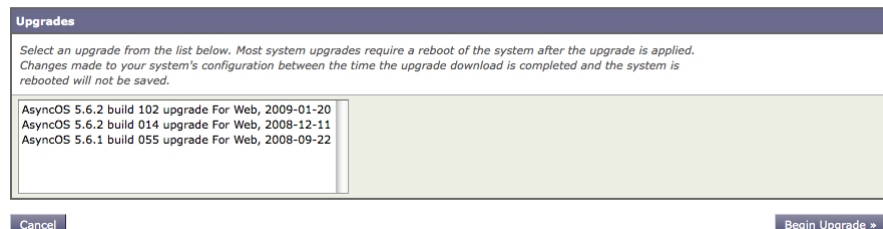

3. Select an upgrade from the list of available upgrades, and click **Begin Upgrade** to start the upgrade process. Answer the questions as they appear.
4. When the upgrade is complete, click **Reboot Now** to reboot the Web Security appliance.

Upgrading AsyncOS for Web from the CLI

Issue the `upgrade` command from the CLI to show a list of available upgrades. Select the desired upgrade from the list to install it. You may be asked to confirm messages or read and agree to license agreements, etc.

Differences from Traditional Upgrading Method

Please note these differences when upgrading AsyncOS from a local server as opposed to the traditional method:

1. The upgrading installs immediately *while downloading*.
2. A banner displays for 10 seconds at the beginning of the upgrade process. While this banner is displayed, you have the option to type Control+C to exit the upgrade process before downloading starts.

CONFIGURING UPGRADE AND SERVICE UPDATE SETTINGS

You can configure how the Web Security appliance downloads security services updates, such as Web Reputation Filters and AsyncOS for Web upgrades. For example, you can choose which network interface to use when downloading the files, configure the update interval, or disable automatic updates.

AsyncOS periodically queries the update servers for new updates to all security service components, but not for new AsyncOS upgrades. To upgrade AsyncOS, you must manually prompt AsyncOS to query for available upgrades. You can also manually prompt AsyncOS to query for available security service updates. For more information, see “Manually Updating Security Service Components” on page 545.

When AsyncOS queries an update server for an update or upgrade, it performs the following steps:

1. Contacts the update server.

IronPort allows the following sources for update servers:

- **IronPort update servers.** For more information, see “Updating and Upgrading from the IronPort Update Servers” on page 540.
 - **Local server.** For more information, see “Upgrading from a Local Server” on page 540.
2. Receives an XML file that lists the available updates or AsyncOS upgrade versions. This XML file is known as the “manifest.”
 3. Downloads the update or upgrade image files.

By default, AsyncOS contacts the IronPort update servers for both update and upgrade images and the manifest XML file. However, you can choose from where to download the upgrade and update images and the manifest file. You might want to specify a local update server for the images or manifest file for any of the following reasons:

- **You have multiple appliances to upgrade simultaneously.** If your organization has multiple Web Security appliances that need to upgrade, you can download the upgrade image to a web server inside your network and serve it to all appliances in your network.
- **Your firewall settings require static IP addresses for the IronPort update servers.** The IronPort update servers use dynamic IP addresses. If you have strict firewall policies, you may need to configure a static location for updates and AsyncOS upgrades. For more information, see “Configuring a Static Address for the IronPort Update Servers” on page 540.

Note — Only use a local update server for upgrade images, not update images. When you specify a local update server, the local server does not automatically receive updated security service updates from IronPort, so the appliances in your network eventually become out of date. Use a local update server for upgrading AsyncOS, and then change the update and upgrade settings back to use the IronPort update servers so the security services update automatically again.

You can configure upgrade and updates settings in the web interface or the CLI. For more information, see “Configuring the Update and Upgrade Settings from the Web Interface” on page 542 and “Configuring the Update and Upgrade Settings from the CLI” on page 545.

Figure 23-20 shows where you configure upgrade and update settings in the web interface.

Figure 23-20 System Administration > Upgrade and Update Settings Page

Upgrade and Update Settings

Update Settings for Security Services	
Update Server (list):	Dynamic (IronPort Update Server)
Update Server (images):	Dynamic (IronPort Update Server)
Automatic Updates:	Enabled
Update Interval:	5m
Routing Table:	Management
Proxy Server:	Not Enabled
Edit Update Settings...	

Updating and Upgrading from the IronPort Update Servers

The Web Security appliance can connect directly to the IronPort update servers and download upgrade images and security service updates. Each IronPort appliance downloads the updates and upgrade images separately.

IronPort Systems uses a distributed update server architecture to make sure customers can quickly download updates and AsyncOS upgrades wherever in the world they are located. Because of this distributed server architecture, the IronPort update servers use dynamic IP addresses. If you have strict firewall policies, you may need to configure a static location for AsyncOS upgrades. For more information, see “Configuring a Static Address for the IronPort Update Servers” on page 540.

Configuring a Static Address for the IronPort Update Servers

The IronPort update servers use dynamic IP addresses. If you have strict firewall policies, you may need to configure a static location for updates and AsyncOS upgrades. If you determine that your firewall settings require a static IP address for updates, complete the following steps:

1. Contact IronPort Customer support to obtain the static URL address.
2. Navigate to the System Administration > Upgrade and Update Settings page, and click **Edit Update Settings**.
3. On the Edit Update Settings page, in the “Update Servers (images)” section, choose Local Update Servers and enter the static URL address received in step 1.
4. Verify that IronPort Update Servers is selected for the “Update Servers (list)” section.
5. Submit and commit your changes.

Upgrading from a Local Server

The Web Security appliance can download AsyncOS upgrades from a server within your network instead of obtaining upgrades directly from the IronPort update servers. When you

use this feature, you only download the upgrade image from IronPort one time, and then serve it to all Web Security appliances in your network.

Figure 23-21 shows how Web Security appliances download upgrade images from local servers.

Figure 23-21 Upgrading from a Local Server

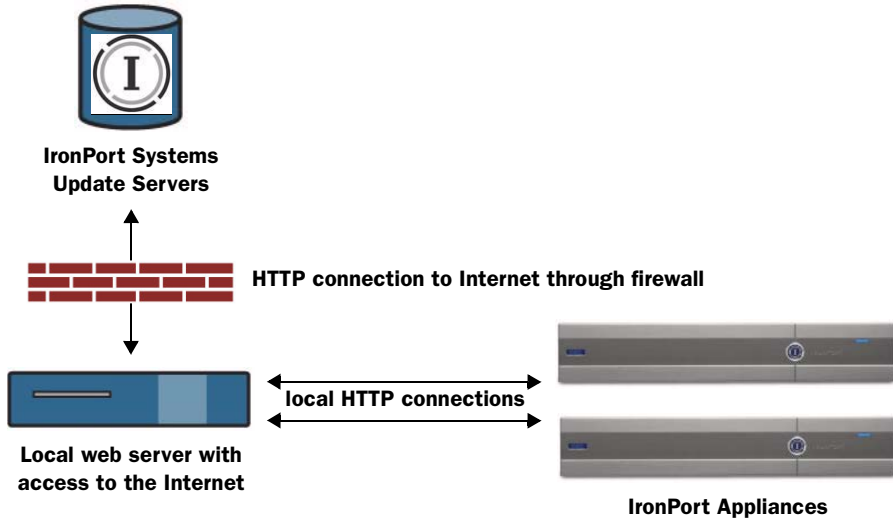

To upgrade from a local server, perform the following steps:

1. Configure a local server to retrieve and serve the upgrade files.
2. Download the upgrade zip file.

Using a browser on the local server, go to http://updates.ironport.com/fetch_manifest.html to download a zip file of an upgrade image. To download the image, enter your serial number and the version number of the IronPort appliance. You will then be presented with a list of available upgrades. Click on the upgrade version that you want to download.

3. Unzip the zip file in the root directory on the local server while keeping the directory structure intact.
4. Configure the appliance to use the local server using the System Administration > Upgrade and Update Settings page or the `updateconfig` command.
5. On the System Administration > System Upgrade page, click **Available Upgrades** or run the `upgrade` command.

Note — IronPort recommends changing the update and upgrade settings to use the IronPort update servers (using dynamic or static addresses) after the upgrade is complete to ensure the security service components continue to update automatically.

Hardware and Software Requirements for Local Upgrade Servers

For *downloading* AsyncOS upgrade files, you must have a system in your internal network that has a web browser (see “Browser Requirements” on page 21) and Internet access to the IronPort Systems update servers.

Note — If you need to configure a firewall setting to allow HTTP access to this address, you must configure it using the DNS name and not a specific IP address.

For *hosting* AsyncOS upgrade files, a server on the internal network must have a web server, such as Microsoft IIS (Internet Information Services) or the Apache open source server, which has the following features:

- Supports the display of directory or filenames in excess of 24 characters.
- Has directory browsing enabled.
- Is configured for anonymous (no authentication) or Basic (“simple”) authentication.
- Contains at least 350MB of free disk space for each AsyncOS upgrade image.

Configuring the Update and Upgrade Settings from the Web Interface

To edit the AsyncOS update and upgrade settings:

1. Navigate to the System Administration > Upgrade and Update Settings page, and click **Edit Update Settings**. The Edit Update Settings page is displayed.

Figure 23-22 on page 543 shows the options you can configure on the Edit Update Settings page.

Figure 23-22 Edit Update Settings Page

Edit Update Settings

Update Settings for Security Services	
Update Servers (images):	<p>The update servers will be used to obtain update images for the following services:</p> <ul style="list-style-type: none"> - Web Reputation Engine and Rules - DVS™ Engine - Webroot - L4 Traffic Monitor - IronPort URL Filters - IronPort AsyncOS upgrades <p><input checked="" type="radio"/> IronPort Update Servers</p> <p><input type="radio"/> Local Update Servers (location of update image files)</p> <p>Base Url: <input type="text" value="http://downloads.ironport.com/"/> Port: <input type="text" value="80"/> <input type="text" value="http://downloads.example.com"/></p> <p>Authentication (optional):</p> <p>Username: <input type="text"/></p> <p>Password: <input type="text"/></p> <p>Retype Password: <input type="text"/></p>
Update Servers (list):	<p>The URL will be used to obtain the list of available updates for the following services:</p> <ul style="list-style-type: none"> - Web Reputation Engine and Rules - McAfee - Webroot - L4 Traffic Monitor - IronPort URL Filters - IronPort AsyncOS upgrades <p><input checked="" type="radio"/> IronPort Update Servers</p> <p><input type="radio"/> Local Update Servers (location of list of available updates file)</p> <p>Full Url: <input type="text" value="http://updates.example.com/my_updates.xml"/> Port: <input type="text" value="80"/></p> <p>Authentication (optional):</p> <p>Username: <input type="text"/></p> <p>Password: <input type="text"/></p> <p>Retype Password: <input type="text"/></p>
Automatic Updates:	<p><input checked="" type="checkbox"/> Enable automatic updates (Not including IronPort AsyncOS)</p> <p>Update Interval: <input type="text" value="5m"/></p>
Routing Table:	<p><input type="text" value="Management"/></p>
Proxy Server (optional):	<p>If an HTTP proxy server is defined it will be used to update the following services:</p> <ul style="list-style-type: none"> - Web Reputation Engine and Rules - DVS™ Engine - Webroot - SenderBase Network Participation sharing - L4 Traffic Monitor - IronPort URL Filters - IronPort AsyncOS upgrades <p>Proxy Server: <input type="text"/> Port: <input type="text" value="80"/></p> <p>Username: <input type="text"/></p> <p>Password: <input type="text"/></p> <p>Retype Password: <input type="text"/></p>

2. Configure the settings in Table 23-4.

Table 23-4 Update and Upgrade Settings

Setting	Description
Update Servers (images)	<p>Choose whether to download upgrade and update images from the IronPort update servers or a local web server.</p> <p>The default is the IronPort update servers. You might want to choose a local web server under either of the following circumstances:</p> <ul style="list-style-type: none"> • You want to download the upgrade and update images from IronPort, but you need to enter a static address provided by IronPort Customer Support. • You want to temporarily download an upgrade image stored on a local web server. After you download the image, IronPort recommends changing this setting back to the IronPort update servers (or the static address if you used that) so that security components continue to update automatically. <p>When you choose a local update server, enter the base URL and port number for the server. If you leave the port field blank, AsyncOS uses port 80. If the server requires authentication, you can also enter a valid user name and password.</p> <p>For more information, see “Updating and Upgrading from the IronPort Update Servers” on page 540 and “Upgrading from a Local Server” on page 540.</p>
Update Servers (list)	<p>Choose whether to download the list of available upgrades and updates (the manifest XML file) from the IronPort update servers or a local web server.</p> <p>The default is the IronPort update servers. You might want to choose a local web server when you want to temporarily download an upgrade image stored on a local web server. After you download the image, IronPort recommends changing this setting back to the IronPort update servers so that security components continue to update automatically.</p> <p>When you choose a local update server, enter the full path to the manifest XML file for the list including the file name and port number for the server. If you leave the port field blank, AsyncOS uses port 80. If the server requires authentication, you can also enter a valid user name and password.</p> <p>For more information, see “Upgrading from a Local Server” on page 540.</p>

Table 23-4 Update and Upgrade Settings (Continued)

Setting	Description
Automatic Updates	Choose whether or not to enable automatic updates of the security components. If you choose automatic updates, enter the time interval. The default is enabled and the update interval is 5 minutes.
Routing Table	Choose which network interface's routing table to use when contacting the update servers. The available proxy data interfaces are shown. Default is Management.
Proxy Server (optional)	If an upstream proxy server exists and requires authentication, enter the server information and user name and password here.

3. Submit and commit your changes.

Configuring the Update and Upgrade Settings from the CLI

The `updateconfig` command is used to configure update and upgrade settings, such as where the appliance looks for service updates and AsyncOS upgrades. The settings you configure using the `updateconfig` command are the same as you can define in the web interface. For more information on these settings, see Table 23-4 on page 544.

Note — You can use the `ping` command to ensure that the appliance can contact the local server. You can also use the `telnet` command to telnet to port 80 of the local server to ensure the local server is listening on that port.

Manually Updating Security Service Components

By default, each security service component periodically receives updates to its database tables from the IronPort update servers. However, you can manually update the database tables.

Typically, you do not need to manually update to the database tables. In the event a manual update is required, you can modify default settings and configure an update using the options on the System Administration > Upgrade and Update Settings page.

To configure a manual update:

1. Navigate to the System Administration > Upgrade and Update Settings page.
2. Click **Edit Update Settings**.
The Edit Update Settings page appears.
3. Receive the update files from IronPort and install them on a local server.
4. Specify the location of the update files.

5. Initiate the update using the Update Now function key on the component page located on the Security Services tab. For example, Security Services > Web Reputation Filters page.
6. View a record of update activity in the updater log file. Subscribe to the updater log file on the System Administration > Log Subscriptions page.

Note — Updates that are in-progress cannot be interrupted. All in-progress updates must complete before new changes can be applied.

Command Line Interface

This chapter contains the following information:

- “The Command Line Interface Overview” on page 548
- “Using the Command Line Interface” on page 549
- “General Purpose CLI Commands” on page 552
- “Web Security Appliance CLI Commands” on page 554

THE COMMAND LINE INTERFACE OVERVIEW

The IronPort AsyncOS Command Line Interface (CLI) is an interactive interface designed to allow you to configure and monitor the Web Security appliance. The commands are invoked by entering the command name with or without any arguments. If you enter a command without arguments, the command prompts you for the required information.

The Command Line Interface is accessible using SSH or Telnet on IP interfaces that have been configured with these services enabled, or using terminal emulation software on the serial port. By default, SSH and Telnet are configured on the Management port.

USING THE COMMAND LINE INTERFACE

This section describes the rules and conventions of the AsyncOS Command Line Interface.

Accessing the Command Line Interface

Access to the CLI varies depending on the management connection method chosen while setting up the appliance. The factory default username and password are listed next. Initially, only the admin user account has access to the CLI. You can add other users with differing levels of permission after you have accessed the CLI for the first time using the admin account. The System Setup Wizard prompts you to change the password for the admin account.

You can also reset the admin account password at any time using the `passwd` command.

You can connect using one of the following methods:

- **Ethernet.** Start an SSH or Telnet session with the IP address of the Web Security appliance. The factory default IP address is 192.168.42.42. SSH is configured to use port 22. Telnet is configured to use port 23.
- **Serial connection.** Start a terminal session with the communication port on your personal computer that the serial cable is connected to.

Log in to the appliance by entering the username and password below.

- Username: `admin`
- Password: `ironport`

For example:

```
login: admin
password: ironport
```

Working with the Command Prompt

The top-level command prompt consists of the fully qualified hostname, followed by the greater than (>) symbol, followed by a space. For example:

```
example.com>
```

When running commands, the CLI requires input from you. When the CLI is expecting input, the prompt displays the default values enclosed in square brackets ([]) followed by the greater than (>) symbol. When there is no default value, the brackets are empty.

For example:

```
example.com> routeconfig

Choose a routing table:
- MANAGEMENT - Routes for Management Traffic
- DATA - Routes for Data Traffic
[]>
```

When there is a default setting, the setting is displayed within the command-prompt brackets. For example:

```
example.com> setgateway

Warning: setting an incorrect default gateway may cause the current
connection
to be interrupted when the changes are committed.
Enter new default gateway:
[172.xx.xx.xx]>
```

When a default setting is shown, typing Return is equivalent to accepting the default:

Command Syntax

When operating in the interactive mode, the CLI command syntax consists of single commands with no white space and no arguments or parameters. For example:

```
example.com> logconfig
```

Select Lists

When you are presented with multiple choices for input, some commands use numbered lists. Enter the number of the selection at the prompt.

For example:

```
Log level:
1. Critical
2. Warning
3. Information
4. Debug
5. Trace
[3]> 3
```

Yes/No Queries

When given a yes or no option, the question is posed with a default in brackets. You may answer **Y**, **N**, **Yes**, or **No**. Case is not significant.

For example:

```
Do you want to enable the proxy? [Y]> Y
```

Subcommands

Some commands give you the opportunity to use subcommand directives such as **NEW**, **EDIT**, and **DELETE**. The **EDIT** and **DELETE** functions provide a list of previously configured values.

For example:

```
example.com> interfaceconfig
```



```
Currently configured interfaces:
1. Management (172.xxx.xx.xx/xx: example.com)

Choose the operation you want to perform:
- NEW - Create a new interface.
- EDIT - Modify an interface.
- DELETE - Remove an interface.
[]>
```

Within subcommands, typing Enter or Return at an empty prompt returns you to the main command.

Escaping Subcommands

You can use the Ctrl+C keyboard shortcut at any time within a subcommand to immediately exit return to the top level of the CLI.

Command History

The CLI keeps a history of all commands entered during a session. Use the Up and Down arrow keys on your keyboard, or the Ctrl+P and Ctrl+N key combinations to scroll through a running list of the recently-used commands.

Completing Commands

The IronPort AsyncOS CLI supports command completion. You can enter the first few letters of some commands followed by the Tab key and the CLI completes the string. If the letters you entered are not unique among commands, the CLI “narrows” the set. For example:

```
example.com> set (type the lab key)
setgateway, setgoodtable, sethostname, settime, settz
example.com> seth (typing the Tab again completes the entry with sethostname)
```

Configuration Changes

You can make configuration changes while web operations proceed normally.

Configuration changes do not take effect until you complete the following steps:

1. Issue the `commit` command at the command prompt.
2. Give the `commit` command the input required.
3. Receive confirmation of the `commit` procedure at the CLI.

Changes to configuration that have not been committed are recorded, but do not go into effect until you run the `commit` command. However, not all commands require the `commit` command to be run.

Exiting the CLI session, system shutdown, reboot, failure, or issuing the `clear` command clears changes that have not yet been committed.

GENERAL PURPOSE CLI COMMANDS

This section describes the some basic commands you might use in a typical CLI session, such as committing and clearing changes. For a full list of commands, see “Web Security Appliance CLI Commands” on page 554.

Committing Configuration Changes

The `commit` command allows you to change configuration settings while other operations proceed normally. Changes are not actually committed until you receive confirmation and a timestamp. Exiting the CLI session, system shutdown, reboot, failure, or issuing the `clear` command clears changes that have not yet been committed.

Entering comments after the `commit` command is optional.

```
example.com> commit

Please enter some comments describing your changes:

[ ]> Changed "psinet" IP Interface to a different IP address
Changes committed: Wed Jan 01 12:00:01 2007
```

Note — To successfully commit changes, you must be at the top-level command prompt. Type Return at an empty prompt to move up one level in the command line hierarchy.

Clearing Configuration Changes

The `clear` command clears any changes made to the appliance configuration since the last `commit` or `clear` command was issued.

```
example.com> clear

Are you sure you want to clear all changes since the last commit?
[Y]> y

Changes cleared: Wed Jan 01 12:00:01 2007
example.com>
```

Exiting the Command Line Interface Session

The `exit` command logs you out of the CLI application. Configuration changes that have not been committed are cleared.

```
example.com> exit

Configuration changes entered but not committed. Exiting will lose
changes.
Type 'commit' at the command prompt to commit changes.
```

```
Are you sure you wish to exit? [N]> y
```

Seeking Help on the Command Line Interface

The `help` command lists all available CLI commands and gives a brief description of each command. The `help` command can be invoked by typing either `help` or a single question mark (?) at the command prompt.

```
example.com> help
```

WEB SECURITY APPLIANCE CLI COMMANDS

The Web Security Appliance CLI supports a set of proxy and UNIX commands to access, upgrade, and administer the system.

Table 24-1 lists the Web Security appliance Command Line Interface commands.

Table 24-1 Web Security appliance Administrative Commands

Command	Description
<code>advancedproxyconfig</code>	Configure more advanced Web Proxy configurations, such as authentication and DNS parameters. For more information about the <code>advancedproxyconfig</code> command, see “Advanced Proxy Configuration” on page 108.
<code>adminaccessconfig</code>	You can configure the Web Security appliance to have stricter access requirements for administrators logging into the appliance. For more information about the <code>adminaccessconfig</code> command, see “Configuring Administrator Settings” on page 523.
<code>alertconfig</code>	Specify alert recipients, and set parameters for sending system alerts.
<code>certconfig</code>	Configure security certificates and keys.
<code>clear</code>	Clears pending configuration changes since last commit.
<code>commit</code>	Commits pending changes to the system configuration.
<code>createcomputerobject</code>	Creates a computer object at the location you specify.
<code>datasecurityconfig</code>	Defines a minimum request body size, below which upload requests are not scanned by the IronPort Data Security Filters. For more information, see “Bypassing Upload Requests Below a Minimum Size” on page 234.
<code>dnsconfig</code>	Configure DNS server parameters.
<code>dnsflush</code>	Flush DNS entries on the appliance.
<code>etherconfig</code>	Configure Ethernet port connections.
<code>externaldplpconfig</code>	Defines a minimum request body size, below which upload requests are not scanned by the external DLP server. For more information, see “Bypassing Upload Requests Below a Minimum Size” on page 234.

Table 24-1 Web Security appliance Administrative Commands (Continued)

<code>featurekey</code>	Submits valid keys to activate licensed features. For more information, see “Feature Keys Page” on page 515.
<code>featurekeyconfig</code>	Automatically check for and update feature keys. For more information, see “Feature Key Settings Page” on page 516.
<code>grep</code>	Searches named input files for lines containing a match to the give pattern.
<code>help</code>	Returns a list of commands.
<code>ifconfig</code> or <code>interfaceconfig</code>	Configure and manage network interfaces including M1, P1, and P2. Displays currently configured interfaces, and provides an operations menu to create, edit, or delete interfaces.
<code>smtprelay</code>	Configure SMTP relay hosts for internally generated email. An SMTP relay host is required to receive system generated email and alerts. For more information about configuring SMTP relay hosts, see “Configuring SMTP Relay Hosts” on page 502.
<code>last</code>	Lists user-specific user information that includes ttys and hosts, in reverse time order or lists the users that are logged in at a specified date and time.
<code>loadconfig</code>	Load a system configuration file.
<code>logconfig</code>	Configure access to log files.
<code>mailconfig</code>	Mail the current configuration file to the address specified.
<code>nslookup</code>	Queries Internet domain name servers for information about specified hosts and domains or to print a list of hosts in a domain.
<code>ntpconfig</code>	Configure NTP servers. Displays currently configured interfaces, and provides an operations menu to add, remove, or set the interface from whose IP address NTP queries should originate.
<code>packetcapture</code>	Intercepts and displays TCP/IP and other packets being transmitted or received over the network to which the appliance is attached. For more information, see “Packet Capture” on page 511.
<code>passwd</code>	Set the password.

Table 24-1 Web Security appliance Administrative Commands (Continued)

<code>pathmtudiscovery</code>	Enables or disables Path MTU Discovery. You might want to disable Path MTU Discovery if you need to packet fragmentation.
<code>ping</code>	Sends an ICMP ECHO REQUEST to the specified host or gateway.
<code>proxyconfig</code> <enable disable>	Enables or disables the Web Proxy.
<code>proxystat</code>	Display web proxy statistics.
<code>quit, q, exit</code>	Terminates an active process or session.
<code>reboot</code>	Flushes the file system cache to disk, halts all running processes, and restarts the system.
<code>reportingconfig</code>	Configure a reporting system.
<code>resetconfig</code>	Restores the configuration to factory defaults.
<code>rollovernow</code>	Roll over a log file.
<code>routeconfig</code>	Configure destination IP addresses and gateways for traffic. Displays currently configured routes, and provides an operations menu to create, edit, or delete, or clear entries.
<code>saveconfig</code>	Saves a copy of the current configuration settings to a file. This file can be used to restore defaults, if necessary.
<code>setgateway</code>	Configure the default gateway for the machine.
<code>sethostname</code>	Set the hostname parameter.
<code>setntlmsecuritymode</code>	Changes the security setting for the NTLM authentication realm to either "ads" or "domain." When the setting is "domain," the appliance joins the Active Directory domain with a domain security trust account, and when the setting is "ads," it joins the domain as a native Active Directory member. Default is ads.
<code>settime</code>	Set system time.
<code>settz</code>	Displays the current time zone, and provides an operations menu to set a local time zone.
<code>showconfig</code>	Display all configuration values.

Table 24-1 Web Security appliance Administrative Commands (Continued)

<code>shutdown</code>	Terminates connections and shuts down the system.
<code>snmpconfig</code>	Configure the local host to listen for SNMP queries and allow SNMP requests.
<code>sshconfig</code>	Configure hostname and host key options for trusted servers.
<code>status</code>	Displays system status.
<code>supportrequest</code>	Send the support request email to IronPort customer care. This includes system information and a copy of the master configuration. The e-mail address is "support@ironport.com".
<code>tail</code>	Displays the end of a log file. Command accepts log file name or number as parameters. example.com> tail system_logs example.com> tail 9
<code>techsupport</code>	Provides a temporary connection to allow IronPort Customer Care/Applications Engineering to access the system and assist in troubleshooting.
<code>testauthconfig</code>	Tests the authentication settings for a given authentication realm against the authentication servers defined in the realm. For more information about testing authentication settings, see "Testing Authentication Settings" on page 370.
<code>telnet</code>	Communicates with another host using the TELNET protocol.
<code>traceroute</code>	Traces IP packets through gateways and along the path to a destination host.
<code>updateconfig</code>	Configure update and upgrade settings. For more information, see "Configuring Upgrade and Service Update Settings" on page 539.
<code>upgrade</code>	Install an AsyncOS software upgrade.
<code>userconfig</code>	Configure system administrators.
<code>version</code>	Displays general system information, installed versions of system software, and rule definitions.

Table 24-1 Web Security appliance Administrative Commands (Continued)

webcache	Examine or modify the contents of the proxy cache, or configure domains and URLs that the appliance never caches. Allows an administrator to remove a particular URL from the proxy cache or specify which domains or URLs to never store in the proxy cache. For more information, see “Web Proxy Cache” on page 86.
who	Displays who is logged into the system.
whoami	Displays user information.

IronPort End User License Agreement

This appendix contains the following section:

- “Cisco IronPort Systems, LLC Software License Agreement” on page 560

CISCO IRONPORT SYSTEMS, LLC SOFTWARE LICENSE AGREEMENT

NOTICE TO ALL USERS: CAREFULLY READ THE FOLLOWING LEGAL AGREEMENT (“AGREEMENT”) FOR THE LICENSE OF THE SOFTWARE (AS DEFINED BELOW). BY CLICKING THE ACCEPT BUTTON OR ENTERING “Y” WHEN PROMPTED, YOU (EITHER AN INDIVIDUAL OR A SINGLE ENTITY, COLLECTIVELY, THE “COMPANY”) CONSENT TO BE BOUND BY AND BECOME A PARTY TO THE FOLLOWING AGREEMENT BETWEEN CISCO IRONPORT SYSTEMS, LLC, A DELAWARE CORPORATION (“IRONPORT”) AND COMPANY (COLLECTIVELY, THE “PARTIES”). BY CLICKING THE ACCEPT BUTTON OR ENTERING “Y” WHEN PROMPTED, YOU REPRESENT THAT (A) YOU ARE DULY AUTHORIZED TO REPRESENT YOUR COMPANY AND (B) YOU ACCEPT THE TERMS AND CONDITIONS OF THIS AGREEMENT ON BEHALF OF YOUR COMPANY, AND AS SUCH, AN AGREEMENT IS THEN FORMED. IF YOU OR THE COMPANY YOU REPRESENT (COLLECTIVELY, “COMPANY”) DO NOT AGREE TO THE TERMS AND CONDITIONS OF THIS AGREEMENT, CLICK THE CANCEL BUTTON OR ENTER “N” WHEN PROMPTED AND PROMPTLY (BUT NO LATER THAT THIRTY (30) DAYS OF THE DELIVERY DATE, AS DEFINED BELOW) NOTIFY IRONPORT, OR THE RESELLER FROM WHOM YOU RECEIVED THE SOFTWARE, FOR A FULL REFUND OF THE PRICE PAID FOR THE SOFTWARE.

1. DEFINITIONS

1.1 “Company Service” means the Company’s email or internet services provided to End Users for the purposes of conducting Company’s internal business and which are enabled via Company’s products as described in the purchase agreement, evaluation agreement, beta or pre-release agreement, purchase order, sales quote or other similar agreement between the Company and IronPort or its reseller (“Agreement”) and the applicable user interface and IronPort’s standard system guide documentation that outlines the system architecture and its interfaces (collectively, the “License Documentation”).

1.2 “End User” means the employee, contractor or other agent authorized by Company to access to the Internet or use email services via the Company Service.

1.3 “Service(s)” means (i) the provision of the Software functionality, including Updates and Upgrades, and (ii) the provision of support by IronPort or its reseller, as the case may be.

1.4 “Software” means: (i) IronPort’s proprietary software licensed by IronPort to Company along with IronPort’s hardware products; (ii) any software provided by IronPort’s third-party licensors that is licensed to Company to be implemented for use with IronPort’s hardware products; (iii) any other IronPort software module(s) licensed by IronPort to Company along with IronPort’s hardware products; and (iv) any and all Updates and Upgrades thereto.

1.5 “Updates” means minor updates, error corrections and bug fixes that do not add significant new functions to the Software, and that are released by IronPort or its third party licensors. Updates are designated by an increase to the Software’s release number to the right of the decimal point (e.g., Software 1.0 to Software 1.1). The term Updates specifically excludes Upgrades or new software versions marketed and licensed by IronPort or its third party licensors as a separate product.

1.6 “Upgrade(s)” means revisions to the Software, which add new enhancements to existing functionality, if and when it is released by IronPort or its third party licensors, in their sole discretion. Upgrades are designated by an increase in the Software’s release number, located to the left of the decimal point (e.g., Software 1.x to Software 2.0). In no event shall Upgrades include any new versions of the Software marketed and licensed by IronPort or its third party licensors as a separate product.

2. LICENSE GRANTS AND CONSENT TO TERMS OF DATA COLLECTION

2.1 License of Software. By using the Software and the License Documentation, Company agrees to be bound by the terms of this Agreement, and so long as Company is in compliance with this Agreement, IronPort hereby grants to Company a non-exclusive, non-sublicensable, non-transferable, worldwide license during the Term to use the Software only on IronPort’s hardware products, solely in connection with the provision of the Company Service to End Users. The duration and scope of this license(s) is further defined in the License Documentation. Except as expressly provided herein, no right, title or interest in any Software is granted to the Company by IronPort, IronPort’s resellers or their respective licensors. This license and any Services are co-terminus.

2.2 Consent and License to Use Data. Subject to Section 8 hereof, and subject to the IronPort Privacy Statement at <http://www.IronPort.com/privacy.html>, as the same may be amended from time to time by IronPort with notice to Company, Company hereby consents and grants to IronPort a license to collect and use the data from the Company as described in the License Documentation, as the same may be updated from time to time by IronPort (“Data”). To the extent that reports or statistics are generated using the Data, they shall be disclosed only in the aggregate and no End User identifying information may be surmised from the Data, including without limitation, user names, phone numbers, unobfuscated file names, email addresses, physical addresses and file content. Notwithstanding the foregoing, Company may terminate IronPort’s right to collect and use Data at any time upon prior written or electronic notification, provided that the Software or components of the Software may not be available to Company if such right is terminated.

3. CONFIDENTIALITY. Each Party agrees to hold in confidence all Confidential Information of the other Party to the same extent that it protects its own similar Confidential Information (and in no event using less than a reasonable degree of care) and to use such Confidential Information only as permitted under this Agreement. For purposes of this Agreement “Confidential Information” means information of a party marked “Confidential” or information reasonably considered by the disclosing Party to be of a proprietary or confidential nature; provided that the Data, the Software, information disclosed in design reviews and any pre-production releases of the Software provided by IronPort is expressly designated Confidential Information whether or not marked as such.

4. PROPRIETARY RIGHTS; OWNERSHIP. Title to and ownership of the Software and other materials and all associated Intellectual Property Rights (as defined below) related to the foregoing provided by IronPort or its reseller to Company will remain the exclusive property of IronPort and/or its superior licensors. Company and its employees and agents will not remove or alter any trademarks, or other proprietary notices, legends, symbols, or labels

appearing on or in copies of the Software or other materials delivered to Company by IronPort or its reseller. Company will not modify, transfer, resell for profit, distribute, copy, enhance, adapt, translate, decompile, reverse engineer, disassemble, or otherwise determine, or attempt to derive source code for any Software or any internal data files generated by the Software or to create any derivative works based on the Software or the License Documentation, and agrees not to permit or authorize anyone else to do so. Unless otherwise agreed in writing, any programs, inventions, concepts, documentation, specifications or other written or graphical materials and media created or developed by IronPort or its superior licensors during the course of its performance of this Agreement, or any related consulting or professional service agreements, including all copyrights, database rights, patents, trade secrets, trademark, moral rights, or other intellectual property rights (“Intellectual Property Right(s)”) associated with the performance of such work shall belong exclusively to IronPort or its superior licensors and shall, in no way be considered a work made for hire for Company within the meaning of Title 17 of the United States Code (Copyright Act of 1976).

5. LIMITED WARRANTY AND WARRANTY DISCLAIMERS

5.1 Limited Warranty. IronPort warrants to Company that the Software, when properly installed and properly used, will substantially conform to the specifications in the License Documentation for a period of ninety (90) days from the delivery date or the period set forth in the License Documentation, whichever is longer (“Warranty Period”). FOR ANY BREACH OF THE WARRANTY CONTAINED IN THIS SECTION, COMPANY’S EXCLUSIVE REMEDY AND IRONPORT’S ENTIRE LIABILITY, WILL BE PROMPT CORRECTION OF ANY ERROR OR NONCONFORMITY, PROVIDED THAT THE NONCONFORMITY HAS BEEN REPORTED TO IRONPORT AND/OR ITS RESELLER BY COMPANY WITHIN THE WARRANTY PERIOD. THIS WARRANTY IS MADE SOLELY TO COMPANY AND IS NOT TRANSFERABLE TO ANY END USER OR OTHER THIRD PARTY. IronPort shall have no liability for breach of warranty under this Section or otherwise for breach of this Agreement if such breach arises directly or indirectly out of or in connection with the following: (i) any unauthorized, improper, incomplete or inadequate maintenance or calibration of the Software by Company or any third party; (ii) any third party hardware software, services or system(s); (iii) any unauthorized modification or alteration of the Software or Services; (iv) any unauthorized or improper use or operation of the Software or Company’s failure to comply with any applicable environmental specification; or (v) a failure to install and/or use Updates, Upgrades, fixes or revisions provided by IronPort or its resellers from time to time.

5.2 WARRANTY DISCLAIMER. THE EXPRESS WARRANTIES SET FORTH IN SECTION 5.1 OF THIS AGREEMENT CONSTITUTE THE ONLY PERFORMANCE WARRANTIES WITH RESPECT TO THE SOFTWARE OR SERVICES. TO THE MAXIMUM EXTENT PERMITTED BY APPLICABLE LAW, IRONPORT LICENSES THE SOFTWARE AND SERVICES HEREUNDER ON AN “AS IS” BASIS. EXCEPT AS SPECIFICALLY SET FORTH HEREIN, IRONPORT AND ITS SUPERIOR LICENSORS MAKE NO REPRESENTATIONS OR WARRANTIES OF ANY KIND, WHETHER EXPRESS, IMPLIED, OR STATUTORY (EITHER IN FACT OR BY OPERATION OF LAW), AND EXPRESSLY DISCLAIM ALL OTHER WARRANTIES, INCLUDING WITHOUT LIMITATION, THE IMPLIED WARRANTIES OF MERCHANTABILITY OR FITNESS FOR A PARTICULAR PURPOSE. NEITHER IRONPORT NOR ITS THIRD PARTY LICENSORS

WARRANT THAT THE SOFTWARE OR SERVICES (1) IS FREE FROM DEFECTS, ERRORS OR BUGS, (2) THAT OPERATION OF THE SOFTWARE WILL BE UNINTERRUPTED, OR (3) THAT ANY RESULTS OR INFORMATION THAT IS OR MAY BE DERIVED FROM THE USE OF THE SOFTWARE WILL BE ACCURATE, COMPLETE, RELIABLE AND/OR SECURE.

6. LIMITATION OF LIABILITY. TO THE MAXIMUM EXTENT PERMITTED BY APPLICABLE LAW, IN NO EVENT WILL EITHER PARTY BE LIABLE TO THE OTHER FOR ANY LOSS OF PROFITS, COSTS OF PROCUREMENT OF SUBSTITUTE GOODS OR SERVICES, LOSS OF BUSINESS, LOSS OF USE OR DATA, INTERRUPTION OF BUSINESS, OR FOR INDIRECT, SPECIAL, INCIDENTAL OR CONSEQUENTIAL DAMAGES OF ANY KIND, EVEN IF SUCH PARTY RECEIVED ADVANCE NOTICE OF THE POSSIBILITY OF SUCH DAMAGES. IN NO EVENT SHALL THE LIABILITY OF EITHER PARTY ARISING UNDER ANY PROVISION OF THIS AGREEMENT, REGARDLESS OF WHETHER THE CLAIM FOR SUCH DAMAGES IS BASED IN CONTRACT, TORT, OR OTHER LEGAL THEORY, EXCEED THE TOTAL AMOUNT PAID FOR THE SOFTWARE OR SERVICES DURING THE TWELVE (12) MONTHS PRIOR TO THE EVENT GIVING RISE TO SUCH LIABILITY.

7. TERM AND TERMINATION. The term of this Agreement shall be as set forth in the License Documentation (the "Term"). If IronPort defaults in the performance of any material provision of this Agreement or the License Documentation, then Company may terminate this Agreement upon thirty (30) days written notice if the default is not cured during such thirty (30) day period. If Company defaults in the performance of any material provision of this Agreement or the License Documentation, IronPort may terminate this Agreement upon thirty (30) days written notice if the default is not cured during such thirty (30) day notice and without a refund. This Agreement may be terminated by one Party immediately at any time, without notice, upon (i) the institution by or against the other Party of insolvency, receivership or bankruptcy proceedings or any other proceedings for the settlement of such Party's debts, (ii) such other Party making a general assignment for the benefit of creditors, or (iii) such other Party's dissolution. The license granted in Section 2 will immediately terminate upon this Agreement's termination or expiration. Within thirty (30) calendar days after termination or expiration of this Agreement, Company will deliver to IronPort or its reseller or destroy all copies of the Software and any other materials or documentation provided to Company by IronPort or its reseller under this Agreement.

8. U.S. GOVERNMENT RESTRICTED RIGHTS; EXPORT CONTROL. The Software and accompanying License Documentation are deemed to be "commercial computer software" and "commercial computer software documentation," respectively, pursuant to DFAR Section 227.7202 and FAR Section 12.212, as applicable. Any use, modification, reproduction, release, performance, display or disclosure of the Software and accompanying License Documentation by the United States Government shall be governed solely by the terms of this Agreement and shall be prohibited except to the extent expressly permitted by the terms of this Agreement. Company acknowledges that the Software and License Documentation must be exported in accordance with U.S. Export Administration Regulations and diversion contrary to U.S. laws is prohibited. Company represents that neither the United States Bureau of Export Administration nor any other federal agency has suspended, revoked or denied Company export privileges. Company represents that Company will not use or transfer the

Software for end use relating to any nuclear, chemical or biological weapons, or missile technology unless authorized by the U.S. Government by regulation or specific license. Company acknowledges it is Company's ultimate responsibility to comply with any and all import and export restrictions, and other applicable laws, in the U.S. or elsewhere, and that IronPort or its reseller has no further responsibility after the initial sale to Company within the original country of sale.

9. MISCELLANEOUS. This Agreement is governed by the laws of the United States and the State of California, without reference to conflict of laws principles. The application of the United Nations Convention of Contracts for the International Sale of Goods is expressly excluded. Nothing contained herein shall be construed as creating any agency, partnership, or other form of joint enterprise between the parties. Neither party shall be liable hereunder by reason of any failure or delay in the performance of its obligations hereunder (except for the payment of money) on account of (i) any provision of any present or future law or regulation of the United States or any applicable law that applies to the subject hereof, and (ii) interruptions in the electrical supply, failure of the Internet, strikes, shortages, riots, insurrection, fires, flood, storm, explosions, acts of God, war, terrorism, governmental action, labor conditions, earthquakes, or any other cause which is beyond the reasonable control of such party. This Agreement and the License Documentation set forth all rights for the user of the Software and is the entire agreement between the parties and supersedes any other communications with respect to the Software and License Documentation. The terms and conditions of this Agreement will prevail, notwithstanding any variance with the License Documentation or any purchase order or other written instrument submitted by a party, whether formally rejected by the other party or not. This Agreement may not be modified except by a written addendum issued by a duly authorized representative of IronPort, except that IronPort may modify the IronPort Privacy Statement at any time, in its discretion, via notification to Company of such modification that will be posted at <http://www.IronPort.com/privacy.html>. No provision hereof shall be deemed waived unless such waiver shall be in writing and signed by IronPort or a duly authorized representative of IronPort. If any provision of this Agreement is held invalid, the remainder of this Agreement shall continue in full force and effect. The parties confirm that it is their wish that this Agreement has been written in the English language only.

10. IRONPORT CONTACT INFORMATION. If Company wants to contact IronPort for any reason, please write to IronPort Systems, Inc., 950 Elm Avenue, San Bruno, California 94066, or call or fax us at tel: 650.989.6500 and fax: 650.989.6543.

Index

A

access log file

- see also *W3C access logs*
- ACL decision tags 459
- anti-malware information 462
- anti-malware request example entry 465
- anti-malware response example entry 466
- custom formatting 470
- no category (nc) 465
- no score (ns) 465
- overview 456
- result codes 458
- URL category abbreviations 313
- Web Reputation Filters example entry 465
- web reputation information 462

access logs

- custom fields 479

Access Policies

- anti-malware 181
- applications 179
- configuring Web Reputation 335
- creating 174
- flow diagram 178
- guest users 155
- membership 172
- Monitor action 171
- objects 180
- overview 170
- protocol of request 175
- proxy port of request 175
- redirecting traffic 304
- subnet of request 175
- time of request 176
- URL category of request 176
- URL filters 179
- user agent of request 176
- Web Reputation 181

Access Policy groups

- see also *policy groups*

ACL decision tags

- access log file 459

Active Directory

- changing passwords 390
- joining the domain 398

- multiple domains 396

active mode

- enabling for FTP 120

adding

- log subscriptions 451
- WCCP service 498

addresses

- ambiguous address 407
- known allowed address 407
- known malware address 407
- unlisted address 407

adminaccessconfig command

- overview 523

administering the appliance

- connecting to the management interface 17
- System Setup Wizard 17

administrator access

- configuring for IP addresses 523
- configuring SSL ciphers 523

advancedproxyconfig command

- overview 108

- web proxy usage agreement 100

alert recipient 525

alert settings 525

alerts

- alert classifications 525
- recipients 525
- settings 525
- severities 526

All Identities

- overview 134

allowing traffic

- L4 Traffic Monitor 407

ambiguous address

- defined 407

anti-malware

- access log file 352
- access log information 462
- configuring 348
- databases 342
- overview 340
- parameter settings 348
- report 423
- rules for L4 Traffic Monitor 409
- scanning verdicts 480
- viewing activity 352

anti-malware rules

- L4 Traffic Monitor 409

- anti-malware scanning
 - bypassing 98
 - appliance host name
 - DNS support 50
 - application filtering
 - Access Policies 179
 - archiving reports 438
 - assignment method
 - WCCP service 496
 - AsyncOS upgrades
 - overview 537
 - authentication
 - behavior with multiple realms 369
 - compared to authorization 133
 - configuring global settings 373
 - configuring LDAP 390
 - configuring NTLM 396
 - defined 133
 - entering the domain 355
 - exempting user agents 140
 - failure 356
 - global Identity policy 149
 - guest access 155
 - HTTPS requests 149
 - Identity groups 148
 - LDAP 390
 - native FTP 93
 - NTLM 396
 - overview 354
 - realms 364
 - re-authenticating users 386
 - secure LDAP 390
 - sending credentials securely 383
 - sequences 366
 - special characters 401
 - supported characters for Basic 396
 - surrogates 386
 - surrogates supported 389
 - testing settings 370
 - upstream proxies 355
 - authentication credentials
 - defined 357
 - invalid 356
 - sending securely 383
 - authentication realms
 - behavior with multiple realms 369
 - creating 364
 - deleting 365
 - editing 365
 - overview 364
 - testing settings 370
 - authentication scheme
 - Identity group 151
 - authentication sequences
 - behavior with multiple realms 369
 - creating 367
 - deleting 368
 - editing 367
 - overview 366
 - authentication server
 - unavailable 356
 - authentication surrogates
 - supported 389
 - authorization
 - defined 133
 - failing 386
 - AutoSupport feature 527
 - available upgrades 537
- B**
- backing up
 - keys for FIPS management 79
 - Basic authentication
 - securely sending credentials 383
 - blacklist address
 - see *known malware address*
 - blocking
 - applications 182
 - file types 184
 - HTTPS traffic 210
 - instant messenger 182
 - objects 180, 184, 247
 - peer-to-peer 184
 - ports 179
 - protocols 179
 - traffic 410
 - upload requests 235, 307
 - URL categories 179, 246
 - user agents 179
 - user experience 235, 307
 - blocking traffic
 - L4 Traffic Monitor 407
 - browsers
 - see *web browsers*
 - bypassing
 - scanning and filtering 98
 - upload requests from scanning 234

C

CA

see *certificate authorities*

capturing network packets

overview 511

case-sensitivity

in CLI 550

category filtering

database 290

certificate authorities

validating 208

certificate authority

defined 204

certificate files

see also *root certificates*

converting formats 215

supported formats 213

uploading 77, 219

certificates

backing up for FIPS management 79

FIPS management 69, 74

generating and signing your own 535

installing for credential encryption 384

installing on appliance 535

invalid 220

overview 208

root 213

types supported for FIPS 73

validating 210

validating certificate authorities 208

Change Password link 519

changing passwords 519

cipher

defined 204

ciphertext

defined 204

Cisco IronPort Web Usage Controls

overview 288

cleartext

defined 204

CLI

case-sensitivity in 550

clearing changes 26

`clonesource` 83

`clonetarget` 83

committing changes 26

configuring host keys 450

`fipsconfig` 81

initializing the HSM card 70

overview 18, 548

rolling over log files 449

SSH 549

telnet 549

viewing most recent log files 450

Client Malware Risk report 421

Client Web Activity report 421

`clonesource` command 83

`clonetarget` command 83

command line interface

see *CLI*

Commit Changes button

overview 25

`commit` command 26, 552

committing changes

`commit` command 26

overview 25

community string

SNMP 427

compressing

log files 450

computer account

joining an Active Directory domain 398

configuration file 508

configuring 489

administrator settings 523

custom text at login 523

data interfaces 485

FTP proxy, advanced options 108

host keys 450

Identities 162

proxy cache options 108

return addresses 524

URL filters 292

WCCP router 35

web proxy, advanced options 108

Web Reputation Filters 335

configuring the appliance

anti-malware 348

browser requirements 21

clearing changes 25

committing changes 25, 508

enabling features 515

L4 Traffic Monitor 409

log files 448

network interfaces 485

P2 port 485

reporting 434

scheduling reports 435

- submitting changes 508
- upstream proxies 40
- Web Proxy settings 88
- connecting
 - L4 Traffic Monitor 41
 - web proxy in explicit forward mode 33
 - web proxy in transparent mode 34
- connecting the appliance
 - L4 switch 31, 46
 - P1 and P2 ports 31, 46
 - WCCP router 31, 46
- content filtering
 - IronPort Data Security Policies 247
- control settings
 - Decryption Policies 227
- creating
 - Access Policies 174
 - authentication realms 364
 - authentication sequences 367
 - Decryption Policies 223
 - External DLP Policies 241
 - Identities 158
 - IronPort Data Security Policies 241
 - log subscriptions 451
 - Routing Policies 195
 - time ranges 136
 - user agent based policies 138
- credential encryption
 - certificate and key 384
 - FIPS management 69
 - HTTPS requests 384
 - overview 383
- cryptography
 - certificate authority 204
 - cipher 204
 - ciphertext 204
 - cleartext 204
 - digital certificate 204
 - digital signature 204
 - key 204
 - overview 204
 - plaintext 204
 - private key 205
 - public key 204
 - public key infrastructure 205
 - root certificate 205
 - self-signed certificate 205
 - symmetric key 205
- CSS
 - in end-user notification pages 278
- custom certificate authority
 - importing 231
- custom fields
 - access and W3C logs 479
- custom text 523
 - at login 523
- custom URL categories
 - overview 301
 - redirecting traffic 304
- customizing
 - log files 470
- D**
- data interfaces
 - configuring 485
 - overview 30
- data loss prevention
 - see *Data Security Policies*
 - see *External DLP Policies*
- Data Security logs
 - overview 254
- Data Security Policies
 - configuring 245
 - content 247
 - creating 241
 - flow diagram 246
 - logging 254
 - membership 239
 - minimum request size 234
 - Monitor action 237
 - overview 234
 - protocol of request 242
 - proxy port of request 243
 - subnet of request 243
 - upload request definition 236
 - URL category of request 243
 - URL filters 246
 - user agent of request 244
 - Web Reputation 247
- Data Security Policy groups
 - see also *policy groups*
- datasecurityconfig
 - CLI command 234
- debugging
 - policy groups 141
- decrypting
 - HTTPS traffic 200

-
- overview 211
 - decrypting HTTPS traffic
 - configuring Decryption Policies 201
 - overview 211
 - Decryption Policies
 - blocking 210
 - control settings 227
 - controlling traffic 227
 - creating 223
 - cryptography 204
 - decrypting traffic 201, 211
 - dropping traffic 201
 - enabling 217
 - flow diagram 221, 229
 - guest users 155
 - membership 221
 - Monitor action 202
 - overview 200
 - passing through traffic 201
 - proxy port of request 224
 - root certificates 213
 - subnet of request 225
 - time of request 225
 - URL category of request 225
 - user agent of request 225
 - Decryption Policy groups
 - see also *policy groups*
 - default gateway 489
 - default route
 - configuring 489
 - deleting
 - a URL from the web proxy cache 86
 - authentication realms 365
 - authentication sequences 368
 - log subscriptions 455
 - WCCP service 501
 - DEM format
 - converting 215
 - deploying the appliance
 - L4 Traffic Monitor 29, 41
 - multiple appliances and WCCP routers 39
 - overview 28
 - see also *deployment*
 - web proxy 28
 - deployment
 - connecting to a WCCP router 35
 - example scenario 31
 - existing proxies 40
 - L4 Traffic Monitor 41
 - overview 28
 - PAC files 33
 - preparing for 28
 - web proxy in explicit forward mode 33
 - web proxy in transparent mode 34
 - depth of appliance 43
 - DHCP
 - WPAD 104
 - digital certificate
 - defined 204
 - see also *certificates*
 - digital cryptography
 - see *cryptography*
 - digital signature
 - defined 204
 - dimensions of appliance 43
 - DLP servers
 - defining 249
 - failover 250
 - DNS
 - configuring 504
 - installing the appliance 50
 - split 504
 - WPAD 104
 - DNS cache
 - flushing 505
 - domain
 - entering for authentication 355
 - dropping traffic
 - Decryption Policies 201
 - duplex
 - deploying the L4 Traffic Monitor 41
 - network tap 47
 - DVS engine
 - how it works 342
 - overview 342
 - working with multiple malware verdicts 343
 - Dynamic Content Analysis engine
 - enabling 291
 - overview 288
 - dynamic service
 - WCCP services 495
 - Dynamic Vectoring and Streaming engine
 - see *DVS engine*
- ## E
- editing
 - authentication realms 365
 - authentication sequences 367
-

- WCCP service 498
- editing the appliance
 - concurrent editing 21
- enabling
 - active mode for FTP 120
 - HTTPS Proxy 217
 - P2 port 485
- end-user acknowledgement page
 - configuring 273
 - overview 272
- end-user notification pages
 - formatting text 278
 - HTML tags 278
 - IronPort notification pages 262
 - native FTP 277
 - overview 258
 - user defined notification pages 269
- end-user URL category page
 - configuring 276
 - warning users 306
- `etherconfig` command
 - VLAN 492
- evaluating Access Policy membership
 - matching client requests 172
- evaluating Data Security Policy membership
 - matching client requests 239
- evaluating Decryption Policy membership
 - matching client requests 221
- evaluating External DLP Policy membership
 - matching client requests 239
- evaluating Identity group membership
 - authentication 148
 - authentication scheme 151
 - examples 165
 - matching client requests 152
 - overview 147
- evaluating policy group membership
 - overview 133
- evaluating Routing Policy membership
 - matching client requests 193
- exempting
 - user agents from authentication 140
- expired keys
 - overview 516
- exporting
 - reports 439
- External DLP Policies
 - configuring 252
 - creating 241

- defining external DLP servers 249
- load balancing 250
- logging 254
- membership 239
- minimum request size 234
- overview 234
- protocol of request 242
- proxy port of request 243
- subnet of request 243
- URL category of request 243
- user agent of request 244
- External DLP Policy groups
 - see also *policy groups*
- external DLP servers
 - see *DLP servers*
- `externaldlpconfig`
 - CLI command 234

F

- failed authentication
 - allowing guest access 155
 - overview 356
- failing authorization 386
- failover
 - DLP servers 250
 - Routing Policies 189
- feature keys
 - adding manually 516
 - expired keys 516
 - overview 515
 - settings 516
- Federal Information Processing Standard
 - see *FIPS management*
- filtering
 - anti-malware 181
 - applications 179
 - category 179, 246
 - data in IronPort Data Security Policies 247
 - objects in Access Policies 180
 - Web Reputation 181, 247
- FIPS management
 - backing up certificates and keys 79
 - cloning HSM cards 83
 - credential encryption 75
 - default password 71
 - explained 69
 - FIPS Officer 72
 - HSM card 70
 - HTTPS Proxy 76

- logging 73
- logging into 71
- managing certificates and keys 74
- multiple HSM cards 83
- overview 68
- secure authentication 75
- supported certificate types 73
- FIPS management console
 - logging into 71
- FIPS Officer
 - default password 71
 - overview 72
- `fipsconfig` command 81
- Firefox
 - PAC files 107
- formatting
 - access log 470
 - end-user acknowledge pages 278
 - end-user notification pages 278
- forwarding method
 - GRE 497
 - L2 497
 - WCCP service 497
- FTP
 - see also *native FTP*
 - active mode 92, 108
 - configuring notification messages 277
 - enabling active mode 120
 - FTP over HTTP 92
 - passive mode 92
- FTP Poll 453
- FTP Proxy
 - overview 92
- FTP proxy
 - advanced configuration 108
- FTP Push 454

G

- generating
 - root certificates 76, 218
 - root certificates for HTTPS 213
- global Identity policy
 - authentication 149
- global policy group
 - overview 130
- GRE
 - forwarding method 497
- greylist address
 - see *ambiguous address*

- guest access
 - overview 155

H

- hash assignment
 - WCCP assignment method 496
- height of appliance 43
- heuristic analysis
 - McAfee scanning engine 346
- host keys
 - configuring 450
- host name
 - appliance 50
 - changing 484
- `hostkeyconfig` command 450
- HSM card
 - cloning 83
 - initializing 70
 - working with multiple 83
- HTTP/HTTPS headers
 - logging 479
- HTTPS
 - authentication 149
 - certificate authority definition 204
 - cipher definition 204
 - ciphertext definition 204
 - cleartext definition 204
 - credential encryption 384
 - digital certificate definition 204
 - digital signature definition 204
 - key definition 204
 - overview 206
 - plaintext definition 204
 - private key cryptography definition 205
 - public key cryptography definition 204
 - public key infrastructure definition 205
 - root certificate definition 205
 - self-signed certificate definition 205
 - symmetric key cryptography definition 205
- HTTPS Proxy
 - FIPS management 69
- HTTPS requests
 - authentication 149

I

- Identities
 - about 146
 - authentication 148
 - configuring in policy groups 162

- creating 158
- evaluating membership 147
- guest privileges 155
- multiple 162

Identity groups

- proxy port of request 147
- see also *policy groups*
- URL category of request 147
- user agent of request 147

importing

- trusted root certificates 231

init command 70

installing the appliance

- prerequisites 46
- setup worksheet 47

interfaceconfig command

- VLAN 493

interfaces

- see *network interfaces* 485

Internet Explorer

- re-authentication 387
- WPAD 104

invalid certificates

- handling 220

IP based access

- about 523

IP spoofing

- WCCP service 497

IPMI

- SNMP 428

IronPort Data Security Filters

- overview 234

IronPort Data Security Policies

- see *Data Security Policies*

IronPort notification pages

- formatting text 278
- HTML tags 278
- overview 262

IronPort URL Filters

- overview 288
- see *URL filters*

J

joining

- Active Directory domain 398

K

key

- defined 204

key files

- see also *root certificates*
- converting formats 215
- supported formats 213

keys

- backing up for FIPS management 79
- FIPS management 69, 74
- overview 515

known allowed address

- defined 407

known malware address

- defined 407

L

L2

- forwarding method 497

L4 Traffic Monitor

- allow list 411

- allowing traffic 407

- ambiguous addresses 407

- anti-malware rules 409

- blocking 410

- blocking traffic 407

- configuring 409

- database 408

- deploying 29, 41

- how it works 407

- interfaces 31

- known allowed addresses 407

- known malware addresses 407

- L2 switch 41

- log files 482

- monitoring 410

- monitoring traffic 407

- overview 406

- report 420

- span/mirror port 41

- unlisted addresses 407

- viewing activity 413

L4 Traffic Monitor interfaces

- overview 31

last command 520

Layer 4 switch

- connecting to the appliance 46

LDAP

- overview 390

- testing settings 370

load balancing

- traffic to external DLP servers 250

-
- traffic to upstream proxies 189
 - load-balancing method
 - see *assignment method*
 - log fields
 - W3C access logs 468
 - log files
 - see also *log subscriptions*
 - compressed 450
 - configuring host keys for SSH 450
 - configuring the level of information recorded 452
 - custom 470
 - extensions in filenames 449
 - formatting access and W3C logs 470
 - HTTP/HTTPS headers 479
 - L4 Traffic Monitor 482
 - naming convention 449
 - overview 442
 - types 442
 - viewing most recent version 450
 - log subscriptions
 - adding 451
 - compressing 450
 - deleting 455
 - editing 451
 - overview 448
 - rolling over 449
 - logging
 - HTTP/HTTPS headers 479
 - logging in
 - FIPS management console 71
 - web interface 21
 - login 523
 - logs
 - see also *log files*
 - FTP Poll 453
 - FTP Push 454
 - overview 442
 - rolling over 449
 - SCP Push 454
 - Syslog Push 454
 - M**
 - M1 interface
 - overview 30
 - M1 port
 - connecting to a laptop 46
 - MAIL FROM
 - configuring for notifications 524
 - malware
 - configuring scanning 348
 - see also *anti-malware*
 - malware verdicts
 - multiple 343
 - management interface
 - overview 30
 - managing the appliance
 - connecting to a laptop 46
 - connecting to the management interface 17
 - System Setup Wizard 17
 - mask assignment
 - WCCP assignment method 496
 - matching client requests
 - Access Policies 172
 - Decryption Policies 221
 - External DLP Policies 239
 - Identities 152
 - IronPort Data Security Policies 239
 - Routing Policies 193
 - McAfee scanning engine
 - categories 347
 - database 342
 - heuristic analysis 346
 - overview 346
 - membership diagram
 - Access Policies 172
 - Decryption Policies 221
 - External DLP Policies 239
 - Identities 152
 - IronPort Data Security Policies 239
 - Routing Policies 193
 - MIB file
 - SNMP 427
 - mirror port
 - deploying the L4 Traffic Monitor 41
 - misclassified URLs
 - reporting 263
 - Monitor
 - Access Policies 171
 - Decryption Policies 202
 - IronPort Data Security Policies 237
 - monitoring
 - L4 Traffic Monitor 410
 - overview 416
 - ports 410
 - scheduling reports 435
 - summary data 434
 - system activity 419
-

- traffic 407
- users from the CLI 519
- multiple Active Directory domains
 - overview 396
- multiple Identities
 - overview 162

N

- native FTP
 - authentication 93
 - configuring notification messages 277
 - guidelines 92
 - overview 92
 - transparently redirected connections 94
- navigating
 - web interface 19
- negotiating
 - SSL session 206
- Netscape
 - PAC files 107
- network interfaces 485
 - appliance ports 30
 - enabling P2 485
 - M1 30
 - P1 and P2 30
 - T1 and T2 31
 - VLANs 491
- network tap
 - duplex 41, 47
 - simplex 41, 47
- no category (nc) 465
- no score (ns) 465
- notification pages
 - see *end-user notification pages*
- NTLM
 - computer account 398
 - entering a domain 355
 - joining an Active Directory domain 398
 - overview 396
 - testing settings 370

O

- object filtering
 - Access Policies 180
- objects
 - blocking 180, 247
- on-demand reports 437
- Overview report 419

P

- P1 and P2 interfaces
 - overview 30
- P2 port
 - configuring 485
- PAC files
 - configuring browsers 103
 - deployment 33
 - format 102
 - Netscape and Firefox 107
 - overview 102
 - re-authentication 387
 - storing on the appliance 106
 - WPAD 104
- packet capture
 - editing settings 513
 - overview 511
 - starting 512
- pages in the web interface 20
- passing through traffic
 - Decryption Policies 201
- passwords
 - Active Directory 390
 - changing 519
 - creating 517
 - special characters 401
- PER format
 - converting 215
- physical dimensions of appliance 43
- plaintext
 - defined 204
- policies table
 - examples 165
 - overview 130
- policy group member definition
 - Access Policies 172
 - Decryption Policies 221
 - External DLP Policies 239
 - Identities 147
 - IronPort Data Security Policies 239
 - overview 133
 - Routing Policies 193
 - user agent based 138
- policy groups
 - about 126
 - Access Policies 170
 - All Identities 134
 - creating 130
 - custom URL categories 301

-
- Decryption Policies 201
 - evaluating group membership 133
 - External DLP Policies 234
 - global policy group 130
 - guidelines 135
 - IronPort Data Security Policies 234
 - overview 130
 - policies table 130
 - time based 136
 - tracing 141
 - types of policies 127
 - user agent based 138
 - policy types
 - overview 127
 - ports
 - Access Policies 175
 - blocking 179
 - Decryption Policies 224
 - External DLP Policies 243
 - Identities 147
 - IronPort Data Security Policies 243
 - Routing Policies 196
 - see also *network interfaces*
 - private key cryptography
 - defined 205
 - protocols
 - Access Policies 175
 - blocking 179
 - External DLP Policies 242
 - IronPort Data Security Policies 242
 - Routing Policies 196
 - proxy
 - see *web proxy*
 - proxy bypass list
 - about 98
 - using with WCCP 99
 - proxy cache
 - configuring 108
 - proxy groups
 - creating 191
 - public key cryptography
 - defined 204
 - public key infrastructure
 - defined 205
 - R**
 - realms
 - see *authentication realms*
 - re-authentication
 - overview 386
 - using with Internet Explorer 387
 - using with PAC files 387
 - Redirect setting
 - URL categories 304
 - redirecting traffic
 - overview 304
 - regular expressions
 - overview 310
 - using in URL filters 310
 - remote upgrades 540
 - reporting misclassified URLs 263
 - reports
 - Anti-Malware 423
 - archiving 438
 - Client Detail 421
 - Client Malware Risk 421
 - Client Web Activity 421
 - custom date ranges 417
 - exporting data 439
 - interactive display 434
 - L4 Traffic Monitor 420
 - Malware Category 423
 - Malware Threat 423
 - on-demand 437
 - Overview 419
 - return address 524
 - scheduling 435
 - search option 417
 - System Status 426
 - time range for scheduled reports 435
 - uncategorized URLs 424
 - URL Categories 424
 - Web Reputation Filters 425
 - Web Site Activity 422
 - Web Site Detail 422
 - restoring
 - keys for FIPS management 79
 - result codes 458
 - return addresses
 - configuring 524
 - RFC
 - 1065 427
 - 1066 427
 - 1067 427
 - 1213 427
 - 1907 427
 - 2571-2575 427
-

- rolling over log files
 - overview 449
- rollovernow command 449
- root certificate
 - defined 205
- root certificates
 - generating 76, 218
 - importing trusted 231
 - uploading 76, 218
 - using 213
- Routing Policies
 - creating 195
 - failover 189
 - guest users 155
 - load balancing 189
 - membership 193
 - overview 189
 - protocol of request 196
 - proxy port of request 196
 - subnet of request 196
 - time of request 197
 - URL category of request 197
 - user agent of request 197
- Routing Policy groups
 - see also *policy groups*
- routing tables
 - configuring 490
- routing traffic 189

S

- scanning verdicts
 - anti-malware 480
- SCP Push 454
- secure LDAP 390
- see *upstream proxies*
- self-signed certificate
 - defined 205
- SenderBase Network 18
- sequences
 - see *authentication sequences*
- sethostname command
 - overview 484
- setting up the appliance
 - prerequisites 46
- Simple Network Management Protocol
 - see *SNMP*
- simplex
 - deploying the L4 Traffic Monitor 41
 - network tap 47

- single sign-on
 - defined 358
- SMI file
 - SNMP 427
- SNMP
 - community string 427
 - hardware failure trap conditions 428
 - hardware objects 428
 - IPMI 428
 - MIB file 427
 - overview 427
 - SMI file 427
 - SNMPv1 427
 - SNMPv2 427
 - SNMPv3 passphrase 427
 - specifying multiple trap targets 429
 - traps 429
- span port
 - deploying the L4 Traffic Monitor 41
- special characters
 - authentication 401
- splash page
 - web proxy usage agreement 100
- SSH
 - configuring host keys 450
 - FIPS management 69
 - using with the CLI 549
- SSL
 - negotiating a session 206
 - used in HTTPS 206
- SSL ciphers
 - configuring for administrator access 523
- SSL handshake
 - overview 206
- standard service
 - WCCP service 495
- Start Test button
 - overview 371
- streaming upgrades 540
- Submit button 508
- submitting changes
 - configuring the appliance 508
- subnet
 - Access Policies 175
 - Decryption Policies 225
 - External DLP Policies 243
 - IronPort Data Security Policies 243
 - Routing Policies 196
- supportrequest command 509

- surrogates
 - authentication 389
- symmetric key cryptography
 - defined 205
- Syslog 454
- system configuration file 508
- System Setup Wizard
 - logging in 51
 - Network page 52
 - overview 51
 - password 51
 - Review page 63
 - Security page 61
 - Start page 52
 - URL 51
 - username 51
- System Status report 426
- system time 532

T

- T1 and T2 interfaces
 - overview 31
- tabs in web interface 19
- `tail` command 450
- `tcpdump`
 - see *packet capture*
- telnet
 - using with the CLI 549
- `testauthconfig` command 372
- testing authentication settings 370
- threat risk rating 349
- threat risk threshold 349
- time 532
- time based policies
 - overview 136
 - time ranges 136
 - URL Filters 308
- time ranges
 - Access Policies 176
 - creating 136
 - Decryption Policies 225
 - policy groups 136
 - Routing Policies 197
- TLS
 - used in HTTPS 206
- to upstream proxies 189
- tracing policies
 - overview 141

- traffic
 - redirecting 304
- transaction result codes 458
- transparent mode
 - native FTP 94
 - transparent redirection 495
- transparent redirection
 - adding a WCCP service 498
 - assignment method 496
 - forwarding method 497
 - GRE forwarding method 497
 - hash assignment 496
 - L2 forwarding method 497
 - mask assignment 496
 - overview 495
 - WCCP services 495
- troubleshooting
 - policy groups 141
- TRR (Threat Risk Rating) 349
- TRT (Threat Risk Threshold) 349
- trusted root certificates
 - importing 231

U

- uncategorized URLs 289
 - in reports 424
- unlisted address
 - defined 407
- unrecognized root authority
 - invalid certificates 220
- updates
 - manual updates 545
 - overview 539
- upgrades
 - available 537
 - configuring upgrade settings 539
 - overview 537
 - remote 540
 - requirements for local upgrade servers 542
 - streaming 540
- upgrading
 - AsyncOS 537
- upload request
 - defined 236
- uploading
 - certificate files 77, 219
 - root certificates 76, 218
 - root certificates for HTTPS 213

- upstream proxies
 - adding proxy information 191
 - authentication 355
 - creating proxy groups 191
 - deployment 40
 - overview 188
 - routing traffic 189

- URL
 - Access Policies 176
 - Decryption Policies 225
 - External DLP Policies 243
 - Identity groups 147
 - IronPort Data Security Policies 243
 - Routing Policies 197

- URL categories 306
 - abbreviations 313
 - blocking 179, 246
 - descriptions 313
 - redirecting traffic 304
 - uncategorized URLs 424

- URL Categories report 424

- URL Filters
 - bypassing 98
 - configuring 292
 - custom categories 301
 - database 290
 - Dynamic Content Analysis engine 288
 - enabling 291
 - no category 289
 - regular expressions 310
 - time based 308
 - URL category descriptions 313
 - viewing filtering activity 309

- URL processing
 - L4 Traffic Monitor 407

- user accounts
 - about 517
 - managing 517
 - types of 518

- user agent
 - Decryption Policies 225
 - Identity groups 147
 - Routing Policies 197

- user agent based policies
 - overview 138

- user agents
 - Access Policies 176
 - blocking 179
 - creating policies 138

- exempting from authentication 140
 - External DLP Policies 244
 - file types 184
 - instant messenger 182
 - IronPort Data Security Policies 244
 - objects 184
 - peer-to-peer 184
 - user defined notification pages
 - example 270
 - overview 269
 - parameters 269
 - user name 518
 - user password length 517
 - user passwords 519
 - user types 518

V

- validating
 - certificates 210
- validating certificate authorities 208
- VLAN

- defined 491
 - etherconfig command 492
 - example use 491
 - interfaceconfig command 493
 - labels 491
 - overview 491

W

- W3C access logs
 - custom fields 479
 - custom formatting 470
 - log fields 468
 - overview 467
 - user defined log fields 479
- warning page
 - end-user URL category page 276
- warning users 306
 - configuring end-user warning page 276
 - using URL categories 306
- WBRS
 - see also *Web Reputation Filters*
- WCCP
 - bypassing the web proxy 99
- WCCP cluster
 - overview 39
- WCCP configuration
 - example configuration 37
 - syntax 36

-
- WCCP router
 - cluster 39
 - configuration syntax 36
 - configuring 35
 - connecting to the appliance 46
 - deploying the appliance 35
 - multiple 39
 - WCCP services 495
 - WCCP services
 - adding 498
 - assignment method 496
 - deleting 501
 - dynamic service 495
 - editing 498
 - forwarding method 497
 - IP spoofing 497
 - overview 495
 - standard service 495
 - well known service 495
 - web browsers
 - configuring 103
 - detecting PAC files automatically 104
 - PAC files 103
 - supported 21
 - web interface
 - browser requirements 21
 - clearing changes 25
 - committing changes 25
 - FIPS management 69
 - logging in 21
 - navigating 19
 - pages 20
 - tabs 19
 - user name and password 21
 - web proxy
 - advanced configuration 108
 - bypassing 98
 - cache 86
 - cache, configuring 108
 - deploying 28
 - deploying in explicit forward mode 33
 - deploying in transparent mode 34
 - existing 40
 - overview 86
 - splash page 100
 - usage agreement 100
 - Web Proxy Autodiscovery Protocol
 - see *WPAD*
 - web proxy cache
 - modifying 86
 - removing a URL from the cache 86
 - Web Reputation Filters
 - about 330
 - access log file 338
 - access log information 462
 - bypassing 98
 - configuring Access Policies 335
 - database 330
 - how it works 333
 - report 425
 - scores 331
 - viewing activity 338
 - Web Security appliance
 - physical dimensions 43
 - user name and password 21
 - Web Site Activity report 422
 - Webroot scanning engine
 - database 342
 - overview 345
 - weight of appliance 43
 - welcome page
 - web proxy usage agreement 100
 - well known service
 - WCCP service 495
 - whitelist address
 - see *known allowed address*
 - who command 520
 - whoami command 520
 - width of appliance 43
 - Windows domain
 - entering for authentication 355
 - WPAD
 - detecting PAC files 104
 - Internet Explorer 104
 - using with Netscape and Firefox 107
 - using with the appliance 106
- X**
- X.509
 - standard for certificates 205
-

